

GOLD RUSH

Member IMC Group
Ingersoll
Cutting Tools

GENERAL PRODUCT CATALOG





Milling Tools

Page 6

- 0° End Mills..... Page 10
- Long-Edge End Mills..... Page 66
- 0° Face MillsPage 106
- Lead Angle Face Mills.....Page 162
- Slotting Mills.....Page 204
- Lead Angle & Form Mills.....Page 220
- Profile, Hi-Feed & Plunging MillsPage 238
- Technical Information
(Indexable Milling Cutters).....Page 302
- Solid Carbide Milling Cutters.....Page 386
- Technical Information (Solid Carbide Cutters).....Page 448

Thread & Boring Tools

Page 474

- Boring ToolsPage 478
- Threading.....Page 481
- Deep-Hole DrillingPage 483
- BTA System.....Page 483
- Technical InformationPage 666



Adaptions

Page 720

- Inno-Fit & Top-On Toolholders Page 724
- HSK Toolholders..... Page 740
- Cat Toolholders Page 776
- BT Toolholders Page 798
- Special Adaptions & Accessories Page 818

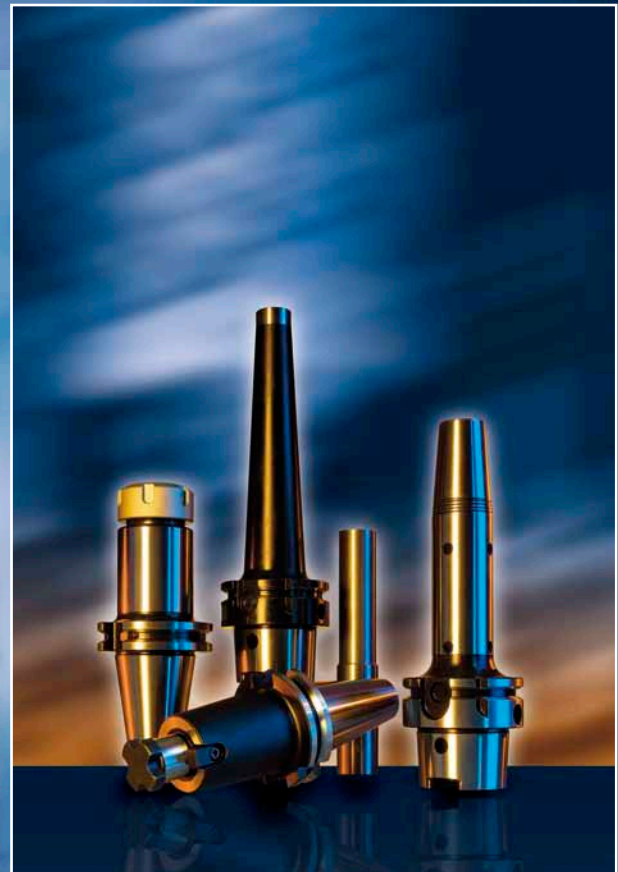

Turning, Thread Turning & Grooving

Page 872

- TurningPage 874
 - Turning InsertPage 878
 - Turning Holders & Boring Bars.....Page 1032
 - Technical Information.....Page 1144
- Thread Turning
 - Threading InsertsPage 1178
 - Threading Tool HoldersPage 1244
 - Technical Information.....Page 1256
- T-Clamp
 - T-Clamp InsertsPage 1272
 - T-Clamp Holders.....Page 1300
 - Technical Information.....Page 1344
- T-CAP.....Page 1378
 - Technical Information.....Page 1388

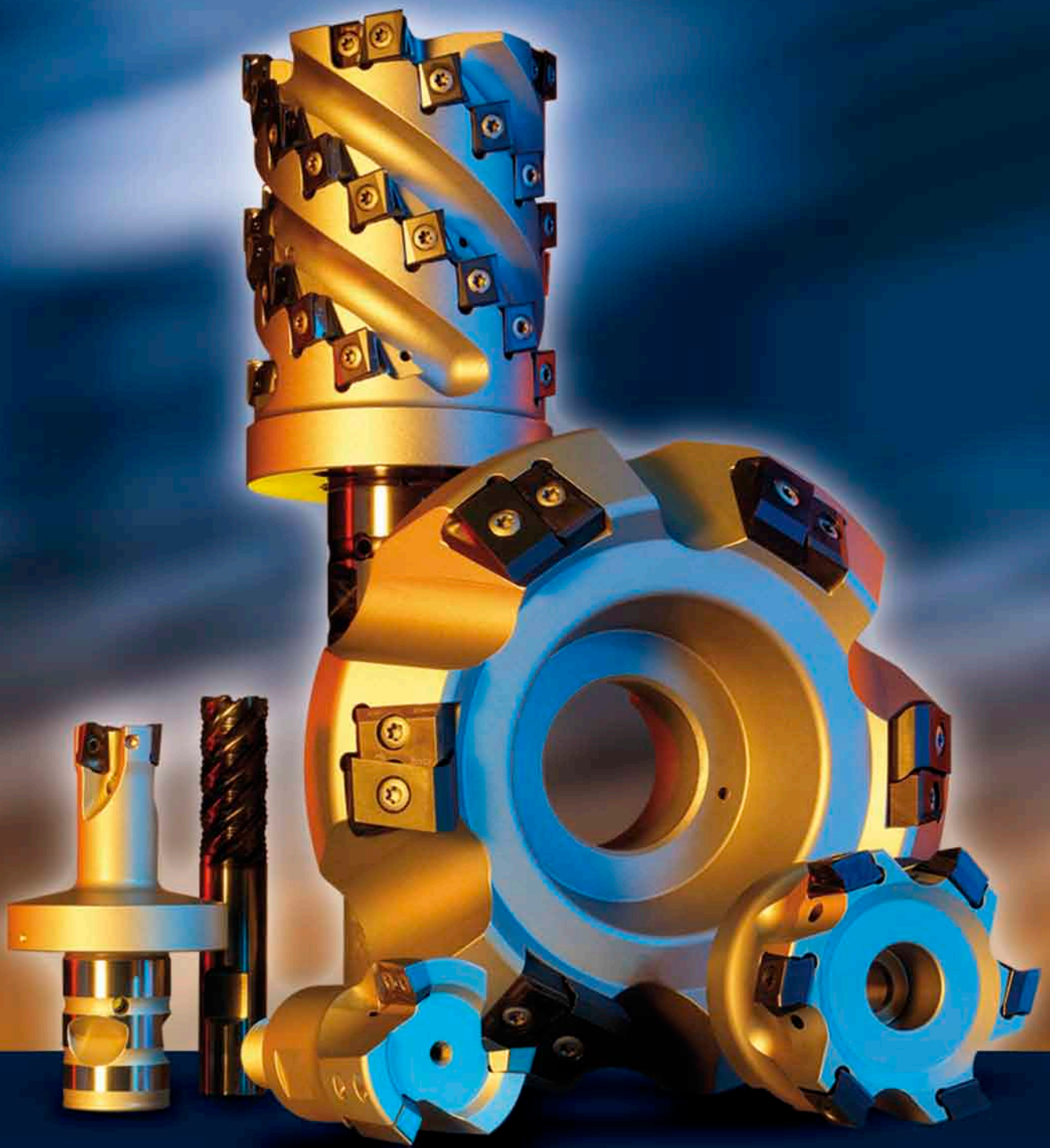

Ingersoll

0° END MILLS

LONG-EDGE END MILLS

0° FACE MILLS

LEAD ANGLE FACE MILLS

SLOTTING MILLS

LEAD ANGLE & FORM MILLS

PROFILE, HI FEED & PLUNGING MILLS

SOLID CARBIDE MILLING CUTTERS

THREAD & BORING TOOLS

Ingersoll



CUTTING TOOLS
CUTTING TOOLS

0° END MILLS.

Cutting Tools

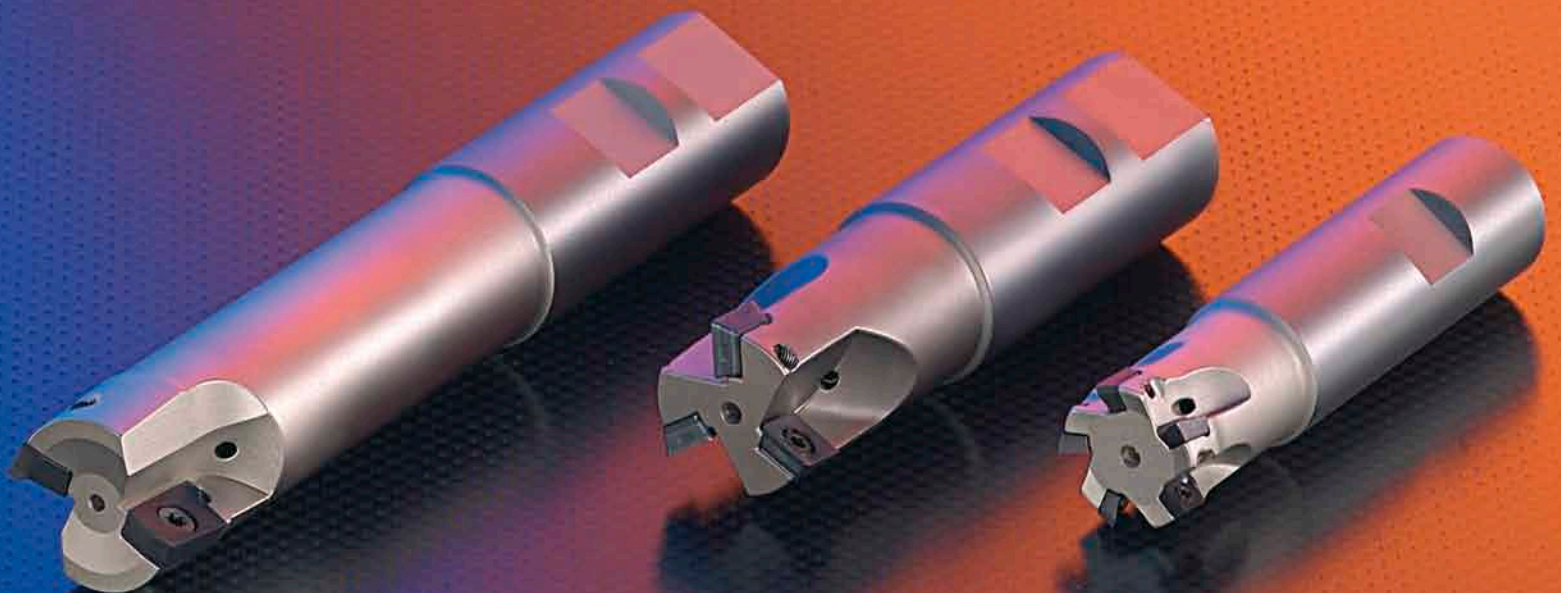

Member IMC Group
Ingersoll
Cutting Tools

0° END MILLS.

	Diameter	Depth of Cut	Description	Series	Page
	.375 - 1.000	.22	Hi-POS® 0° Lead End Mill	12J1D	14
	.750 - 2.000	.22	Hi-POS® 0° Lead End Mill Shank for Live Tooling & Swiss	12J1D (Straight Shank)	16
	.500 - 1.500	.22	Hi-POS® 0° Lead End Mill	12J1D (Top-On Style)	17
	.375 - .750	.22	Hi-POS® 0° Lead End Mill	12J1D (Chip-Surfer Style)	18
	.500 - 1.500	.25	Hi-POS+ 0° Lead End Mill	12J1P	20
	.625 - 1.250	.35	Hi-POS+ 0° Lead End Mill	12J1P (Top-On Style)	22
	.725 - 1.500	.50	Hi-POS+ 0° Lead End Mill	12J1X	24
	2.000	.21	Hi-POS+ 15° Lead End Mill	12R1X	26
	.750 - 1.500	.50	Hi-POS+ 0° Lead End Mill	12J1X (Top-On Style)	28
	.750 - 1.500	.50	Hi-POS+ Back Drafted End Mill	12V1X (Top-On Style)	30

	Diameter	Cutting Depth	Description	Series	Page
	.750 - 1.500	.50	HI-POS+ 0° Lead End Mill	12J1R	32
	.750 - 2.000	.63	HI-POS+ 0° Lead End Mill	12J1G	34
	1.000 - 1.250	.60	HI-POS+ 0° Lead End Mill	12J1G (Top-On Style)	36
	.970 - 2.000	.66	HI-POS+ 0° Lead End Mill	12J1E, 12J4E	38
	1.000 - 1.250	.66	HI-POS+ 0° Lead End Mill	12J1E (Top-On Style)	40
	1.250 - 2.000	.59	TETRA 0° Lead End Mill	1TJ1N	42
	1.250 - 1.500	.59	TETRA 0° Lead End Mill	1TJ1N (Top-On Style)	43
	.750 - 1.500	.31	EVO-TEC MINI 0° Lead End Mill	1SJ1Y	44
	.750 - 1.500	.31	EVO-TEC MINI 0° Lead End Mill	1SJ1Y (Top-On Style)	46
	.750 - 1.000	.31	EVO-TEC MINI 0° Lead End Mill	1SJ1Y (Chip Surfer Style)	47

0° END MILLS.

	Diameter	Cutting Depth	Description	Series	Page
	1.000 - 1.500	.42	EVO•TEC 0° Lead End Mill	1SJ1F	48
	1.000 - 1.500	.42	EVO•TEC 0° Lead End Mill (Top-On Style)	1SJ1F (Top-On Style)	50
	.625 - 1.250	.31	HI•POSQUAD 0° Lead End Mill	15J1E	52
	.750 - 1.500	.61	ROUGH•AIR 0° Lead High-Speed Router End Mill (Aluminum)	15X1W	54
	1.500 - 3.000	.61	ROUGH•AIR 0° Lead High-Speed Router End Mill (Aluminum) (HSK Adaption)	15X1W (HSK Adaption)	56
	.750 - 1.500	.61	ROUGH•AIR 0° Lead High-Speed Router End Mill (Aluminum) (Top-On Style)	15X1W (Top-On Style)	57
	1.000 - 2.000	.62	ROUGH•AIR 0° Lead High-Speed Router End Mill (Aluminum)	15X1X	58
	1.250 - 1.500	.82	ROUGH•AIR 0° Lead High-Speed Router End Mill (Aluminum) (Top-On Style)	15X1X (Top-On Style)	59
	2.000	.99	ROUGH•AIR 0° Lead High-Speed Router End Mill (Aluminum)	15X1Z	60
	1.000 - 2.000	.43	ALUMINATOR 0° Lead High-Speed Router End Mill (Aluminum)	15U1G	62

	Diameter	Cutting Depth	Description	Series	Page
	1.000 - 1.500	.41	ALUMINATOR 0° Lead High-Speed Router End Mill (Aluminum)	15U1G (Top-On Style)	63

0 DEGREE LEAD END MILL

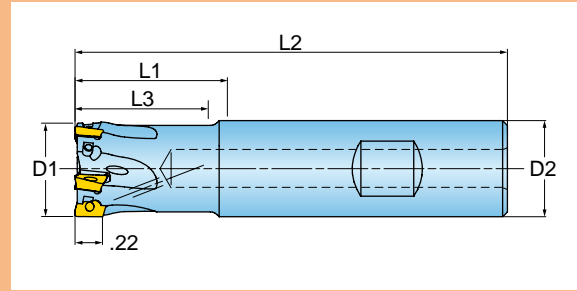

Cutter Number	D1 Nom. Dia.	L1 Extension Length	L2 Overall Length	L3 Projection Length	D2 Shank Size/Style	Number of Inserts	Ramp Angles
12J1D-0300587R01	0.375	0.72	2.50	0.52	.500" Weldon	2	9.6
12J1D-03009R8R01	0.375	1.00	2.50	0.90	.375" Cylindrical	2	9.6
12J1D-04009S4R01	0.490	1.00	2.75	0.90	.500" Cylindrical	2	6.0
12J1D-05009S4R01	0.500	1.00	2.75	0.90	.500" Cylindrical	3	6.0
12J1D-0500979R01	0.500	1.09	3.00	0.90	.625" Weldon	3	6.0
12J1D-05011S4R01	0.500	1.25	3.00	1.15	.500" Cylindrical	2	6.0
12J1D-0601479R01	0.620	0.72	2.50	0.52	.625" Weldon	4	4.0
12J1D-06014S6R01	0.620	1.50	6.00	1.40	.625" Cylindrical	3	Not Recomm.
12J1D-0701684R02	0.720	1.75	3.75	1.65	.750" Weldon	4	2.6
12J1D-0701684R01	0.750	1.75	3.75	1.65	.750" Weldon	5	2.6
12J1D-07016S7R01	0.750	1.75	6.00	1.65	.750" Weldon	4	Not Recomm.
12J1D-0801784R01	0.875	1.75	3.75	1.75	.750" Weldon	5	2.3
12J1D-1001784R01	1.000	1.75	3.75	1.75	.750" Weldon	7	1.9
12J1D-1001784R02	1.000	1.75	3.75	1.75	.750" Weldon	5	1.9
12J1D-1001780R01	1.000	1.75	4.00	1.75	1.000" Weldon	7	1.9
12J1D-1001780R02	1.000	1.75	4.00	1.75	1.000" Weldon	5	1.9
12J1D-10021S1R01	1.000	2.25	8.00	2.15	1.000" Cylindrical	5	Not Recomm.
12J1D-1003480R01	1.000	3.50	5.75	3.40	1.000" Weldon	5	Not Recomm.

Operating guidelines on [347](#).



INSERTS

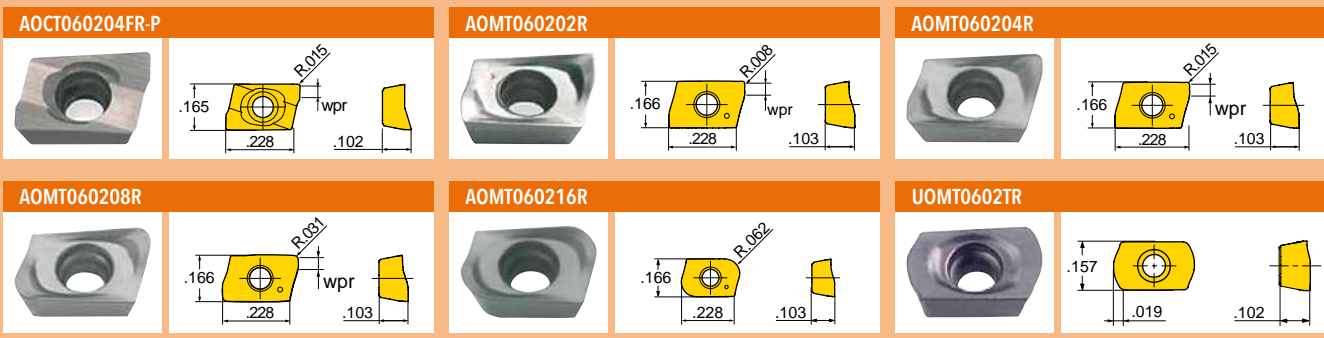

Part Number	Applications	Grade											
			IN05S	IN1030	IN2005	IN2030	IN2505						
AOCT060204FR-P	Grd/Pol for Al - 0.015" R		●										
AOMT060202R	Multi-Purpose - 0.008" R			●	●	●							
AOMT060204R	Multi-Purpose - 0.015" R				●	●	●						
AOMT060208R	Multi-Purpose - 0.031" R				●	●	●						
AOMT060216R*	Multi-Purpose - 0.062" R				●	●	●						
UOMT0602TR	High-Feed - 0.040" R**					●	●						

* Cutter body must be relieved to accept R. 062
 ** Programming Radius

● = P ● = M ● = K ● = N ○ = S

Hardware				
	Screw	Driver	Opt. Torque Driver Handle	Opt. Bit for DTN005S
	SM18-041-00	DS-TP06S	DTN005S	DS-TP06TB

HIPOPOS™ SERIES 12J1D (STRAIGHT SHANK)

0 DEGREE LEAD END MILL
SHANK FOR LIVE TOOLING & SWISS

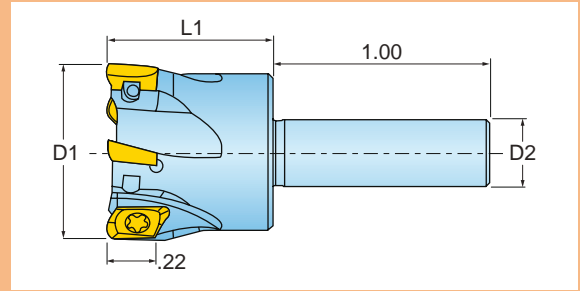

Cutter Number	D1 Nominal Diameter	L1 Extension Length	D2 Shank Size/Style	Number of Inserts	Ramp Angle
12J1D-07007R8R01	0.750	0.75	.375" Cylindrical	5	2.6
12J1D-10007R8R01	1.000	0.75	.375" Cylindrical	5	1.9
12J1D-15007S4R01	1.500	0.75	.500" Cylindrical	7	1.2
12J1D-20007S6R01	2.000	0.75	.625" Cylindrical	7	.4

Operating guidelines on 347.

INSERTS

AOCT060204FR-P 	AOMT060202R 	AOMT060204R
AOMT060208R 	AOMT060216R 	UOMT0602TR

Part Number	Applications	Grade									
			IN05S	IN1030	IN2005	IN2030	IN2505				
AOCT060204FR-P	Grd/Pol for Al - 0.015" R		●								
AOMT060202R	Multi-Purpose - 0.008" R			●	●	●					
AOMT060204R	Multi-Purpose - 0.015" R			●	●	●	●				
AOMT060208R	Multi-Purpose - 0.031" R			●	●	●	●				
AOMT060216R*	Multi-Purpose - 0.062" R			●	●	●	●				
UOMT0602TR	High-Feed - 0.040" R**					●	●				

* Cutter body must be relieved to accept R. 062

** Programming Radius

● = P ● = M ● = K ● = N ○ = S

HARDWARE



SM18-041-00 DS-TP06S DS-TP06TB DTN005S

HIPOPOS™ SERIES 12J1D (TOP-ON STYLE)

0 DEGREE LEAD END MILL

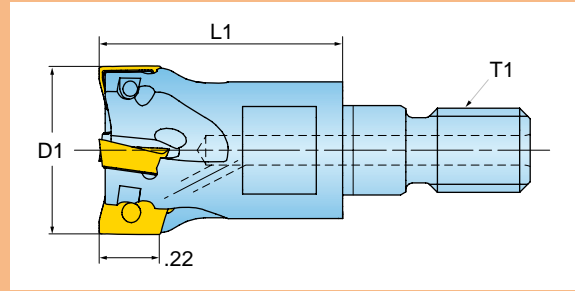

Cutter Number	D1 Nom. Dia.	T1 Adaption	L1 Extension Length	Number of Inserts	Wrench Size	Ramp Angle
12J1D-05010X4R01	0.500	M6	1.00	3	7mm	6.0
12J1D-06010X5R01	0.620	M8	1.00	4	10mm	4.0
12J1D-07015X6R01	0.750	M10	1.50	5	15mm	2.6
12J1D-10015X7R01	1.000	M12	1.50	7	17mm	1.9
12J1D-12017X8R01	1.250	M16	1.75	8	22mm	1.6
12J1D-15017X8R01	1.500	M16	1.75	9	22mm	1.2

For Top-On shanks and adaptors, see pages 730-737.
Operating guidelines on 347.

INSERTS

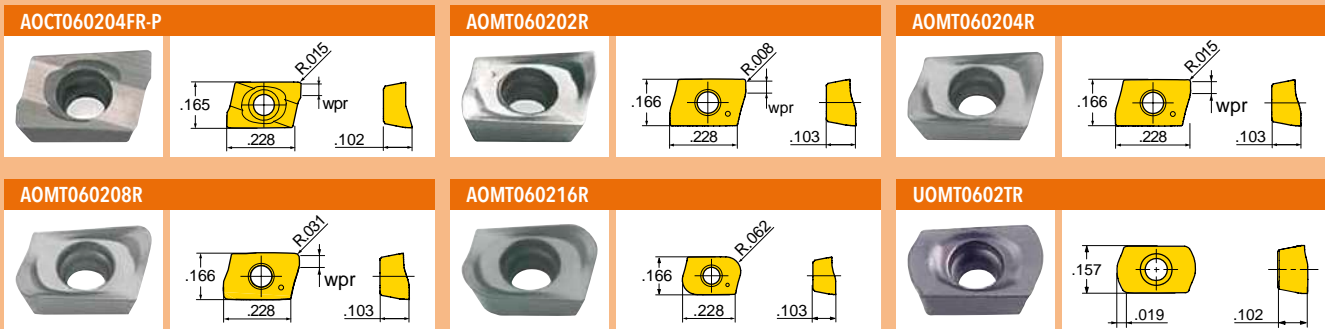

Part Number	Applications	Grade										
			IN05S	IN1030	IN2005	IN2030	IN2505					
AOCT060204FR-P	Grd/Pol for Al - 0.015" R		●									
AOMT060202R	Multi-Purpose - 0.008" R			●	●	●						
AOMT060204R	Multi-Purpose - 0.015" R				●	●	●					
AOMT060208R	Multi-Purpose - 0.031" R				●	●	●					
AOMT060216R*	Multi-Purpose - 0.062" R				●	●						
UOMT0602TR	High-Feed - 0.040" R**					●	●					

* Cutter body must be relieved to accept R. 062
** Programming Radius

● = P ○ = M ● = K ● = N ○ = S

HARDWARE

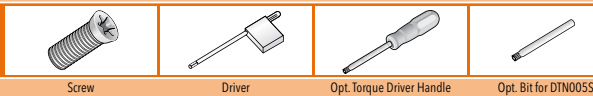

SM18-041-00 DS-TP06S DTN005S DS-TP06TB

HI-POS™ SERIES 12J1D (CHIP-SURFER STYLE)

0 DEGREE LEAD END MILL

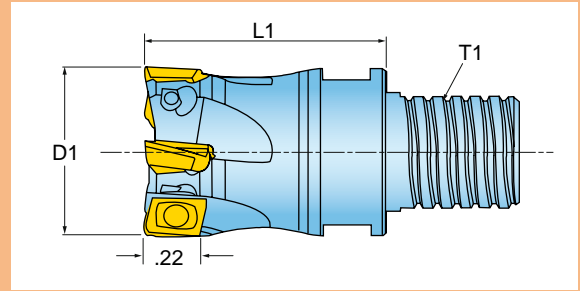

Cutter Number	D1 Nominal Diameter	# Inserts	T1 Thread Size	L1 Extension Length	Ramp Angle
12J1D-03006T6R01	0.375	2	T06	0.63	9.6
12J1D-05006T8R01	0.500	2	T08	0.65	6
12J1D-05006T8R02	0.500	3	T08	0.65	6
12J1D-06008TRR01	0.625	4	T10	0.80	4
12J1D-07010TSR01	0.750	5	T12	1.00	2.6
12J1D-07010TSR02	0.750	3	T12	1.00	2.6

For Chip-Surfer shank selection, see [page 422](#).
Operating guidelines on [347](#).



INSERTS

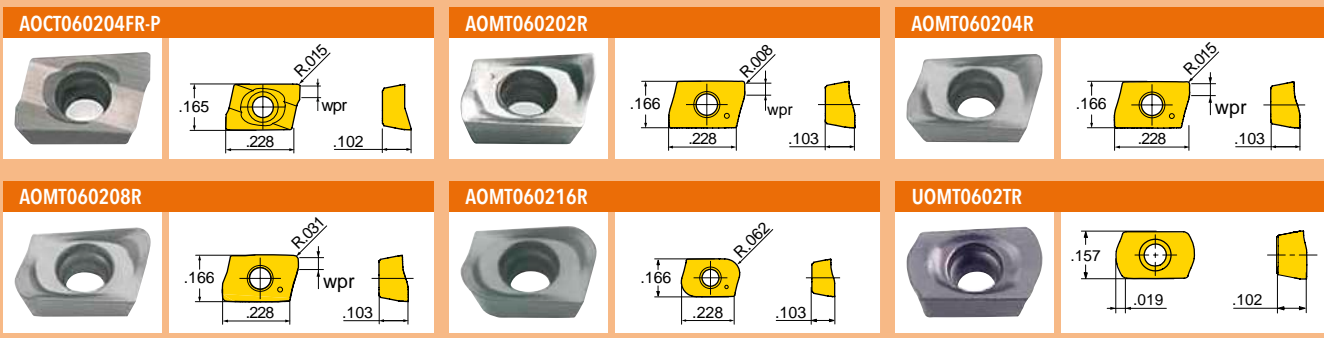





Part Number	Applications	Grade									
			IN05S	IN1030	IN2005	IN2030	IN2505				
AOCT060204FR-P	Grd/Pol for Al - 0.015" R		●								
AOMT060202R	Multi-Purpose - 0.008" R			●	●	●					
AOMT060204R	Multi-Purpose - 0.015" R			●	●	●	●				
AOMT060208R	Multi-Purpose - 0.031" R			●	●	●	●				
AOMT060216R**	Multi-Purpose - 0.062" R			●	●	●	●				
UOMT0602TR	High-Feed - 0.040" R*					●	●				

* Programming Radius
 ** Cutter body must be relieved to accept R .062"

● = P ● = M ● = K ● = N ○ = S

HARDWARE

					
	Screw	Driver	Wrench	Opt. Bit for DTN005S	Opt. Torque Driver Handle
12J1D-03006T6R01	SM18-041-00	DS-TP06S	WS-0029	DS-TP06TB	DTN005S
12J1D-05006T8R01	SM18-041-00	DS-TP06S	WS-0030	DS-TP06TB	DTN005S
12J1D-05006T8R02	SM18-041-00	DS-TP06S	WS-0030	DS-TP06TB	DTN005S
12J1D-06008TRR01	SM18-041-00	DS-TP06S	WS-0044	DS-TP06TB	DTN005S
12J1D-07010TSR01	SM18-041-00	DS-TP06S	WS-0059	DS-TP06TB	DTN005S
12J1D-07010TSR02	SM18-041-00	DS-TP06S	WS-0059	DS-TP06TB	DTN005S

0 DEGREE LEAD END MILL

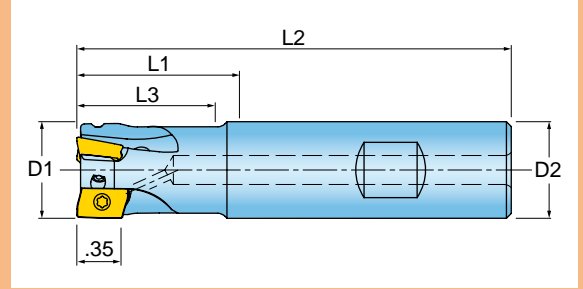

Cutter Number	D1 Nominal Diameter	L1 Extension Length	L2 Overall Length	L3 Projection Length	D2 Shank Size/Style	Number of Inserts	Ramp Angle
12J1P-0501379R01	0.500	1.34	3.25	1.18	.625" Weldon	1	12.5
12J1P-0601379R01	0.625	1.34	3.25	1.18	.625" Weldon	2	11
12J1P-0701784R01	0.750	1.75	3.25	1.18	.750" Weldon	2	8
12J1P-0701784R02	0.750	1.75	3.25	1.18	.750" Weldon	3	8
12J1P-0702784R01	0.750	2.75	4.75	2.75	.750" Weldon	2	8
12J1P-0704084R01	0.750	4.00	6.00	2.75	.750" Weldon	2	Not Recomm.
12J1P-0801784R01	0.875	1.75	3.75	1.18	.750" Weldon	3	5.5
12J1P-1001784R01	1.000	1.75	3.75	1.75	.750" Weldon	3	4
12J1P-1001784R02	1.000	1.75	3.75	1.75	.750" Weldon	4	4
12J1P-1201584R01	1.250	1.50	3.75	1.50	.750" Weldon	5	2.5
12J1P-1501780R01	1.500	1.75	4.00	1.75	1.000" Weldon	6	2

Operating guidelines on [349](#).

INSERTS

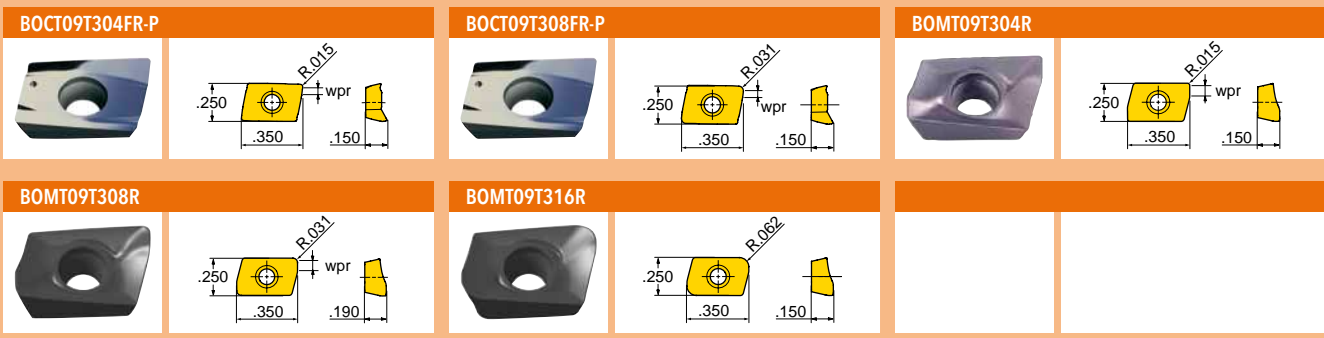

Part Number	Applications	Grade	IN10K	IN2030	IN2505						
BOCT09T304FR-P	Grd/Pol for Al - 0.015" R		●								
BOCT09T308FR-P	Grd/Pol for Al - 0.031" R		●								
BOMT09T304R	Multi-Purpose - 0.015" R			●	●						
BOMT09T308R	Multi-Purpose - 0.031" R			●	●						
BOMT09T316R	Multi-Purpose - 0.062" R			●	●						

● = P ● = M ● = K ● = N ○ = S

HARDWARE



Screw



Driver

12J1P-0501379R01	SM25-054-00	DS-T08W
12J1P-0601379R01	SM25-054-00	DS-T08W
12J1P-0701784R01	SM25-064-00	DS-T08W
12J1P-0701784R02	SM25-064-00	DS-T08W
12J1P-0702784R01	SM25-064-00	DS-T08W
12J1P-0704084R01	SM25-064-00	DS-T08W
12J1P-0801784R01	SM25-064-00	DS-T08W
12J1P-1001784R01	SM25-064-00	DS-T08W
12J1P-1001784R02	SM25-064-00	DS-T08W
12J1P-1201584R01	SM25-064-00	DS-T08W
12J1P-1501780R01	SM25-064-00	DS-T08W

HIPOST[™] SERIES 12J1P (TOP-ON STYLE)

0 DEGREE LEAD END MILL

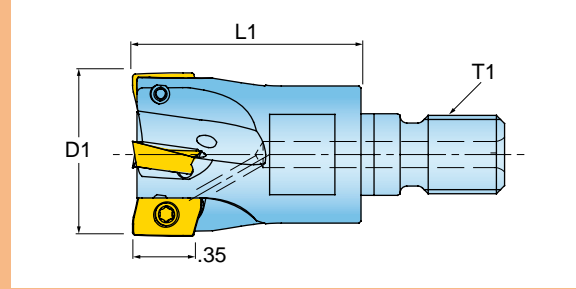

Cutter Number	D1 Nom. Dia.	T1 Adaption	L1 Extension Length	Number of Inserts	Wrench Size	Ramp Angle
12J1P-06015X5R01	0.625	M8	1.50	2	10mm	11
12J1P-07015X6R01	0.750	M10	1.50	3	15mm	8
12J1P-10015X7R01	1.000	M12	1.50	4	17mm	4
12J1P-12017X8R01	1.250	M16	1.75	5	22mm	2.5

For Top-On shanks and adaptors, see [pages 730-737](#).
Operating guidelines on [349](#).

INSERTS

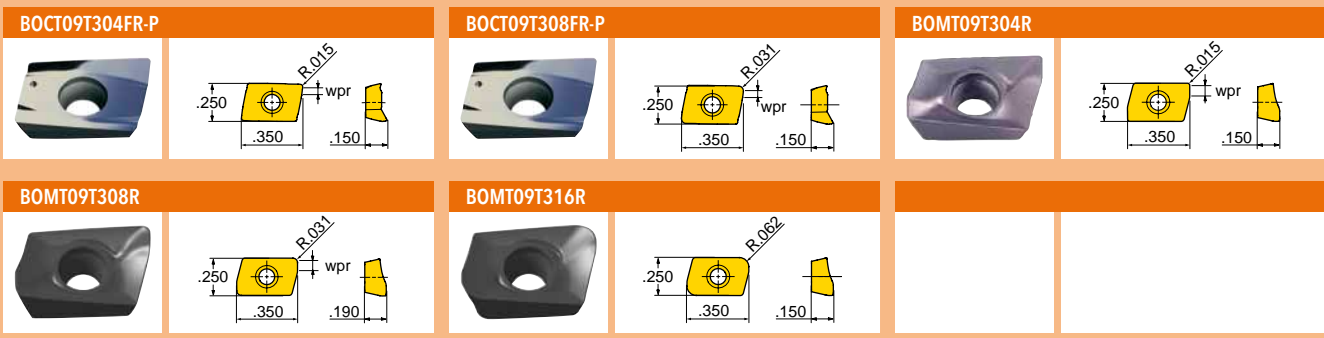

Part Number	Applications	Grade	IN10K	IN2030	IN2505						
BOCT09T304FR-P	Grd/Pol for Al - 0.015" R		●								
BOCT09T308FR-P	Grd/Pol for Al - 0.031" R		●								
BOMT09T304R	Multi-Purpose - 0.015" R			●	●						
BOMT09T308R	Multi-Purpose - 0.031" R			●	●						
BOMT09T316R	Multi-Purpose - 0.062" R			●	●						

● = P ● = M ● = K ● = N ○ = S

HARDWARE



Screw



Driver

12J1P-06015X5R01	SM25-054-00	DS-T08W
12J1P-07015X6R01	SM25-064-00	DS-T08W
12J1P-10015X7R01	SM25-064-00	DS-T08W
12J1P-12017X8R01	SM25-064-00	DS-T08W

0 DEGREE LEAD END MILL

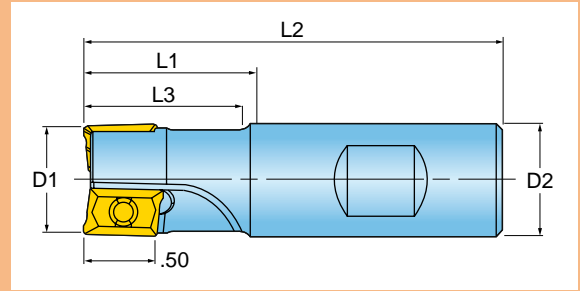

Cutter Number	D1 Nom. Dia.	L1 Extension Length	L2 Overall Length	L3 Projection Length	D2 Shank Size/Style	Number of Inserts	Ramp Angle
12J1X-0702084R01	0.725	2.00	4.00	1.80	.750" Weldon	2	7.0
12J1X-0701184R01	0.750	1.25	3.25	1.05	.750" Weldon	2	7.0
12J1X-0701784R01	0.750	1.75	3.75	1.55	.750" Weldon	2	7.0
12J1X-0703084R01	0.750	3.00	5.00	2.80	.750" Weldon	2	7.0
12J1X-0705780R01	0.750	5.75	8.00	5.55	1.000" Weldon	2	Not Recommended
12J1X-0801784R01	0.875	1.75	3.75	1.75	.750" Weldon	2	5.5
12J1X-1001784R01	1.000	1.75	3.75	1.75	.750" Weldon	3	4.5
12J1X-1001780R01	1.000	1.75	4.00	1.55	1.000" Weldon	3	4.5
12J1X-1003780R01	1.000	3.75	6.00	3.55	1.000" Weldon	3	Not Recommended
12J1X-1201784R01	1.250	1.75	3.75	1.75	.750" Weldon	4	3.5
12J1X-1201780R01	1.250	1.75	4.00	1.75	1.000" Weldon	4	3.5
12J1X-1501784R01	1.500	1.75	3.75	1.75	.750" Weldon	4	2.0
12J1X-1502281R01	1.500	2.25	4.50	2.25	1.250" Weldon	4	2.0

Operating guidelines on [346](#).



INSERTS

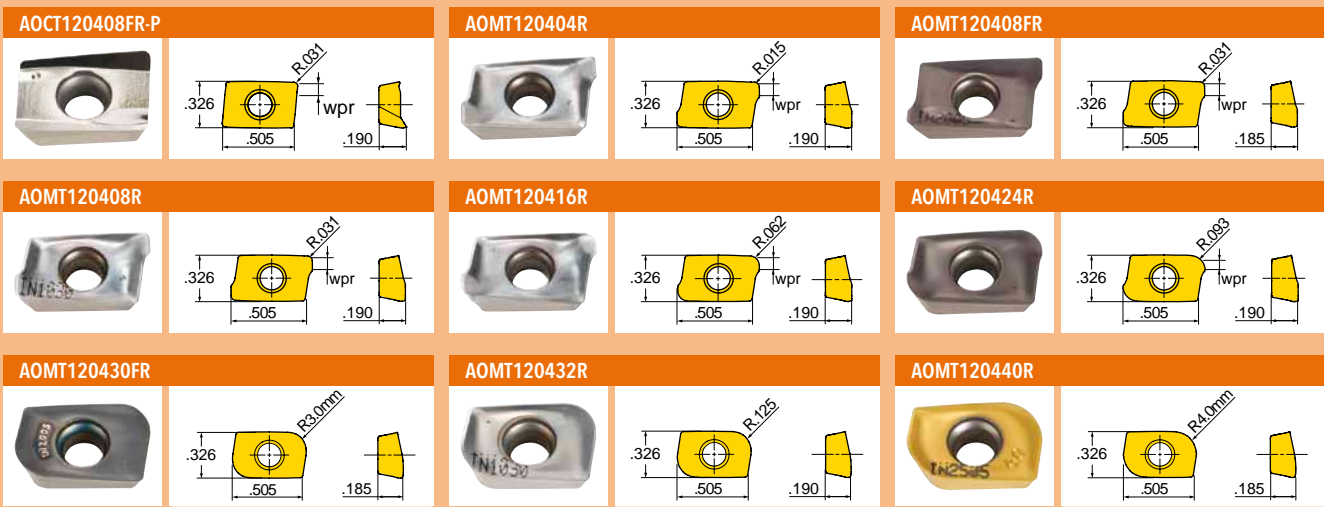

Part Number	Applications	Grade							
		IN1030	IN10K	IN2005	IN2010	IN2030	IN2040	IN2505	IN2510
AOCT120408FR-P	Grd/Pol for Al - 0.031" R		●						
AOMT120404R	Multi-Purpose - 0.015" R	●		●					
AOMT120408FR	Hi-Temp/Ti - 0.031" R			●		●			
AOMT120408R	Multi-Purpose - 0.031" R	●		●	●	●	●	●	
AOMT120416R	Multi-Purpose - 0.062" R	●		●		●			●
AOMT120424R	Multi-Purpose - 0.093" R			●		●			
AOMT120430FR	Multi-Purpose - 3.000 mm R			●					
AOMT120432R	Multi-Purpose - 0.125" R	●		●	●	●	●		
AOMT120440R*	Multi-Purpose - 4.000 mm R							●	

* Cutter body must be relieved to accept R 4.000mm

● = P ● = M ● = K ● = N ○ = S

HARDWARE



Screw Driver

SM35-076-10 DS-T10T



HIPOPOS⁺ SERIES 12R1X

15 DEGREE LEAD END MILL

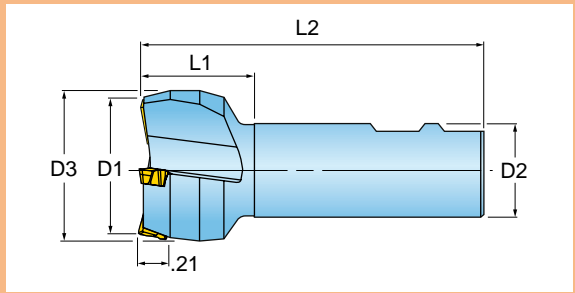

Cutter Number	D1 Nom. Dia.	L1 Extension Length	L2 Overall Length	D2 Bore Diameter	D3 Overall Dia.	Number of Inserts
12R1X-2001084R01	2.000	1.00	3.00	.750" Weldon	2.15	3

Operating guidelines on [346](#).



INSERTS

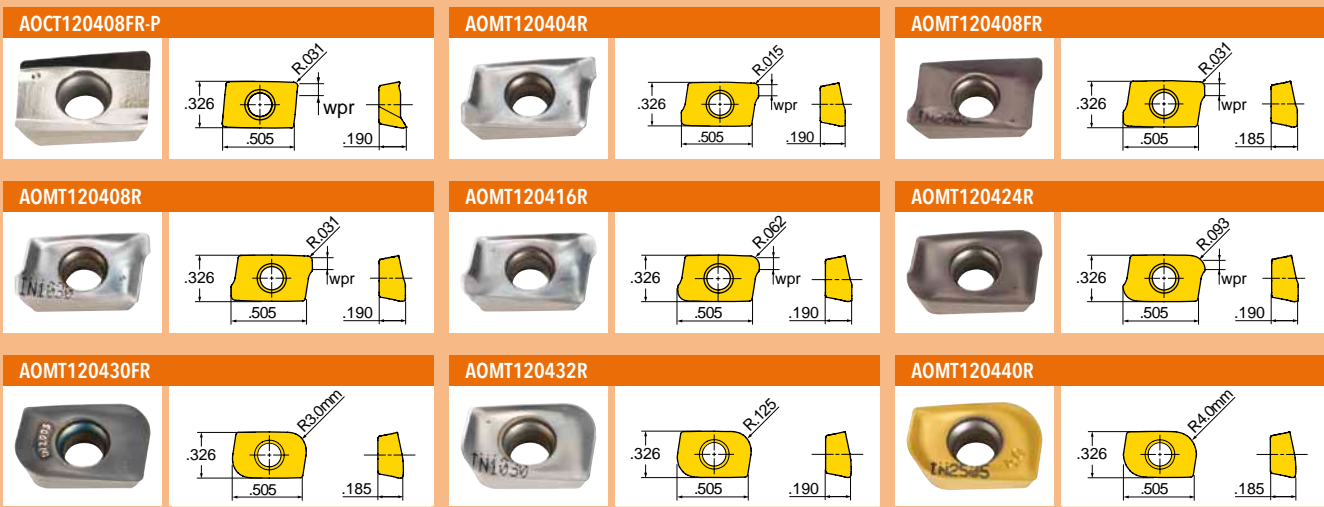

Part Number	Applications	Grade	IN1030	IN10K	IN2005	IN2010	IN2030	IN2040	IN2505	IN2510
			AOCT120408FR-P	Grd/Pol for Al - 0.031" R			●			
AOMT120404R	Multi-Purpose - 0.015" R		●		●					
AOMT120408FR	Hi-Temp/Ti - 0.031" R				●		●			
AOMT120408R	Multi-Purpose - 0.031" R		●		●	●	●	●	●	
AOMT120416R	Multi-Purpose - 0.062" R		●		●		●			●
AOMT120424R	Multi-Purpose - 0.093" R				●		●			
AOMT120430FR	Multi-Purpose - 3.000 mm R				●					
AOMT120432R	Multi-Purpose - 0.125" R		●		●	●	●	●		
AOMT120440R	Multi-Purpose - 4.000 mm R								●	

● = P ● = M ● = K ● = N ○ = S

HARDWARE



Screw Driver

SM35-076-10 DS-T10T

HIOPUS⁺ SERIES 12J1X (TOP-ON STYLE)

0 DEGREE LEAD END MILL

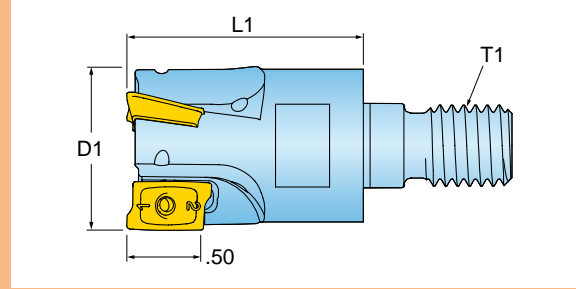

Cutter Number	D1 Nom. Dia.	T1 Adaption	L1 Extension Length	Number of Inserts	Wrench Size	Ramp Angle
12J1X-07015X6R01	0.750	M10	1.50	2	15mm	7
12J1X-10015X7R01	1.000	M12	1.50	3	17mm	4.5
12J1X-12017X8R01	1.250	M16	1.75	4	22mm	3.5
12J1X-15017X8R01	1.500	M16	1.75	5	22mm	2.0

For Top-On shanks and adaptors, see [pages 730-737](#).
Operating guidelines on 346.



INSERTS <?> <?>

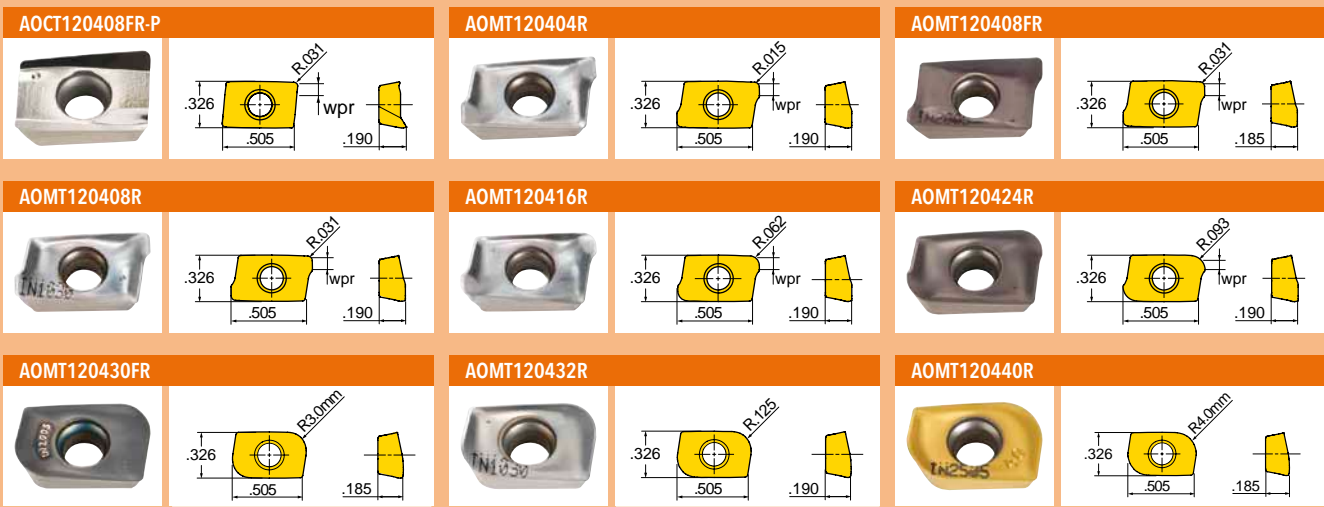

Part Number	Applications	Grade							
		IN1030	IN10K	IN2005	IN2010	IN2030	IN2040	IN2505	IN2510
AOCT120408FR-P	Grd/Pol for Al - 0.031" R		●						
AOMT120404R	Multi-Purpose - 0.015" R	●		●					
AOMT120408FR	Hi-Temp/Ti - 0.031" R			●		●			
AOMT120408R	Multi-Purpose - 0.031" R	●		●	●	●	●	●	
AOMT120416R	Multi-Purpose - 0.062" R	●		●		●			●
AOMT120424R	Multi-Purpose - 0.093" R			●		●			
AOMT120430FR	Multi-Purpose - 3.000 mm R			●					
AOMT120432R	Multi-Purpose - 0.125" R	●		●	●	●	●		
AOMT120440R*	Multi-Purpose - 4.000 mm R							●	

* Cutter body must be relieved to accept R 4.000mm ● = P ● = M ● = K ● = N ○ = S

HARDWARE	
 Screw	 Driver
SM35-076-10	DS-T10T

HI-POS⁺ SERIES 12V1X (TOP-ON STYLE)

BACK DRAFTED END MILL

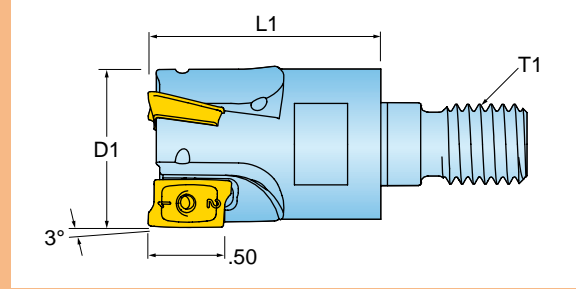

Cutter Number	D1 Nominal Diameter	T1 Adaption	L1 Extension Length	Number of Inserts	Wrench Size
12V1X-07015X6R01	0.750	M10	1.50	2	15mm
12V1X-10015X7R01	1.000	M12	1.50	2	17mm
12V1X-10015X7R02	1.000	M12	1.50	3	17mm
12V1X-12017X8R01	1.500	M16	1.75	4	22mm

For Top-On shanks and adaptors, see [pages 730-737](#).
Operating guidelines on [346](#).



INSERTS

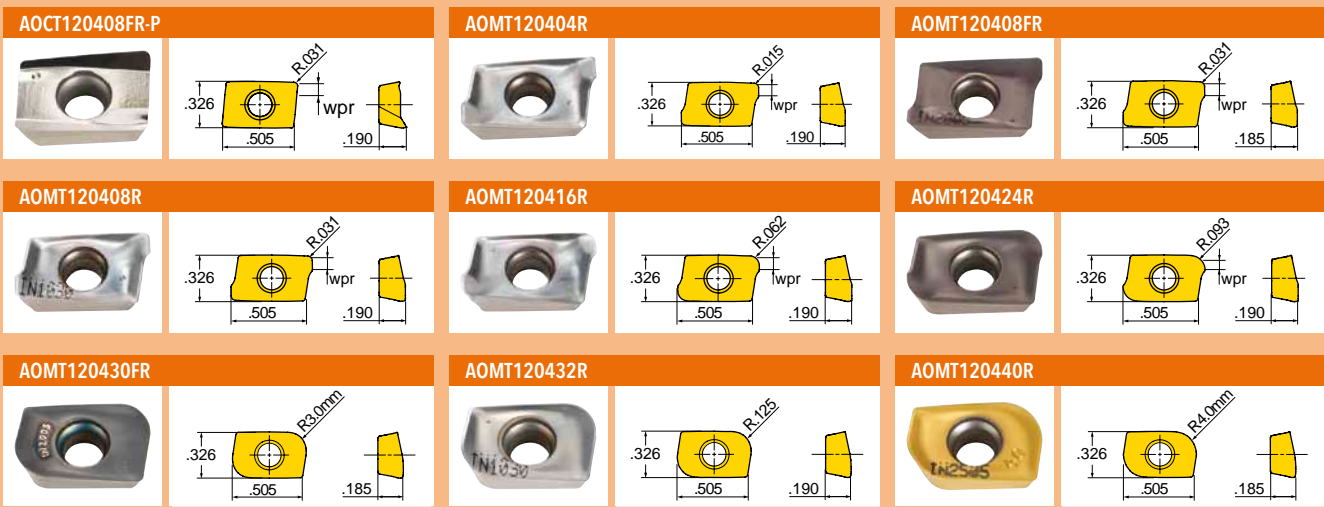

Part Number	Applications	Grade	IN1030	IN10K	IN2005	IN2010	IN2030	IN2040	IN2505	IN2510
			AOCT120408FR-P	Grd/Pol for Al - 0.031" R			●			
AOMT120404R	Multi-Purpose - 0.015" R		●		●					
AOMT120408FR	Hi-Temp/Ti - 0.031" R				●		●			
AOMT120408R	Multi-Purpose - 0.031" R		●		●	●	●	●	●	
AOMT120416R	Multi-Purpose - 0.062" R		●		●		●			●
AOMT120424R	Multi-Purpose - 0.093" R				●		●			
AOMT120430FR	Multi-Purpose - 3.000 mm R				●					
AOMT120432R	Multi-Purpose - 0.125" R		●		●	●	●	●		
AOMT120440R*	Multi-Purpose - 4.000 mm R								●	

* Cutter body must be relieved to accept R 4.000mm

● = P ● = M ● = K ● = N ○ = S

HARDWARE



Screw Driver

SM35-076-10 DS-T15T

HI-POS+™ SERIES 12J1R

0 DEGREE LEAD END MILL

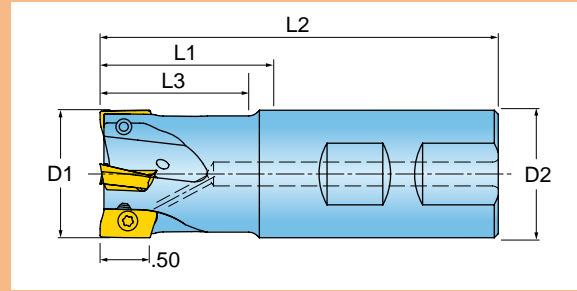

Cutter Number	D1 Nom. Dia.	L1 Extension Length	L2 Projection Length	L3 Overall Length	D2 Shank Size/Style	Number of Inserts	Ramp Angle
12J1R-0702084R01	0.750	2.00	1.75	4.00	.750" Cylindrical	1	8
12J1R-1001780R01	1.000	1.75	1.72	4.00	1.000" Cylindrical	3	7.9
12J1R-1003780R01	1.000	3.75	3.72	6.00	1.000" Cylindrical	3	7.9
12J1R-1202281R01	1.250	2.25	2.22	4.50	1.250" Weldon	4	5
12J1R-1502281R01	1.500	2.25	2.25	4.50	1.250" Weldon	4	3.5

Operating guidelines on [346](#).



INSERTS

BOCT130404FR-P 	BOMT130404R 	BOMT130408R
BOMT130416R 	BOMT130420R 	BOMT130424R
BOMT130431R 	BOMT130440R 	

Part Number	Applications	Grade	IN10K	IN2030	IN2505						
BOCT130404FR-P	Grd/Pol for Al - 0.015" R		●								
BOMT130404R	Multi-Purpose - 0.015" R			●	●						
BOMT130408R	Multi-Purpose - 0.031" R			●	●						
BOMT130416R	Multi-Purpose - 0.062" R			●	●						
BOMT130420R	Multi-Purpose - 0.078" R			●	●						
BOMT130424R	Multi-Purpose - 0.093" R			●	●						
BOMT130431R	Multi-Purpose - 0.125" R			●	●						
BOMT130440R*	Multi-Purpose - 0.156" R			●	●						

* Cutter body must be relieved to accept R. 156

● = P ● = M ● = K ● = N ○ = S

HARDWARE		
	Screw	Driver
	SM35-088-10	DS-T15T

0 DEGREE LEAD END MILL

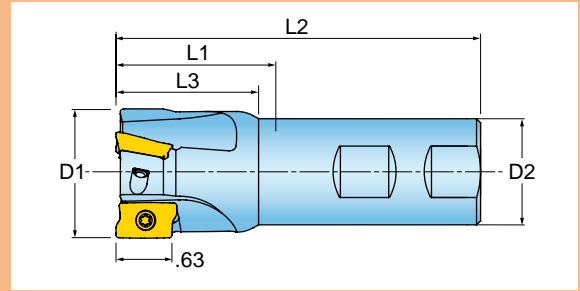

Cutter Number	D1 Nom. Dia.	L1 Extension Length	L3 Projection Length	L2 Overall Length	D2 Shank Size/Style	Number of Inserts	Ramp Angle	Coolant Thru
12J1G-0701284R01	0.750	1.75	1.25	3.75	.750" Weldon	1	11	No
12J1G-1001580R01	1.000	1.75	1.50	4.00	1.000" Weldon	2	5.8	No
12J1G-1001580R02	1.000	1.75	1.50	4.00	1.000" Weldon	2	5.8	Yes
12J1G-1003780R01	1.000	3.75	3.50	6.00	1.000" Weldon	2	5.8	No
12J1G-1006080R01	1.000	6.00	5.75	8.00	1.000" Weldon	2	Not Recomm.	No
12J1G-1008080R01	1.000	8.00	7.75	10.00	1.000" Weldon	2	Not Recomm.	No
12J1G-1201681R01	1.250	2.25	1.60	4.50	1.250" Weldon	3	3.5	No
12J1G-1201681R02	1.250	2.25	1.60	4.50	1.250" Weldon	3	3.5	Yes
12J1G-1204281R01	1.250	4.25	3.75	6.50	1.250" Weldon	3	3.5	No
12J1G-1205281R01	1.250	5.75	5.25	8.00	1.250" Weldon	3	Not Recomm.	No
12J1G-1207281R01	1.250	7.75	7.25	10.00	1.250" Weldon	3	Not Recomm.	No
12J1G-1501681R03	1.500	2.25	2.25	4.50	1.250" Weldon	4	2.3	Yes
12J1G-1501681R04	1.500	2.25	2.25	4.50	1.250" Weldon	3	2.3	Yes
12J1G-1501681R01	1.500	2.25	2.25	4.50	1.250" Weldon	4	2.3	No
12J1G-1501681R02	1.500	2.25	2.25	4.50	1.250" Weldon	3	2.3	No
12J1G-1501881R01	1.500	4.25	4.25	6.50	1.250" Weldon	3	2.3	No
12J1G-1505586R01	1.500	5.50	5.50	8.00	1.500" Weldon	3	Not Recomm.	No
12J1G-1501881R02	1.500	5.75	5.75	8.00	1.250" Weldon	3	Not Recomm.	No
12J1G-1507586R01	1.500	7.50	7.50	10.00	1.500" Weldon	3	Not Recomm.	No
12J1G-1701781R01	1.750	2.25	2.25	4.50	1.250" Weldon	4	1.8	No
12J1G-2001781R01	2.000	2.25	2.25	4.50	1.250" Weldon	5	1.6	No

Relieve cutter body for insert radii larger than 0.125" R
 Operating guidelines on [346](#).



INSERTS

AOCT170508FR-P 	AOMT170504R 	AOMT170508R
AOMT170508R-HS 	AOMT170516R 	AOMT170524R
AOMT170532R 	AOMT170540R-EM 	AOMT170548R
AOMT170564R 		

Part Number	Applications	Grade	IN1030	IN2005	IN2010	IN2030	IN2040	IN2505	IN2510	INDD15	IN10K
AOCT170508FR-P	Grd/Pol for Al - 0.031" R										●
AOMT170504R	Multi-Purpose - 0.015" R		●				●				
AOMT170508R	Multi-Purpose - 0.031" R		●	●		●	●	●	●	●	
AOMT170508R-HS	Hi-Temp/Ti - 0.031" R		●	●	●	●					
AOMT170516R	Multi-Purpose - 0.062" R		●	●	●	●					
AOMT170524R	Multi-Purpose - 0.093" R		●	●	●						
AOMT170532R	Multi-Purpose - 0.125" R		●	●			●				
AOMT170540R-EM*	Multi-Purpose - 0.156" R		●	●			●				
AOMT170548R*	Multi-Purpose - 0.187" R		●	●			●				
AOMT170564R*	Multi-Purpose - 0.250" R		●	●						●	

* Cutter body must be relieved to accept radii ● = P ● = M ● = K ● = N ○ = S

HARDWARE



.750 - 1.00	SM40-084-20	DS-T15T
1.125 - 2.00	SM40-093-10	DS-T15T

HIOPOS⁺ SERIES 12J1G (TOP-ON STYLE)

0 DEGREE LEAD END MILL

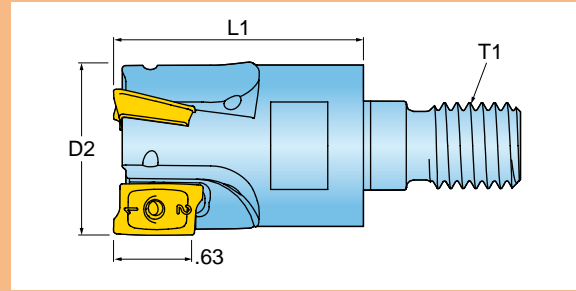

Cutter Number	D1 Nominal Diameter	T1 Adaption	L1 Extension Length	Number of Inserts	Wrench Size
12J1G-10015X7R01	1.000	M12	1.50	2	17mm
12J1G-12017X8R01	1.250	M16	1.75	3	22mm

For Top-On shanks and adaptors, see [pages 730-737](#).
Operating guidelines on [346](#).



INSERTS

AOCT170508FR-P 	AOMT170504R 	AOMT170508R
AOMT170508R-HS 	AOMT170516R 	AOMT170524R
AOMT170532R 	AOMT170540R-EM 	AOMT170548R
AOMT170564R 		

Part Number	Applications	Grade	IN1030	IN2005	IN2010	IN2030	IN2040	IN2505	IN2510	INDD15	IN10K
AOCT170508FR-P	Grd/Pol for Al - 0.031" R										●
AOMT170504R	Multi-Purpose - 0.015" R		●				●				
AOMT170508R	Multi-Purpose - 0.031" R		●	●		●	●	●	●	●	
AOMT170508R-HS	Hi-Temp/Ti - 0.031" R		●	●	●	●					
AOMT170516R	Multi-Purpose - 0.062" R		●	●	●	●					
AOMT170524R	Multi-Purpose - 0.093" R		●	●	●						
AOMT170532R	Multi-Purpose - 0.125" R		●	●			●				
AOMT170540R-EM*	Multi-Purpose - 0.156" R		●				●				
AOMT170548R*	Multi-Purpose - 0.187" R		●	●			●				
AOMT170564R*	Multi-Purpose - 0.250" R		●	●						●	

* Cutter body must be relieved to accept radii

● = P ● = M ● = K ● = N ○ = S

HARDWARE



.750 - 1.00	SM40-084-20	DS-T15T
1.125 - 2.00	SM40-093-10	DS-T15T

0 DEGREE LEAD END MILL

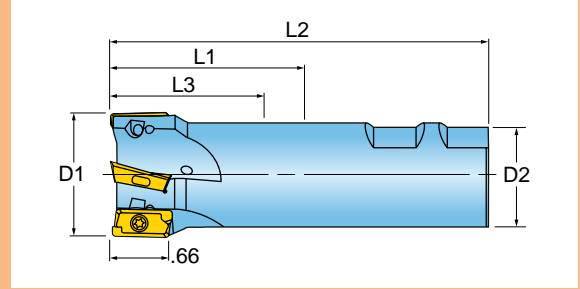

Cutter Number	D1 Nominal Diameter	L1 Extension Length	L2 Overall Length	L3 Projection Length	D2 Shank Size/Style	Number of Inserts	Ramp Angle
12J1E-0901780R01	0.970	1.75	4.00	1.50	1.000" Weldon	2	6.2
12J1E-1001780R01	1.000	1.75	4.00	1.50	1.000" Weldon	2	6.0
12J1E-1002780R01	1.000	2.75	5.00	2.50	1.000" Weldon	2	6.0
12J1E-1003780R01	1.000	3.75	6.00	3.50	1.000" Weldon	2	6.0
12J1E-1004029R01	1.000	4.00	6.69	2.50	#40 V-Flange	2	6.0
12J1E-1005780R01	1.000	5.75	8.00	5.72	1.000" Weldon	2	Not Recommended
12J4E-1001780R01**	1.000	1.75	4.00	1.50	1.000" Weldon	2	4.0
12J4E-1002780R01**	1.000	2.75	5.00	2.50	1.000" Weldon	2	4.0
12J1E-1202281R01	1.250	2.25	4.50	1.50	1.250" Weldon	3	4.1
12J1E-1202829R01	1.250	2.87	5.56	2.00	#40 V-Flange	3	4.1
12J1E-1204281R01	1.250	4.25	6.50	4.25	1.250" Weldon	3	4.1
12J1E-1206281R01	1.250	6.25	8.50	6.22	1.250" Weldon	2	Not Recommended
12J4E-1202281R01**	1.250	2.25	4.50	1.50	1.250" Weldon	3	3.0
12J4E-1204281R01**	1.250	4.25	6.50	3.50	1.250" Weldon	3	Not Recommended
12J1E-1502281R01	1.500	2.25	4.50	2.25	1.250" Weldon	4	3.0
12J1E-1502281R03	1.500	2.25	4.50	2.25	1.250" Weldon	3	3.0
12J1E-1502829R01	1.500	2.87	5.56	2.00	#40 V-Flange	3	3.0
12J1E-1504281R01	1.500	4.25	6.50	4.25	1.250" Weldon	3	3.0
12J4E-1502281R01**	1.500	2.25	4.50	2.25	1.250" Weldon	3	2.0
12J1E-2002281R01	2.000	2.25	4.50	2.25	1.250" Weldon	5	3.0
12J4E-2002281R01**	2.000	2.25	4.50	2.25	1.250" Weldon	5	2.0

** Cutters utilize large radius inserts > .125" R Operating guidelines on 352.

Part Number	Applications	Grade	IN05S	IN1030	IN2005	IN2015	IN2030	IN2040	IN30M		
AOMT180504FR-P	Grd/Pol for Al - 0.015" R		●								
AOMT180504R-HS	Hi-Temp/Ti - 0.015" R						●				
AOMT180508FR-P	Grd/Pol for Al - 0.031" R								●		
AOMT180508R	Multi-Purpose - 0.031" R		●	●	●	●	●	●			
AOMT180508R-HS	Hi-Temp/Ti - 0.031" R			●	●	●	●		●		
AOMT180516FR-P	Grd/Pol for Al - 0.062" R								●		
AOMT180516R	Multi-Purpose - 0.062" R		●	●	●	●	●	●			
AOMT180516R-HS	Hi-Temp/Ti - 0.062" R			●					●		
AOMT180524FR-P	Grd/Pol for Al - 0.093" R								●		
AOMT180524R	Multi-Purpose - 0.093" R		●	●				●			
AOMT180532FR-P	Grd/Pol for Al - 0.125" R								●		
AOMT180532R	Multi-Purpose - 0.125" R		●	●	●	●	●	●			
AOMT180548R*	Multi-Purpose - 0.187" R			●							
AOMT180564R*	Multi-Purpose - 0.250" R		●	●				●			

* Use in 12J4E bodies

● = P ○ = M ● = K ● = N ○ = S



INSERTS

AOMT180504FR-P		AOMT180504R-HS		AOMT180508FR-P	
AOMT180508R		AOMT180508R-HS		AOMT180516FR-P	
AOMT180516R		AOMT180516R-HS		AOMT180524FR-P	
AOMT180524R		AOMT180532FR-P		AOMT180532R	
AOMT180548R		AOMT180564R			

HARDWARE



Screw

Driver

12J1E-0901780R01	SM40-084-20	DS-T15T
12J1E-1001780R01	SM40-084-20	DS-T15T
12J1E-1002780R01	SM40-084-20	DS-T15T
12J1E-1003780R01	SM40-084-20	DS-T15T
12J1E-1004029R01	SM40-084-20	DS-T15T
12J1E-1005780R01	SM40-080-30	DS-T15T
12J4E-1001780R01	SM40-084-20	DS-T15T
12J4E-1002780R01	SM40-084-20	DS-T15T
12J1E-1202281R01	SM40-093-20	DS-T15T
12J1E-1202829R01	SM40-093-20	DS-T15T
12J1E-1204281R01	SM40-093-20	DS-T15T
12J1E-1206281R01	SM40-093-20	DS-T15T
12J4E-1202281R01	SM40-093-20	DS-T15T
12J4E-1204281R01	SM40-093-20	DS-T15T
12J1E-1502281R01	SM40-093-20	DS-T15T
12J1E-1502281R03	SM40-093-20	DS-T15T
12J1E-1502829R01	SM40-093-20	DS-T15T
12J1E-1504281R01	SM40-093-20	DS-T15T
12J4E-1502281R01	SM40-093-20	DS-T15T
12J1E-2002281R01	SM40-093-20	DS-T15T
12J4E-2002281R01	SM40-093-20	DS-T15T

HIPOST[™] SERIES 12J1E (TOP-ON STYLE)

0 DEGREE LEAD END MILL

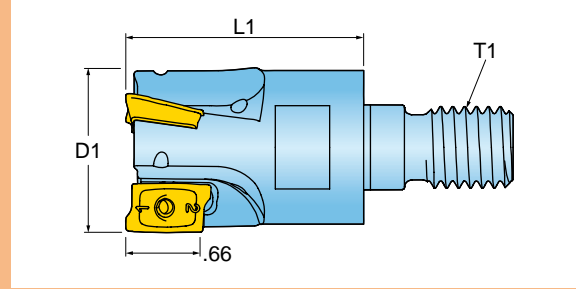

Cutter Number	D1 Nominal Diameter	T1 Adaption	L1 Extension Length	Number of Inserts	Wrench Size
12J1E-10015X7R01	1.000	M12	1.50	2	17mm
12J1E-12017X8R01	1.250	M12	1.75	3	22mm

For Top-On shanks and adaptors, see [pages 730-737](#).
Operating guidelines on [352](#).



INSERTS

AOMT180504FR-P		AOMT180504R-HS		AOMT180508FR-P	
AOMT180508R		AOMT180508R-HS		AOMT180516FR-P	
AOMT180516R		AOMT180516R-HS		AOMT180524FR-P	
AOMT180524R		AOMT180532FR-P		AOMT180532R	
AOMT180548R		AOMT180564R			

Part Number	Applications	Grade	Applications						
			IN05S	IN1030	IN2005	IN2015	IN2030	IN2040	IN30M

AOMT180504FR-P	Grd/Pol for Al - 0.015" R		●								
AOMT180504R-HS	Hi-Temp/Ti - 0.015" R						●				
AOMT180508FR-P	Grd/Pol for Al - 0.031" R										●
AOMT180508R	Multi-Purpose - 0.031" R		●	●	●	●	●	●			
AOMT180508R-HS	Hi-Temp/Ti - 0.031" R			●		●					●
AOMT180516FR-P	Grd/Pol for Al - 0.062" R										●
AOMT180516R	Multi-Purpose - 0.062" R		●	●	●	●	●	●			
AOMT180516R-HS	Hi-Temp/Ti - 0.062" R			●							●
AOMT180524FR-P	Grd/Pol for Al - 0.093" R										●
AOMT180524R	Multi-Purpose - 0.093" R		●	●				●			
AOMT180532FR-P	Grd/Pol for Al - 0.125" R										●
AOMT180532R	Multi-Purpose - 0.125" R		●	●	●	●	●	●			

● = P ● = M ● = K ● = N ○ = S

HARDWARE



Screw

Driver

12J1E-10015X7R01	SM40-084-20	DS-T15T
12J1E-12017X8R01	SM40-093-20	DS-T15T

TETRA™ SERIES 1TJ1N

0 DEGREE LEAD END MILL WITH 4 INDEXES

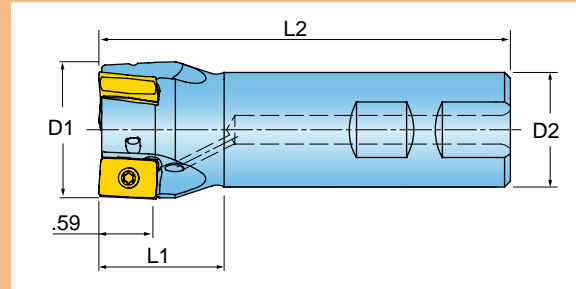

Cutter Number	D1 Nominal Diameter	L1 Extension Length	L2 Overall Length	D2 Shank Size/Style	Number of Inserts	Ramp Angle
1TJ1N-1202281R01	1.250	2.25	4.50	1.250" Weldon	2	1.2
1TJ1N-1204281R01	1.250	4.25	6.50	1.250" Weldon	2	1.2
1TJ1N-1206281R01	1.250	6.25	8.50	1.250" Weldon	2	1.2
1TJ1N-1502281R01	1.500	2.25	4.50	1.250" Weldon	3	1.1
1TJ1N-1504281R01	1.500	4.25	6.50	1.250" Weldon	3	1.1
1TJ1N-2002281R01	2.000	2.25	4.50	1.250" Weldon	4	1.0

Operating guidelines on 353.

INSERTS

ANHU160704FR-P 	ANHU160704R 	ANHU160708FR
ANHU160708FR-P 	ANHU160708R 	ANHU160716R

Part Number	Applications	Grade	IN10K	IN2010	IN2030	IN2505	IN2540	INDD15			
ANHU160704FR-P	Grd/Pol for Al - 0.015" R		●								
ANHU160704R	Multi-Purpose - 0.015" R				●						
ANHU160708FR	Hi-Temp/Ti - 0.031" R				●						
ANHU160708FR-P	Grd/Pol for Al - 0.031" R		●								
ANHU160708R	Multi-Purpose - 0.031" R			●	●	●	●	●			
ANHU160716R	Multi-Purpose - 0.062" R			●	●	●	●				

● = P ● = M ● = K ● = N ○ = S

HARDWARE		
	Screw	Driver
	SM40-120-20	DS-T15T

TETRA™ SERIES 1TJ1N (TOP-ON STYLE)

0 DEGREE LEAD END MILL WITH 4 INDEXES

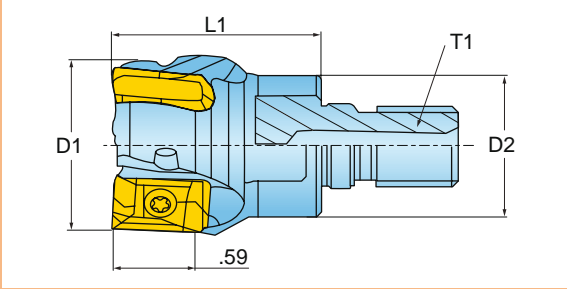

Cutter Number	D1 Nom. Dia.	T1 Adaption	L1 Extension Length	Number of Inserts	Wrench Size	Ramp Angle
1TJ1N-12015X8R01	1.250	M16	1.50	2	22mm	1.2
1TJ1N-15015X8R01	1.500	M16	1.50	3	22mm	1.1

For Top-On shanks and adaptors, see pages 730-737.
Operating guidelines on 353.

INSERTS

ANHU160704FR-P 	ANHU160704R 	ANHU160708FR
ANHU160708FR-P 	ANHU160708R 	ANHU160716R

Part Number	Applications	Grade	IN10K	IN2010	IN2030	IN2505	IN2540	INDD15			
ANHU160704FR-P	Grd/Pol for Al - 0.015" R		●								
ANHU160704R	Multi-Purpose - 0.015" R				●						
ANHU160708FR	Hi-Temp/Ti - 0.031" R				●						
ANHU160708FR-P	Grd/Pol for Al - 0.031" R		●								
ANHU160708R	Multi-Purpose - 0.031" R			●	●	●	●	●			
ANHU160716R	Multi-Purpose - 0.062" R			●	●	●	●				

● = P ● = M ● = K ● = N ○ = S

HARDWARE



SM40-120-20 DS-T15T

0 DEGREE LEAD END MILL WITH 4 INDEXES

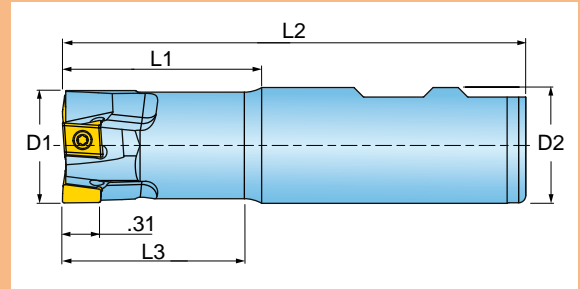

Cutter Number	D1 Eff. Dia.	Number of Inserts	Number of Effective Inserts	L1 Extension Length	L2 Overall Length	L3 Projection Length	D2 Shank Size/Style
1SJ1Y-0701284R01	0.750	2	2	1.25	3.25	1.06	.750" Weldon
1SJ1Y-0701280R01	0.750	2	2	1.25	3.50	0.95	1.000" Weldon
1SJ1Y-0701280R02	0.750	3	3	1.25	3.50	0.95	1.000" Weldon
1SJ1Y-0702280R01	0.750	2	2	2.25	4.50	1.95	1.000" Weldon
1SJ1Y-0703280R01	0.750	2	2	3.25	5.50	2.95	1.000" Weldon
1SJ1Y-1001784R01	1.000	3	3	1.75	3.75	1.75	.750" Weldon
1SJ1Y-1001780R01	1.000	3	3	1.75	4.00	1.56	1.000" Weldon
1SJ1Y-1001780R02	1.000	4	4	1.75	4.00	1.56	1.000" Weldon
1SJ1Y-1003280R01	1.000	3	3	3.25	5.50	3.06	1.000" Weldon
1SJ1Y-1201784R01	1.250	3	3	1.75	3.75	1.75	.750" Weldon
1SJ1Y-1201781R01	1.250	3	3	1.75	4.00	1.56	1.250" Weldon
1SJ1Y-1201781R02	1.250	5	5	1.75	4.00	1.56	1.250" Weldon
1SJ1Y-1203281R01	1.250	4	4	3.25	5.50	3.06	1.250" Weldon
1SJ1Y-1501781R01	1.500	4	4	1.75	4.00	1.75	1.250" Weldon
1SJ1Y-1501781R02	1.500	6	6	1.75	4.00	1.75	1.250" Weldon
1SJ1Y-1502281R01	1.500	5	5	2.25	4.50	2.25	1.250" Weldon

Operating guidelines on [355](#).

INSERTS

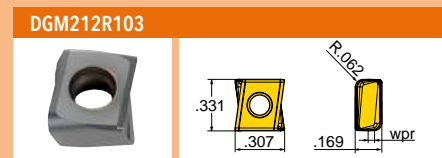
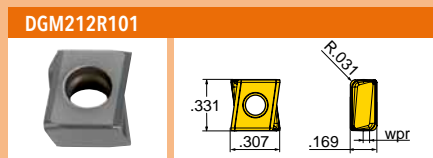
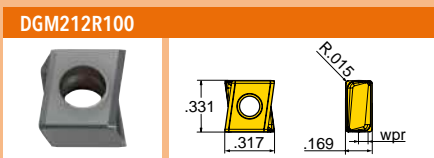

Part Number	Applications	Grade													
			IN2005	IN2015	IN2030										
DGM212R100	Multi-Purpose - 0.015" R														
DGM212R101	Multi-Purpose - 0.031" R														
DGM212R103	Multi-Purpose - 0.062" R														

● = P ● = M ● = K ● = N ○ = S

HARDWARE



	Insert Screw	Driver
1SJ1Y-0701284R01	SM30-074-21	DS-T08W
1SJ1Y-0701280R01	SM30-074-21	DS-T08W
1SJ1Y-0701280R02	SM30-074-21	DS-T08W
1SJ1Y-0702280R01	SM30-074-21	DS-T08W
1SJ1Y-0703280R01	SM30-074-21	DS-T08W
1SJ1Y-1001784R01	SM30-082-21	DS-T08W
1SJ1Y-1001780R01	SM30-082-21	DS-T08W
1SJ1Y-1001780R02	SM30-082-21	DS-T08W
1SJ1Y-1003280R01	SM30-082-21	DS-T08W
1SJ1Y-1201784R01	SM30-082-21	DS-T08W
1SJ1Y-1201781R01	SM30-082-21	DS-T08W
1SJ1Y-1201781R02	SM30-082-21	DS-T08W
1SJ1Y-1203281R01	SM30-082-21	DS-T08W
1SJ1Y-1501781R01	SM30-082-21	DS-T08W
1SJ1Y-1501781R02	SM30-082-21	DS-T08W
1SJ1Y-1502281R01	SM30-082-21	DS-T08W

0 DEGREE LEAD END MILL WITH 4 INDEXES

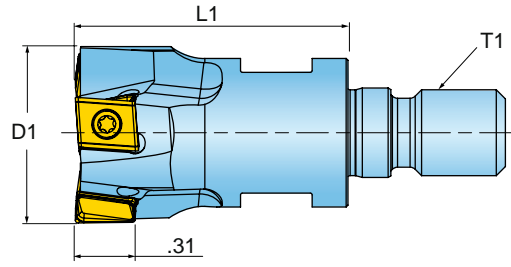

Cutter Number	D1 Nominal Diameter	T1 Adaption	L1 Extension Length	Number of Inserts	Wrench Size
1SJ1Y-07015X6R01	0.750	M10	1.50	2	15mm
1SJ1Y-07015X6R02	0.750	M10	1.50	3	15mm
1SJ1Y-10015X7R01	1.000	M12	1.50	3	17mm
1SJ1Y-10015X7R02	1.000	M12	1.50	4	17mm
1SJ1Y-12017X8R01	1.250	M16	1.75	3	22mm
1SJ1Y-12017X8R02	1.250	M16	1.75	5	22mm
1SJ1Y-15017X8R01	1.500	M16	1.75	4	22mm
1SJ1Y-15017X8R02	1.500	M16	1.75	6	22mm

For Top-On shanks and adaptors, see [pages 730-737](#).
Operating guidelines on [355](#).

INSERTS

DGM212R100

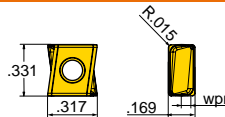

DGM212R101

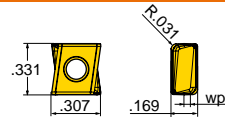

DGM212R103

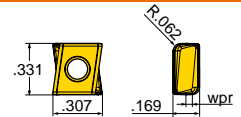

Part Number	Applications	Grade					
			IN2005	IN2015	IN2030		
DGM212R100	Multi-Purpose - 0.015" R						
DGM212R101	Multi-Purpose - 0.031" R						
DGM212R103	Multi-Purpose - 0.062" R						

● = P ● = M ● = K ● = N ○ = S

HARDWARE



Insert Screw

Driver

1SJ1Y-07015X6R01	SM30-074-21	DS-T08W
1SJ1Y-07015X6R02	SM30-074-21	DS-T08W
1SJ1Y-10015X7R01	SM30-082-21	DS-T08W
1SJ1Y-10015X7R02	SM30-082-21	DS-T08W
1SJ1Y-12017X8R01	SM30-082-21	DS-T08W
1SJ1Y-12017X8R02	SM30-082-21	DS-T08W
1SJ1Y-15017X8R01	SM30-082-21	DS-T08W
1SJ1Y-15017X8R02	SM30-082-21	DS-T08W

0 DEGREE LEAD END MILL WITH 4 INDEXES



Shoulder



Channel



Facing



Slabbing



Coolant

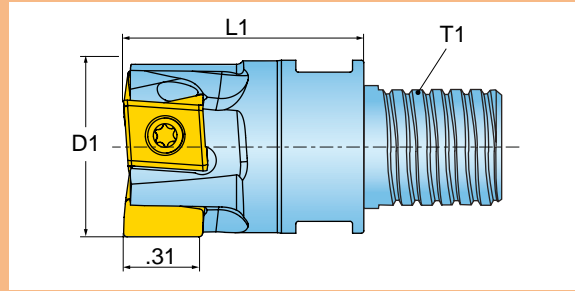

Cutter Number	D1 Nominal Diameter	T1 Adaption	L1 Extension Length	Number of Inserts
1SJ1Y-07010TSR01	0.750	T12	1.00	3
1SJ1Y-10012TUR01	1.000	T15	1.25	4

For Chip-Surfer shank selection, see [page 422](#).
Operating guidelines on [355](#).

INSERTS

DGM212R100

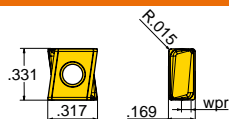

DGM212R101

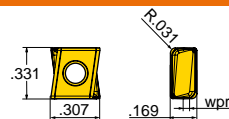

DGM212R103

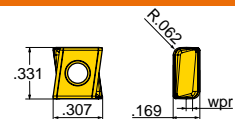

Part Number	Applications	Grade											
			IN2005	IN2015	IN2030								
DGM212R100	Multi-Purpose - 0.015" R												
DGM212R101	Multi-Purpose - 0.031" R												
DGM212R103	Multi-Purpose - 0.062" R												

● = P ● = M ● = K ● = N ○ = S

HARDWARE



Insert Screw



Driver



Wrench

1SJ1Y-07010TSR01	SM30-074-21	DS-T08W	WS-0059
1SJ1Y-10012TUR01	SM30-082-21	DS-T08W	WS-0061

0 DEGREE LEAD END MILL WITH 4 INDEXES

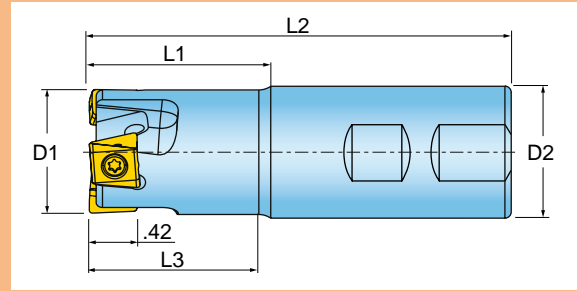

Cutter Number	D1 Eff. Dia.	L1 Extension Length	L2 Overall Length	L3 Projection Length	D2 Shank Size/Style	Number of Inserts
1SJ1F-1001780R01	1.000	1.75	4.00	1.59	1.000" Weldon	2
1SJ1F-1003780R01	1.000	3.75	6.00	3.59	1.000" Weldon	2
1SJ1F-1201781R01	1.250	1.75	4.00	1.59	1.250" Weldon	3
1SJ1F-1501781R01	1.500	1.75	4.00	1.75	1.250" Weldon	4
1SJ1F-1501781R02	1.500	1.75	4.00	1.75	1.250" Weldon	3

Operating guidelines on [356](#).



INSERTS

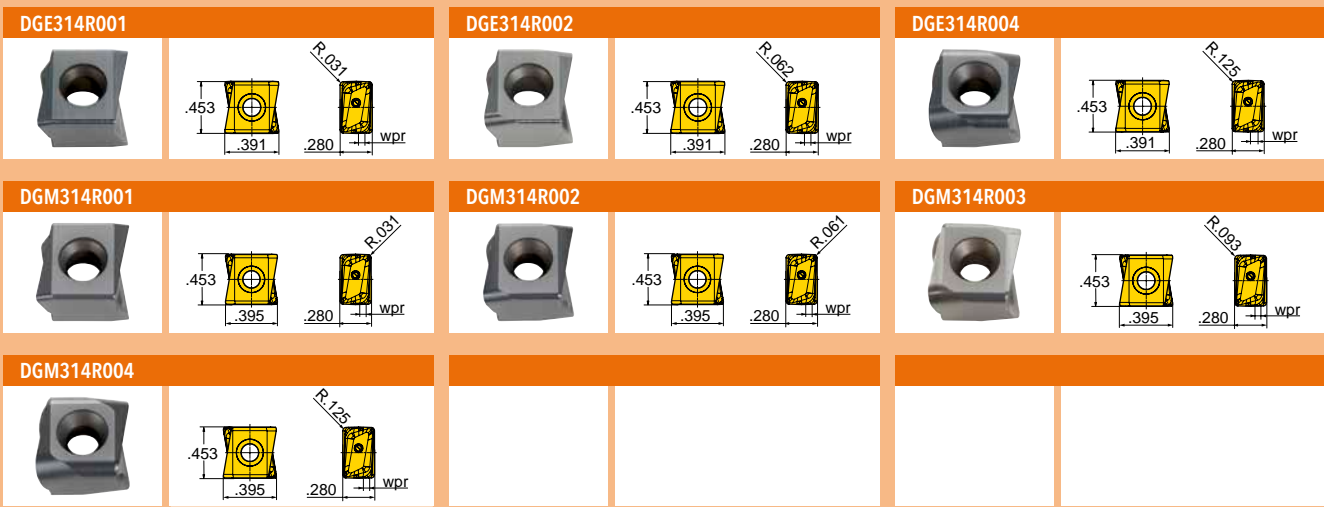

Part Number	Applications	Grade													
		IN2005	IN2015	IN2030	IN2040	IN6515									
DGE314R001	SS/Hi-Temp/Ti - 0.031" R			●											
DGE314R002	SS/Hi-Temp/Ti - 0.062" R			●											
DGE314R004	SS/Hi-Temp/Ti - 0.125" R			●											
DGM314R001	Multi-Purpose - 0.031" R	●	●	●	●	●									
DGM314R002	Multi-Purpose - 0.062" R	●	●	●	●	●									
DGM314R003	Multi-Purpose - 0.093" R	●													
DGM314R004	Multi-Purpose - 0.125" R	●	●	●	●	●									

● = P ● = M ● = K ● = N ○ = S

HARDWARE



Screw Driver

SM35-114-H0 DS-T15T

EVO•TEC™ SERIES 1SJ1F (TOP-ON STYLE)

0 DEGREE LEAD END MILL WITH 4 INDEXES

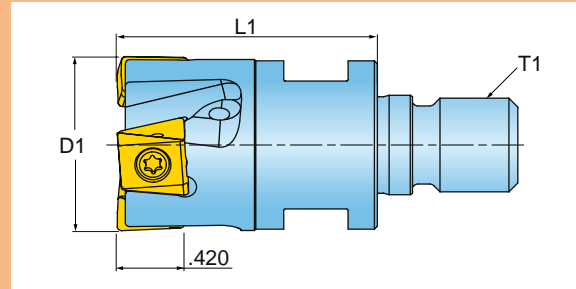

Cutter Number	D1 Eff. Dia.	L1 Extension Length	T1 Shank Size/Style	Number of Inserts
1SJ1F-10015X7R01	1.000	1.50	M12	2
1SJ1F-12015X8R01	1.250	1.75	M16	3
1SJ1F-12015X8R02	1.250	1.75	M16	2
1SJ1F-15015X8R01	1.500	1.75	M16	4
1SJ1F-15015X8R02	1.500	1.75	M16	3

For Top-On shanks and adaptors, see [pages 730-737](#).
Operating guidelines on [356](#).



INSERTS

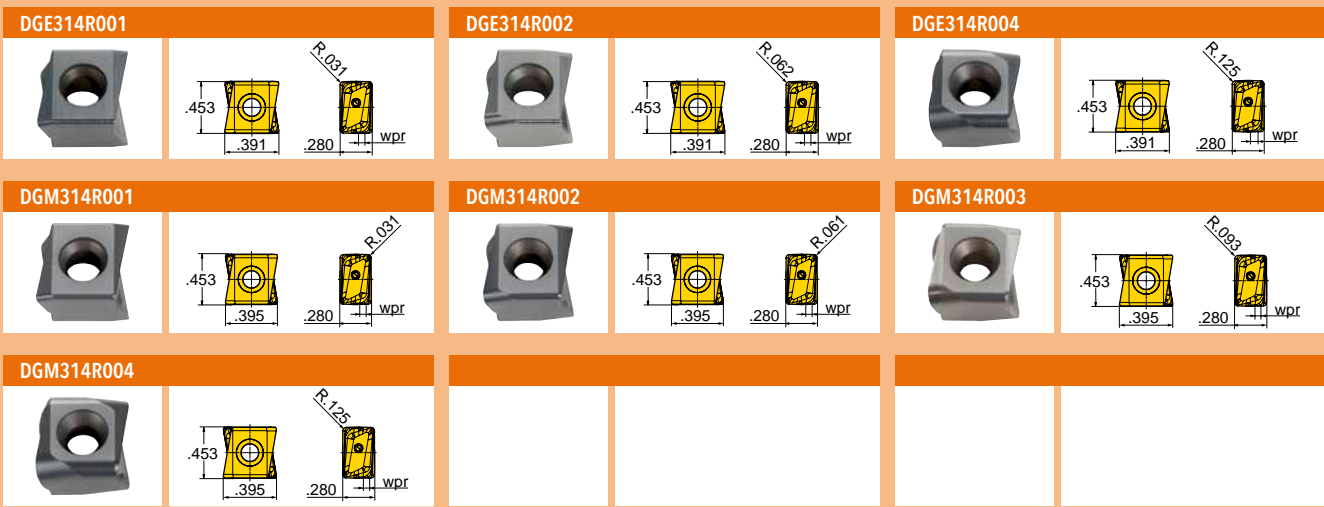

Part Number	Applications	Grade									
		IN2005	IN2015	IN2030	IN2040	IN6515					
DGE314R001	SS/Hi-Temp/Ti - 0.031" R			●							
DGE314R002	SS/Hi-Temp/Ti - 0.062" R			●							
DGE314R004	SS/Hi-Temp/Ti - 0.125" R			●							
DGM314R001	Multi-Purpose - 0.031" R	●	●	●	●	●					
DGM314R002	Multi-Purpose - 0.062" R	●	●	●	●	●					
DGM314R003	Multi-Purpose - 0.093" R	●									
DGM314R004	Multi-Purpose - 0.125" R	●	●	●	●	●					

● = P ● = M ● = K ● = N ○ = S

HARDWARE



Screw Driver

SM35-114-H0 DS-T15T

0 DEGREE LEAD END MILL

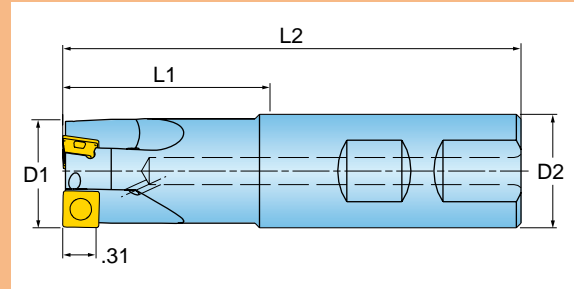

Cutter Number	D1 Nom. Dia.	L1 Extension Length	L2 Overall Length	D2 Shank Size/Style	Number of Inserts	Ramp Angle
15J1E-0601584R01	0.625	1.50	3.50	.750" Weldon	1	2.5
15J1E-0701784R01	0.750	1.75	3.75	.750" Weldon	2	2.5
15J1E-0703084R01	0.750	3.00	5.00	.750" Weldon	2	2.5
15J1E-1001780R01	1.000	1.75	4.00	1.000" Weldon	3	1.5
15J1E-1003580R01	1.000	3.50	5.75	1.000" Weldon	2	1.5
15J1E-1201780R01	1.250	1.75	4.00	1.000" Weldon	4	1

Operating guidelines on [353](#).



INSERTS

SDCT080305FN-P 	SDMT080305N 	SDMT080308N
SDMT080316N 	SDMW080305TN 	SDMW080305TN-W
SDMW080308TN 		

Part Number	Applications	Grade								
			IN1030	IN1530	IN2005	IN2015	IN2030	IN2040	IN30M	
SDCT080305FN-P	Grd/Pol for Al - 0.020" R									●
SDMT080305N	Multi-Purpose - 0.020" R		●		●	●	●	●	●	
SDMT080308N	Multi-Purpose - 0.031" R			●						
SDMT080316N	Multi-Purpose - 0.062" R			●						
SDMW080305TN	Heavy-Duty - 0.020" R		●		●	●	●			
SDMW080305TN-W*	Crowned Wiper - 0.020" R				●	●				
SDMW080308TN	Heavy-Duty - 0.031" R			●						

*When used, wiper inserts should be loaded in all stations. ● = P ● = M ● = K ● = N ○ = S

HARDWARE



Screw Driver

SM30-065-00 DS-T09W

ROUGH AIR™ SERIES 15X1W

0 DEGREE LEAD HIGH-SPEED ROUTER END MILL (ALUMINUM)

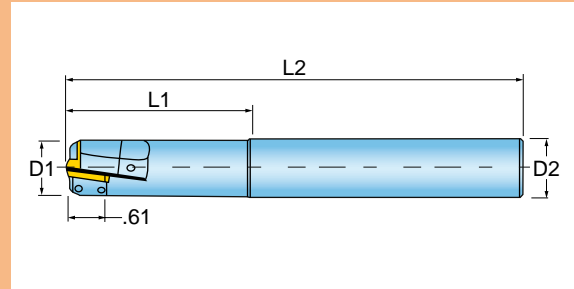

Cutter Number	D1 Nom. Dia.	L1 Extension Length	L2 Overall Length	D2 Shank Size/Style	Number of Inserts	Ramp Angle
15X1W-07020S1R01	0.750	2.20	5.00	.750" Cylindrical	1	4.6
15X1W-10020S1R01	1.000	2.20	4.50	1.000" Cylindrical	2	9.6
15X1W-12020S9R01	1.250	2.20	4.50	1.250" Cylindrical	3	12.0
15X1W-15040S5R01	1.500	4.06	6.75	1.500" Cylindrical	3	8.5

Prebalanced to: G6.3 @ 20,000 RPM
 Operating guidelines on [352](#).



INSERTS

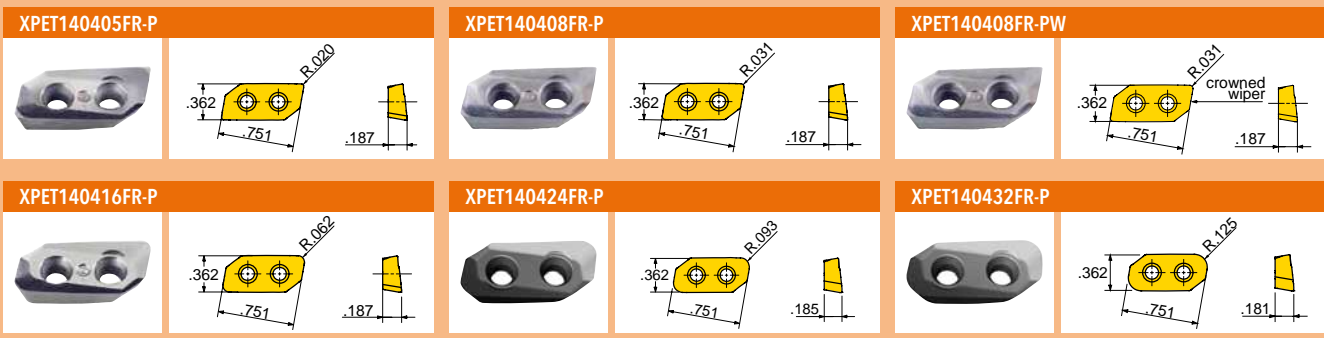

Part Number	Applications	Grade	IN15K							
XPET140405FR-P	Grd/Pol for Al - 0.020" R		●							
XPET140408FR-P	Grd/Pol for Al - 0.031" R		●							
XPET140408FR-PW	Grd/Pol for Al - 0.031" Wiper w/Radius		●							
XPET140416FR-P	Grd/Pol for Al - 0.062" R		●							
XPET140424FR-P	Grd/Pol for Al - 0.093" R		●							
XPET140432FR-P	Grd/Pol for Al - 0.125" R		●							

● = P ● = M ● = K ● = N ○ = S

HARDWARE



Screw

Driver

15X1W-07020S1R01	SM30-065-00	DS-T09W
15X1W-10020S1R01	SM30-065-00	DS-T09W
15X1W-12020S9R01	SM30-082-00	DS-T09W
15X1W-15040S5R01	SM30-082-00	DS-T09W

ROUGH AIR™ SERIES 15X1W (HSK ADAPTION)

0 DEGREE LEAD HIGH-SPEED ROUTER END MILL (ALUMINUM)

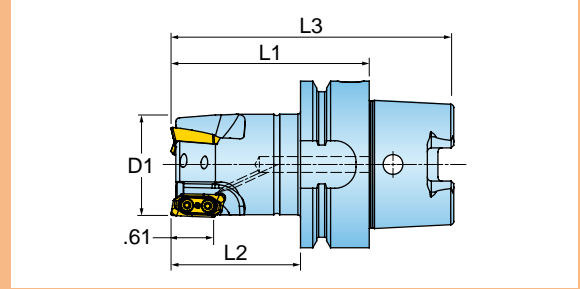

Cutter Number	D1 Nom. Dia.	L1 Extension Length	L2 Projection Length	L3 Overall Length	D2 Shank Size/Style	Number of Inserts	Ramp Angle
15X1W-15040H5R01	1.500	4.00	2.35	5.25	HSK-63-A	3	8.5
15X1W-15040H7R01	1.500	4.00	2.35	5.57	HSK-80-A	3	8.5
15X1W-20040H5R01	2.000	4.00	2.35	5.25	HSK-63-A	4	6.0
15X1W-20040H7R01	2.000	4.00	2.35	5.57	HSK-80-A	4	6.0
15X1W-20055H5R01	2.000	5.50	3.85	6.75	HSK-63-A	4	6.0
15X1W-30040H7R01	3.000	4.00	2.98	5.57	HSK-80-A	5	4.0
15X1W-30040H5R01	3.000	4.00	4.00	5.25	HSK-63-A	5	4.0
15X1W-30055H5R01	3.000	5.50	5.50	6.75	HSK-63-A	5	4.0

Prebalanced to: G2.5 @ 20,000 RPM
Operating guidelines on 352.

INSERTS

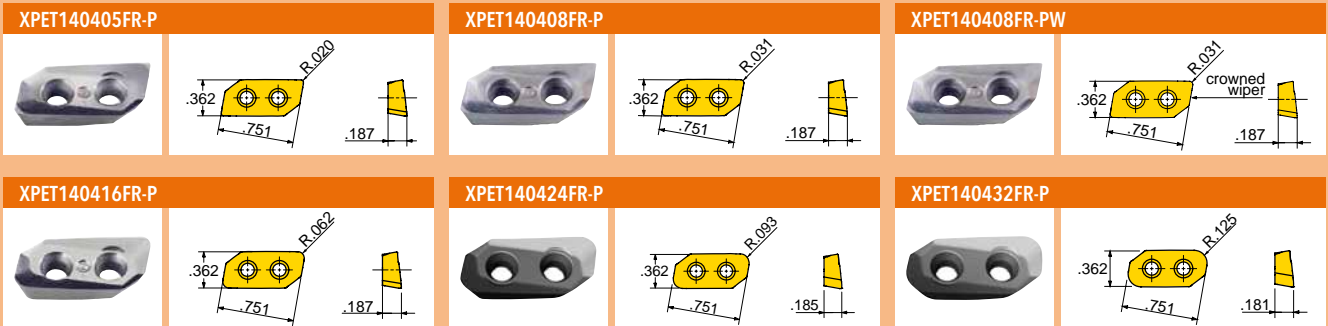

Part Number	Applications	Grade	IN15K							
XPET140405FR-P	Grd/Pol for Al - 0.020" R		●							
XPET140408FR-P	Grd/Pol for Al - 0.031" R		●							
XPET140408FR-PW	Grd/Pol for Al - 0.031" Wiper w/Radius		●							
XPET140416FR-P	Grd/Pol for Al - 0.062" R		●							
XPET140424FR-P	Grd/Pol for Al - 0.093" R		●							
XPET140432FR-P	Grd/Pol for Al - 0.125" R		●							

● = P ● = M ● = K ● = N ○ = S

HARDWARE



Screw

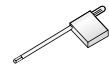

Driver

SM30-082-00

DS-T09W

ROUGH-AIR™ SERIES 15X1W (TOP-ON STYLE)

0 DEGREE LEAD HIGH-SPEED ROUTER END MILL (ALUMINUM)

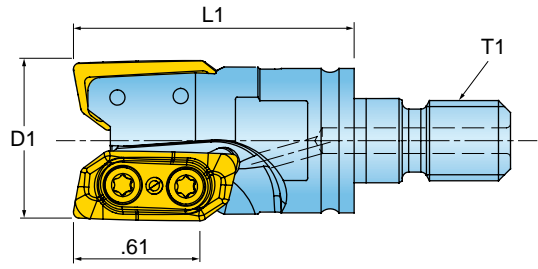

Cutter Number	D1 Nom. Dia.	T1 Adaption	L1 Extension Length	Number of Inserts	Wrench Size	Ramp Angle
15X1W-07013X6R01	0.750	M10	1.38	1	15mm	4.6
15X1W-10017X7R01	1.000	M12	1.75	2	17mm	9.6
15X1W-12017X8R01	1.250	M16	1.75	3	22mm	12
15X1W-15017X8R01	1.500	M16	1.75	3	22mm	8.5

For Top-On shanks and adaptors, see [pages 730-737](#).
Operating guidelines on [352](#).

INSERTS

XPET140405FR-P

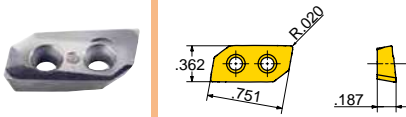

XPET140408FR-P

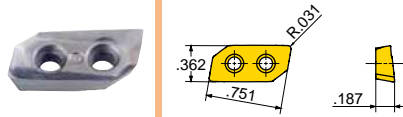

XPET140408FR-PW

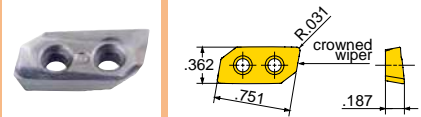

XPET140416FR-P

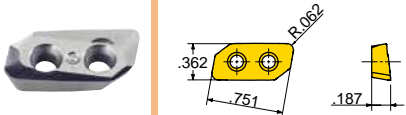

XPET140424FR-P

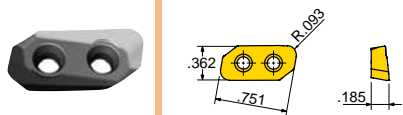

XPET140432FR-P

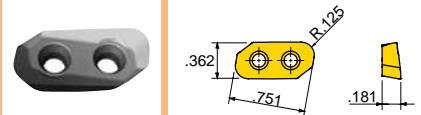

Part Number	Applications	Grade	IN15K						
XPET140405FR-P	Grd/Pol for Al - 0.020" R		●						
XPET140408FR-P	Grd/Pol for Al - 0.031" R		●						
XPET140408FR-PW	Grd/Pol for Al - 0.031" Wiper w/Radius		●						
XPET140416FR-P	Grd/Pol for Al - 0.062" R		●						
XPET140424FR-P	Grd/Pol for Al - 0.093" R		●						
XPET140432FR-P	Grd/Pol for Al - 0.125" R		●						

● = P ● = M ● = K ● = N ○ = S

HARDWARE



Screw



Driver

15X1W-07013X6R01	SM30-065-00	DS-T09W
15X1W-10017X7R01	SM30-065-00	DS-T09W
15X1W-12017X8R01	SM30-082-00	DS-T09W
15X1W-15017X8R01	SM30-082-00	DS-T09W

ROUGH AIR™ SERIES 15X1X

0 DEGREE LEAD HIGH-SPEED ROUTER END MILL (ALUMINUM)

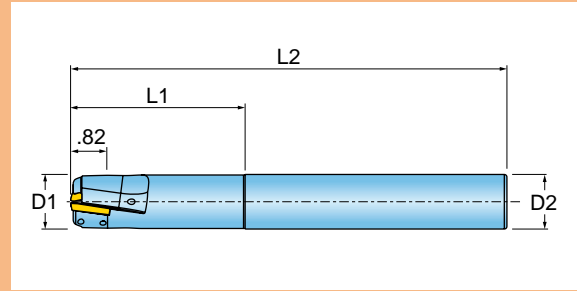

Cutter Number	D1 Nom. Dia.	L1 Extension Length	L2 Overall Length	D2 Shank Size/Style	Number of Inserts	Ramp Angle
15X1X-10020S1R01**	1.000	2.00	8.00	1.000" Cylindrical	2	21.0 (XR-P)
15X1X-12020S9R01	1.250	2.00	8.00	1.250" Cylindrical	2	20.8
15X1X-15040S9R02	1.500	4.00	10.00	1.250" Cylindrical	3	14.2
15X1X-15040S5R01	1.500	4.00	10.00	1.500" Cylindrical	2	14.2
15X1X-20040S2R01	2.000	4.00	10.00	2.000" Cylindrical	3	8.7

** Accepts XEET25040XR-P Insert Only
Operating guidelines on 352.

INSERTS

XEET250408R-P 	XEET250408R-PWRWK 	XEET25040XR-P
XEET250416R-P 	XEET250424R-P 	XEET250432R-P

Part Number	Applications	Grade	IN15K							
XEET250408R-P	Grd/Pol for Al - 0.031" R		●							
XEET250408R-PWRWK	Wiper - 0.031" R		●							
XEET25040XR-P**	Grd/Pol for Al - 0.031" R		●							
XEET250416R-P	Grd/Pol for Al - 0.062" R		●							
XEET250424R-P	Grd/Pol for Al - 0.093" R		●							
XEET250432R-P	Grd/Pol for Al - 0.125" R		●							

** 1.00" Diameter Tool Only

● = P ● = M ● = K ● = N ○ = S

HARDWARE



Screw

Driver

SM40-070-00

DS-T15T

ROUGH AIR™ SERIES 15X1X (TOP-ON STYLE)

0 DEGREE LEAD HIGH-SPEED ROUTER END MILL (ALUMINUM)



Shoulder



Channel



Ramping



Corkscrew



Pocket



Facing



Coolant

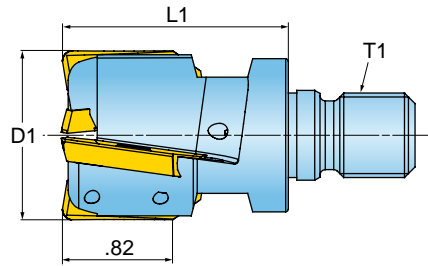

Cutter Number	D1 Nom. Dia.	T1 Adaption	L1 Extension Length	Number of Inserts	Wrench Size	Ramp Angle
15X1X-12017X8R01	1.250	M16	1.75	2	22mm	20.8
15X1X-15018X8R01	1.500	M16	1.88	2	22mm	14.2

For Top-On shanks and adaptors, see [pages 730-737](#).
Operating guidelines on [352](#).

INSERTS

XEET250408R-P

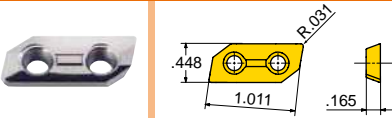

XEET250408R-PWRWK

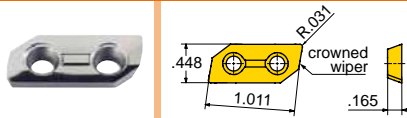

XEET250416R-P

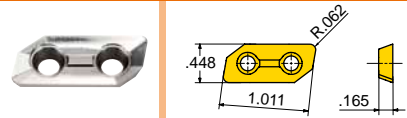

XEET250424R-P

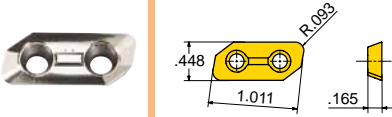

XEET250432R-P

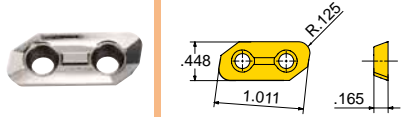

Part Number	Applications	Grade	IN15K									
XEET250408R-P	Grd/Pol for Al - 0.031" R		●									
XEET250408R-PWRWK	Wiper - 0.031" R		●									
XEET250416R-P	Grd/Pol for Al - 0.062" R		●									
XEET250424R-P	Grd/Pol for Al - 0.093" R		●									
XEET250432R-P	Grd/Pol for Al - 0.125" R		●									

● = P ● = M ● = K ● = N ○ = S

HARDWARE



Screw



Driver

SM40-070-00

DS-T15T

ROUGH-AIR™ SERIES 15X1Z

0 DEGREE LEAD HIGH-SPEED ROUTER END MILL (ALUMINUM)

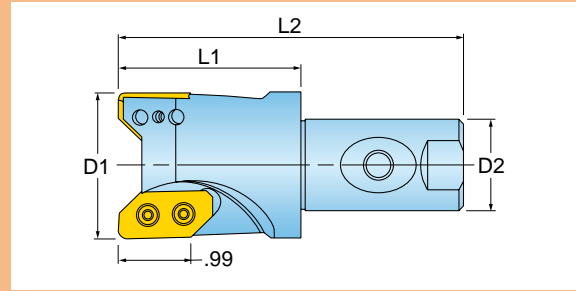

Cutter Number	D1 Nom. Dia.	L1 Extension Length	L2 Overall Length	D2 Shank Size/Style	Number of Inserts	Ramp Angle
15X1Z-2002581R01	2.000	2.50	4.75	1.250" Weldon	2	15.0
15X1Z-2002581R02	2.000	2.50	4.75	1.250" Weldon	2	15.0
15X1Z-2005548R01	2.000	5.50	9.50	ICT #50 V-Flange	2	15.0
15X1Z-20060S2R01	2.000	6.00	9.75	2.000" Cylindrical	2	15.0

Operating guidelines on [352](#).



INSERTS

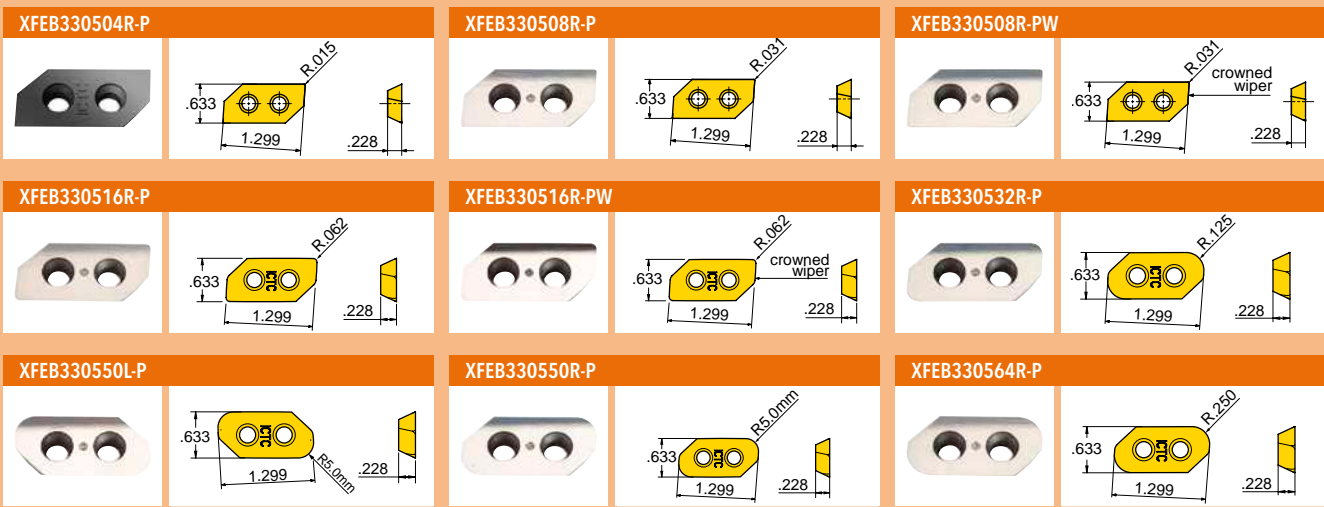

Part Number	Applications	Grade	IN15K										
XFEB330504R-P	Grd/Pol for Al - 0.020" (.5mm) R		●										
XFEB330508R-P	Grd/Pol for Al - 0.031" R		●										
XFEB330508R-PW	Wiper - 0.031" R		●										
XFEB330516R-P	Grd/Pol for Al - 0.062" R		●										
XFEB330516R-PW	Wiper - 0.062" R		●										
XFEB330532R-P	Grd/Pol for Al - 0.125" R		●										
XFEB330550L-P	Grd/Pol for Al - 0.197" (5mm) R		●										
XFEB330550R-P	Grd/Pol for Al - 0.197" (5mm) R		●										
XFEB330564R-P	Grd/Pol for Al - 0.250" R		●										

● = P ● = M ● = K ● = N ○ = S

HARDWARE



Screw Driver

SM50-100-10 DS-T20T

ALUMINATOR SERIES 15U1G

0 DEGREE LEAD HIGH-SPEED ROUTER END MILL (ALUMINUM)

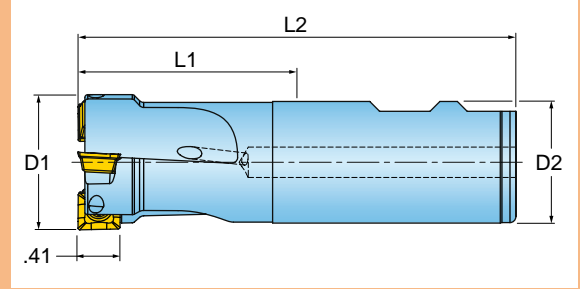

Cutter Number	D1 Nom. Dia.	L1 Extension Length	L2 Overall Length	D2 Shank Size/Style	Number of Inserts	Ramp Angle
15U1G-1001780R01	1.000	1.75	4.00	1.000" Weldon	2	2
15U1G-1202281R01	1.250	2.25	4.50	1.250" Weldon	3	6
15U1G-1502281R01	1.500	2.25	4.50	1.250" Weldon	3	4
15U1G-2002281R01	2.000	2.25	4.50	1.250" Weldon	4	1

Operating guidelines on [352](#).

INSERTS

SHET110502FR-P 	SHET110505FR-P 	SHET110508FR-P
SHET110516FR-P 	SHET110524FN-P 	SHET110532FN-P

Part Number	Applications	Grade	IN15K							
SHET110502FR-P	Grd/Pol for Al - 0.008" R		●							
SHET110505FR-P	Grd/Pol for Al - 0.020" R		●							
SHET110508FR-P	Grd/Pol for Al - 0.031" R		●							
SHET110516FR-P	Grd/Pol for Al - 0.062" R		●							
SHET110524FN-P	Grd/Pol for Al - 0.093" R		●							
SHET110532FN-P	Grd/Pol for Al - 0.125" R		●							

● = P ● = M ● = K ● = N ○ = S

HARDWARE



Screw



Driver

SM40-093-20

DS-T15T

ALUMINATOR SERIES 15U1G (TOP-ON STYLE)

0 DEGREE LEAD HIGH SPEED ROUTER END MILL (ALUMINUM)



Shoulder



Channel



Ramping



Corkscrew



Pocket



Facing



Coolant

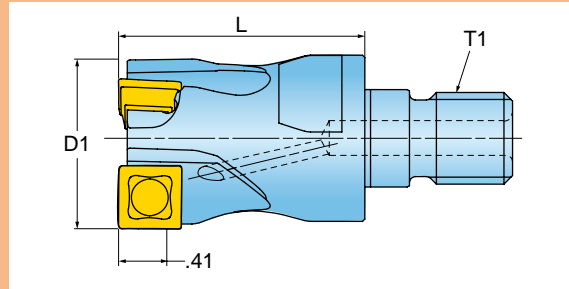

Cutter Number	D1 Nom. Dia.	T1 Adaption	L1 Extension Length	Number of Inserts	Wrench Size	Ramp Angle
15U1G-10015X7R01	1.000	M12	1.50	2	17mm	2
15U1G-12017X8R01	1.250	M16	1.75	3	22mm	6
15U1G-15017X8R01	1.500	M16	1.75	3	22mm	4

For Top-On shanks and adaptors, see [pages 730-737](#).
Operating guidelines on [352](#).

INSERTS

SHET110502FR-P

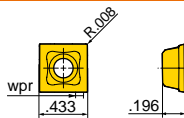

SHET110505FR-P

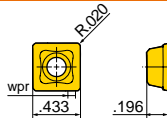

SHET110508FR-P

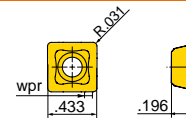

SHET110516FR-P

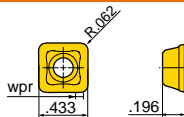

SHET110524FN-P

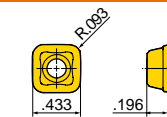

SHET110532FN-P

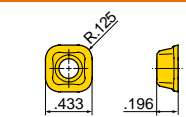

Part Number	Applications	Grade								
			IN15K							
SHET110502FR-P	Grd/Pol for Al - 0.008" R		●							
SHET110505FR-P	Grd/Pol for Al - 0.020" R		●							
SHET110508FR-P	Grd/Pol for Al - 0.031" R		●							
SHET110516FR-P	Grd/Pol for Al - 0.062" R		●							
SHET110524FN-P	Grd/Pol for Al - 0.093" R		●							
SHET110532FN-P	Grd/Pol for Al - 0.125" R		●							

● = P ● = M ● = K ● = N ○ = S

HARDWARE



Screw



Driver

SM40-093-20

DS-T15T

Ingersoll



CUTTING TOOLS

LONG-EDGE END MILLS.

Cutting Tools

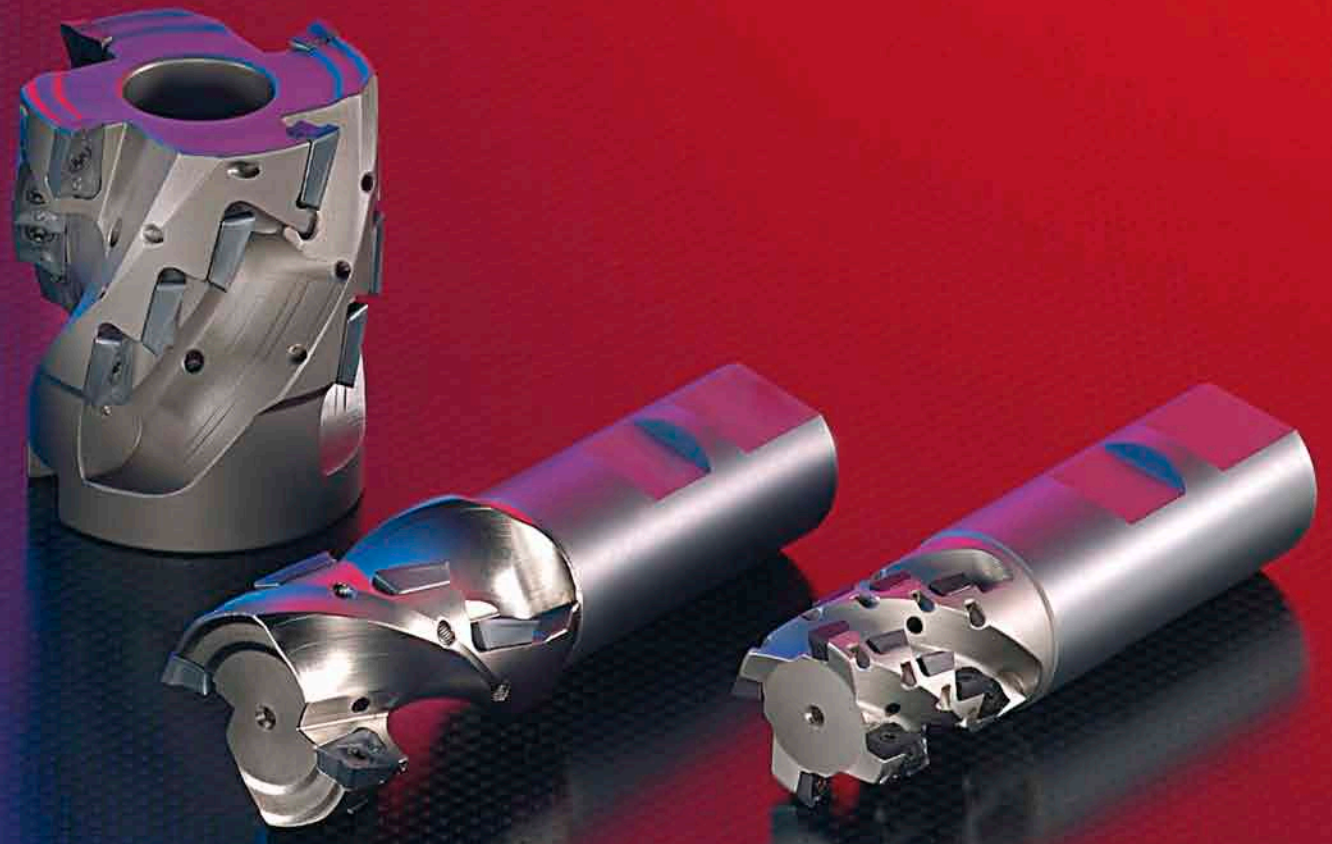







Member IMC Group
Ingersoll
Cutting Tools



LONG-EDGE END MILLS.

	Diameter	Cutting Length	Description	Series	Page
	.625 - 1.000	.65 - 1.27	HI-POS[®] 0° Lead Extended Flute End Mill	22J3D	70
	1.000 - 1.500	1.35 - 2.00	HI-POS⁺ 0° Lead Extended Flute End Mill	22J3P	71
	1.000 - 2.000	.92 - 3.80	HI-POS⁺ 0° Lead Extended Flute End Mill	22J3X	72
	2.00 - 2.500	1.73 - 2.60	HI-POS⁺ 0° Lead Extended Flute End Mill (Shell Mill)	22J3X (Shell Mill)	74
	1.500	1.74	HI-POS⁺ 0° Lead Extended Flute End Mill	22J3G	76
	1.500 - 2.000	1.66	HI-POS⁺ 0° Lead Fluted Precision End Mill	22J3E	78
	1.500 - 2.500	2.26 - 4.42	HI-POS⁺ 0° Fluted Precision Finishing End Mill (Inno-Fit Style)	22J3E (Inno-Fit Style)	80
	2.000	3.87	HI-POS⁺ 0° Lead Fluted Precision Finishing End Mill (V-Flange)	22J3E (V-Flange)	80
	2.000 - 4.000	1.74 - 3.78	HI-POS⁺ 0° Lead Fluted Precision Finishing Shell Mill	22J3E (Shell Mill)	82
	1.000 - 1.500	1.14 - 1.68	EVO-TEC[™] 0° Lead Extended Flute End Mill	2SJ3Y	84

	Diameter	Cutting Length	Description	Series	Page
	1.250 - 2.000	1.40 - 2.29	EVO•TEC™ 0° Lead Extended Flute End Mill	2SJ3F	85
	2.500 - 3.000	2.66 - 3.04	EVO•TEC™ 0° Lead Extended Flute Shell Mill	2SJ3F (Shell Mill)	86
	2.500 - 4.000	2.44 - 3.90	EVO•TEC™ 0° Lead Extended Flute Shell Mill	2SJ3J (Shell Mill)	87
	3.000 - 4.000	3.29 - 4.03	SoMAX™ 0° Lead Extended Flute Shell Mill	2SJ1H, 2SJ1L (Shell Mill)	88
	4.000	3.49	SoMAX™ 0° Lead Extended Flute Shell Mill	2SJ1N (Shell Mill)	89
	2.000	2.21 - 3.31	TETRA™ 0° Lead Extended Flute End Mill	2TJ3N	90
	2.500 - 4.000	2.74 - 3.28	TETRA™ 0° Lead Extended Flute Shell Mill	2TJ3N (Shell Mill)	91
	1.250 - 1.500	1.85 - 2.16	HI•POSQUAD™ 0° Lead Extended Flute End Mill	25J3F, 25J3G	92
	2.000 - 4.000	1.10 - 4.35	HI•POSQUAD™ 0° Lead Extended Flute Shell Mill	25J3G, 25J3J (Shell Mill)	93
	2.500	4.38 - 5.82	HI•POSQUAD™ 0° Replaceable End Cap End Mill Assembly	25J3J (End Cap Style)	94



LONG-EDGE END MILLS.

	Diameter	Cutting Length	Description	Series	Page
	2.000	4.00 - 4.50	HiPOSQUAD 0° Replaceable End Cap End Mill Cap	23J2G (End Cap Style)	96
	1.500 - 2.000	2.35 - 6.10	HiPOSQUAD 0° Lead Heavy-Duty Fluted End Mill	23J6G	98
	2.000 - 3.000	2.33 - 4.01	HiPOSQUAD 0° Lead Extended Flute End Mill	25J3H	100
	2.000 - 3.000	2.33 - 4.01	HiPOSQUAD 0° Lead Extended Flute Shell Mill	25J3H (Shell Mill)	102



0 DEGREE LEAD EXTENDED FLUTE END MILL

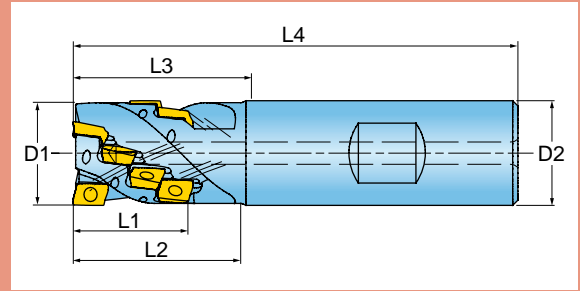

Cutter Number	D1 Nom. Dia.	L1 Length of Cut	L2 Projection Length	L3 Extension Length	L4 Overall Length	D2 Shank Size/Style	Number of Flutes Total	Number of Flutes Effective	Number of Inserts
22J3D-0601179R01	0.625	0.65	1.18	1.25	3.50	.625" Weldon	2	2	6
22J3D-0701484R01	0.750	0.86	1.43	1.50	3.50	.750" Weldon	3	3	12
22J3D-1001880R01	1.000	1.27	1.75	1.80	4.00	1.000" Weldon	4	4	24

In side stations, use insert with .015" R or smaller to ensure overlap.
Operating instructions on [page 347](#).

INSERTS

<p>AOCT060204FR-P</p>	<p>AOMT060202R</p>	<p>AOMT060204R</p>
<p>AOMT060208R</p>	<p>AOMT060216R</p>	

Part Number	Applications	Grade	IN05S	IN1030	IN2005	IN2030	IN2505				
AOCT060204FR-P	Grd/Pol for Al - 0.015" R		●								
AOMT060202R	Multi-Purpose - 0.008" R			●	●	●					
AOMT060204R	Multi-Purpose - 0.015" R			●	●	●	●				
AOMT060208R	Multi-Purpose - 0.031" R			●	●	●	●				
AOMT060216R*	Multi-Purpose - 0.062" R			●	●	●					

* Cutter body must be relieved to accept .062" R.

● = P ● = M ● = K ● = N ● = S

HARDWARE

Screw	Driver	Opt. Torque Driver Handle	Opt. Bit for DTN005S
SM18-041-00	DS-TP06S	DTN005S	DS-TP06TB

0 DEGREE LEAD EXTENDED FLUTE END MILL



Shoulder



Slabbing



Channel



Facing



Coolant

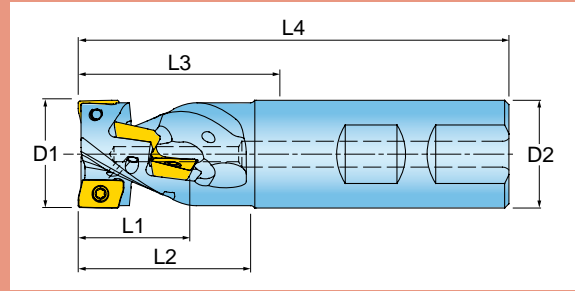

Cutter Number	D1 Nom. Dia.	L1 Max Depth of Cut	L2 Projection Length	L3 Extension Length	L4 Overall Length	D2 Shank Size/Style	Number of Flutes	Number of Inserts
22J3P-1001780R01	1.000	1.35	1.75	1.75	4.00	1.000" Weldon	2	8
22J3P-1202480R01	1.250	1.68	2.00	2.45	4.70	1.000" Weldon w/Flange	3	15
22J3P-1502881R01	1.500	2.00	2.36	2.80	5.00	1.250" Weldon w/Flange	4	24

In side stations, use insert with .015" R or smaller to ensure overlap.
Operating instructions on [page 349](#).

INSERTS

BOCT09T304FR-P

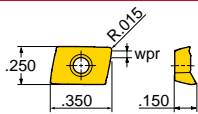

BOCT09T308FR-P

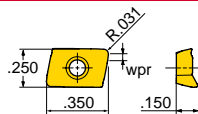

BOMT09T304R

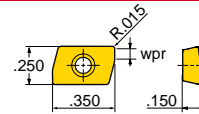

BOMT09T308R

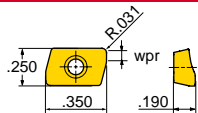

BOMT09T316R

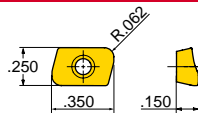

Part Number	Applications	Grade					
			IN10K	IN2030	IN2505		
BOCT09T304FR-P	Grd/Pol for Al - 0.015" R	●					
BOCT09T308FR-P	Grd/Pol for Al - 0.031" R	●					
BOMT09T304R	Multi-Purpose - 0.015" R		●	●			
BOMT09T308R	Multi-Purpose - 0.031" R		●	●			
BOMT09T316R	Multi-Purpose - 0.062" R		●	●			

● = P ● = M ● = K ● = N ○ = S

HARDWARE



Screw

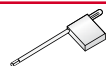

Driver

SM25-064-00

DS-T08W

0 DEGREE LEAD EXTENDED FLUTE END MILL

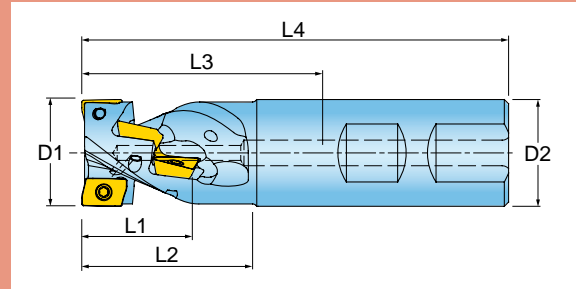

Cutter Number	D1 Nom. Dia.	L1 Max. Depth of Cut	L2 Projection Length	L3 Extension Length	L4 Overall Length	D2 Flange Diameter	Number of Effective Flutes	Number of Inserts
22J3X-1001680R01	1.000	0.92	1.50	1.60	3.85	1.000" Weldon	2	4
22J3X-1002080R01	1.000	1.35	1.64	2.02	4.27	1.000" Weldon w/Flange	2	6
22J3X-1002780R01	1.000	2.20	2.31	2.70	5.00	1.000" Weldon	2	10
22J3X-1201680R01	1.250	0.92	1.21	1.60	3.85	1.000" Weldon w/Flange	2	4
22J3X-1202480R01	1.250	1.76	2.07	2.45	4.70	1.000" Weldon w/Flange	3	12
22J3X-1203380R01	1.250	2.63	2.97	3.37	5.62	1.000" Weldon w/Flange	2	12
22J3X-1502381R01	1.500	1.35	2.31	2.31	4.56	1.250" Weldon w/Flange	3	9
22J3X-1502881R01	1.500	2.20	2.43	2.80	5.05	1.250" Weldon w/Flange	3	15
22J3X-1503429R01	1.500	2.20	2.43	3.93	6.61	#40 V-Flange	3	15
22J3X-1504484R01	1.500	2.20	3.23	4.45	7.03	#40 BT-Flange	3	15
22J3X-2002781R01	2.000	1.76	2.75	2.75	5.00	1.250" Weldon	4	16
22J3X-2005548R01	2.000	3.80	4.50	5.50	9.50	ICT #50 V-Flange	5	45

In side stations, use insert with .031" R or smaller to ensure overlap.
Operating instructions on [page 346](#).

INSERTS

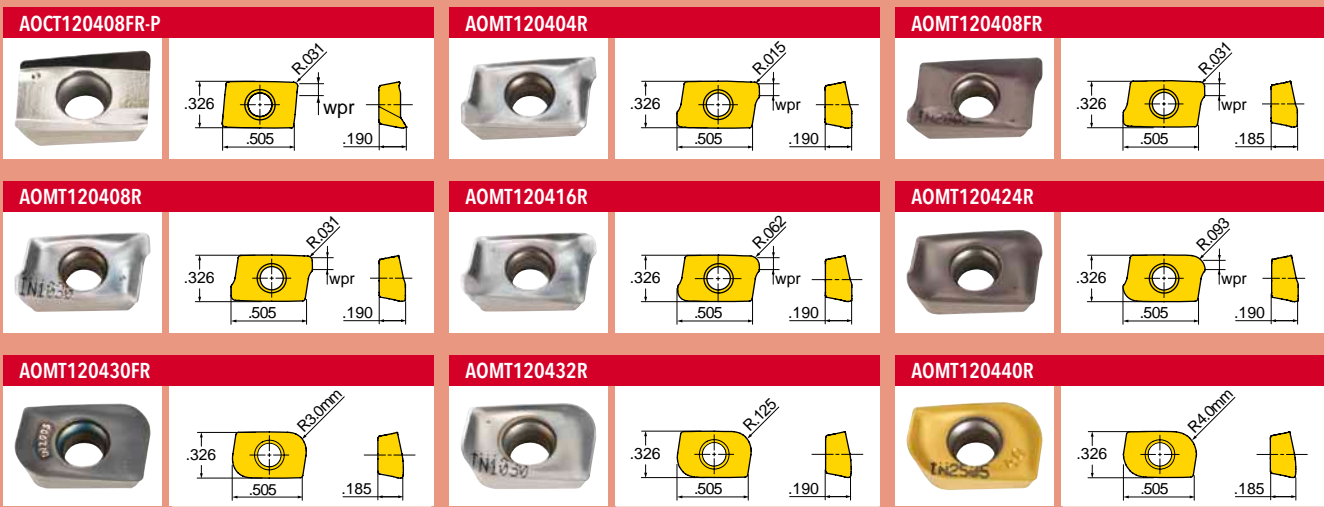

Part Number	Applications	Grade							
		IN1030	IN10K	IN2005	IN2010	IN2030	IN2040	IN2505	IN2510
AOCT120408FR-P	Grd/Pol for Al - 0.031" R		●						
AOMT120404R	Multi-Purpose - 0.015" R	●		●					
AOMT120408FR	Hi-Temp/Ti - 0.031" R			●		●			
AOMT120408R	Multi-Purpose - 0.031" R	●		●	●	●	●	●	
AOMT120416R	Multi-Purpose - 0.062" R	●		●		●			●
AOMT120424R	Multi-Purpose - 0.093" R			●		●			
AOMT120430FR	Multi-Purpose - 3.000 mm R			●					
AOMT120432R	Multi-Purpose - 0.125" R	●		●	●	●	●		
AOMT120440R*	Multi-Purpose - 4.000 mm R							●	

* Cutter body must be relieved to accept 4mm R.

● = P ● = M ● = K ● = N ○ = S

HARDWARE



Screw Driver

SM35-076-10 DS-T10T



HIPOST[™] SERIES 22J3X (SHELL MILL)

0 DEGREE LEAD EXTENDED FLUTE SHELL MILL

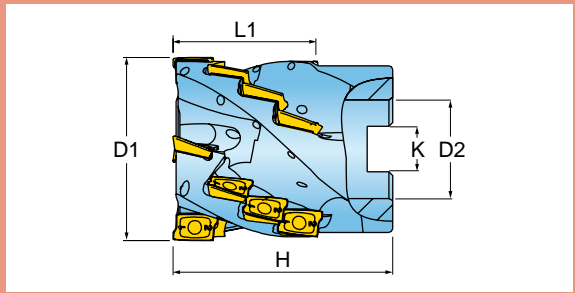
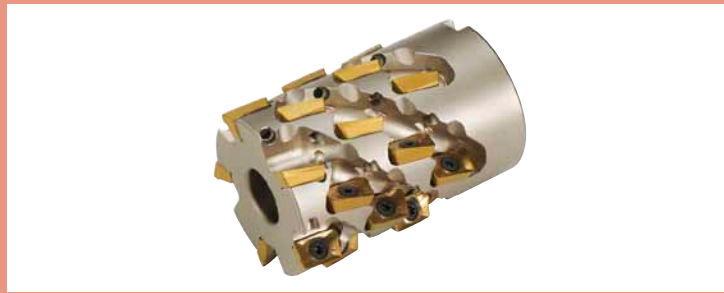

Cutter Number	D1 Nom. Dia.	L1 Length of Cut	H Height	D2 Bore Dia.	Keyway Width	No. of Flutes Effective	No. of Flutes Total	Total Inserts
22J3X-20022D1R01	2.000	1.73	2.20	0.750	0.312	3	3	12
22J3X-20025D1R01	2.000	2.16	3.00	0.750	0.312	5	5	25
22J3X-25030D3R01	2.500	2.60	3.50	1.000	0.375	5	5	30

* In side stations, use insert with .031" R or smaller to ensure overlap.
Operating instructions on [page 346](#).

INSERTS

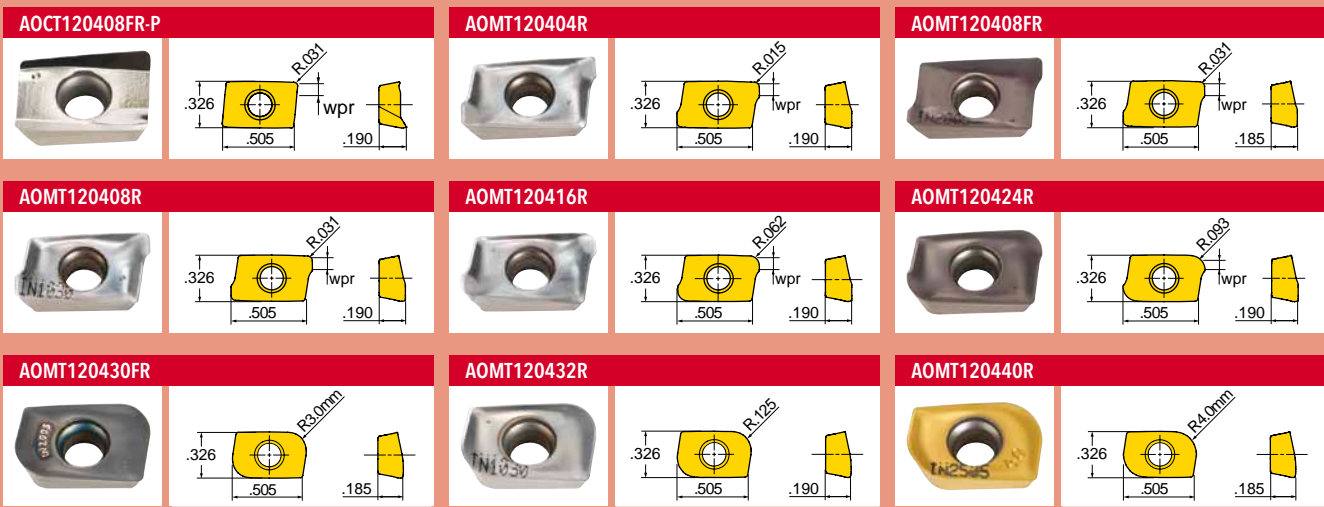

Part Number	Applications	Grade							
		IN1030	IN10K	IN2005	IN2010	IN2030	IN2040	IN2505	IN2510
AOCT120408FR-P	Grd/Pol for Al - 0.031" R		●						
AOMT120404R	Multi-Purpose - 0.015" R	●		●					
AOMT120408FR	Hi-Temp/Ti - 0.031" R			●		●			
AOMT120408R	Multi-Purpose - 0.031" R	●		●	●	●	●	●	
AOMT120416R	Multi-Purpose - 0.062" R	●		●		●			●
AOMT120424R	Multi-Purpose - 0.093" R			●		●			
AOMT120430FR	Multi-Purpose - 3.000 mm R			●					
AOMT120432R	Multi-Purpose - 0.125" R	●		●	●	●	●		
AOMT120440R*	Multi-Purpose - 4.000 mm R							●	

* Cutter body must be relieved to accept 4mm R.

● = P ● = M ● = K ● = N ○ = S

HARDWARE



	Screw	Driver	Retention Bolt
22J3X-2002D1R01	SM35-076-10	DS-T10T	SD-06-49
22J3X-20025D1R01	SM35-076-10	DS-T10T	SD-06-49
22J3X-25030D3R01	SM35-076-10	DS-T10T	SD-08-52



HIPOST⁺ SERIES 22J3G

0 DEGREE LEAD EXTENDED FLUTE END MILL

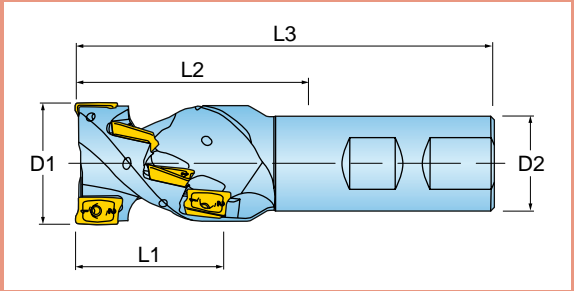

Cutter Number	D1 Nom. Dia.	L1 Length of Cut	L2 Extension Length	L3 Overall Length	D2 Shank Size/Style	Number of Flutes Effective	Number of Flutes Total	Number of Inserts
22J3G-1502581R01	1.500	1.74	3.25	5.50	1.250" Weldon	2	2	6

In side stations, use insert with .031" R or smaller to ensure overlap.
 Operating instructions on [page 346](#).

INSERTS

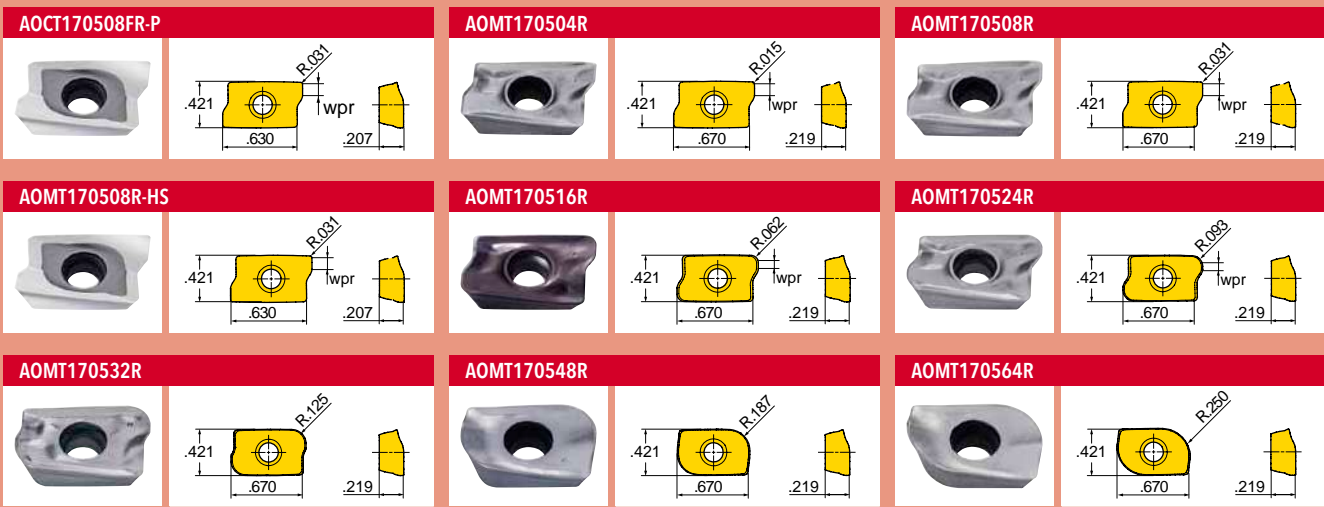

Part Number	Applications	Grade	IN1030	IN2005	IN2010	IN2030	IN2040	IN2505	IN2510	INDD15	IN10K
AOCT170508FR-P	Grd/Pol for Al - 0.031" R										●
AOMT170504R	Multi-Purpose - 0.015" R		●				●				
AOMT170508R	Multi-Purpose - 0.031" R		●	●		●	●	●	●	●	
AOMT170508R-HS	Hi-Temp/Ti - 0.031" R		●	●	●	●					
AOMT170516R	Multi-Purpose - 0.062" R		●	●	●	●					
AOMT170524R	Multi-Purpose - 0.093" R		●	●	●						
AOMT170532R	Multi-Purpose - 0.125" R		●	●			●				
AOMT170548R*	Multi-Purpose - 0.187" R		●	●			●				
AOMT170564R*	Multi-Purpose - 0.250" R		●	●						●	

* Cutter body must be relieved to accept radii. ● = P ● = M ● = K ● = N ○ = S

HARDWARE



Screw Driver

SM40-093-20 DS-T15T



0 DEGREE LEAD FLUTED PRECISION FINISHING END MILL

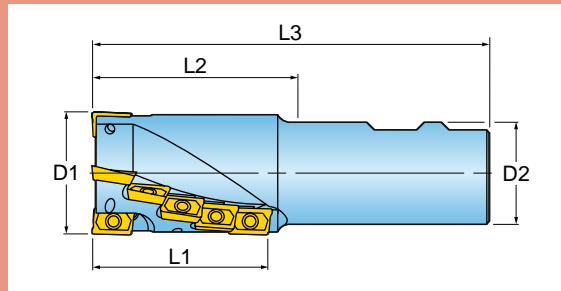

Cutter Number	D1 Nom. Dia.	L1 Max. Depth of Cut	L2 Extension Length	L3 Overall Length	D2 Shank Size/Style	No. of Flutes Effective	No. of Flutes Total	Number of Inserts
22J3E-1502381R01	1.500	1.66	2.33	4.58	1.250" Weldon	2	2	6
22J3E-2002381R01	2.000	1.66	2.33	4.58	1.250" Weldon	3	3	9

In side stations, use insert with .031" R or smaller to ensure overlap.
Operating instructions on [page 352](#).

INSERTS

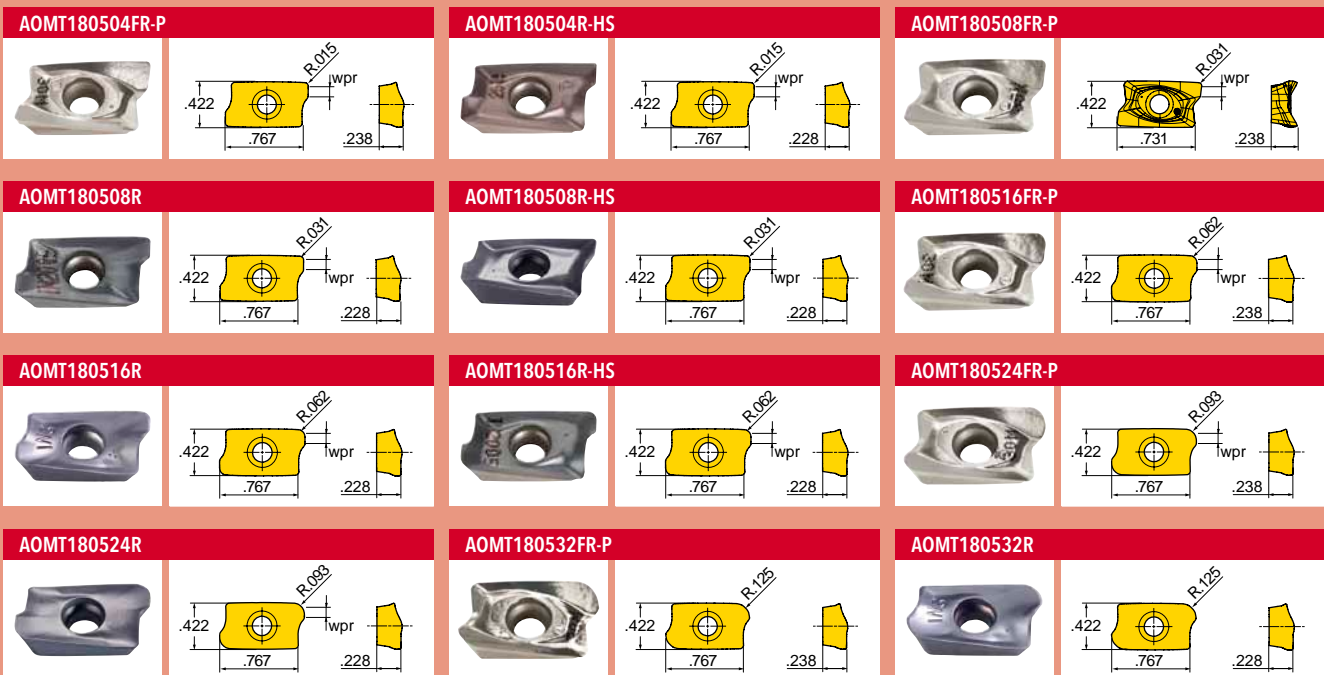

Part Number	Applications	Grade	IN05S	IN1030	IN2005	IN2015	IN2030	IN2040	IN30M		
AOMT180504FR-P	Grd/Pol for Al - 0.015" R		●								
AOMT180504R-HS	Hi-Temp/Ti - 0.015" R						●				
AOMT180508FR-P	Grd/Pol for Al - 0.031" R								●		
AOMT180508R	Multi-Purpose - 0.031" R			●	●	●	●	●			
AOMT180508R-HS	Hi-Temp/Ti - 0.031" R			●		●			●		
AOMT180516FR-P	Grd/Pol for Al - 0.062" R								●		
AOMT180516R	Multi-Purpose - 0.062" R			●	●	●	●	●			
AOMT180516R-HS	Hi-Temp/Ti - 0.062" R			●					●		
AOMT180524FR-P	Grd/Pol for Al - 0.093" R								●		
AOMT180524R	Multi-Purpose - 0.093" R			●	●			●			
AOMT180532FR-P	Grd/Pol for Al - 0.125" R								●		
AOMT180532R	Multi-Purpose - 0.125" R			●	●	●	●	●			

● = P ● = M ● = K ● = N ○ = S

HARDWARE



Screw

Driver

22J3E-1502381R01	SM40-093-20	DS-T15T
22J3E-2002381R01	SM40-120-20	DS-T15T



HIPOPOS⁺ SERIES 22J3E (INNO-FIT STYLE)

0 DEGREE FLUTED PRECISION FINISHING END MILL

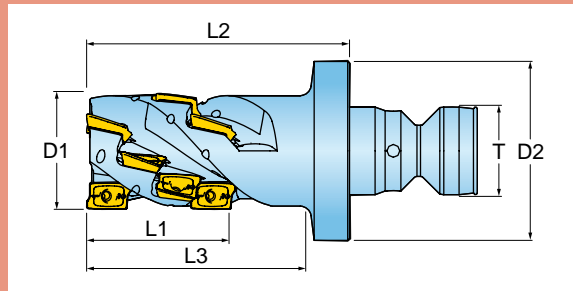

Cutter Number	D1 Nom. Dia.	L1 Max. Depth of Cut	L2 Extension Length	L3 Projection Length	T Shank Size/Style	D2 Flange Dia.	No. of Flutes Effective	No. of Flutes Total	Number of Inserts
22J3E-15035Z5R01	1.500	2.26	3.55	2.85	SK50	3.07	2	2	8
22J3E-20035Z5R01	2.000	2.26	3.55	2.85	SK50	3.07	3	3	12
22J3E-25055Z5R01	2.500	4.42	5.55	4.85	SK50	3.07	4	4	32

In side stations, use insert with .031" R or smaller to ensure overlap.
 For Inno-Fit master shanks and adaptors, see [pages 726-729](#).
 Operating instructions on [page 352](#).

HIPOPOS⁺ SERIES 22J3E (V-FLANGE)

0 DEGREE LEAD FLUTED PRECISION FINISHING END MILL

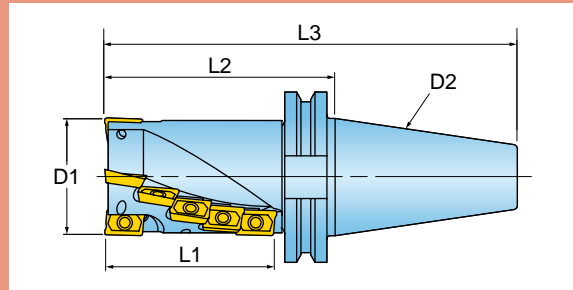

Cutter Number	D1 Nom. Dia.	L1 Max. Depth of Cut	L2 Extension Length	L3 Overall Length	D2 Shank Size/Style	No. of Flutes Eff. Side	No. of Flutes Eff. End	Number of Inserts
22J3E-2005548R01	2.000	3.87	5.50	9.50	ICT #50 V-Flange	3	3	21

In side stations, use .031" R or smaller to ensure overlap.
 Operating instructions on [page 352](#).

INSERTS

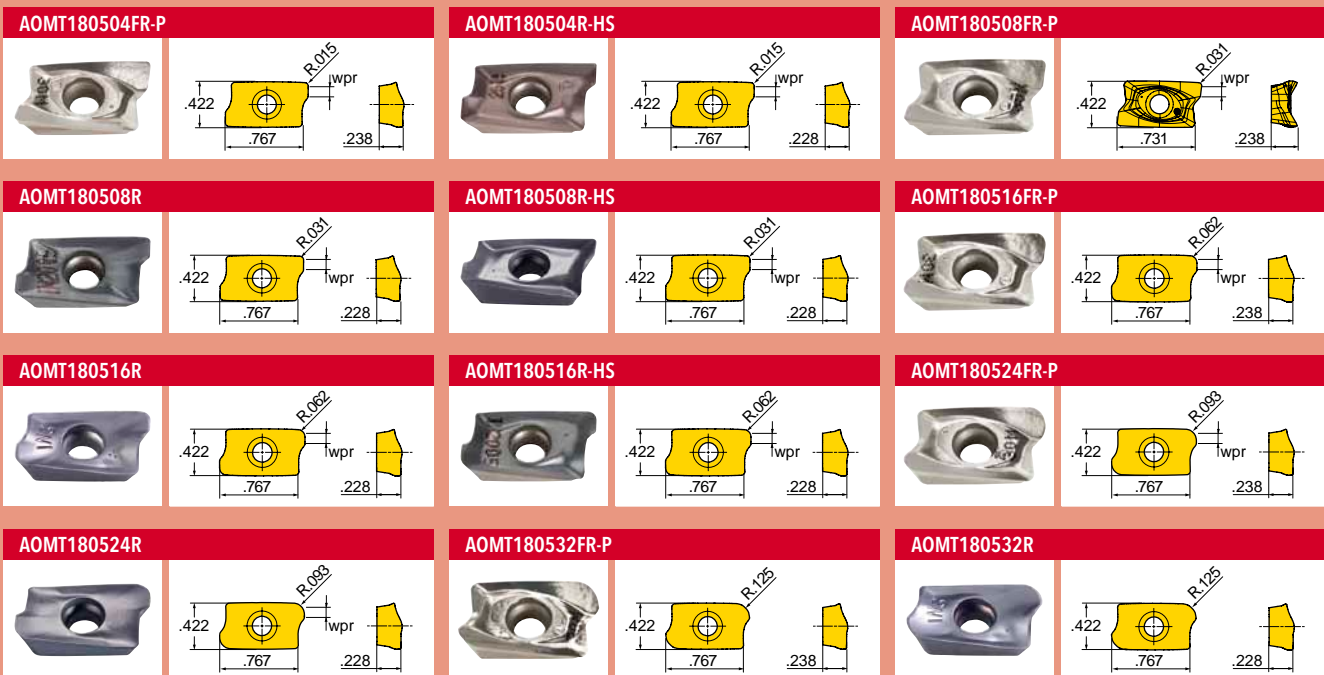

Part Number	Applications	Grade	IN05S	IN1030	IN2005	IN2015	IN2030	IN2040	IN30M		
AOMT180504FR-P	Grd/Pol for Al - 0.015" R		●								
AOMT180504R-HS	Hi-Temp/Ti - 0.015" R						●				
AOMT180508FR-P	Grd/Pol for Al - 0.031" R								●		
AOMT180508R	Multi-Purpose - 0.031" R			●	●	●	●	●			
AOMT180508R-HS	Hi-Temp/Ti - 0.031" R			●		●			●		
AOMT180516FR-P	Grd/Pol for Al - 0.062" R								●		
AOMT180516R	Multi-Purpose - 0.062" R			●	●	●	●	●			
AOMT180516R-HS	Hi-Temp/Ti - 0.062" R			●							
AOMT180524FR-P	Grd/Pol for Al - 0.093" R								●		
AOMT180524R	Multi-Purpose - 0.093" R			●	●			●			
AOMT180532FR-P	Grd/Pol for Al - 0.125" R								●		
AOMT180532R	Multi-Purpose - 0.125" R			●	●	●	●	●			

● = P ● = M ● = K ● = N ○ = S

HARDWARE



	Screw	Driver
22J3E-15035Z5R01	SM40-093-20	DS-T15T
22J3E-20035Z5R01	SM40-120-20	DS-T15T
22J3E-25055Z5R01	SM40-120-20	DS-T15T



HIOPoS⁺ SERIES 22J3E (SHELL MILL)

0 DEGREE LEAD FLUTED PRECISION FINISHING SHELL MILL

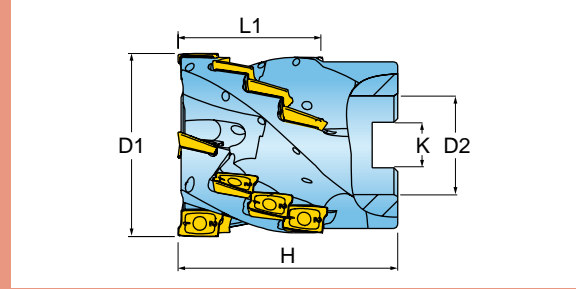

Cutter Number	D1 Nom. Dia.	L1 Length of Cut	H Height	D2 Bore Dia.	K Keyway Width	No. of Flutes Effective	No. of Flutes Total	Total Inserts	Coolant
22J3E-20022D1R01	2.000	1.74	2.25	0.750	0.312	4	4	12	Yes
22J3E-25030D3R01	2.500	2.26	3.06	1.000	0.375	4	4	16	No
22J3E-30033D4R01	3.000	2.76	3.36	1.250	0.500	4	4	20	No
22J3E-40044D5R01	4.000	3.78	4.47	1.500	0.625	5	5	35	No

In side stations, use .031" R or smaller to ensure overlap.
 Operating instructions on [page 352](#).

INSERTS

AOMT180504FR-P 	AOMT180504R-HS 	AOMT180508FR-P
AOMT180508R 	AOMT180508R-HS 	AOMT180516FR-P
AOMT180516R 	AOMT180516R-HS 	AOMT180524FR-P
AOMT180524R 	AOMT180532FR-P 	AOMT180532R
AOMT180548R 	AOMT180564R 	

Part Number	Applications	Grade								
		IN05S	IN1030	IN2005	IN2015	IN2030	IN2040	IN30M		
AOMT180504FR-P	Grd/Pol for Al - 0.015" R	●								
AOMT180504R-HS	Hi-Temp/Ti - 0.015" R					●				
AOMT180508FR-P	Grd/Pol for Al - 0.031" R							●		
AOMT180508R	Multi-Purpose - 0.031" R		●	●	●	●	●			
AOMT180508R-HS	Hi-Temp/Ti - 0.031" R			●		●		●		
AOMT180516FR-P	Grd/Pol for Al - 0.062" R							●		
AOMT180516R	Multi-Purpose - 0.062" R		●	●	●	●	●			
AOMT180516R-HS	Hi-Temp/Ti - 0.062" R			●				●		
AOMT180524FR-P	Grd/Pol for Al - 0.093" R							●		
AOMT180524R	Multi-Purpose - 0.093" R		●	●			●			
AOMT180532FR-P	Grd/Pol for Al - 0.125" R							●		
AOMT180532R	Multi-Purpose - 0.125" R		●	●	●	●	●			

● = P ● = M ● = K ● = N ○ = S

HARDWARE

	Screw	Driver	Retention Bolt
22J3E-20022D1R01	SM40-093-20	DS-T15T	SD-06-49
22J3E-25030D3R01	SM40-120-20	DS-T15T	SD-08-52
22J3E-30033D4R01	SM40-120-20	DS-T15T	SD-10-52
22J3E-40044D5R01	SM40-120-20	DS-T15T	SD-12-54

0 DEGREE LEAD EXTENDED FLUTE END MILL WITH 4 INDEXES

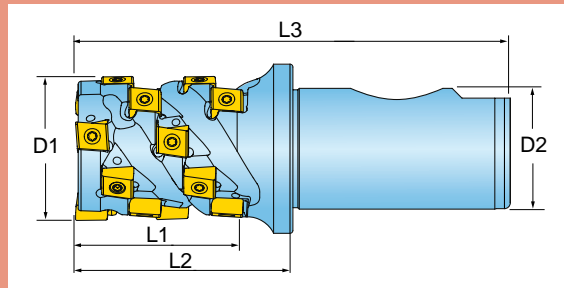
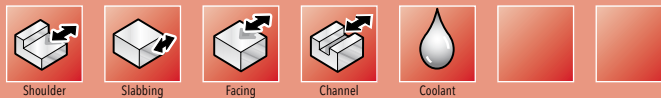

Cutter Number	D1 Nom. Dia.	L1 Length of Cut	L2 Extension Length	L3 Overall Length	D2 Shank Size/Style	Number of Effective Flutes	Number of Flutes Total	Number of Inserts
2SJ3Y-1001780R01	1.000	1.14	1.75	4.00	1.000" Weldon w/Flange	2	2	8
2SJ3Y-1201781R01	1.250	1.14	1.75	4.00	1.250" Weldon w/Flange	3	3	12
2SJ3Y-1502281R01	1.500	1.68	2.25	4.50	1.250" Weldon w/Flange	3	3	18

Operating instructions on [page 355](#).

INSERTS

DGM212R100

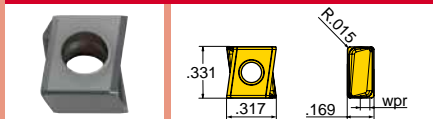

DGM212R101

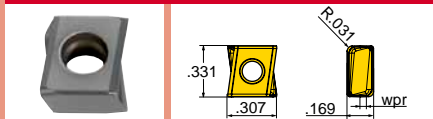

DGM212R103

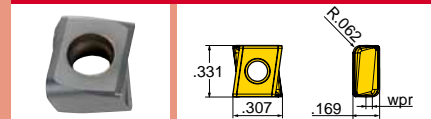

Part Number	Applications	Grade				
		IN2005	IN2015	IN2030		
DGM212R100	Multi-Purpose - 0.015" R	●	●	●		
DGM212R101	Multi-Purpose - 0.031" R	●	●	●		
DGM212R103*	Multi-Purpose - 0.062" R	●	●	●		

*End Station Only

● = P ● = M ● = K ● = N ○ = S

HARDWARE



Screw

Driver

SM30-082-21

DS-T08W

0 DEGREE LEAD EXTENDED FLUTE END MILL WITH 4 INDEXES

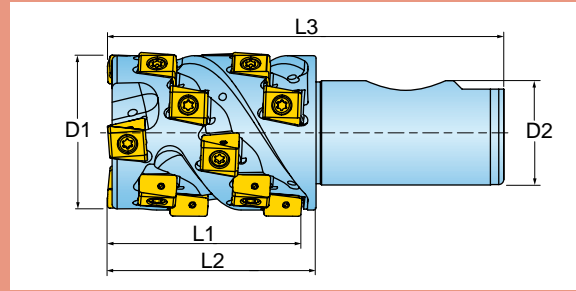

Cutter Number	D1 Nom. Dia.	L1 Length of Cut	L2 Extension Length	L3 Overall Length	D2 Shank Size/Style	Number of Effective Flutes	Number of Flutes Total	Number of Inserts
2SJ3F-1201781R01	1.250	1.40	1.75	4.00	1.250" Weldon w/Flange	2	2	6
2SJ3F-1502081R01	1.500	1.54	2.00	4.25	1.250" Weldon w/Flange	2	2	8
2SJ3F-2002581R01	2.000	2.29	2.50	4.75	1.250" Weldon w/Flange	3	3	18

Operating instructions on [page 356](#).

INSERTS

DGE314R001 	DGE314R002 	DGE314R004
DGM314R001 	DGM314R002 	DGM314R003
DGM314R004 		

Part Number	Applications	Grade								
		IN2005	IN2015	IN2030	IN2040	IN6515				
DGE314R001	SS/Hi-Temp/Ti - 0.031" R			●						
DGE314R002	SS/Hi-Temp/Ti - 0.062" R			●						
DGE314R004*	SS/Hi-Temp/Ti - 0.125" R			●						
DGM314R001	Multi-Purpose - 0.031" R	●	●	●	●	●				
DGM314R002	Multi-Purpose - 0.062" R	●	●	●	●	●				
DGM314R003*	Multi-Purpose - 0.093" R	●	●	●	●	●				
DGM314R004*	Multi-Purpose - 0.125" R	●	●	●	●	●				

*End Station Only

● = P ● = M ● = K ● = N ○ = S

HARDWARE



SM35-114-H0

DS-T15T

EVOO^{TEC}™ SERIES 2SJ3F (SHELL MILL)

0 DEGREE LEAD EXTENDED FLUTE SHELL MILL WITH 4 INDEXES

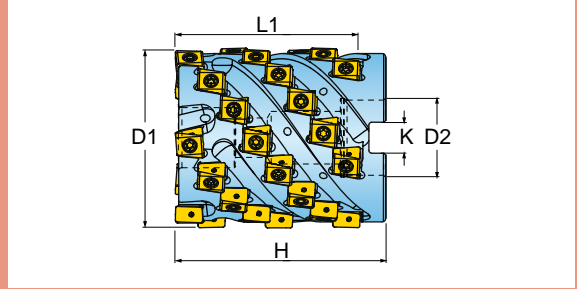

Cutter Number	D1 Nom. Dia.	L1 Length of Cut	H Height	D2 Bore Dia.	Keyway	Number of Effective Flutes	Number of Total Flutes	Number of Inserts
2SJ3F-25030D3R01	2.500	2.66	3.00	1.000	0.375	4	4	28
2SJ3F-30035D4R01	3.000	3.04	3.50	1.250	0.500	5	5	40

Operating instructions on [page 356](#).

INSERTS

DGE314R001	DGE314R002	DGE314R004
DGM314R001	DGM314R002	DGM314R003
DGM314R004		

Part Number	Applications	Grade							
		IN2005	IN2015	IN2030	IN2040	IN6515			
DGE314R001	SS/Hi-Temp/Ti - 0.031" R			●					
DGE314R002	SS/Hi-Temp/Ti - 0.062" R			●					
DGE314R004*	SS/Hi-Temp/Ti - 0.125" R			●					
DGM314R001	Multi-Purpose - 0.031" R	●	●	●	●	●			
DGM314R002	Multi-Purpose - 0.062" R	●	●	●	●	●			
DGM314R003*	Multi-Purpose - 0.093" R	●	●	●	●	●			
DGM314R004*	Multi-Purpose - 0.125" R	●	●	●	●	●			

*End Station Only

● = P ● = M ● = K ● = N ○ = S

HARDWARE



2SJ3F-25030D3R01	SM35-114-H0	DS-T15T	SD-08-50
2SJ3F-30035D4R01	SM35-114-H0	DS-T15T	SD-10-52

EVOOTEC™ SERIES 2SJ3J (SHELL MILL)

0 DEGREE LEAD EXTENDED FLUTE SHELL MILL WITH 4 INDEXES



Shoulder



Slabbing



Channel



Facing



Coolant

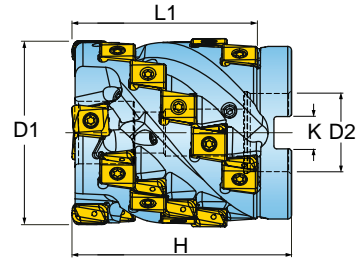

Cutter Number	D1 Nom. Dia.	L1 Length of Cut	H Height	D2 Bore Dia.	Keyway Width	No. of Flutes Effective	No. of Flutes Total	Total Inserts
2SJ3J-25030D3R01	2.500	2.44	3.00	1.000	0.375	3	3	15
2SJ3J-30035D4R01	3.000	2.92	3.50	1.250	0.500	4	4	24
2SJ3J-40045D5R01	4.000	3.90	4.50	1.500	0.625	5	5	40

Operating instructions [onpage 356](#).

INSERTS

DGE324R001

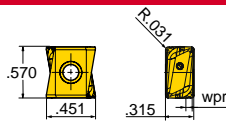

DGE324R002

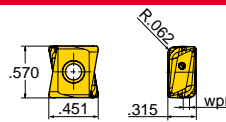

DGM324R001

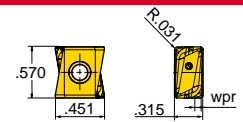

DGM324R002

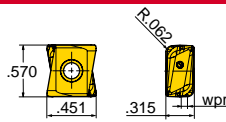

DGM324R003

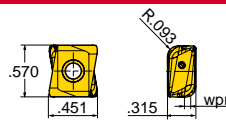

DGM324R201

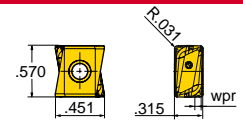

DGM324R202

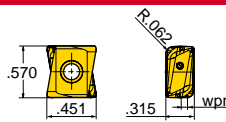

Part Number	Applications	Grade								
			IN2005	IN2015	IN2030	IN2040	IN6515			
DGE324R001	SS/Hi-Temp/Ti - 0.031" R				●					
DGE324R002	SS/Hi-Temp/Ti - 0.062" R				●					
DGM324R001	Multi-Purpose - 0.031" R		●	●	●	●	●			
DGM324R002	Multi-Purpose - 0.062" R		●	●	●	●	●			
DGM324R004*	Multi-Purpose - 0.125" R		●	●	●	●	●			
DGM324R201	Heavy-Duty - 0.031" R		●	●	●	●	●			
DGM324R202	Heavy-Duty - 0.062" R		●	●	●	●	●			

*End Station Only

● = P ● = M ● = K ● = N ○ = S

HARDWARE



Screw



Driver



Retention Bolt



Set Screw Style Office for coolant

2SJ3J-25030D3R01	SM40-143-H0	DS-T15T	SD-08-50	CZ-0090
2SJ3J-30035D4R01	SM40-143-H0	DS-T15T	SD-10-52	CZ-0090
2SJ3J-40045D5R01	SM40-143-H0	DS-T15T	SD12-54	CZ-0090

SOMAX™ SERIES 2SJ1H, 2SJ1L (SHELL MILL)

0 DEGREE LEAD EXTENDED FLUTE SHELL MILL WITH 4 INDEXES

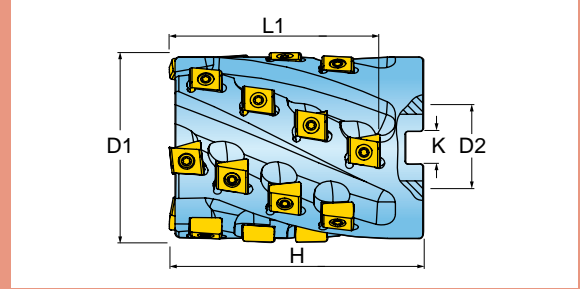

Cutter Number	D1 Nominal Diameter	L1 Max. DOC	H Height	D2 Bore Diameter	K Keyway	Number of Flutes Effective	Number Flutes Total	Total Number of Inserts	Accepts Insert Series
2SJ1H-30040D4R01	3.000	3.29	4.00	1.250	0.500	3	6	24	DPM324
2SJ1L-40047D5R01	4.000	4.03	4.75	1.500	0.625	3	6	24	DPM424
2SJ1L-40047D5R02	4.000	4.03	4.75	1.500	0.625	4	8	32	DPM424

Operating instructions on [page 354, 355](#).

INSERTS

DPM324R001	DPM324R002	DPM424R001
DTM324R001		

Part Number	Applications	Grade	IN1530	IN2005	IN2015	IN2040				
DPM324R001	Multi-Purpose - 0.031" R		●	●	●					
DPM324R002	Multi-Purpose - 0.062" R		●	●						
DPM424R001	Multi-Purpose - 0.031" R			●	●	●				
DTM324R001	Heavy-Duty - 0.031" R		●	●	●					

● = P ● = M ● = K ● = N ○ = S

HARDWARE



	Screw	Driver	Retention Bolt
2SJ1H-30040D4R01	SM40-120-20	DS-T15T	SD-10-54
2SJ1L-40047D5R01	SM50-160-10	DS-T20T	SD-12-79
2SJ1L-40047D5R02	SM50-160-10	DS-T20T	SD-12-79

0 DEGREE LEAD FLUTED SHELL MILL WITH 4 INDEXES



Shoulder



Slabbing



Channel



Facing

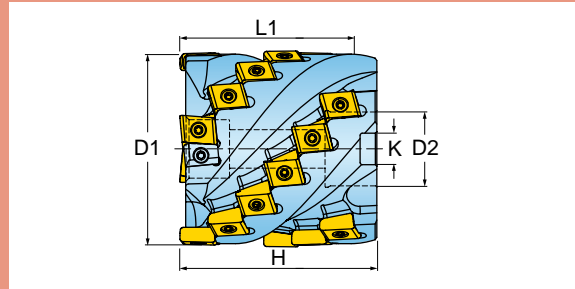

Cutter Number	D1 Nom. Dia.	Rotation	L1 Length of Cut	H Height	Adaption	D2 Bore Dia.	Keyway	Number of Effective Flutes	Number of Total Flutes	Number of Inserts
2SJ1N-40040D5L01	4.000	Left	3.49	4.00	Closed CBore	1.500	0.625	4	4	24
2SJ1N-40040D5R01	4.000	Right	3.49	4.00	Closed CBore	1.500	0.625	4	4	24

Operating instructions on [page 366](#).

INSERTS

DNM434L201

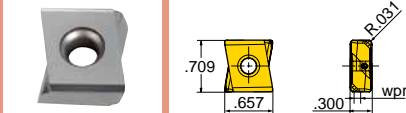

DNM434L202

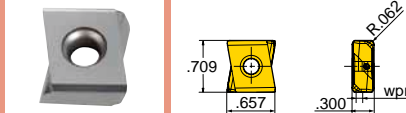

DNM434R201

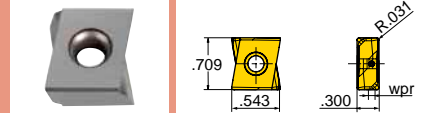

DNM434R202

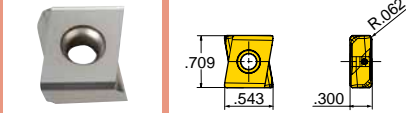

DNM434R203

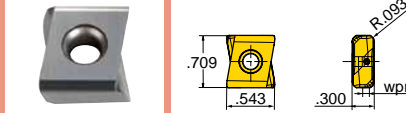

DNM434R204

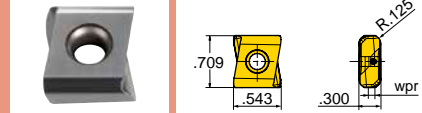

Part Number	Applications	Grade									
		IN2005	IN2015	IN2030	IN2040						
DNM434L201	Heavy-Duty - 0.031" R										
DNM434L202	Heavy-Duty - 0.062" R	●			●						
DNM434R201	Heavy-Duty - 0.031" R	●	●	●	●						
DNM434R202	Heavy-Duty - 0.062" R	●	●	●	●						
DNM434R203*	Heavy-Duty - 0.093" R	●									
DNM434R204*	Heavy-Duty - 0.125" R	●									

*End Station Only

● = P ● = M ● = K ● = N ○ = S

HARDWARE



Screw



Driver



Anvil



Retention Bolt

2SJ1N-40040D5R01	SM50-127-10	DS-T20T	PAR0636	SD12-54
2SJ1N-40040D5L01	SM50-127-10	DS-T20T	PAL0636	SD12-54

0 DEGREE LEAD EXTENDED FLUTE END MILL WITH 4 INDEXES

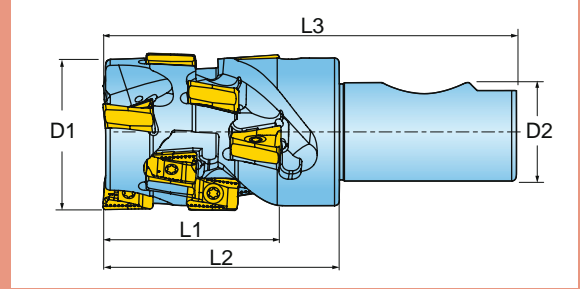

Cutter Number	D1 Effective Dia.	L1 Length of Cut	L2 Extension Length	L3 Overall Length	D2 Adaption Style	Number of Effective Flutes	Number of Total Flutes	Number of Inserts
2TJ3N-2003081R01	2.000	2.21	3.00	5.25	1.250" Weldon	3	3	21
2TJ3N-2005548R01	2.000	3.31	3.31	9.50	ICT #50 V-Flange	3	3	21

Operating instructions on [page 353](#).

INSERTS

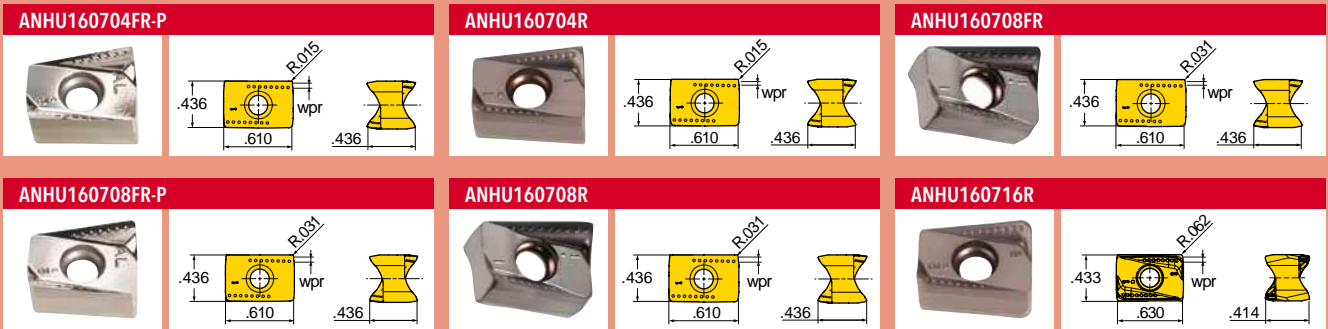

Part Number	Applications	Grade	IN10K	IN2010	IN2030	IN2505	IN2540	INDD15			
ANHU160704FR-P	Grd/Pol for Al - 0.015" R		●								
ANHU160704R	Multi-Purpose - 0.015" R				●						
ANHU160708FR	Hi-Temp/Ti - 0.031" R				●						
ANHU160708FR-P	Grd/Pol for Al - 0.031" R		●								
ANHU160708R	Multi-Purpose - 0.031" R			●	●	●	●	●			
ANHU160716R	Multi-Purpose - 0.062" R			●	●	●	●				

● = P ● = M ● = K ● = N ● = S

HARDWARE



Screw: SM40-093-20 Driver: DS-T15T

TETRA™ SERIES 2TJ3N (SHELL MILL)

0 DEGREE LEAD EXTENDED FLUTE SHELL MILL WITH 4 INDEXES



Shoulder



Slabbing



Channel



Facing



Coolant

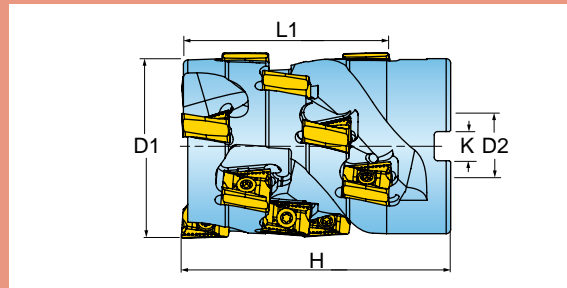

Cutter Number	D1 Nom. Dia.	L1 Length of Cut	D2 Bore Dia.	H Height	K Keyway	Number of Effective Flutes	Number of Total Flutes	Number of Inserts
2TJ3N-25036D3R01	2.500	2.74	1.000	3.60	0.375	3	3	15
2TJ3N-30040D4R01	3.000	3.28	1.250	4.00	0.500	4	4	24
2TJ3N-40040D5R01	4.000	3.28	1.500	4.00	0.625	5	5	30

Operating instructions on [page 353](#).

INSERTS

ANHU160704FR-P

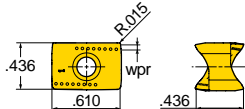

ANHU160704R

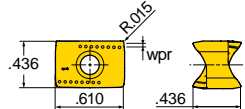

ANHU160708FR

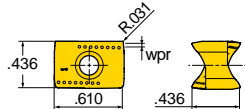

ANHU160708FR-P

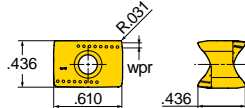

ANHU160708R

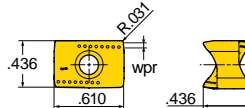

ANHU160716R

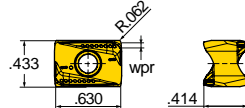

Part Number	Applications	Grade										
			IN10K	IN2010	IN2030	IN2505	IN2540	INDD15				
ANHU160704FR-P	Grd/Pol for Al - 0.015" R		●									
ANHU160704R	Multi-Purpose - 0.015" R				●							
ANHU160708FR	Hi-Temp/Ti - 0.031" R				●							
ANHU160708FR-P	Grd/Pol for Al - 0.031" R		●									
ANHU160708R	Multi-Purpose - 0.031" R			●	●	●	●	●	●			
ANHU160716R	Multi-Purpose - 0.062" R			●	●	●	●	●				

● = P ● = M ● = K ● = N ○ = S

HARDWARE



Screw



Driver



Retention Bolt

2TJ3N-25036D3R01	SM40-093-20	DS-T15T	SD-08-52
2TJ3N-30040D4R01	SM40-093-20	DS-T15T	SD-10-54
2TJ3N-40040D5R01	SM40-093-20	DS-T15T	SD12-54

0 DEGREE LEAD EXTENDED FLUTE END MILL

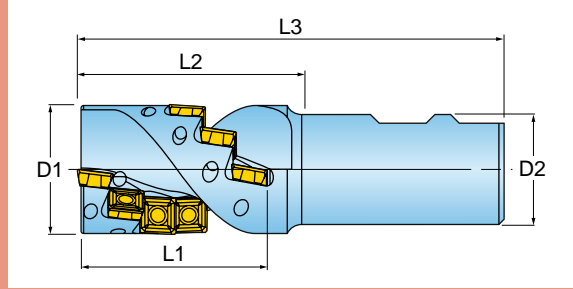

Cutter Number	D1 Nom. Dia.	L1 Max. Depth of Cut	L2 Extension Length	L3 Overall Length	D2 Shank Size/Style	No. of Flutes Effective	No. of Flutes Total	No. of Inserts	Insert Series
25J3F-1202281R01	1.250	1.85	2.25	4.50	1.250" Weldon	2	2	12	SHLT09
25J3G-1502681R01	1.500	2.16	2.60	4.85	1.250" Weldon	3	3	18	SHLT11

Operating instructions on [page 351](#).

INSERTS

SHLT090308N-HR		SHLT110408TN-HR			

Part Number	Applications	Grade	IN1030	IN2005	IN30M	IN40P	IN6530				
			SHLT090308N-HR	Multi-Purpose - 0.031" R							
SHLT110408TN-HR	Multi-Purpose - 0.031" R										

● = P ● = M ● = K ● = N ○ = S

HARDWARE

	Screw	Driver	Driver
25J3F-1202281R01	SM30-065-00	-	DS-T09W
25J3G-1502681R01	SM40-093-20	DS-T15T	-

HIPOPOSQUAD™ SERIES 25J3G, 25J3J (SHELL MILL)

0 DEGREE LEAD EXTENDED FLUTE SHELL MILL



Shoulder



Slabbing



Channel



Facing

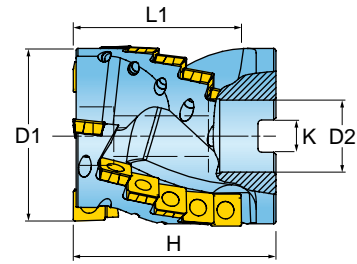

Cutter Number	D1 Nom. Dia.	L1 Max. Depth of Cut	H Height	D2 Bore Dia.	Keyway Width	Number of Flutes Effective	Number of Flutes Total	Number of Inserts	Insert Series
25J3G-20020D1R01	2.000	1.10	2.00	0.750	0.312	3	3	9	SHLT11
25J3G-20022D1R01	2.000	1.81	2.25	0.750	0.312	3	3	15	SHLT11
25J3J-25035D3R01	2.500	2.91	3.50	1.000	0.375	3	3	18	SHLT14
25J3J-30040D4R01	3.000	3.39	4.00	1.250	0.500	3	3	21	SHLT14
25J3J-40050D5R01	4.000	4.35	5.00	1.500	0.625	4	4	36	SHLT14

Operating instructions on [page 351](#).

INSERTS

SHLT110408TN-HR

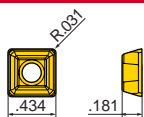

SHLT140508TN-HR

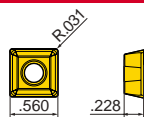

SHLT140516TN-HR

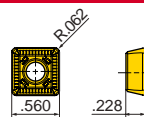

Part Number	Applications	Grade						
			IN1030	IN1530	IN2005	IN30M	IN40P	IN6530
SHLT110408TN-HR	Multi-Purpose - 0.031" R		●●		●●	●●	●●	●●
SHLT140508TN-HR	Multi-Purpose - 0.031" R		●●		●●	●●	●●	●●
SHLT140516TN-HR	Multi-Purpose - 0.062" R			●●	●●			

● = P ● = M ● = K ● = N ○ = S

HARDWARE



Screw



Driver



Retention Bolt

25J3G-20020D1R01	SM40-093-20	DS-T15T	SD-06-48
25J3G-20022D1R01	SM40-093-20	DS-T15T	SD-06-49
25J3J-25035D3R01	SM50-127-10	DS-T20T	SD-08-52
25J3J-30040D4R01	SM50-127-10	DS-T20T	SD-10-54
25J3J-40050D5R01	SM50-127-10	DS-T20T	SD-12-79



HIPOPOSQUAD™ SERIES 25J3J (END CAP STYLE)

0° REPLACEABLE END CAP END MILL ASSEMBLY

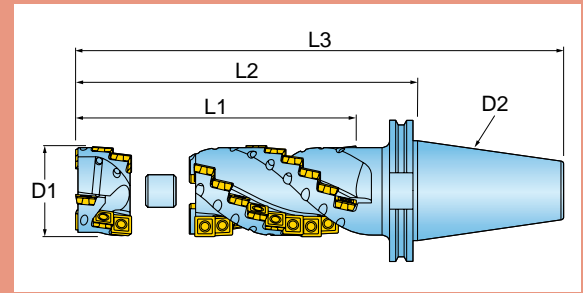
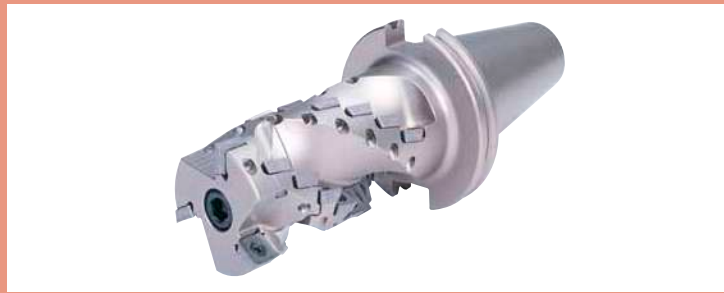

D1 Nominal Dia.	Cutter Assembly	L1 Max. Depth of Cut	L2 Extension Length	L3 Overall Length	D2 Shank Size/Style	No. of Flutes Effective	No. of Flutes Total
2.500	25J3J-2506048A01	4.38	6.00	10.00	50 V-Flange	3	3
2.500	25J3J-2507548A01	5.82	7.50	11.50	50 V-Flange	3	3

Operating instructions on [page 351](#).

ASSEMBLY COMPONENTS

Cutter Assembly	Body	End Cap	Centering Bushing	Retention Bolt
25J3J-2506048A01	25J3J-25HL448R01	25J3J-25EC172R01	PZ-0500	SD-07-06
25J3J-2507548A01	25J3J-25HL648R01	25J3J-25EC172R01	PZ-0500	SD-07-06

INSERTS



Assembly Type	Part Number	Insert Qty.	Insert Number	Application	Corner	GRADE	IN30M	IN40P	IN6530	IN2005	IN1030		
Cutter Body	25J3J-25HL448R01	18	SHLT140508TN-HR	Multi-Purpose	.031R								
Cutter Body	25J3J-25HL648R01	27	SHLT140508TN-HR	Multi-Purpose	.031R								
End Cap	25J3J-25EC172R01	9	SHLT140508TN-HR	Multi-Purpose	.031R								

● = P ● = M ● = K ● = N ○ = S

HARDWARE

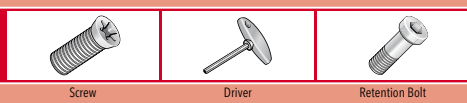

Screw Driver Retention Bolt

SM50-127-10	DS-T20T	SD-07-06
-------------	---------	----------

HI-POSQUAD™ SERIES 23J2G (END CAP STYLE)

0° LEAD REPLACEABLE END CAP END MILL ASSEMBLY

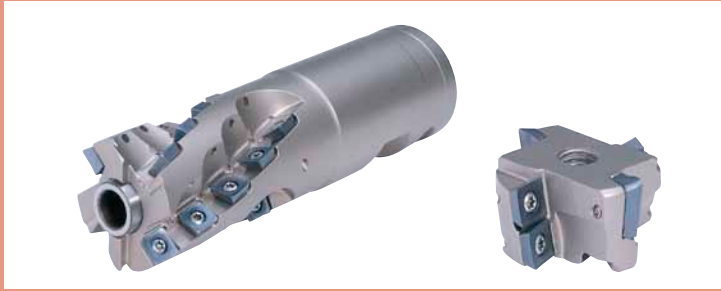

Drawing A-
Rear Mounted Style

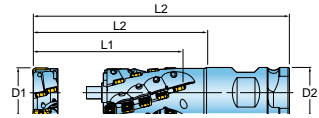

Drawing B-
Face Mounted Style

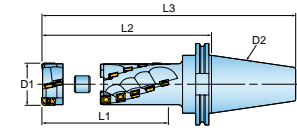

D1 Nominal Diameter	Cutter Assembly	End Cap Mounting Type	L1 Max. Depth of Cut	L2 Extension	L3 Overall Length	D2 Shank Size/Style	No. of Flutes Eff. Side	No. of Flutes Eff. End	Total Flutes
2.000	23J2G-2005052A02	Rear	4.50	5.00	8.25	2.000 Wel/Put	2	2	4
2.000	23J2G-2006148A02	Face	4.00	6.13	10.13	50 V-Flange	2	2	4

Operating instructions on [page 351](#).

ASSEMBLY COMPONENTS

Cutter Assembly	Body	End Cap	Centering Bushing	Retention Bolt	Drawing Type
23J2G-2005052A02	23J2G-20HL452R01	23J2G-20EC172R02	PZ-0499	SD08LA2	A
23J2G-2006148A02	23J2G-20HL548R01	23J2G-20EC168R02	PZ-0499	SD08-21	B

INSERTS

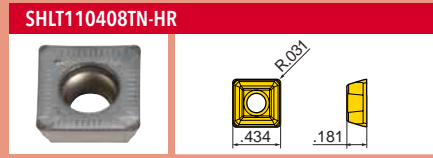
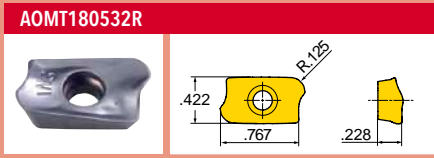
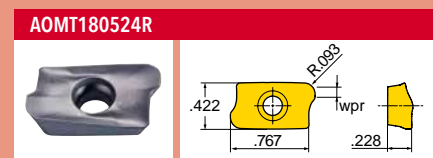
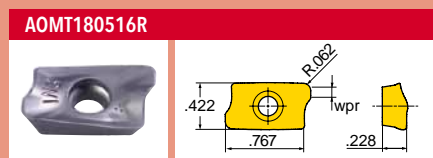
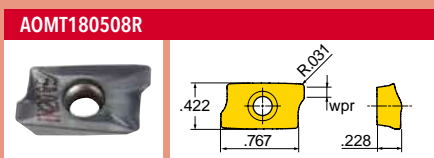

Qty	Part Number	Applications	Grade	IN1030	IN2005	IN2015	IN2030	IN2040	IN30M				
-----	-------------	--------------	-------	--------	--------	--------	--------	--------	-------	--	--	--	--

End Cap End Inserts

2	AOMT180504R-HS	Hi-Temp/Ti - 0.015" R											
2	AOMT180508R	Multi-Purpose - 0.031" R		●	●	●	●	●					
2	AOMT180508R-HS	Hi-Temp/Ti - 0.031" R			●		●			●			
2	AOMT180516R	Multi-Purpose - 0.062" R		●	●	●	●	●					
2	AOMT180516R-HS	Hi-Temp/Ti - 0.062" R			●								
2	AOMT180524R	Multi-Purpose - 0.093" R		●	●				●				
2	AOMT180532R	Multi-Purpose - 0.125" R		●	●	●	●	●					

Qty	Part Number	Applications	Grade	IN1030	IN2005	IN30M	IN40P	IN6530					
-----	-------------	--------------	-------	--------	--------	-------	-------	--------	--	--	--	--	--

End Cap Side Inserts

4	SHLT110408TN-HR	Multi-Purpose - 0.031" R		●	●	●	●	●					
---	-----------------	--------------------------	--	---	---	---	---	---	--	--	--	--	--

Body Inserts

18	SHLT110408TN-HR	Multi-Purpose - 0.031" R		●	●	●	●	●					
----	-----------------	--------------------------	--	---	---	---	---	---	--	--	--	--	--

● = P ● = M ● = K ● = N ○ = S

HARDWARE

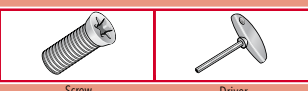

23J2G-2005052A02	SM40-120-20	DS-T15T (Tx-15)
23J2G-2006148A02	SM40-120-20	DS-T15T (Tx-15)



0 DEGREE LEAD HEAVY-DUTY FLUTED END MILL

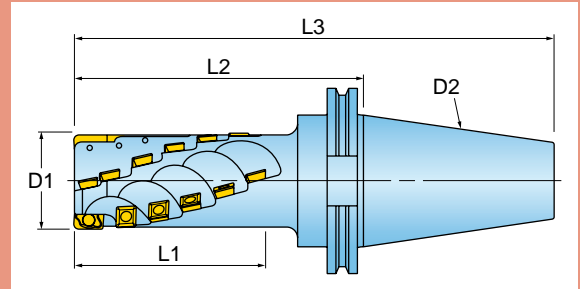

Cutter Number	D1 Nom. Dia.	L1 Max. Depth of Cut	L2 Extension Length	L3 Overall Length	D2 Shank Size/Style	No. of Flutes Effective	No. of Flutes total	No. of Inserts End	No. of Inserts Side
23J6G-1502881R00	1.500	2.35	2.87	5.12	1.250" Weldon	2	4	2	12
23J6G-2003081R00	2.000	2.67	3.00	5.25	1.250" Weldon w/Flange	2	4	2	14
23J6G-2005052R00	2.000	4.39	5.00	8.25	2.000 Weldon Putnam	2	4	2	24
23J6G-2006148R00	2.000	4.04	6.12	10.12	ICT #50 V-Flange	2	4	2	22
23J6G-2006145R00	2.000	4.04	6.12	11.12	#50 NMTB	2	4	2	22
23J6G-2008048R00	2.000	6.10	8.00	12.00	ICT #50 V-Flange	2	4	2	34

Operating instructions on [page 351](#).

INSERTS

AOMT180508R

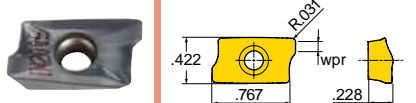

AOMT180516R



AOMT180524R

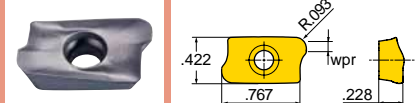

AOMT180532R

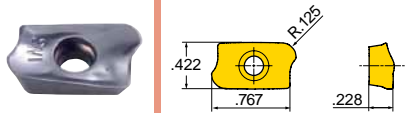

SHLT110408TN-HR



Part Number	Applications	Grade										
			IN1030	IN2005	IN2015	IN2030	IN2040	IN30M	IN40P	IN6530		
AOMT180508R	Multi-Purpose - 0.031" R		●	●	●	●	●					
AOMT180516R	Multi-Purpose - 0.062" R		●	●	●	●	●					
AOMT180524R	Multi-Purpose - 0.093" R		●	●	●	●	●					
AOMT180532R	Multi-Purpose - 0.125" R		●	●	●	●	●					
SHLT110408TN-HR	Multi-Purpose - 0.031" R		●	●						●	●	●

● = P ● = M ● = K ● = N ● = S

HARDWARE



Screw

SM40-093-20



Driver

DS-T15T

0 DEGREE LEAD EXTENDED FLUTE END MILL

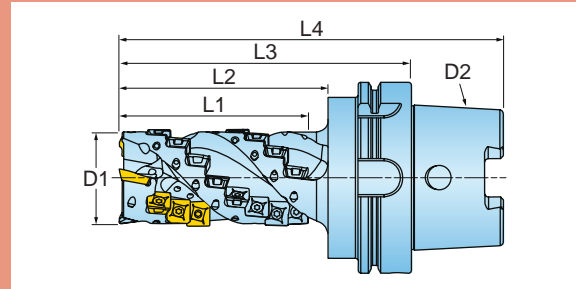

Cutter Number	D1 Effective Diameter	L1 Length of Cut	L2 Projection Length	L3 Extension Length	L4 Overall Length	D2 Shank Size/Style	Number Effective Flutes	Number Inserts End	Number Inserts Side
25J3H-2002781R01	2.000	2.33	-	2.75	5.00	1.250" Weldon w/Flange	3	3	12
25J3H-2004224R01	2.000	3.59	-	4.25	5.62	SK40	3	3	21
25J3H-2006048R01	2.000	4.01	4.63	6.00	10.00	ICT #50 V-Flange	3	3	24
25J3H-20060B5R01	2.000	4.01	5.50	6.00	10.01	#50 BT-Flange	3	3	24
25J3H-20062H1R01	2.000	4.01	4.72	6.00	8.21	HSK-100-A	3	3	24
25J3H-30062H1R01	3.000	4.01	4.72	6.00	8.21	HSK-100-A	4	4	32

Operating instructions on [page 351](#).

INSERTS

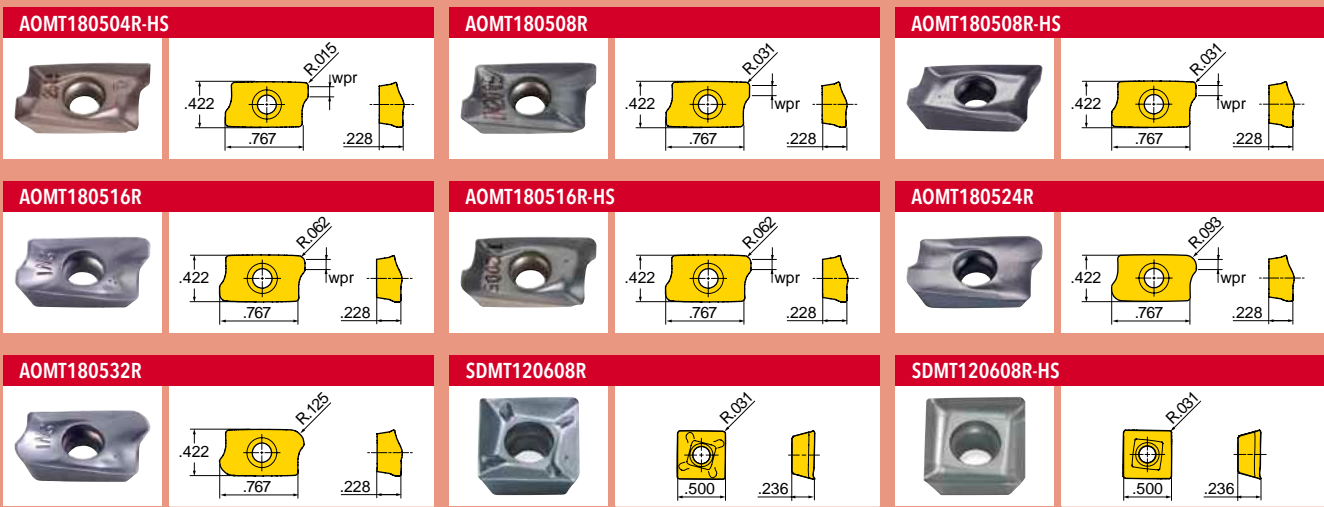

Part Number	Applications	Grade	IN1030	IN2005	IN2015	IN2030	IN2040	IN30M	IN5015		
AOMT180504R-HS	Hi-Temp/Ti - 0.015" R					●					
AOMT180508R	Multi-Purpose - 0.031" R		●	●	●	●	●				
AOMT180508R-HS	Hi-Temp/Ti - 0.031" R			●	●	●			●		
AOMT180516R	Multi-Purpose - 0.062" R		●	●	●	●	●				
AOMT180516R-HS	Hi-Temp/Ti - 0.062" R			●	●						
AOMT180524R	Multi-Purpose - 0.093" R		●	●			●				
AOMT180532R	Multi-Purpose - 0.125" R		●	●	●	●	●				
SDMT120608R	Multi-Purpose - 0.031" R		●	●	●				●		
SDMT120608R-HS	Hi-Temp/Ti - 0.031" R			●		●					

● = P ● = M ● = K ● = N ● = S

HARDWARE



Screw Driver

SM40-120-20 DS-T15T



HI-POSQUAD™ SERIES 25J3H (SHELL MILL)

0 DEGREE LEAD EXTENDED FLUTE SHELL MILL

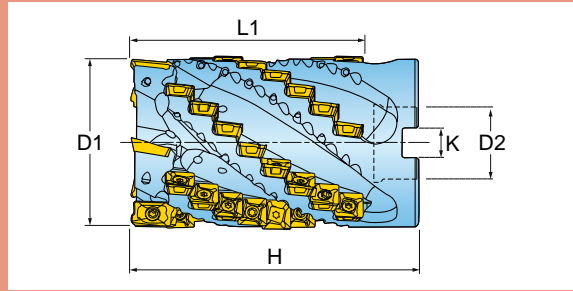
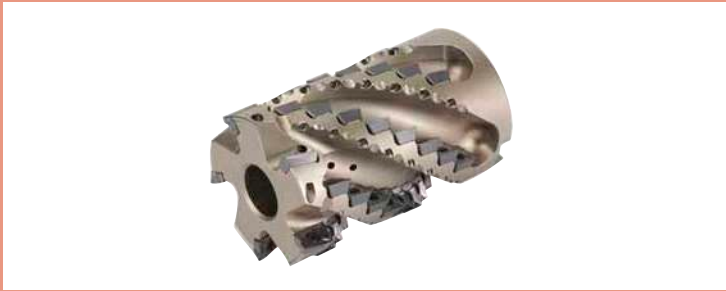

Cutter Number	D1 Nom. Dia.	L1 Length of Cut	H Height	D2 Bore Dia.	Keyway Width	No. of Flutes Effective	No. of Flutes Total	Total Inserts
25J3H-25040D3R01	2.500	3.17	4.00	1.000	0.375	4	4	24
25J3H-30050D4R01	3.000	4.01	5.00	1.250	0.500	4	4	32
25J3H-30050D4R11	3.000	4.01	5.00	1.250	0.500	5	5	40
25J3H-40047D5R01	4.000	4.01	4.75	1.500	0.625	5	5	40

Operating instructions on [page 351](#).

INSERTS

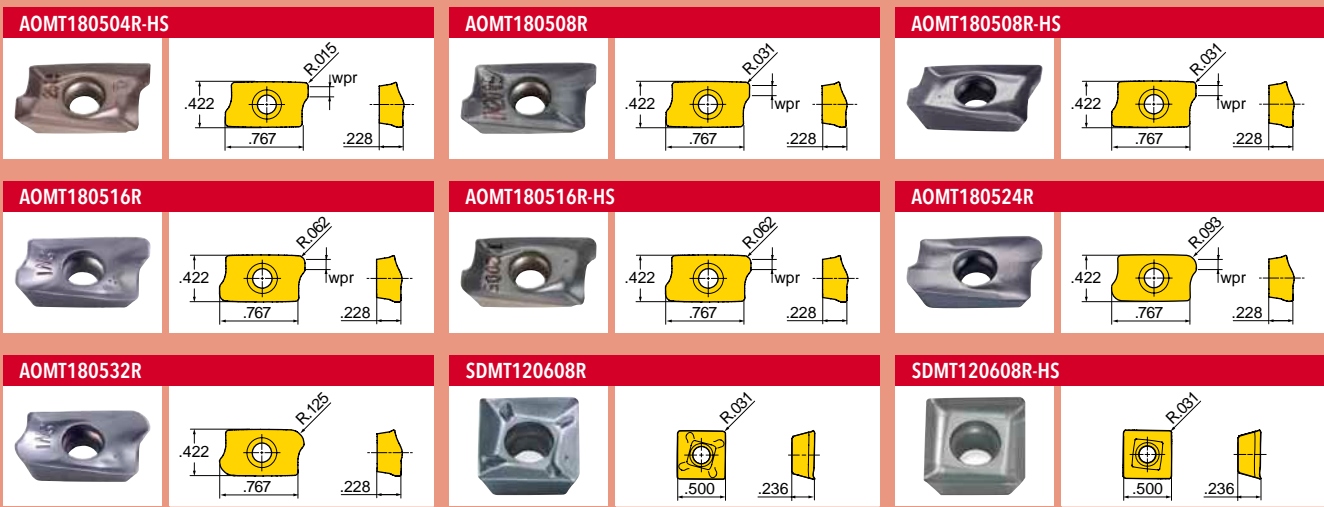

Part Number	Applications	Grade	IN1030	IN2005	IN2015	IN2030	IN2040	IN30M	IN5015		
			AOMT180504R-HS	Hi-Temp/Ti - 0.015" R					●		
AOMT180508R	Multi-Purpose - 0.031" R		●	●	●	●	●				
AOMT180508R-HS	Hi-Temp/Ti - 0.031" R			●		●			●		
AOMT180516R	Multi-Purpose - 0.062" R		●	●	●	●	●				
AOMT180516R-HS	Hi-Temp/Ti - 0.062" R			●							
AOMT180524R	Multi-Purpose - 0.093" R		●	●			●				
AOMT180532R	Multi-Purpose - 0.125" R		●	●	●	●	●				
SDMT120608R	Multi-Purpose - 0.031" R		●	●	●					●	
SDMT120608R-HS	Hi-Temp/Ti - 0.031" R			●		●					

● = P ● = M ● = K ● = N ● = S

HARDWARE



	Screw	Driver	Retention Bolt
25J3H-25040D3R01	SM40-120-20	DS-T15T	SD08-81
25J3H-30050D4R01	SM40-120-20	DS-T15T	SD10-A2
25J3H-30050D4R11	SM40-120-20	DS-T15T	SD10-A2
25J3H-40047D5R01	SM40-120-20	DS-T15T	SD12-54

Ingersoll



CUTTING TOOLS
CUTTING TOOLS





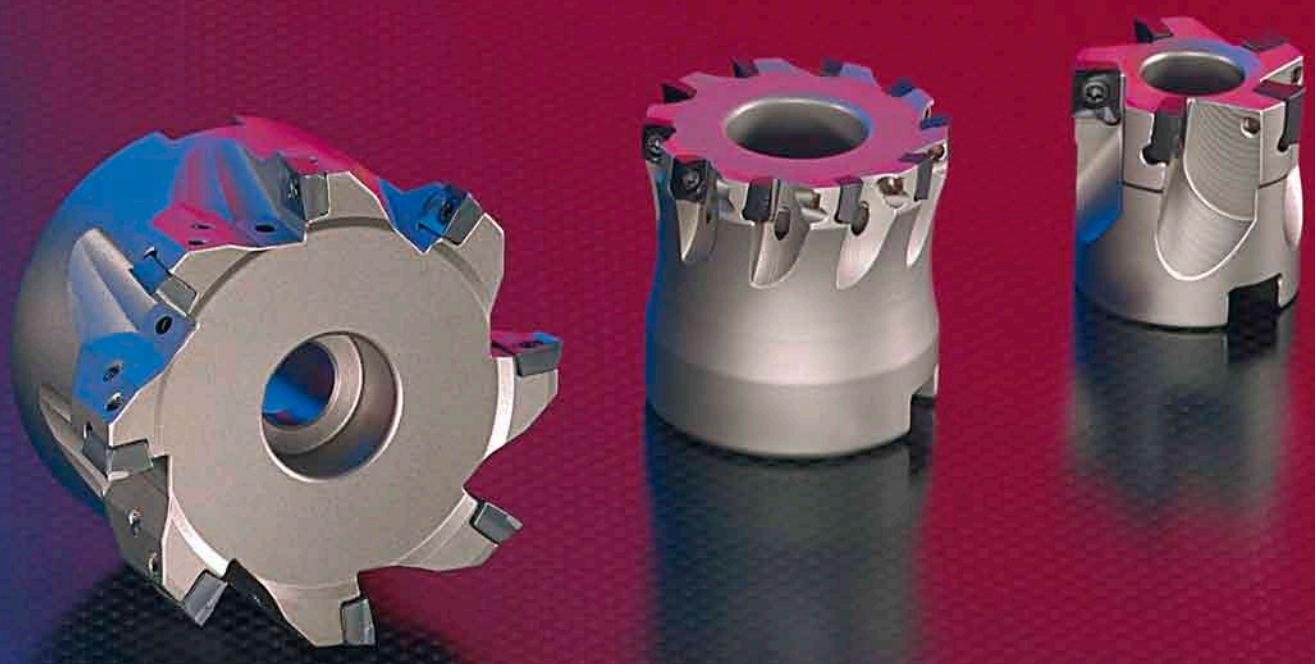





0° FACE MILLS.











Cutting Tools













Member IMC Group
Ingersoll
Cutting Tools

0° FACE MILLS.

	Diameter	Cut Length	Description	Series	Page
	1.500 - 2.000	.22	Hi-POS® 0° Lead Face Mill	2J1D	110
	1.500 - 3.000	.35	Hi-POS+ 0° Lead Face Mill	2J1P	111
	1.500 - 4.000	.50	Hi-POS+ 0° Lead Face Mill	2J1X	112
	3.000	.21	Hi-POS+ 15° Lead Face Mill	2L1X	112
	2.000 - 8.000	.69	Hi-POS+ 0° Lead Face Mill	2J1G	114
	2.000 - 8.000	.68	Hi-POS+ 0° Lead Face Mill	2J1E, 2J4E	116
	2.500 - 4.000	..31	Hi-POS+ 15° Lead Face Mill	2L1E	118
	2.000 - 8.000	.59	TETRA™ 0° Lead Face Mill	TJ6N	120
	1.500 - 3.000	.31	Hi-POSQUAD™ 0° Lead Face Mill	5J1E	122
	2.000 - 6.000	.41	ALUMINATOR 0° Lead High-Speed Router Face Mill (Aluminum)	5H6G	124

	Diameter	Cut Length	Description	Series	Page
	2.000 - 4.000	.47	HI-POSQUAD 0° Lead Face Mill	5J1H	126
	2.000 - 6.000	.24	IRON-EATER 0° Lead SiNi Face Mill	5J2H	127
	2.000 - 8.000	.04	QUAD-PLUS FINISH 0° Lead Adjustable Finishing Face Mill	DJ1H	128
	2.000 - 8.000	.47	ISO-PLUS 0° Lead Face Mill	DJ6T, DJ5T	130
	2.500 - 6.000	.59	ISO-PLUS 0° Lead Face Mill	DJ6H, DJ5H	132
	2.000 - 6.000	.61	ROUGH-AIR 0° Lead High-Speed Router Face Mill (Aluminum)	5X6W	133
	2.000 - 6.000	.82	ROUGH-AIR 0° Lead Double Positive High-Speed Router Face Mill	5X6X	134
	2.500 - 6.000	.99	ROUGH-AIR 0° Lead High-Speed Router Face Mill (Aluminum)	5X6Z	136
	1.500 - 3.000	.31	EVO-TEC MINI 0° Lead Face Mill	SJ_Y	138
	2.000 - 5.000	.42	EVO-TEC 0° Lead Face Mill	SJ6F, SJ5F	140

0° FACE MILLS.

	Diameter	Cut Depth	Description	Series	Page
	3.000 - 4.000	.54	EVO•TEC 0° Lead Face Mill	SJ5J, SJ6J	142
	5.000 - 8.000	.54	EVO•TEC 0° Lead Face Mill	SJ2J	144
	3.000 - 12.000	.68	S•MAX 0° Lead Face Mill	SJ6N	146
	4.000 - 12.000	.68	S•MAX 0° Lead Heavy Duty Face Mill	SJ2N	148
	6.000 - 12.000	.35	S•MAX 0° Lead Heavy Duty Face Mill	SJ2R	150
	2.000 - 6.000	.46	V•MAX 0° Lead Hi-Density Face Mill	VK5V (High Density)	152
	2.000 - 6.000	.46	V•MAX 0° Lead Medium - Density Face Mill	VK6V (Medium Density)	154
	2.000 - 6.000	.46	V•MAX 0° Lead Coarse-Density Face Mill	VK6V (Coarse-Density)	156
	2.500 - 12.000	.46	V•MAX 3° Lead Face Mill	VL6V	158
	3.000 - 8.000	.008	S•MAX Finishing Face Mill	SF6H, SF6N	159

0 DEGREE LEAD FACE MILL

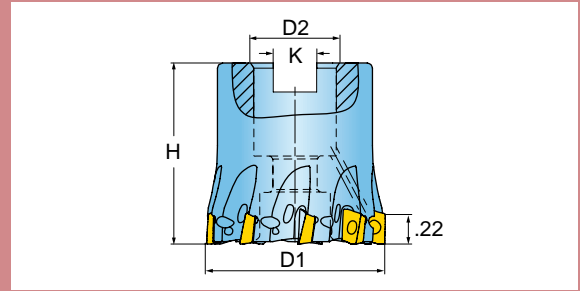

Cutter Number	D1 Effective Diameter	Number of Inserts	H Height	D2 Bore Dia.	K Keyway	Ramp Angle
2J1D-15R01	1.500	9	1.570	0.500	0.250	1.3
2J1D-20R10	2.000	9	1.547	0.750	0.312	.9

Operating guidelines on [page 358](#).

INSERTS

AOCT060204FR-P 	AOMT060202R 	AOMT060204R
AOMT060208R 	AOMT060216R 	UOMT0602TR

Part Number	Applications	Grade					
		IN05S	IN1030	IN2005	IN2030	IN2505	
AOCT060204FR-P	Grd/Pol for Al - 0.015" R	●					
AOMT060202R	Multi-Purpose - 0.008" R		●	●	●		
AOMT060204R	Multi-Purpose - 0.015" R			●	●	●	
AOMT060208R	Multi-Purpose - 0.031" R			●	●	●	
AOMT060216R	Multi-Purpose - 0.062" R			●	●		
UOMT0602TR	High-Feed - 0.040" R*				●	●	

* Program Radius

● = P ● = M ● = K ● = N ● = S

HARDWARE

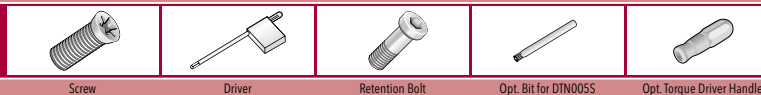

2J1D-15R01	SM18-041-00	DS-TP06S	SD-04-85	DS-TP06TB	DTN005S
2J1D-20R10	SM18-041-00	DS-TP06S	SD-06-46	DS-TP06TB	DTN005S

0 DEGREE LEAD FACE MILL



Shoulder

Channel

Corkscrew

Pocket

Facing

Coolant

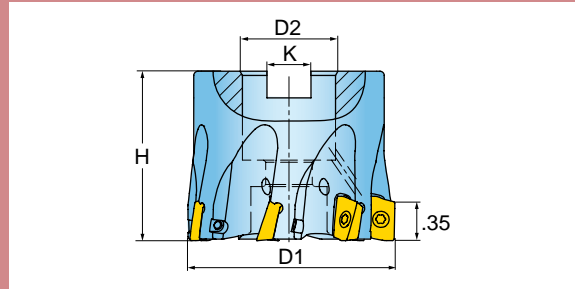

Cutter Number	D1 Effective Diameter	Number of Inserts	H Height	D2 Bore Dia.	K Keyway	Ramp Angle
2J1P-15R01	1.500	6	1.570	0.500	0.250	2.4
2J1P-20R01	2.000	7	1.570	0.750	0.312	1.3
2J1P-30R01	3.000	9	1.750	1.000	0.375	1.0

Operating guidelines on [page 349](#).

INSERTS

BOCT09T304FR-P

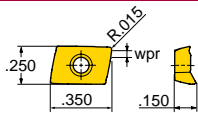

BOCT09T308FR-P

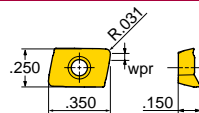

BOMT09T304R

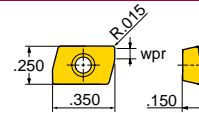

BOMT09T308R

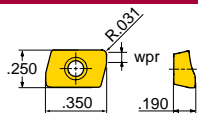

BOMT09T316R

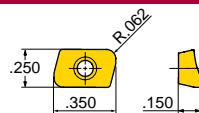

Part Number	Applications	Grade												
			IN10K	IN2030	IN2505	IN2505								
BOCT09T304FR-P	Grd/Pol for Al - 0.015" R		●											
BOCT09T308FR-P	Grd/Pol for Al - 0.031" R		●											
BOMT09T304R	Multi-Purpose - 0.015" R			●	●									
BOMT09T308R	Multi-Purpose - 0.031" R			●	●									
BOMT09T316R	Multi-Purpose - 0.062" R			●	●									

● = P ● = M ● = K ● = N ● = S

HARDWARE

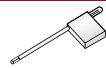

Screw

Driver

Retention Bolt

(Optional) Coolant Bolt

2J1P-15R01	SM25-064-00	DS-T08W	SD-04-85	-
2J1P-20R01	SM25-064-00	DS-T08W	SD-06-46	SD-06-89
2J1P-30R01	SM25-064-00	DS-T08W	SD-08-48	SD-08-92



HIPOST[™] SERIES 2J1X

0 DEGREE LEAD FACE MILL

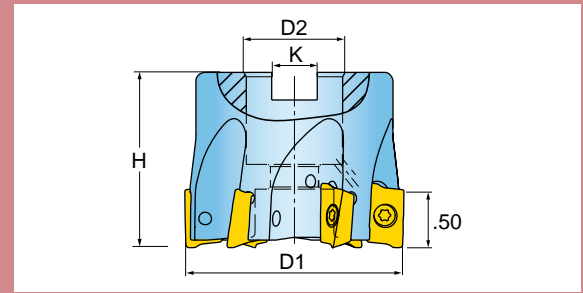

Cutter Number	D1 Nominal Diameter	Number of Inserts	H Height	D2 Bore Dia.	K Keyway	Ramp Angle	Coolant
2J1X-15R01	1.500	4	1.570	0.500	0.250	3.7	No
2J1X-20R01	2.000	3	1.570	0.750	0.312	2.8	Yes
2J1X-20R02	2.000	6	1.570	0.750	0.312	2.8	Yes
2J1X-25R01	2.500	5	1.570	0.750	0.312	2.1	Yes
2J1X-30R01	3.000	8	1.750	1.000	0.375	1.6	Yes
2J1X-40R01	4.000	8	1.750	1.500	0.625	1.0	Yes

Cutter body to be relieved to accept radius over R. 125
 Operating guidelines on [page 359](#).

HIPOST[™] SERIES 2L1X

15 DEGREE LEAD FACE MILL

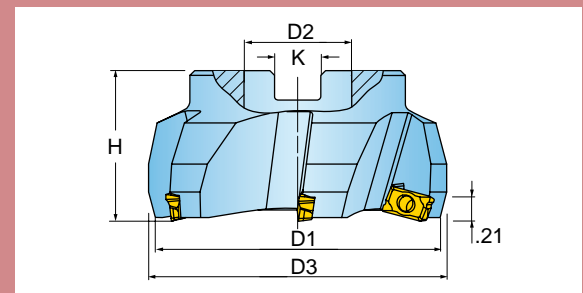
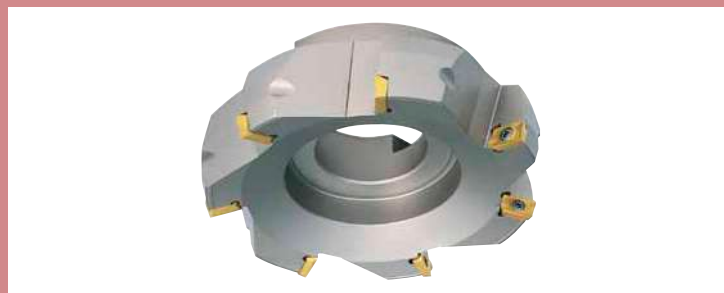

Cutter Number	D1 Nominal Diameter	Number of Inserts	H Height	D2 Bore Dia.	D3 Overall Dia.	K Keyway
2L1X-30R01	3.000	5	1.750	1.000	3.20	0.375

Operating guidelines on [page 359](#).

INSERTS

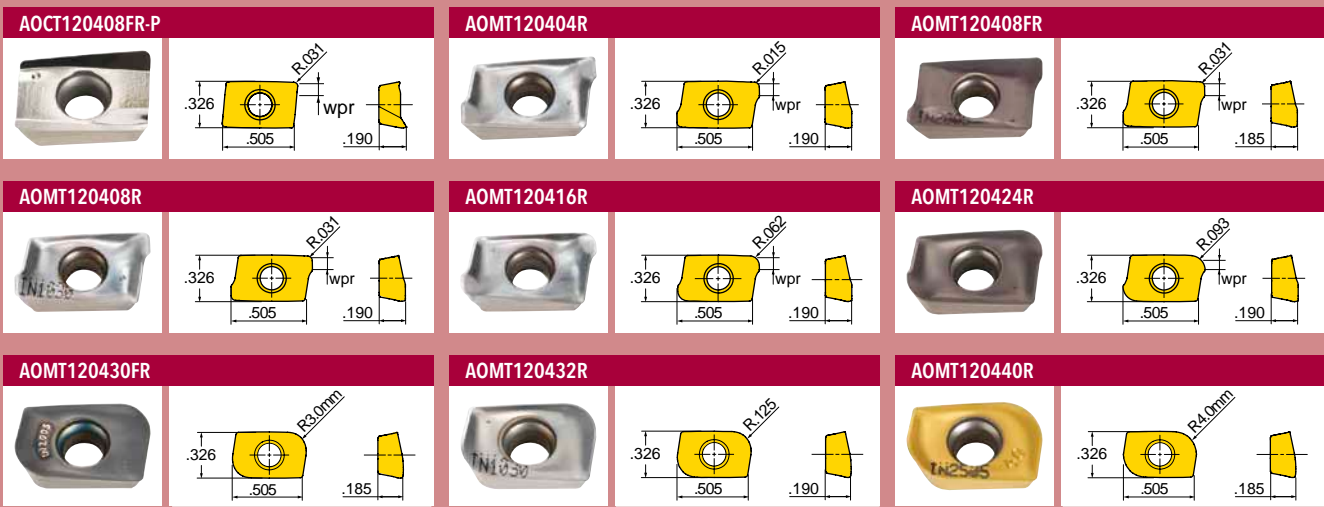

Part Number	Applications	Grade							
		IN1030	IN10K	IN2005	IN2010	IN2030	IN2040	IN2505	IN2510
AOCT120408FR-P	Grd/Pol for Al - 0.031" R		●						
AOMT120404R	Multi-Purpose - 0.015" R	●		●					
AOMT120408FR	Hi-Temp/Ti - 0.031" R			●		●			
AOMT120408R	Multi-Purpose - 0.031" R	●		●	●	●	●	●	
AOMT120416R	Multi-Purpose - 0.062" R	●		●		●			●
AOMT120424R	Multi-Purpose - 0.093" R			●		●			
AOMT120430FR	Multi-Purpose - 3.000 mm R			●					
AOMT120432R	Multi-Purpose - 0.125" R	●		●	●	●	●		
AOMT120440R*	Multi-Purpose - 4.000 mm R							●	

* Cutter to be relieved to accept 4mm R.

● = P ● = M ● = K ● = N ● = S

HARDWARE



	Screw	Driver	Retention Bolt	(Optional) Coolant Bolt
2J1X-15R01	SM35-088-10	DS-T10T	-	-
2J1X-20R01	SM35-088-10	DS-T10T	SD-06-46	SD-06-89
2J1X-20R02	SM35-088-10	DS-T10T	SD-06-46	SD-06-89
2J1X-25R01	SM35-088-10	DS-T10T	SD-06-46	SD-06-89
2J1X-30R01	SM35-088-10	DS-T10T	SD-08-47	SD-08-92
2L1X-30R01	SM35-088-10	DS-T10T	SD-08-47	SD-08-92
2J1X-40R01	SM35-088-10	DS-T10T	-	-



0 DEGREE LEAD FACE MILL

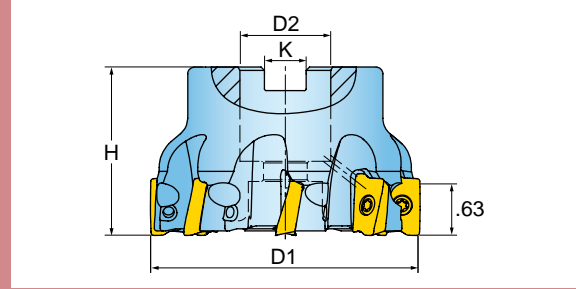

Cutter Number	D1 Nominal Diameter	Number of Inserts	H Height	D2 Bore Dia.	K Keyway	Bolt Circle Diameter	Ramp Angle
2J1G-20R01	2.000	5	1.570	0.750	0.312	NA	4.4
2J1G-20R02	2.000	3	1.570	0.750	0.312	NA	4.4
2J1G-25R01	2.500	6	1.570	0.750	0.312	NA	3.2
2J1G-30R01	3.000	7	1.750	1.000	0.375	NA	2.3
2J1G-30R02	3.000	4	1.750	1.000	0.375	NA	2.3
2J1G-40R01	4.000	8	2.000	1.500	0.625	NA	1.8
2J1G-40R02	4.000	6	2.000	1.500	0.625	NA	1.8
2J1G-50R01	5.000	9	2.000	1.500	0.625	NA	1.4
2J1G-60R01	6.000	10	2.000	2.000	0.750	NA	.7
2J1G-60R02	6.000	8	2.000	2.000	0.750	NA	.7
2J1G-80R01	8.000	12	2.000	2.500	1.000	4.00	

Operating guidelines on [page 359](#).

INSERTS

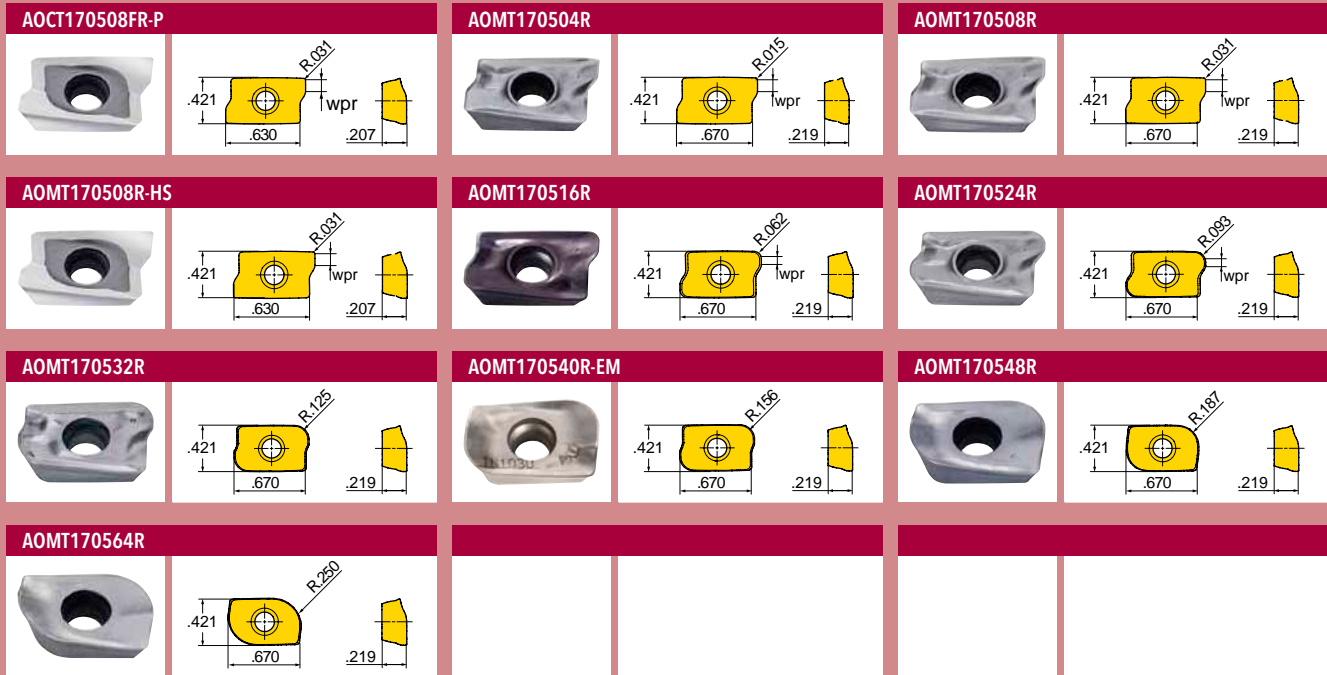

Part Number	Applications	Grade	IN1030	IN2005	IN2010	IN2030	IN2040	IN2505	IN2510	INDD15	IN10K
AOCT170508FR-P	Grd/Pol for Al - 0.031" R										
AOMT170504R	Multi-Purpose - 0.015" R										
AOMT170508R	Multi-Purpose - 0.031" R										
AOMT170508R-HS	Hi-Temp/Ti - 0.031" R										
AOMT170516R	Multi-Purpose - 0.062" R										
AOMT170524R	Multi-Purpose - 0.093" R										
AOMT170532R	Multi-Purpose - 0.125" R										
AOMT170540R-EM*	Multi-Purpose - 0.156" R										
AOMT170548R*	Multi-Purpose - 0.187" R										
AOMT170564R*	Multi-Purpose - 0.250" R										

*Body must be relieved to accept radii over .125" R.

= P = M = K = N = S

Hardware				
	Screw	Driver	Retention Bolt	(Optional) Coolant Bolt
2J1G-20R01	SM40-120-20	DS-T15T	SD-06-46	SD-06-89
2J1G-20R02	SM40-120-20	DS-T15T	SD-06-46	SD-06-89
2J1G-25R01	SM40-120-20	DS-T15T	SD-06-46	SD-06-89
2J1G-30R01	SM40-120-20	DS-T15T	SD-08-47	SD-08-92
2J1G-30R02	SM40-120-20	DS-T15T	SD-08-47	SD-08-92
2J1G-40R01	SM40-120-20	DS-T15T	-	-
2J1G-40R02	SM40-120-20	DS-T15T	-	-
2J1G-50R01	SM40-120-20	DS-T15T	-	-
2J1G-60R01	SM40-120-20	DS-T15T	-	-
2J1G-60R02	SM40-120-20	DS-T15T	-	-
2J1G-80R01	SM40-120-20	DS-T15T	-	-



HIPOST⁺ SERIES 2J1E, 2J4E

0 DEGREE FACE MILL

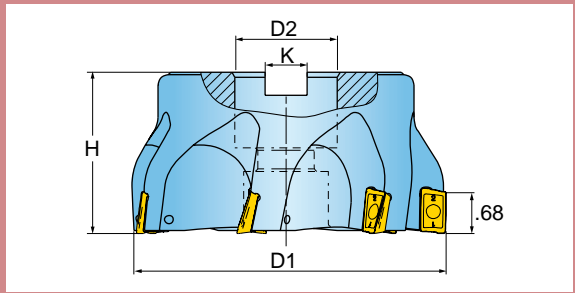

Cutter Number	D1 Nominal Diameter	Number of Inserts	H Height	D2 Bore Dia.	K Keyway	Bolt Circle Diameter	Accepts Insert Radius	Ramp Angle
2J1E-20R01	2.000	3	1.570	0.750	0.312	NA	.015 - .125	3
2J1E-20R02	2.000	5	1.570	0.750	0.312	NA	.015 - .125	3
2J4E-20R02**	2.000	5	1.570	0.750	0.312	NA	.187 - .250	3
2J1E-25R01	2.500	4	1.570	0.750	0.312	NA	.015 - .125	2.6
2J1E-25R02	2.500	6	1.570	0.750	0.312	NA	.015 - .125	2.6
2J1E-30R01	3.000	5	1.750	1.000	0.375	NA	.015 - .125	1.8
2J1E-30R02	3.000	7	1.750	1.000	0.375	NA	.015 - .125	1.8
2J1E-30R03	3.000	4	1.750	1.000	0.375	NA	.015 - .125	1.8
2J4E-30R02**	3.000	7	1.750	1.000	0.375	NA	.187 - .250	1.8
2J1E-40R01	4.000	6	2.000	1.500	0.625	NA	.015 - .125	1.2
2J1E-40R02	4.000	8	2.000	1.500	0.625	NA	.015 - .125	1.2
2J4E-40R02**	4.000	8	2.000	1.500	0.625	NA	.187 - .250	1.2
2J1E-50R01	5.000	7	2.000	1.500	0.625	NA	.015 - .125	.9
2J1E-50R02	5.000	9	2.000	1.500	0.625	NA	.015 - .125	.9
2J1E-60R01	6.000	8	2.000	2.000	0.750	NA	.015 - .125	.6
2J1E-60R02	6.000	10	2.000	2.000	0.750	NA	.015 - .125	.6
2J1E-80R01	8.000	10	2.480	2.500	1.000	4.00	.015 - .125	
2J1E-80R02	8.000	12	2.480	2.500	1.000	4.00	.015 - .125	

**Cutter utilizes larger radius inserts > .125" R Operating guidelines on [page 358](#).

HARDWARE				
	Screw	Driver	Retention Bolt	(Optional) Coolant Bolt

2J1E-20R01	SM40-120-20	DS-T15T	SD-06-46	SD-06-89
2J1E-20R02	SM40-093-20	DS-T15T	SD-06-46	SD-06-89
2J4E-20R02	SM40-120-20	DS-T15T	SD-06-46	SD-06-89
2J1E-25R01	SM40-120-20	DS-T15T	SD-06-46	SD-06-89
2J1E-25R02	SM40-120-20	DS-T15T	SD-06-46	SD-06-89
2J1E-30R01	SM40-120-20	DS-T15T	SD-08-46	SD-08-92
2J1E-30R02	SM40-120-20	DS-T15T	SD-08-46	SD-08-92
2J1E-30R03	SM40-120-20	DS-T15T	SD-08-46	SD-08-92
2J4E-30R02	SM40-120-20	DS-T15T	SD-08-46	SD-08-92
2J1E-40R01	SM40-120-20	DS-T15T	-	-
2J1E-40R02	SM40-120-20	DS-T15T	-	-
2J4E-40R02	SM40-120-20	DS-T15T	-	-
2J1E-50R01	SM40-120-20	DS-T15T	-	-
2J1E-50R02	SM40-120-20	DS-T15T	-	-
2J1E-60R01	SM40-120-20	DS-T15T	-	-
2J1E-60R02	SM40-120-20	DS-T15T	-	-
2J1E-80R01	SM40-120-20	DS-T15T	-	-
2J1E-80R02	SM40-120-20	DS-T15T	-	-

INSERTS



Part Number	Applications	Grade	IN05S	IN1030	IN2005	IN2015	IN2030	IN2040	IN30M		
AOMT180504FR-P	Grd/Pol for Al - 0.015" R		●								
AOMT180504R-HS	Hi-Temp/Ti - 0.015" R						●				
AOMT180508FR-P	Grd/Pol for Al - 0.031" R									●	
AOMT180508R	Multi-Purpose - 0.031" R			●	●	●	●	●			
AOMT180508R-HS	Hi-Temp/Ti - 0.031" R				●		●			●	
AOMT180516FR-P	Grd/Pol for Al - 0.062" R									●	
AOMT180516R	Multi-Purpose - 0.062" R			●	●	●	●	●			
AOMT180516R-HS	Hi-Temp/Ti - 0.062" R				●						
AOMT180524FR-P	Grd/Pol for Al - 0.093" R									●	
AOMT180524R	Multi-Purpose - 0.093" R			●	●			●			
AOMT180532FR-P	Grd/Pol for Al - 0.125" R									●	
AOMT180532R	Multi-Purpose - 0.125" R			●	●	●	●	●			
AOMT180548R*	Multi-Purpose - 0.187" R				●						
AOMT180564R*	Multi-Purpose - 0.250" R			●	●			●			

* Use in 2J4E Bodies

● = P ● = M ● = K ● = N ● = S



15 DEGREE LEAD FACE MILL



Facing

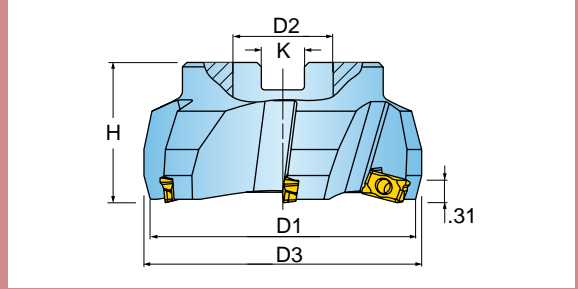
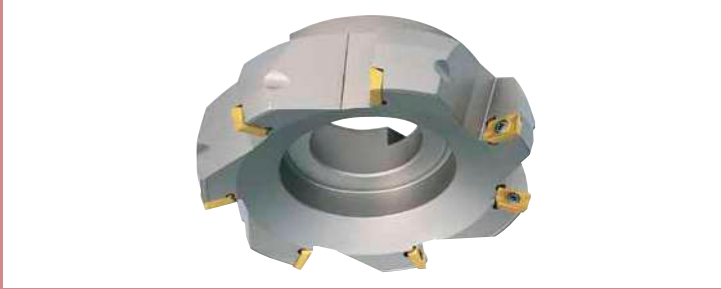

Cutter Number	D1 Nominal Diameter	Number of Inserts	H Height	D2 Bore Dia.	D3 Overall Diameter	K Keyway
2L1E-25R01	2.500	4	1.570	0.750	2.70	0.312
2L1E-40R01	4.000	6	2.000	1.500	4.20	0.625

Operating guidelines on [page 358](#).

INSERTS

AOMT180504FR-P

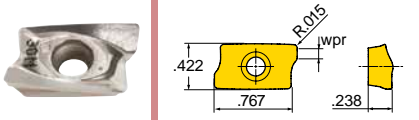

AOMT180504R-HS

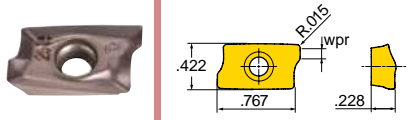

AOMT180508FR-P

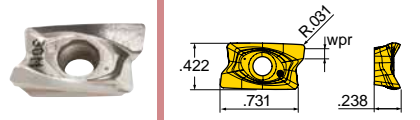

AOMT180508R

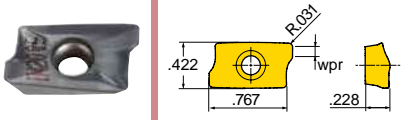

AOMT180508R-HS

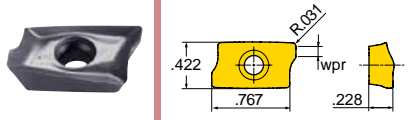

AOMT180516FR-P

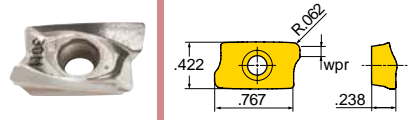

AOMT180516R

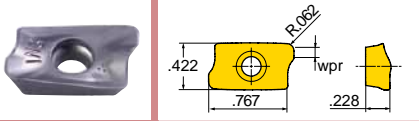

AOMT180516R-HS

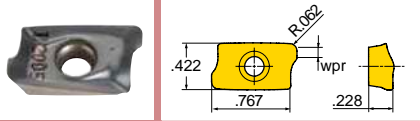

AOMT180524FR-P

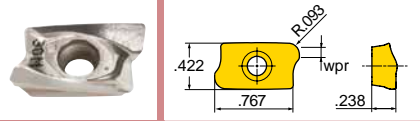

AOMT180524R

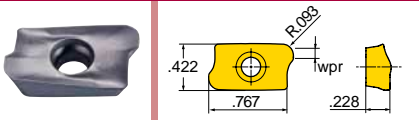

AOMT180532FR-P

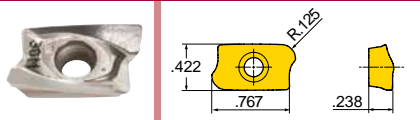

AOMT180532R

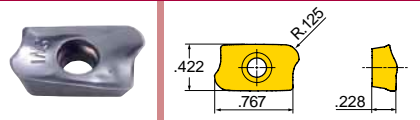

Part Number	Applications	Grade	IN05S	IN1030	IN2005	IN2015	IN2030	IN2040	IN30M		
AOMT180504FR-P	Grd/Pol for Al - 0.015" R		●								
AOMT180504R-HS	Hi-Temp/Ti - 0.015" R						●				
AOMT180508FR-P	Grd/Pol for Al - 0.031" R								●		
AOMT180508R	Multi-Purpose - 0.031" R			●	●	●	●	●			
AOMT180508R-HS	Hi-Temp/Ti - 0.031" R				●		●		●		
AOMT180516FR-P	Grd/Pol for Al - 0.062" R								●		
AOMT180516R	Multi-Purpose - 0.062" R			●	●	●	●	●			
AOMT180516R-HS	Hi-Temp/Ti - 0.062" R				●						
AOMT180524FR-P	Grd/Pol for Al - 0.093" R								●		
AOMT180524R	Multi-Purpose - 0.093" R			●	●			●			
AOMT180532FR-P	Grd/Pol for Al - 0.125" R								●		
AOMT180532R	Multi-Purpose - 0.125" R			●	●	●	●	●			

● = P ● = M ● = K ● = N ● = S

HARDWARE



Screw



Driver



Retention Bolt

SM40-120-20

DS-T15T

SD-06-46



TETRA™ SERIES TJ6N

0 DEGREE FACE MILL WITH 4 INDEXES

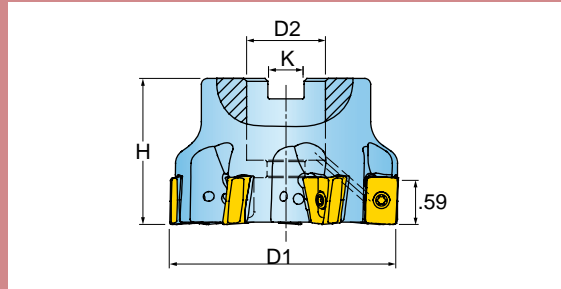

Cutter Number	D1 Nominal Diameter	Number of Inserts	H Height	D2 Bore Dia.	K Keyway	Bolt Circle Diameter	Ramp Angle
TJ5N-20R01	2.000	4	1.570	0.750	0.312	NA	1.0
TJ6N-20R01	2.000	3	1.570	0.750	0.312	NA	1.0
TJ5N-25R01	2.500	5	1.750	1.000	0.375	NA	.6
TJ5N-30R01	3.000	7	1.750	1.000	0.375	NA	.5
TJ6N-30R01	3.000	5	1.750	1.000	0.375	NA	.5
TJ5N-40R01	4.000	8	2.000	1.500	0.625	NA	.35
TJ6N-40R01	4.000	5	2.000	1.500	0.625	NA	.35
TJ5N-50R01	5.000	10	2.000	1.500	0.625	NA	.25
TJ6N-50R01	5.000	7	2.000	1.500	0.625	NA	.25
TJ5N-60R01	6.000	11	2.480	1.500	0.625	NA	.15
TJ6N-60R01	6.000	8	2.480	1.500	0.625	NA	.15
TJ5N-80R01	8.000	14	2.480	2.500	1.000	4.00	.05

Operating guidelines on [page 353](#).

INSERTS

ANHU160704FR-P

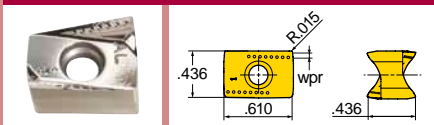

ANHU160704R

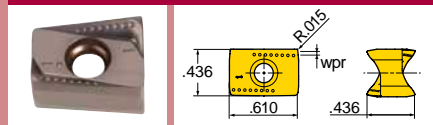

ANHU160708FR

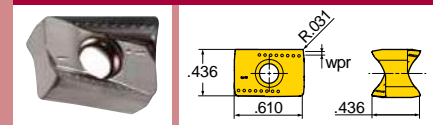

ANHU160708FR-P

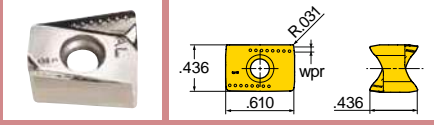

ANHU160708R

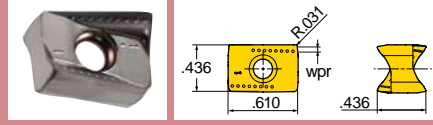

ANHU160716R

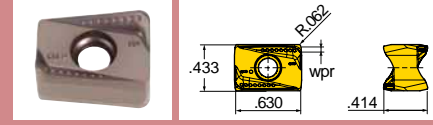

Part Number	Applications	Grade	IN10K	IN2010	IN2030	IN2505	IN2540	INDD15			
ANHU160704FR-P	Grd/Pol for Al - 0.015" R		●								
ANHU160704R	Multi-Purpose - 0.015" R				●						
ANHU160708FR	Hi-Temp/Ti - 0.031" R				●						
ANHU160708FR-P	Grd/Pol for Al - 0.031" R		●								
ANHU160708R	Multi-Purpose - 0.031" R			●	●	●	●	●			
ANHU160716R	Multi-Purpose - 0.062" R			●	●	●	●				

● = P ● = M ● = K ● = N ● = S

HARDWARE



	Screw	Driver	Retention Bolt	(Optional) Coolant Bolt
TJ5N-20R01	SM40-120-20	DS-T15T	SD-06-46	SD-06-89
TJ6N-20R01	SM40-120-20	DS-T15T	SD-06-46	SD-06-89
TJ5N-25R01	SM40-120-20	DS-T15T	SD-08-46	SD-08-92
TJ5N-30R01	SM40-120-20	DS-T15T	-	-
TJ6N-30R01	SM40-120-20	DS-T15T	-	-
TJ5N-40R01	SM40-120-20	DS-T15T	-	-
TJ6N-40R01	SM40-120-20	DS-T15T	-	-
TJ5N-50R01	SM40-120-20	DS-T15T	-	-
TJ6N-50R01	SM40-120-20	DS-T15T	-	-
TJ5N-60R01	SM40-120-20	DS-T15T	-	-
TJ6N-60R01	SM40-120-20	DS-T15T	-	-
TJ5N-80R01	SM40-120-20	DS-T15T	-	-



HIPOPOSQUAD™ SERIES 5J1E

0 DEGREE LEAD FACE MILL

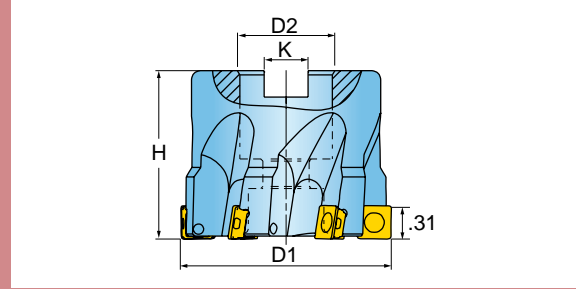

Cutter Number	D1 Effective Diameter	Number of Inserts	H Height	D2 Bore Dia.	K Keyway	Ramp Angle
5J1E-15R01	1.500	5	1.570	0.500	0.250	1.5
5J1E-20R01	2.000	6	1.570	0.750	0.312	1.2
5J1E-25R01	2.500	5	1.570	0.750	0.312	1.0
5J1E-25R02	2.500	7	1.570	0.750	0.312	1.0
5J1E-30R01	3.000	7	1.750	1.000	0.375	.5
5J1E-30R02	3.000	9	1.750	1.000	0.375	.5

Operating guidelines on [page 359](#).

INSERTS

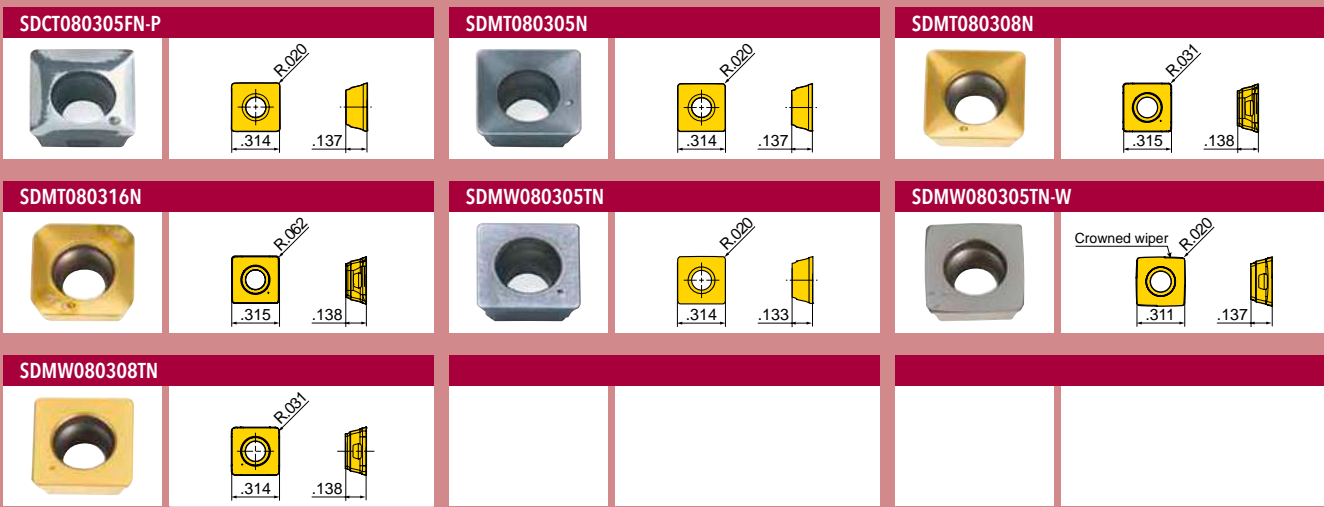

Part Number	Applications	Grade	IN1030	IN1530	IN2005	IN2015	IN2030	IN2040	IN30M		
			SDCT080305FN-P	Grd/Pol for Al - 0.020" R							
SDMT080305N	Multi-Purpose - 0.020" R		●		●	●	●	●			
SDMT080308N	Multi-Purpose - 0.031" R			●							
SDMT080316N	Multi-Purpose - 0.062" R			●							
SDMW080305TN	Heavy-Duty - 0.020" R		●		●	●	●				
SDMW080305TN-W*	Crowned Wiper - 0.020" R				●	●					
SDMW080308TN	Heavy-Duty - 0.031" R			●							

*When used, wiper inserts should be loaded in all stations.

● = P ● = M ● = K ● = N ● = S

HARDWARE

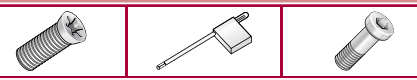

	Screw	Driver	Retention Bolt
5J1E-15R01	SM30-065-00	DS-T09W	SD-04-85
5J1E-20R01	SM30-065-00	DS-T09W	SD-06-46
5J1E-25R01	SM30-065-00	DS-T09W	SD-06-46
5J1E-25R02	SM30-065-00	DS-T09W	SD-06-46
5J1E-30R01	SM30-065-00	DS-T09W	SD-08-47
5J1E-30R02	SM30-065-00	DS-T09W	SD-08-47



ALUMINATOR SERIES 5H6G

0 DEGREE LEAD HIGH-SPEED ROUTER FACE MILL (ALUMINUM)

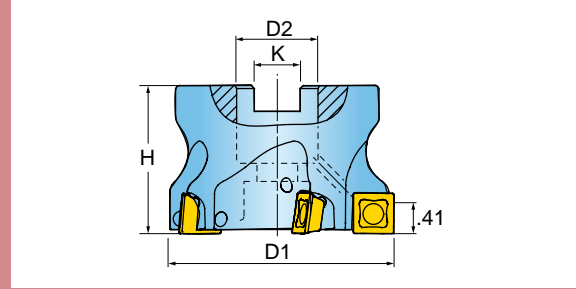

Cutter Number	D1 Nominal Diameter	Number of Inserts	H Height	D2 Bore Dia.	K Keyway	Ramp Angle
5H6G-20R01	2.000	5	1.570	0.750	0.312	2.0
5H6G-20R02	2.000	3	1.570	0.750	0.312	2.0
5H6G-25R01	2.500	4	1.750	1.000	0.375	1.0
5H6G-30R01	3.000	8	1.750	1.000	0.375	0.5
5H6G-30R02	3.000	3	1.750	1.000	0.375	0.5
5H6G-40R01	4.000	9	2.375	1.500	0.625	0.5
5H6G-40R02	4.000	5	2.375	1.500	0.625	0.5
5H6G-60R02	6.000	7	2.375	1.500	0.625	NA

Operating guidelines on [page 363](#).

INSERTS

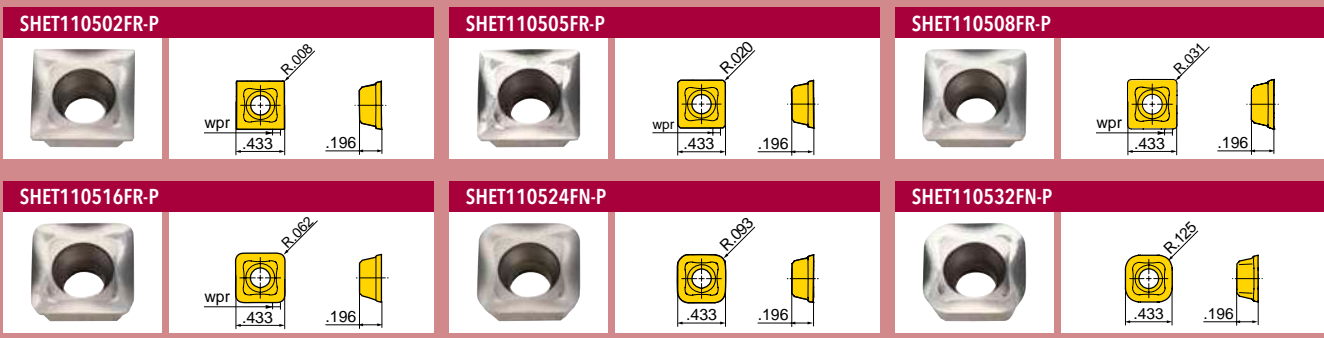

Part Number	Applications	Grade	IN15K								
SHET110502FR-P	Grd/Pol for Al - 0.008" R		●								
SHET110505FR-P	Grd/Pol for Al - 0.020" R		●								
SHET110508FR-P	Grd/Pol for Al - 0.031" R		●								
SHET110516FR-P	Grd/Pol for Al - 0.062" R		●								
SHET110524FN-P	Grd/Pol for Al - 0.093" R		●								
SHET110532FN-P	Grd/Pol for Al - 0.125" R		●								

● = P ● = M ● = K ● = N ● = S

HARDWARE



	Screw	Driver	Retention Bolt	(Optional) Coolant Bolt
5H6G-20R01	SM40-093-20	DS-T15T	SD-06-46	SD-06-89
5H6G-20R02	SM40-093-20	DS-T15T	SD-06-46	SD-06-89
5H6G-25R01	SM40-093-20	DS-T15T	SD-08-46	SD-08-92
5H6G-30R01	SM40-093-20	DS-T15T	SD-08-46	SD-08-92
5H6G-30R02	SM40-093-20	DS-T15T	SD-08-46	SD-08-92
5H6G-40R01	SM40-093-20	DS-T15T	SD-12-82	SD-12-99
5H6G-40R02	SM40-093-20	DS-T15T	SD-12-82	SD-12-99
5H6G-60R02	SM40-093-20	DS-T15T	SD-12-82	SD-12-99

0 DEGREE LEAD FACE MILL

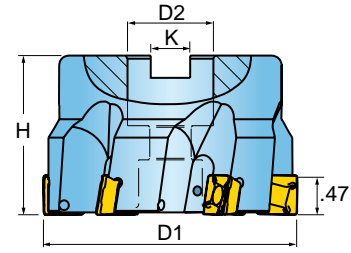

Cutter Number	D1 Effective Diameter	Number of Inserts	H Height	D2 Bore Dia.	K Keyway
5J1H-20R01	2.000	5	1.570	0.750	0.312
5J1H-30R01	3.000	7	1.750	1.000	0.375
5J1H-40R01	4.000	8	2.000	1.500	0.625

Operating guidelines on [page 360](#).

INSERTS

SDMT120608R

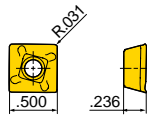

SDMT120608R-HS

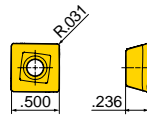

Part Number	Applications	Grade								
			IN1030	IN2005	IN2015	IN2030	IN5015			
SDMT120608R	Multi-Purpose - 0.031" R									
SDMT120608R-HS	Hi-Temp/Ti - 0.031" R									

● = P
 ● = M
 ● = K
 ● = N
 ● = S

HARDWARE



Screw

Driver

Retention Bolt

(Optional) Coolant Bolt

5J1H-20R01	SM40-120-20	DS-T15T	SD-06-46	SD-06-89
5J1H-30R01	SM40-120-20	DS-T15T	SD-08-47	SD-08-92
5J1H-40R01	SM40-120-20	DS-T15T	-	-

0 DEGREE LEAD SINI FACE MILL



Shoulder



Corkscrew



Facing



Balanced

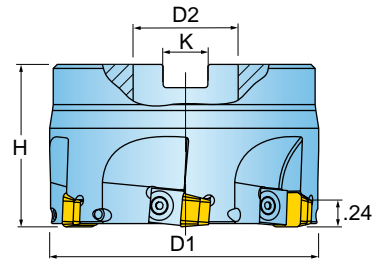

Cutter Number	D1 Nominal Diameter	Number of Inserts	H Height	D2 Bore Dia.	K Keyway
5J2H-20R01	2.000	3	2.380	0.750	0.312
5J2H-30R01	3.000	5	2.380	1.000	0.375
5J2H-40R01	4.000	6	2.380	1.500	0.625
5J2H-50R01	5.000	7	2.380	2.000	0.750
5J2H-60R01	6.000	8	2.380	2.000	0.750

Operating guidelines on [page 361](#).

INSERTS

OPEN050608TR

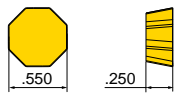
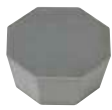

SPEN120608TN

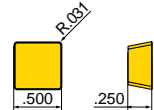

SPEN120611TR-W

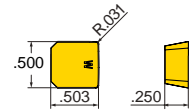

SPEN1206MPTN

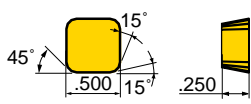

SPEN1206MPTR-W

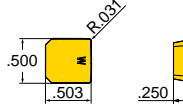

Part Number	Applications	Grade							
			IN70N	IN72N					
OPEN050608TR	Multi-Purpose - 0.031" R			●					
SPEN120608TN	Multi-Purpose - 0.031" R		●						
SPEN120611TR-W	Crowned Wiper - 0.031" R		●						
SPEN1206MPTN	Multi-Purpose - 0.096" Faceted		●						
SPEN1206MPTR-W	Crowned Wiper - 0.096" Faceted		●						

● = P ● = M ● = K ● = N ● = S

HARDWARE



Screw



Wedge



Retention Bolt



Insert Seat



Differential Screw



Allen Wrench

5J2H-20R01	SM30-065-00	2H-422-01	SD-06-99	-	SB-04-13	WS-0022
5J2H-30R01	SM30-065-00	2H-422-01	SD-08-48	PA-0575	SB-04-13	WS-0022
5J2H-40R01	SM30-065-00	2H-422-01	SD-12-82	PA-0575	SB-04-13	WS-0022
5J2H-50R01	SM30-065-00	2H-422-01	-	PA-0575	SB-04-13	WS-0022
5J2H-60R01	SM30-065-00	2H-422-01	-	PA-0575	SB-04-13	WS-0022



0 DEGREE LEAD ADJUSTABLE FINISHING FACE MILL
WITH UP TO 8 INDEXES

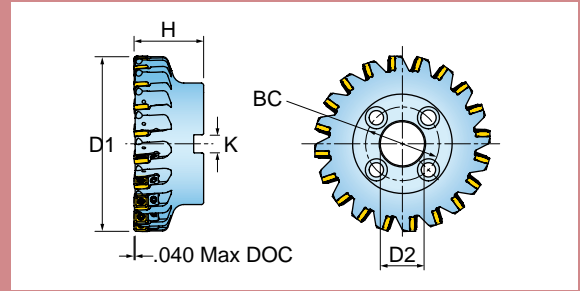

Cutter Number	D1 Nominal Diameter	Number of Inserts	H Height	D2 Bore Dia.	K Keyway	Bolt Circle Diameter
DJ1H-20R01	2.000	3	1.750	0.750	0.312	NA
DJ1H-30R01	3.000	4	1.750	1.000	0.375	NA
DJ1H100R00	100mm	12	63mm	32mm	14mm	NA
DJ1H-40R01	4.000	12	2.482	1.250	0.500	NA
DJ1H-40R02	4.000	6	2.482	1.250	0.500	NA
DJ1H125R00	125mm	16	63mm	40mm	16mm	NA
DJ1H-60R01	6.000	20	2.482	1.500	0.625	NA
DJ1H-60R02	6.000	8	2.482	1.500	0.625	NA
DJ1H-80R01	8.000	24	2.482	2.500	1.000	4.00
DJ1H-80R02	8.000	12	2.482	2.500	1.000	4.00

Operating guidelines on [page 367](#).

INSERTS

SNED120420

SNED1204ANR-DT

SNES1204ANN

SNEV1204ANN-PH



Part Number	Applications	Grade	IN2010	IN2505	IN80B							
-------------	--------------	-------	--------	--------	-------	--	--	--	--	--	--	--

SNED120420	Crowned Wiper - 0.078" R		●									
SNED1204ANR-DT	CBN - Hardened Steel/Cast Iron - 0.040" Chamfer				●							
SNES1204ANN	Crowned Wiper - 0.080" Chamfer		●									
SNEV1204ANN-PH	Crowned Wiper - 0.080" Chamfer			●								

● = P ● = M ● = K ● = N ● = S

HARDWARE

	Insert Screw	Driver	Retention Bolt	Adjusting Screw	Adjusting Wedge
DJ1H-20R01	SM35-110-R0	DS-T15T	SD-06-46	SB060-03	2E-831-01
DJ1H-30R01	SM35-110-R0	DS-T15T	SD-08-47	SB060-03	2E-831-01
DJ1H100R00	SM35-110-R0	DS-T15T	SD-10-89	SB060-03	2E-831-01
DJ1H-40R01	SM35-110-R0	DS-T15T	SD-10-47	SB060-03	2E-831-01
DJ1H-40R02	SM35-110-R0	DS-T15T	SD-10-47	SB060-03	2E-831-01
DJ1H125R00	SM35-110-R0	DS-T15T	-	SB060-03	2E-831-01
DJ1H-60R01	SM35-110-R0	DS-T15T	-	SB060-03	2E-831-01
DJ1H-60R02	SM35-110-R0	DS-T15T	-	SB060-03	2E-831-01
DJ1H-80R01	SM35-110-R0	DS-T15T	-	SB060-03	2E-831-01
DJ1H-80R02	SM35-110-R0	DS-T15T	-	SB060-03	2E-831-01



ISOPLUS SERIES DJ6T, DJ5T

0 DEGREE LEAD FACE MILL WITH 8 INDEXES

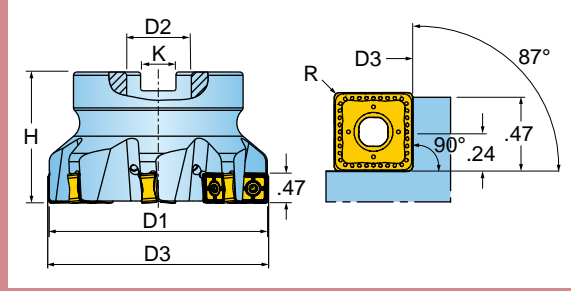

Cutter Number	D1 Nominal Diameter	D3 Overall Dia.	Number of Inserts	H Height	D2 Bore Dia.	K Keyway	Bolt Circle	Coolant
DJ6T-20R01	2.000	2.025	5	1.570	0.750	0.312	NA	Yes
DJ6T-25R01	2.500	2.523	6	1.570	0.750	0.312	NA	Yes
DJ5T-30R01	3.000	3.021	8	1.750	1.000	0.375	NA	Yes
DJ6T-30R01	3.000	3.021	7	1.750	1.000	0.375	NA	Yes
DJ5T-40R01	4.000	4.020	10	2.375	1.500	0.625	NA	Yes
DJ6T-40R01	4.000	4.020	8	2.375	1.500	0.625	NA	Yes
DJ5T-50R01	5.000	5.018	13	2.375	1.500	0.625	NA	Yes
DJ6T-50R01	5.000	5.018	10	2.375	1.500	0.625	NA	Yes
DJ5T-60R01	6.000	6.016	17	2.375	1.500	0.625	NA	No
DJ6T-60R01	6.000	6.018	12	2.375	1.500	0.625	NA	No
DJ5T-80R01	8.000	8.016	21	2.375	2.500	1.000	4.00	No
DJ6T-80R01	8.000	8.016	14	2.375	2.500	1.000	4.00	No

Operating guidelines on [page 364](#).

INSERTS

SNGU130604N

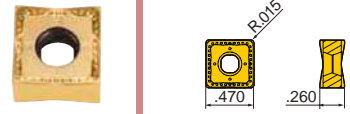

SNGU130608TN

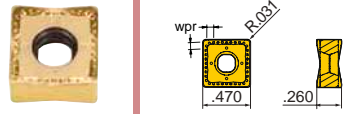

SNGU130616N

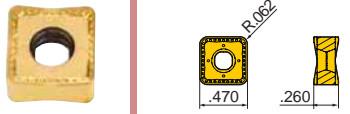

SNGU1306ANTN

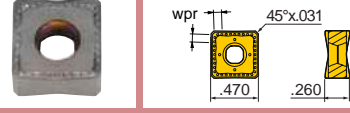

Part Number	Applications	Grade	IN2010	IN2030	IN2505	IN2540	INDD15				
-------------	--------------	-------	--------	--------	--------	--------	--------	--	--	--	--

SNGU130604N	Positive Geometry - 0.015" R		●	●	●						
SNGU130608TN	Positive Geometry - 0.031" R		●	●	●	●	●				
SNGU130616N	Positive Geometry - 0.062" R			●	●	●	●				
SNGU1306ANTN	Positive Geometry - 0.031" Chamfer 45 deg.		●				●				

● = P ● = M ● = K ● = N ● = S

HARDWARE



	Screw	Driver	Retention Bolt	(Optional) Coolant Bolt
DJ6T-20R01	SM40-100-R0	DS-T15T	SD-06-46	SD-06-89
DJ6T-25R01	SM40-100-R0	DS-T15T	SD-06-46	SD-06-89
DJ5T-30R01	SM40-100-R0	DS-T15T	SD-08-46	SD-08-92
DJ6T-30R01	SM40-100-R0	DS-T15T	SD-08-46	SD-08-92
DJ5T-40R01	SM40-100-R0	DS-T15T	SD-12-82	SD-12-99
DJ6T-40R01	SM40-100-R0	DS-T15T	SD-12-82	SD-12-99
DJ5T-50R01	SM40-100-R0	DS-T15T	SD-12-82	SD-12-99
DJ6T-50R01	SM40-100-R0	DS-T15T	SD-12-82	SD-12-99
DJ5T-60R01	SM40-100-R0	DS-T15T	-	-
DJ6T-60R01	SM40-100-R0	DS-T15T	-	-
DJ5T-80R01	SM40-100-R0	DS-T15T	-	-
DJ6T-80R01	SM40-100-R0	DS-T15T	-	-

ISOPLUS SERIES DJ6H, DJ5H

0 DEGREE FACE MILL WITH 6 INDEXES

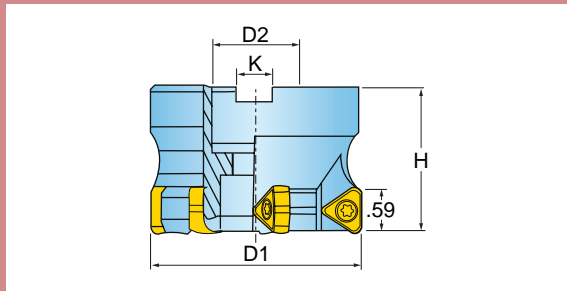

Cutter Number	D1 Nominal Diameter	Number of Inserts	H Height	D2 Bore Dia.	K Keyway
DJ5H-25R01	2.500	4	2.375	1.000	0.375
DJ6H-25R01	2.500	3	2.375	1.000	0.375
DJ5H-30R01	3.000	6	2.375	1.000	0.375
DJ6H-30R01	3.000	4	2.375	1.000	0.375
DJ5H-40R01	4.000	7	2.375	1.500	0.625
DJ6H-40R01	4.000	5	2.375	1.500	0.625
DJ5H-60R01	6.000	10	2.375	1.500	0.625
DJ6H-60R01	6.000	8	2.375	1.500	0.625

Operating guidelines on [page 364](#).

INSERTS

TNGU2207PNTN

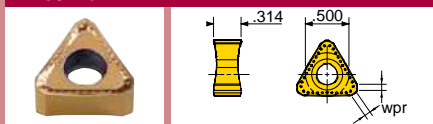

Part Number	Applications	Grade	IN2030	IN2505	IN2510						
-------------	--------------	-------	--------	--------	--------	--	--	--	--	--	--

TNGU2207PNTN Multi-Purpose - 0.093" R ● = P ● = M ● = K ● = N ● = S

HARDWARE



	Screw	Driver	Retention Bolt	(Optional) Coolant Bolt
DJ5H-25R01	SM45-120-R0	DS-T20T	SD-08-46	SD-08-92
DJ6H-25R01	SM45-120-R0	DS-T20T	SD-08-46	SD-08-92
DJ5H-30R01	SM45-120-R0	DS-T20T	SD-08-46	SD-08-92
DJ6H-30R01	SM45-120-R0	DS-T20T	SD-08-46	SD-08-92
DJ5H-40R01	SM45-120-R0	DS-T20T	-	-
DJ6H-40R01	SM45-120-R0	DS-T20T	-	-
DJ5H-60R01	SM45-120-R0	DS-T20T	-	-
DJ6H-60R01	SM45-120-R0	DS-T20T	-	-

0 DEGREE LEAD HIGH SPEED ROUTER FACE MILL (ALUMINUM)

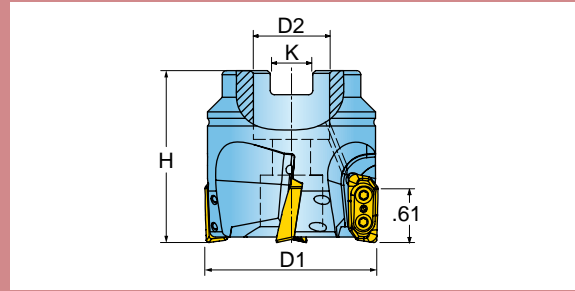

Cutter Number	D1 Nominal Diameter	D2 Bore Size	K Keyway	H Height	#Flutes Effective	Ramp Angle
5X6W-20R01	2.000	0.750	0.312	2.000	4	6.2
5X6W-25R01	2.500	1.000	0.375	2.000	4	4.7
5X6W-30R01	3.000	1.000	0.375	2.000	5	3.6
5X6W-40R01	4.000	1.500	0.625	2.375	5	2.8
5X6W-60R01	6.000	1.500	0.625	2.375	7	1.5

Prebalanced to: G6.3 @ 20,000 RPM
Operating guidelines on [page 363](#).

INSERTS

XPET140405FR-P 	XPET140408FR-P 	XPET140408FR-PW
XPET140416FR-P 	XPET140424FR-P 	XPET140432FR-P

Part Number	Applications	Grade	IN15K							
XPET140405FR-P	Grd/Pol for Al - 0.020" R		●							
XPET140408FR-P	Grd/Pol for Al - 0.031" R		●							
XPET140408FR-PW	Grd/Pol for Al - 0.031" Wiper w/Radius		●							
XPET140416FR-P	Grd/Pol for Al - 0.062" R		●							
XPET140424FR-P	Grd/Pol for Al - 0.093" R		●							
XPET140432FR-P	Grd/Pol for Al - 0.125" R		●							

● = P ● = M ● = K ● = N ● = S

HARDWARE



	Screw	Driver	Retention Bolt	(Optional) Coolant Bolt
5X6W-20R01	SM30-082-00	DS-T09W	SD-06-46	SD-06-89
5X6W-25R01	SM30-082-00	DS-T09W	SD-08-46	SD-08-92
5X6W-30R01	SM30-082-00	DS-T09W	SD-08-46	SD-08-92
5X6W-40R01	SM30-082-00	DS-T09W	SD-12-82	SD-12-99
5X6W-60R01	SM30-082-00	DS-T09W	SD-12-82	SD-12-99



ROUGH-AIR™ SERIES 5X6X

0 DEGREE LEAD DOUBLE POSITIVE HIGH SPEED ROUTER FACE MILL

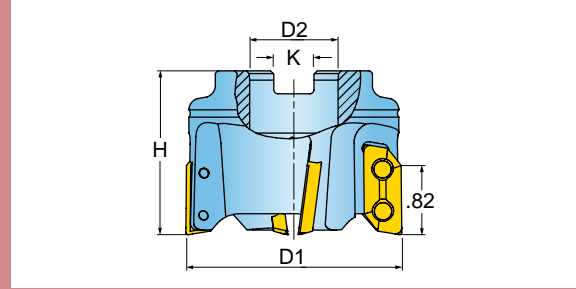

Cutter Number	D1 Effective Diameter	Number of Inserts	H Height	D2 Bore Dia.	K Keyway	Ramp Angles
5X6X-20R01	2.000	3	2.000	0.750	0.312	8.4
5X6X-25R01	2.500	4	2.000	1.000	0.375	6.0
5X6X-30R01	3.000	5	2.375	1.000	0.375	4.7
5X6X-30R02	3.000	3	2.375	1.000	0.375	4.7
5X6X-40R01	4.000	5	2.375	1.500	0.625	3.2
5X6X-50R01	5.000	6	2.375	1.500	0.625	2.5
5X6X-60R01	6.000	7	2.375	1.500	0.625	1.5

Prebalanced to: G6.3 @ 20,000 RPM
Operating guidelines on [page 363](#).



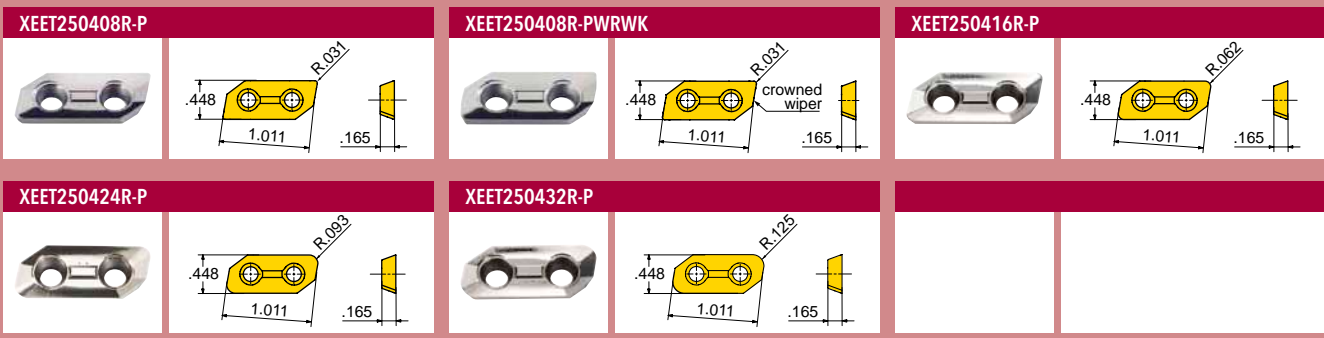

INSERTS



Part Number	Applications	Grade	IN15K									
XEET250408R-P	Grd/Pol for Al - 0.031" R		●									
XEET250408R-PWRWK	Wiper - 0.031" R		●									
XEET250416R-P	Grd/Pol for Al - 0.062" R		●									
XEET250424R-P	Grd/Pol for Al - 0.093" R		●									
XEET250432R-P	Grd/Pol for Al - 0.125" R		●									

● = P ● = M ● = K ● = N ● = S

HARDWARE

					
	Screw	Driver	Retention Bolt	(Optional) Coolant Bolt	
5X6X-20R01	SM40-090-00	DS-T15T	SD-06-47	-	
5X6X-25R01	SM40-090-00	DS-T15T	SD-08-47	-	
5X6X-30R01	SM40-090-00	DS-T15T	SD-08-48	-	
5X6X-30R02	SM40-090-00	DS-T15T	SD-08-48	-	
5X6X-40R01	SM40-090-00	DS-T15T	SD-12-82	SD-12-99	
5X6X-50R01	SM40-090-00	DS-T15T	SD-12-82	SD-12-99	
5X6X-60R01	SM40-090-00	DS-T15T	SD-12-82	SD-12-99	



ROUGH AIR™ SERIES 5X6Z

0 DEGREE LEAD HIGH SPEED ROUTER FACE MILL (FOR ALUMINUM)

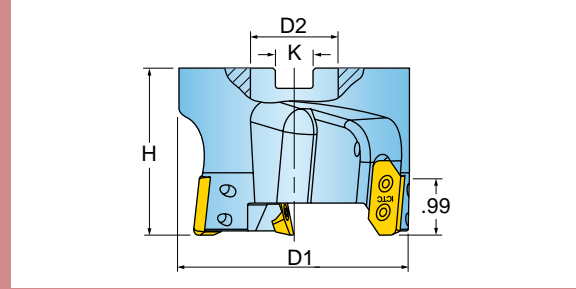

Cutter Number	D1 Effective Diameter	Number of Inserts	H Height	D2 Bore Dia.	K Keyway	Ramp Angle	Bolt Circle
5X6Z-20R01	2.500	3	2.875	1.000	0.375	11	NA
5X6Z-30R01	3.000	3	2.875	1.250	0.500	8	NA
5X6Z-40R01	4.000	3	2.875	1.500	0.625	5	NA
5X6Z-50R01	5.000	3	2.875	1.500	0.625	4	NA
5X6Z-60R01	6.000	3	2.875	1.500	0.625	3	NA

Prebalanced to: G6.3 @ 10,000 RPM
 Operating guidelines on [page 363](#).

INSERTS

XFEB330504R-P

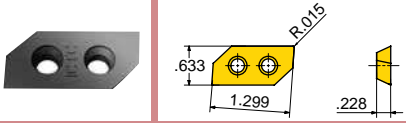

XFEB330508R-P

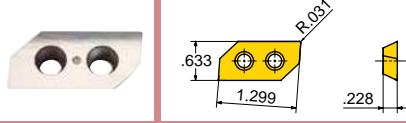

XFEB330508R-PW

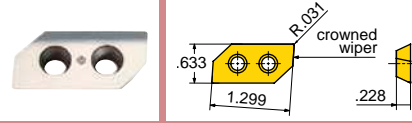

XFEB330516R-P

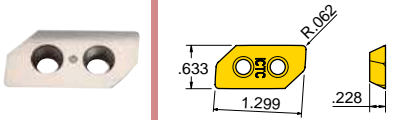

XFEB330516R-PW

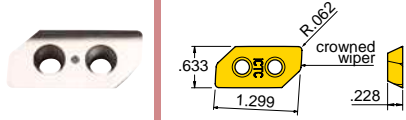

XFEB330532R-P

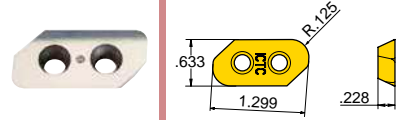

XFEB330550L-P

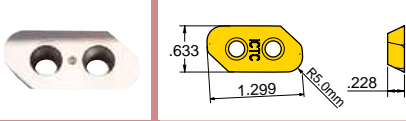

XFEB330550R-P

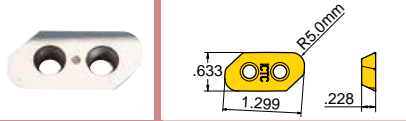

XFEB330564R-P

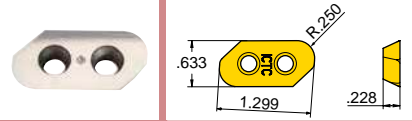

Part Number	Applications	Grade	IN15K										
XFEB330504R-P	Grd/Pol for Al - 0.020" (.5mm) R		●										
XFEB330508R-P	Grd/Pol for Al - 0.031" R		●										
XFEB330508R-PW	Wiper - 0.031" R		●										
XFEB330516R-P	Grd/Pol for Al - 0.062" R		●										
XFEB330516R-PW	Wiper - 0.062" R		●										
XFEB330532R-P	Grd/Pol for Al - 0.125" R		●										
XFEB330550L-P	Grd/Pol for Al - 0.197" (5mm) R		●										
XFEB330550R-P	Grd/Pol for Al - 0.197" (5mm) R		●										
XFEB330564R-P	Grd/Pol for Al - 0.250" R		●										

● = P ● = M ● = K ● = N ● = S

HARDWARE



Screw



Driver



Retention Bolt

5X6Z-20R01	SM50-100-10	DS-T20T	SD-08-48
5X6Z-30R01	SM50-100-10	DS-T20T	SD10-48
5X6Z-40R01	SM50-100-10	DS-T20T	SD-12-89
5X6Z-50R01	SM50-100-10	DS-T20T	SD-12-89
5X6Z-60R01	SM50-100-10	DS-T20T	SD-12-89



0 DEGREE LEAD FACE MILL WITH 4 INDEXES

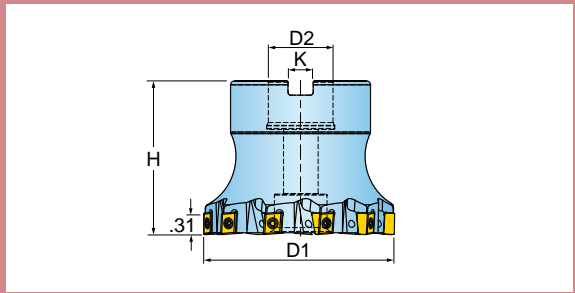

Cutter Number	D1 Effective Diameter	Number of Inserts	H Height	D2 Bore Dia.	K Keyway
SJ5Y-01R01	1.500	6	1.570	0.500	0.250
SJ6Y-01R01	1.500	4	1.570	0.500	0.250
SJ5Y-02R01	2.000	7	1.570	0.750	0.312
SJ6Y-02R01	2.000	5	1.570	0.750	0.312
SJ5Y-02R02	2.500	9	1.570	0.750	0.312
SJ6Y-02R02	2.500	6	1.570	0.750	0.312
SJ5Y-03R01	3.000	11	2.375	1.000	0.375
SJ6Y-03R01	3.000	7	2.375	1.000	0.375

Operating guidelines on [page 355](#).

INSERTS

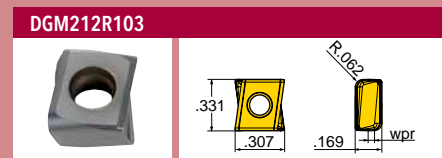
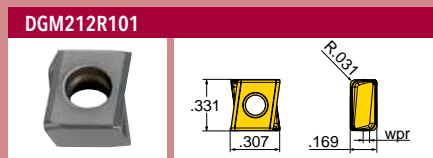
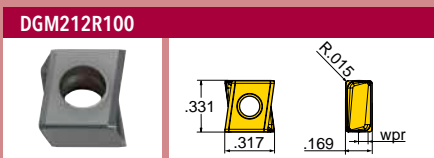

Part Number	Applications	Grade	IN2005	IN2015	IN2030						

DGM212R100	Multi-Purpose - 0.015" R										
DGM212R101	Multi-Purpose - 0.031" R										
DGM212R103	Multi-Purpose - 0.062" R										

● = P ● = M ● = K ● = N ● = S

HARDWARE

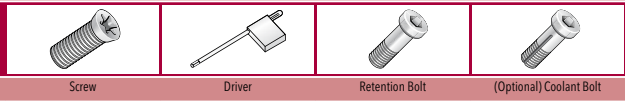

	Screw	Driver	Retention Bolt	(Optional) Coolant Bolt
SJ5Y-01R01	SM30-082-21	DS-T08W	SD-04-46	-
SJ6Y-01R01	SM30-082-21	DS-T08W	SD-04-46	-
SJ5Y-02R01	SM30-082-21	DS-T08W	SD-06-46	SD-06-89
SJ6Y-02R01	SM30-082-21	DS-T08W	SD-06-46	SD-06-89
SJ5Y-02R02	SM30-082-21	DS-T08W	SD-06-46	SD-06-89
SJ6Y-02R02	SM30-082-21	DS-T08W	SD-06-46	SD-06-89
SJ5Y-03R01	SM30-082-21	DS-T08W	SD-08-43	-
SJ6Y-03R01	SM30-082-21	DS-T08W	SD-08-43	-



EVO•TEC™ SERIES SJ6F, SJ5F

0 DEGREE LEAD FACE MILL WITH 4 INDEXES

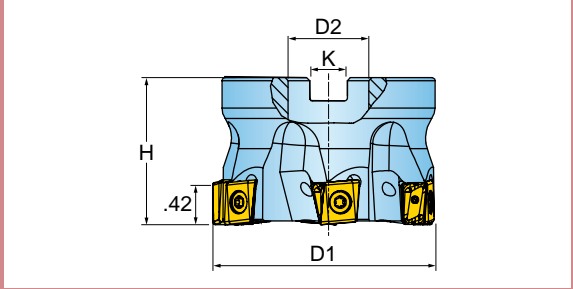

Cutter Number	D1 Effective Diameter	Number of Inserts	H Height	D2 Bore Dia.	K Keyway	Coolant
SJ6F-02R01	2.000	5	1.570	0.750	0.312	Yes
SJ6F-02R02	2.500	6	1.570	0.750	0.312	Yes
SJ5F-03R01	3.000	8	2.375	1.000	0.375	Yes
SJ6F-03R01	3.000	6	2.375	1.000	0.375	Yes
SJ5F-04R01	4.000	9	2.375	1.500	0.625	Yes
SJ6F-04R01	4.000	6	2.375	1.500	0.625	Yes
SJ6F-05R01	5.000	7	2.375	1.500	0.625	No

Operating guidelines on [page 356](#).

INSERTS

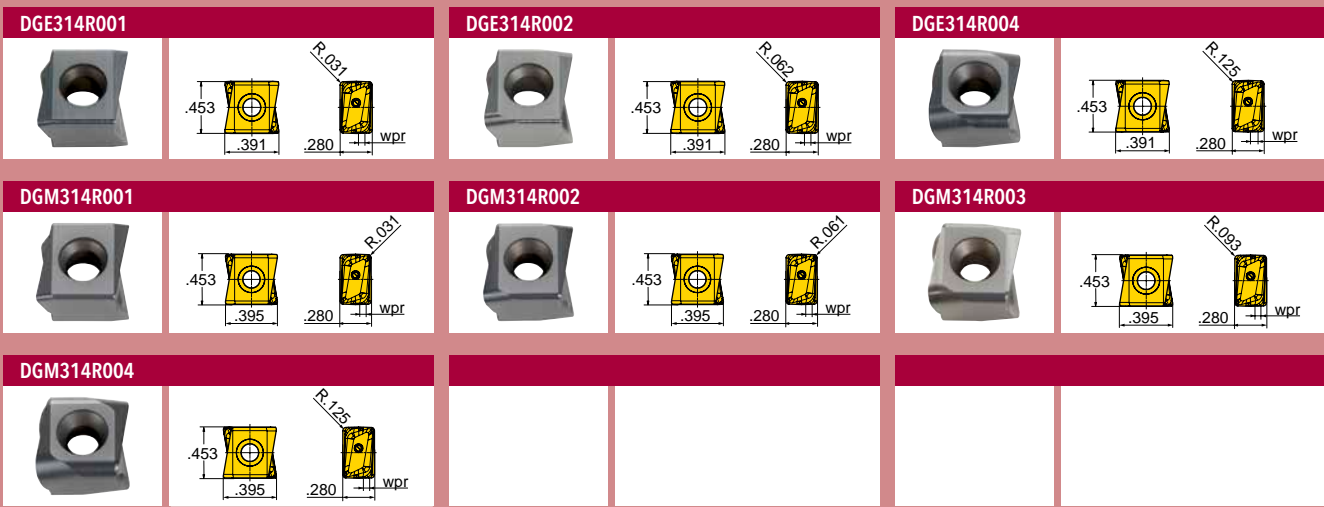

Part Number	Applications	Grade	IN2005	IN2015	IN2030	IN2040	IN6515			
			DGE314R001	SS/Hi-Temp/Ti - 0.031" R			●			
DGE314R002	SS/Hi-Temp/Ti - 0.062" R				●					
DGE314R004	SS/Hi-Temp/Ti - 0.125" R				●					
DGM314R001	Multi-Purpose - 0.031" R		●	●	●	●	●			
DGM314R002	Multi-Purpose - 0.062" R		●	●	●	●	●			
DGM314R003	Multi-Purpose - 0.093" R		●							
DGM314R004	Multi-Purpose - 0.125" R		●	●	●	●	●			

● = P ● = M ● = K ● = N ● = S

HARDWARE

	Screw	Driver	Retention Bolt	(Optional) Coolant Bolt
SJ6F-02R01	SM35-114-H0	DS-T15T	SD-06-46	SD-06-89
SJ6F-02R02	SM35-114-H0	DS-T15T	SD-06-46	SD-06-89
SJ5F-03R01	SM35-114-H0	DS-T15T	SD-08-47	SD-08-92
SJ6F-03R01	SM35-114-H0	DS-T15T	SD-08-47	SD-08-92
SJ5F-04R01	SM35-114-H0	DS-T15T	SD-12-89	SD-12-99
SJ6F-04R01	SM35-114-H0	DS-T15T	SD-12-89	SD-12-99
SJ6F-05R01	SM35-114-H0	DS-T15T	-	-



0 DEGREE LEAD FACE MILL WITH 4 INDEXES



Shoulder



Channel



Facing



Coolant

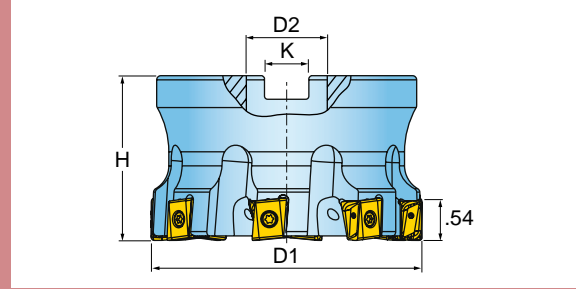

Cutter Number	D1 Effective Diameter	Number of Inserts	H Height	D2 Bore Dia.	K Keyway
SJ5J-03R01	3.000	7	2.375	1.000	0.375
SJ6J-03R01	3.000	5	2.375	1.000	0.375
SJ5J-04R01	4.000	8	2.375	1.500	0.625
SJ6J-04R01	4.000	6	2.375	1.500	0.625

Operating guidelines on [page 356](#).

INSERTS

DGE324R001

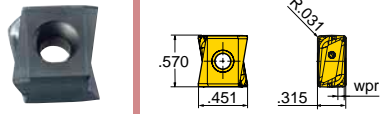

DGE324R002

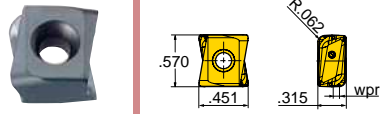

DGE324R004

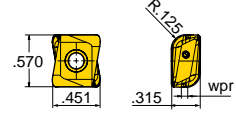

DGM324R001

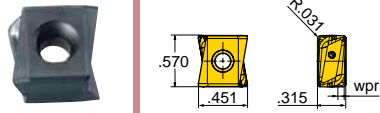

DGM324R002

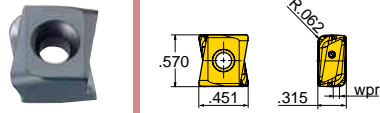

DGM324R003

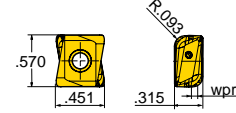

DGM324R004

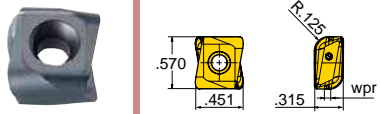

DGM324R201

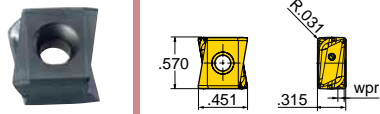

DGM324R202

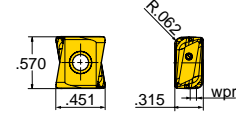

Part Number	Applications	Grade											
			IN2005	IN2015	IN2030	IN2040	IN6515						
DGE324R001	SS/Hi-Temp/Ti - 0.031" R				●								
DGE324R002	SS/Hi-Temp/Ti - 0.062" R				●								
DGE324R004	SS/Hi-Temp/Ti - 0.125" R				●								
DGM324R001	Multi-Purpose - 0.031" R		●	●	●	●	●						
DGM324R002	Multi-Purpose - 0.062" R		●	●	●	●	●						
DGM324R003	Multi-Purpose - 0.093" R		●										
DGM324R004	Multi-Purpose - 0.125" R		●	●	●	●	●						
DGM324R201	Heavy-Duty - 0.031" R		●	●	●	●	●						
DGM324R202	Heavy-Duty - 0.062" R		●	●	●	●	●						

● = P ● = M ● = K ● = N ● = S

HARDWARE



Screw



Driver



Retention Bolt

SJ5J-03R01	SM40-143-H0	DS-T15T	SD-08-48
SJ6J-03R01	SM40-143-H0	DS-T15T	SD-08-48
SJ5J-04R01	SM40-143-H0	DS-T15T	SD-12-82
SJ6J-04R01	SM40-143-H0	DS-T15T	SD-12-82



0 DEGREE LEAD FACE MILL WITH 4 INDEXES



Shoulder



Channel



Facing

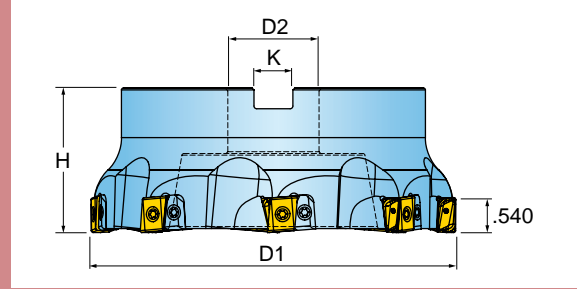

Cutter Number	D1 Effective Diameter	Number of Inserts	H Height	D2 Bore Dia.	K Keyway
SJ2J-05R01	5.000	7	2.375	1.500	0.625
SJ2J-06R01	6.000	8	2.375	1.500	0.625
SJ2J-08R01	8.000	10	2.375	2.500	1.000

Operating guidelines on [page 356](#).

INSERTS

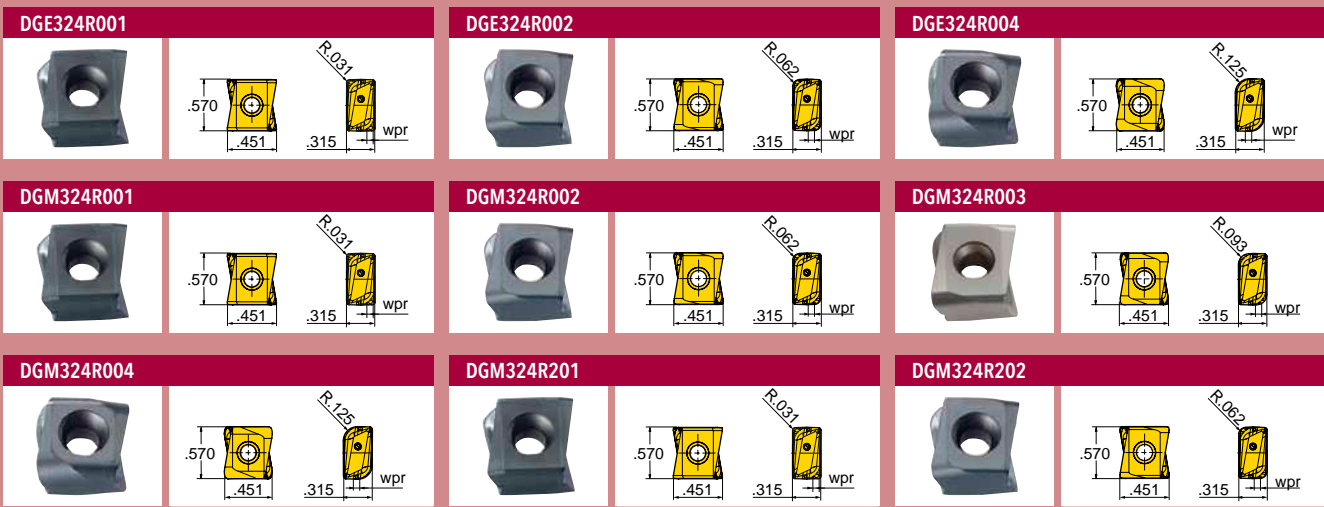

Part Number	Applications	Grade	IN2005	IN2015	IN2030	IN2040	IN6515					
DGE324R001	SS/Hi-Temp/Ti - 0.031" R				●							
DGE324R002	SS/Hi-Temp/Ti - 0.062" R				●							
DGE324R004	SS/Hi-Temp/Ti - 0.125" R				●							
DGM324R001	Multi-Purpose - 0.031" R		●	●	●	●	●					
DGM324R002	Multi-Purpose - 0.062" R		●	●	●	●	●					
DGM324R003	Multi-Purpose - 0.093" R		●									
DGM324R004	Multi-Purpose - 0.125" R		●	●	●	●	●					
DGM324R201	Heavy-Duty - 0.031" R		●	●	●	●	●					
DGM324R202	Heavy-Duty - 0.062" R		●	●	●	●	●					

● = P ● = M ● = K ● = N ● = S



SM40-143-H0	DS-T15T	SM40-143-H0	PAR0646
-------------	---------	-------------	---------



0 DEGREE LEAD FACE MILL WITH 4 INDEXES



Shoulder



Channel



Facing

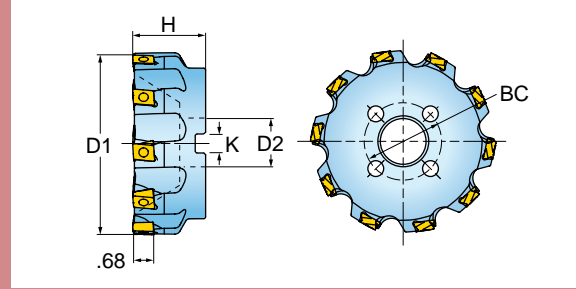

Cutter Number	D1 Effective Diameter	Number of Inserts	H Height	D2 Bore Dia.	Bolt Circle	K Keyway
SJ6N-03R01	3.000	5	2.375	1.000	NA	0.375
SJ6N-04R01	4.000	6	2.375	1.500	NA	0.625
SJ6N-05R01	5.000	8	2.375	1.500	NA	0.625
SJ6N-06R01	6.000	10	2.375	1.500	NA	0.625
SJ6N-08R01	8.000	12	2.375	2.500	4.00	1.000
SJ6N-10R01	10.000	14	2.375	2.500	4.00, 7.00	1.000
SJ6N-12R01	12.000	16	2.375	2.500	4.00, 7.00	1.000

Operating guidelines on [page 366](#).

INSERTS

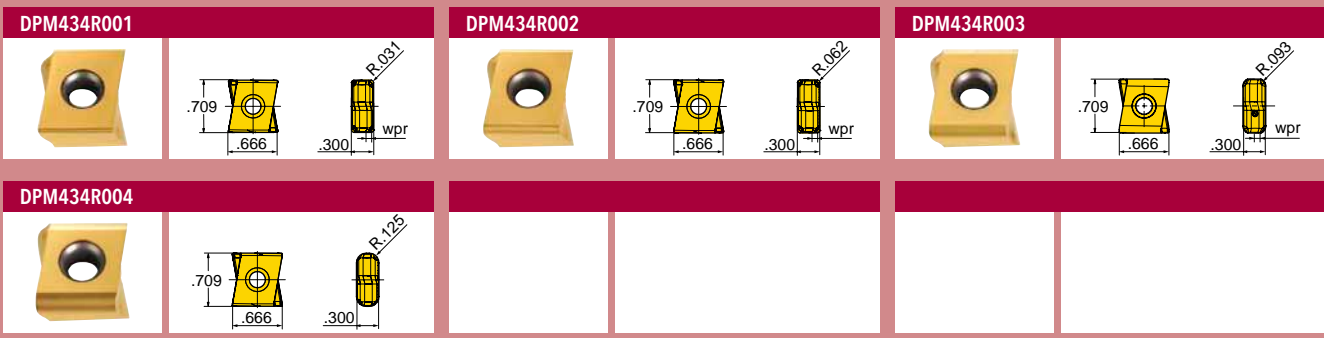

Part Number	Applications	Grade	IN2005	IN2015	IN2030	IN2040	IN2530	IN6515			
-------------	--------------	-------	--------	--------	--------	--------	--------	--------	--	--	--

DPM434R001	Multi-Purpose - 0.031" R		●	●	●	●	●				
DPM434R002	Multi-Purpose - 0.062" R		●	●		●	●	●			
DPM434R003	Multi-Purpose - 0.093" R						●	●			
DPM434R004	Multi-Purpose - 0.125" R		●				●				

● = P ● = M ● = K ● = N ● = S

HARDWARE



	Screw	Driver	Retention Bolt
SJ6N-03R01	SM50-160-10	DS-T20T	SD-08-47
SJ6N-04R01	SM50-160-10	DS-T20T	-
SJ6N-05R01	SM50-160-10	DS-T20T	-
SJ6N-06R01	SM50-160-10	DS-T20T	-
SJ6N-08R01	SM50-160-10	DS-T20T	-
SJ6N-10R01	SM50-160-10	DS-T20T	-
SJ6N-12R01	SM50-160-10	DS-T20T	-



SOMAX™ SERIES SJ2N

0 DEGREE LEAD HEAVY DUTY FACE MILL WITH 4 INDEXES

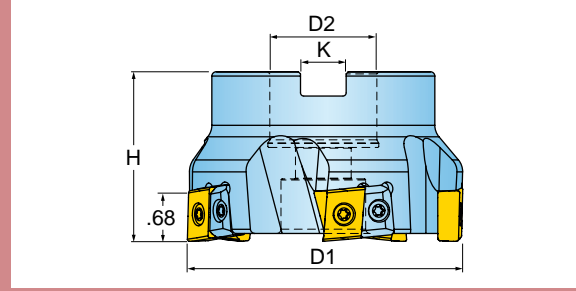

Cutter Number	D1 Effective Diameter	Number of Inserts	H Height	D2 Bore Dia.	Bolt Circle	K Keyway	Accepts Insert Series
SJ2N-04A01	4.000	5	2.375	1.500	NA	0.625	DPM
SJ2N-04A02	4.000	5	2.375	1.500	NA	0.625	DNM
SJ2N-05A01	5.000	6	2.375	1.500	NA	0.625	DPM
SJ2N-05A02	5.000	6	2.375	1.500	NA	0.625	DNM
SJ2N-06A01	6.000	8	2.375	1.500	NA	0.625	DPM
SJ2N-06A02	6.000	8	2.375	1.500	NA	0.625	DNM
SJ2N-08A01	8.000	10	2.375	2.500	4.00	1.000	DPM
SJ2N-08A02	8.000	10	2.375	2.500	4.00	1.000	DNM
SJ2N-10A01	10.000	12	2.375	2.500	4.00, 7.00	1.000	DPM
SJ2N-10A02	10.000	12	2.375	2.500	4.00, 7.00	1.000	DNM
SJ2N-12A01	12.000	14	2.375	2.500	4.00, 7.00	1.000	DPM
SJ2N-12A02	12.000	14	2.375	2.500	4.00, 7.00	1.000	DNM

Operating guidelines on [page 366](#).

INSERTS

DNM434R201

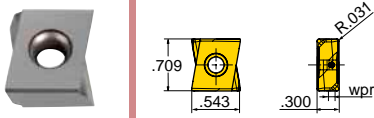

DNM434R202

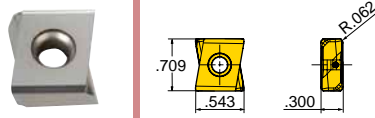

DNM434R203

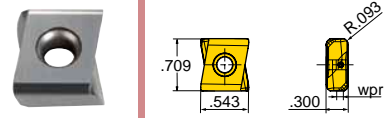

DNM434R204

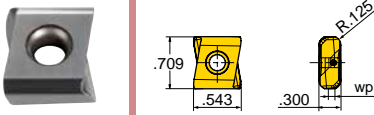

DPM434R001

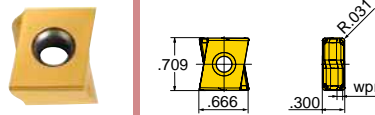

DPM434R002

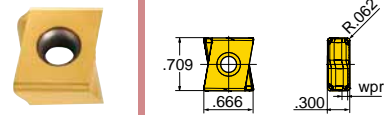

DPM434R003

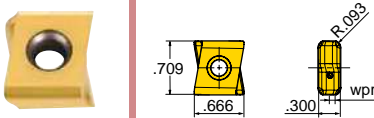

DPM434R004

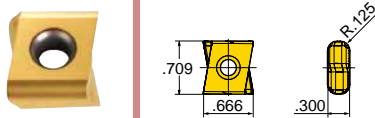

Part Number	Applications	Grade										
			IN2005	IN2015	IN2030	IN2040	IN2530	IN6515				
DNM434R201	Heavy-Duty - 0.031" R		●	●	●	●						
DNM434R202	Heavy-Duty - 0.062" R		●		●	●						
DNM434R203	Heavy-Duty - 0.093" R		●									
DNM434R204	Heavy-Duty - 0.125" R		●									
DPM434R001	Multi-Purpose - 0.031" R		●	●	●	●	●	●				
DPM434R002	Multi-Purpose - 0.062" R		●	●		●	●	●	●	●		
DPM434R003	Multi-Purpose - 0.093" R							●				
DPM434R004	Multi-Purpose - 0.125" R		●					●				

● = P ● = M ● = K ● = N ● = S

HARDWARE



Screw



Anvil



Retention Bolt

SJ2N-04A01	SM50-160-10	PAR0628	SD-12-82
SJ2N-04A02	SM50-160-10	PAR0636	SD-12-82
SJ2N-05A01	SM50-160-10	PAR0628	-
SJ2N-05A02	SM50-160-10	PAR0636	-
SJ2N-06A01	SM50-160-10	PAR0628	-
SJ2N-06A02	SM50-160-10	PAR0636	-
SJ2N-08A01	SM50-160-10	PAR0628	-
SJ2N-08A02	SM50-160-10	PAR0636	-
SJ2N-10A01	SM50-160-10	PAR0628	-
SJ2N-10A02	SM50-160-10	PAR0636	-
SJ2N-12A01	SM50-160-10	PAR0628	-
SJ2N-12A02	SM50-160-10	PAR0636	-



SOMAX™ SERIES SJ2R

0 DEGREE HEAVY DUTY FACE MILL WITH 4 INDEXES



Shoulder



Channel



Facing

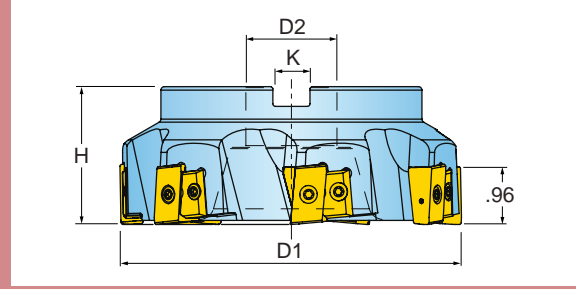

Cutter Number	D1 Effective Diameter	Number of Inserts	H Height	D2 Bore Dia.	K Keyway	Bolt Circle
SJ2R-06R01	6.000	7	2.375	1.500	0.625	NA
SJ2R-08R01	8.000	9	2.375	2.500	1.000	4.00
SJ2R-10R01	10.000	11	2.375	2.500	1.000	4.00, 7.00
SJ2R-12R01	12.000	13	2.375	2.500	1.000	4.00, 7.00

Operating guidelines on [page 365](#).

INSERTS

DPM436R001

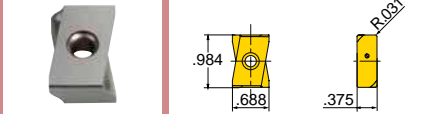

DPM436R002

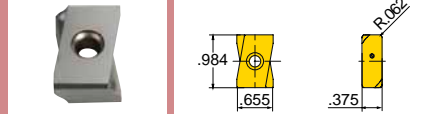

DPM436R003

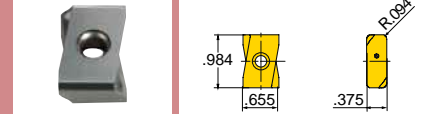

DPM436R004

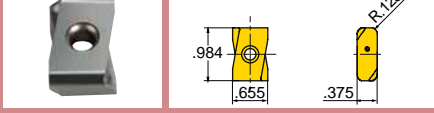

Part Number	Applications	Grade	IN2005	IN2015	IN2030	IN2040	IN2530	IN6515	IN6530
-------------	--------------	-------	--------	--------	--------	--------	--------	--------	--------

DPM436R001	Multi-Purpose - 0.031" R								
DPM436R002	Multi-Purpose - 0.062" R								
DPM436R003	Multi-Purpose - 0.093" R								
DPM436R004	Multi-Purpose - 0.125" R								

= P
 = M
 = K
 = N
 = S

HARDWARE



Screw: **SM50-160-10**
 Driver: **DS-T20T**
 Seat: **PAR0629**



VoMAX™ SERIES VK5V (HIGH DENSITY)

0 DEGREE LEAD HI-DENSITY FACE MILL WITH UP TO 8 INDEXES (4RH & 4LH)

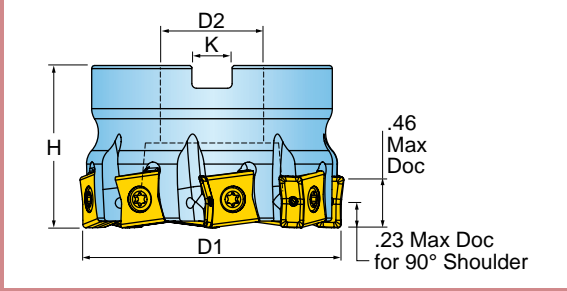

Cutter Number	D1 Effective Diameter	Number of Inserts	H Height	D2 Bore Dia.	Bolt Circle	K Keyway
VK5V-02L01	2.000	6	1.570	0.750	NA	0.312
VK5V-02R01	2.000	6	1.570	0.750	NA	0.312
VK5V-02L25	2.500	8	1.570	1.000	NA	0.375
VK5V-02R25	2.500	8	1.570	1.000	NA	0.375
VK5V-03L01	3.000	10	2.375	1.000	NA	0.375
VK5V-03R01	3.000	10	2.375	1.000	NA	0.375
VK5V-04R01	4.000	13	2.375	1.500	NA	0.625
VK5V-05R01	5.000	16	2.375	1.500	NA	0.625
VK5V-06R01	6.000	21	2.375	1.500	NA	0.625

Operating guidelines on [page 369](#).

INSERTS

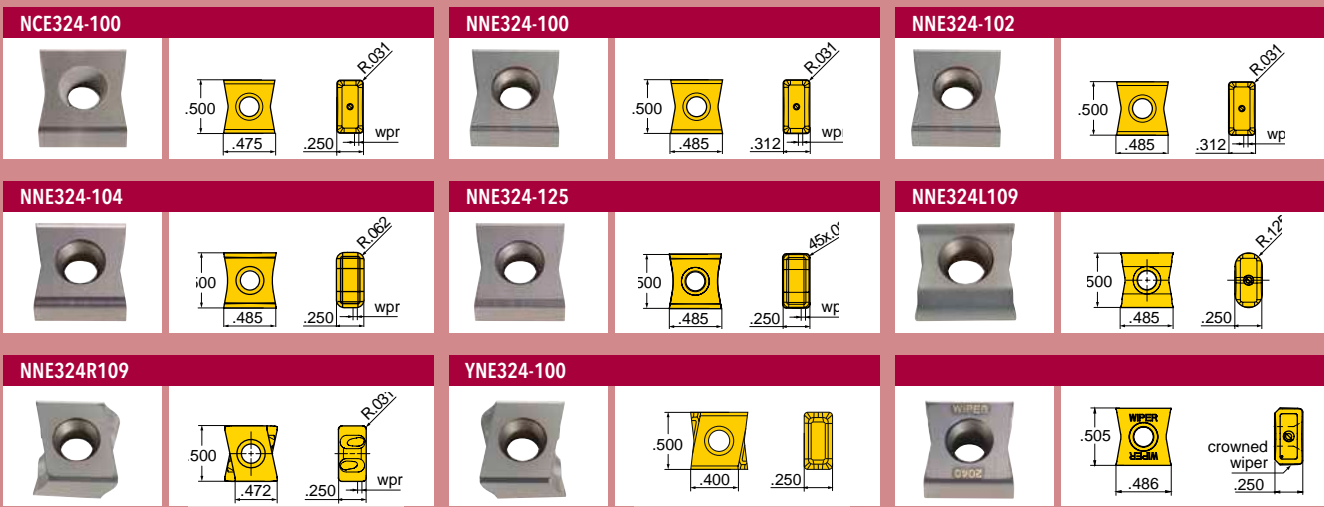

Part Number	Applications	Grade	IN15K	IN2005	IN2010	IN2015	IN2030	IN2040	IN2530	IN6515	IN70N
			NCE324-100	Cast Iron - 0.031" R							
NJE324-100-P	Grd/Pol for Al - 0.031" R	●									
NNE324-100	Multi-Purpose - 0.031" R				●	●	●	●	●	●	●
NNE324-102	Multi-Purpose - 0.062" R				●	●	●	●	●	●	●
NNE324-104	Multi-Purpose - 0.031" Chamfer				●	●		●	●	●	●
NNE324-125	Multi-Purpose - 0.125" R				●	●					
NNE324L109	Multi-Purpose - 0.031" R			●	●	●	●	●		●	●
NNE324R109	Multi-Purpose - 0.031" R			●	●	●	●	●		●	●
YNE324-100	Crowned Wiper - 0.031" R				●	●	●	●		●	●

● = P ● = M ● = K ● = N ● = S

HARDWARE



	Screw	Driver	Retention Bolt
VK5V-02L01	SM40-120-20	DS-T15T	SD-06-46
VK5V-02R01	SM40-120-20	DS-T15T	SD-06-46
VK5V-02L25	SM40-120-20	DS-T15T	-
VK5V-02R25	SM40-120-20	DS-T15T	-
VK5V-03L01	SM40-120-20	DS-T15T	-
VK5V-03R01	SM40-120-20	DS-T15T	-
VK5V-04R01	SM40-120-20	DS-T15T	-
VK5V-05R01	SM40-120-20	DS-T15T	-
VK5V-06R01	SM40-120-20	DS-T15T	-



VoMAX™ SERIES VK6V (MEDIUM-DENSITY)

0 DEGREE LEAD MEDIUM-DENSITY FACE MILL WITH UP TO 8 INDEXES (4RH & 4LH)

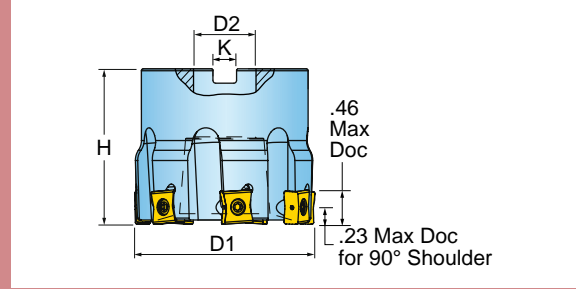

Cutter Number	D1 Effective Diameter	Number of Inserts	H Height	D2 Bore Dia.	Bolt Circle	K Keyway
VK6V-02L01	2.000	5	1.570	0.750	NA	0.312
VK6V-02R01	2.000	5	1.570	0.750	NA	0.312
VK6V-02L25	2.500	6	1.570	1.000	NA	0.375
VK6V-02R25	2.500	6	1.570	1.000	NA	0.375
VK6V-03L01	3.000	8	2.375	1.000	NA	0.375
VK6V-03R01	3.000	8	2.375	1.000	NA	0.375
VK6V-04L01	4.000	9	2.375	1.500	NA	0.625
VK6V-04R01	4.000	9	2.375	1.500	NA	0.625
VK6V-05L01	5.000	10	2.375	1.500	NA	0.625
VK6V-05R01	5.000	10	2.375	1.500	NA	0.625
VK6V-06L01	6.000	13	2.375	1.500	NA	0.625
VK6V-06R01	6.000	13	2.375	1.500	NA	0.625

Operating guidelines on [page 369](#).

INSERTS

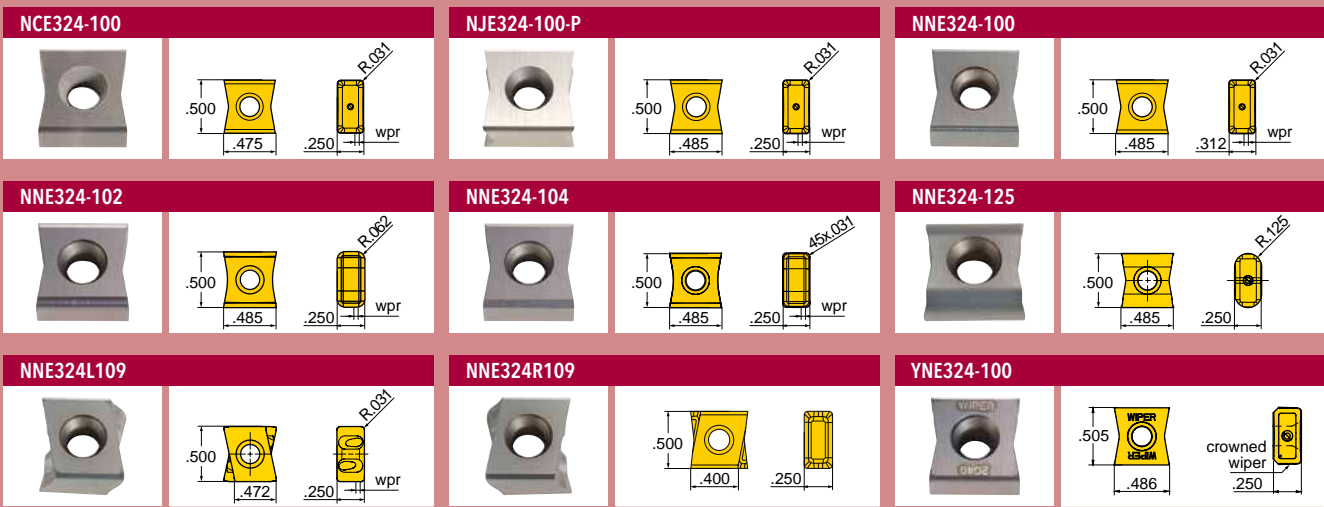

Part Number	Applications	Grade	IN15K	IN2005	IN2010	IN2015	IN2030	IN2040	IN2530	IN6515	IN70N
NCE324-100	Cast Iron - 0.031" R										●
NJE324-100-P	Grd/Pol for Al - 0.031" R	●									
NNE324-100	Multi-Purpose - 0.031" R				●	●	●	●	●	●	●
NNE324-102	Multi-Purpose - 0.062" R				●	●	●	●	●	●	●
NNE324-104	Multi-Purpose - 0.031" Chamfer				●	●		●	●	●	●
NNE324-125	Multi-Purpose - 0.125" R				●		●				
NNE324L109	Multi-Purpose - 0.031" R			●		●	●	●			●
NNE324R109	Multi-Purpose - 0.031" R			●		●	●	●			●
YNE324-100	Crowned Wiper - 0.031" R					●	●	●			●

● = P ● = M ● = K ● = N ● = S

HARDWARE



	Screw	Driver	Retention Bolt
VK6V-02L01	SM40-120-20	DS-T15T	SD-06-46
VK6V-02R01	SM40-120-20	DS-T15T	SD-06-46
VK6V-02L25	SM40-120-20	DS-T15T	-
VK6V-02R25	SM40-120-20	DS-T15T	-
VK6V-03L01	SM40-120-20	DS-T15T	-
VK6V-03R01	SM40-120-20	DS-T15T	-
VK6V-04L01	SM40-120-20	DS-T15T	-
VK6V-04R01	SM40-120-20	DS-T15T	-
VK6V-05L01	SM40-120-20	DS-T15T	-
VK6V-05R01	SM40-120-20	DS-T15T	-
VK6V-06L01	SM40-120-20	DS-T15T	-
VK6V-06R01	SM40-120-20	DS-T15T	-



VoMAX™ SERIES VK6V (COARSE-DENSITY)

0 DEGREE LEAD COARSE-DENSITY FACE MILL WITH UP TO 8 INDEXES (4RH & 4LH)

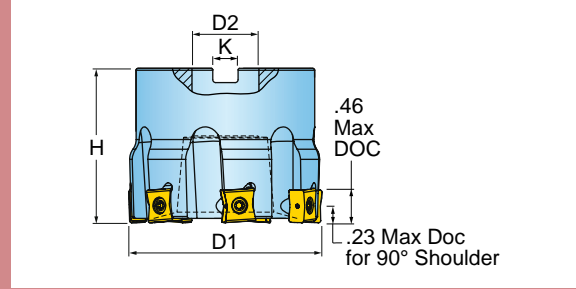
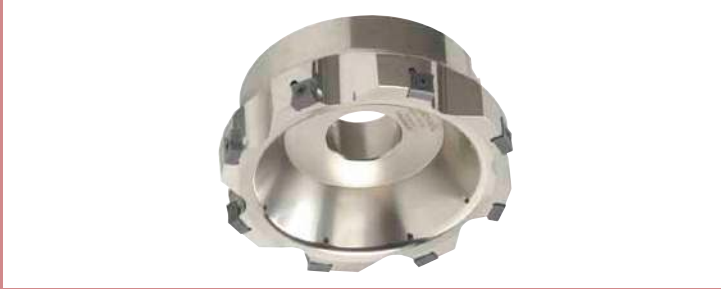

Cutter Number	D1 Effective Diameter	Number of Inserts	H Height	D2 Bore Dia.	K Keyway
VK6V-02L02	2.000	3	1.570	0.750	0.312
VK6V-02R02	2.000	3	1.570	0.750	0.312
VK6V-03L02	3.000	5	1.570	1.000	0.375
VK6V-03R02	3.000	5	2.375	1.000	0.375
VK6V-04L02	4.000	6	2.375	1.500	0.625
VK6V-04R02	4.000	6	2.375	1.500	0.625
VK6V-06L02	6.000	8	2.375	1.500	0.625
VK6V-06R02	6.000	8	2.375	1.500	0.625

Operating guidelines on [page 369](#).

INSERTS

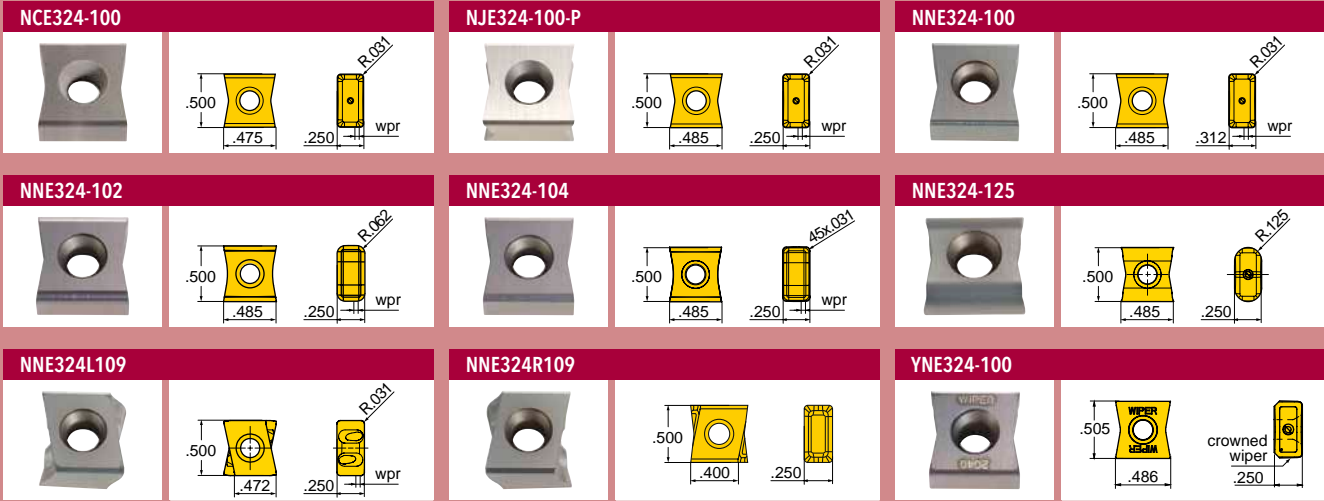

Part Number	Applications	Grade	IN15K	IN2005	IN2010	IN2015	IN2030	IN2040	IN2530	IN6515	IN70N
NCE324-100	Cast Iron - 0.031" R										●
NJE324-100-P	Grd/Pol for Al - 0.031" R	●									
NNE324-100	Multi-Purpose - 0.031" R			●	●	●	●	●	●	●	●
NNE324-102	Multi-Purpose - 0.062" R				●	●	●	●	●	●	●
NNE324-104	Multi-Purpose - 0.031" Chamfer			●	●			●	●	●	●
NNE324-125	Multi-Purpose - 0.125" R			●			●				
NNE324L109	Multi-Purpose - 0.031" R			●		●	●	●			●
NNE324R109	Multi-Purpose - 0.031" R			●		●	●	●			●
YNE324-100	Crowned Wiper - 0.031" R					●	●	●			●

● = P ● = M ● = K ● = N ● = S

HARDWARE



	Screw	Driver	Retention Bolt
VK6V-02L02	SM40-120-20	DS-T15T	SD-06-46
VK6V-02R02	SM40-120-20	DS-T15T	SD-06-46
VK6V-03L02	SM40-120-20	DS-T15T	-
VK6V-03R02	SM40-120-20	DS-T15T	-
VK6V-04L02	SM40-120-20	DS-T15T	-
VK6V-04R02	SM40-120-20	DS-T15T	-
VK6V-06L02	SM40-120-20	DS-T15T	-
VK6V-06R02	SM40-120-20	DS-T15T	-

3 DEGREE LEAD FACE MILL WITH 8 INDEXES

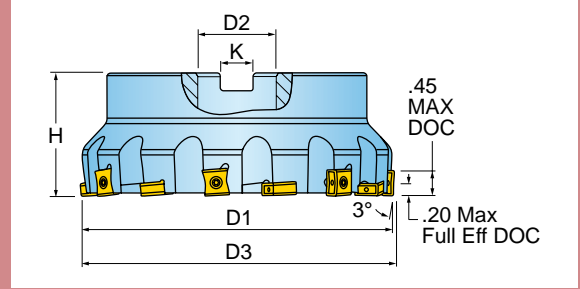

Cutter Number	D1 Effective Diameter	Number of Inserts	H Height	D2 Bore Dia.	D3 Overall Diameter	Bolt Circle	K Keyway
VL6V-02R25	2.500	6	2.375	1.000	2.59	NA	0.375
VL6V-03R01	3.000	8	2.375	1.000	3.09	NA	0.375
VL6V-04R01	4.000	10	2.375	1.500	4.09	NA	0.625
VL6V-05R01	5.000	12	2.375	1.500	5.09	NA	0.625
VL6V-06R01	6.000	14	2.375	1.500	6.09	NA	0.625
VL6V-08R01	8.000	18	2.375	2.500	8.09	4.00	1.000
VL6V-10R01	10.000	22	2.375	2.500	10.09	4.00, 7.00	1.000
VL6V-12R01	12.000	26	2.375	2.500	12.09	4.00, 7.00	1.000

Operating guidelines on [page 369](#).

INSERTS

NCE324R107

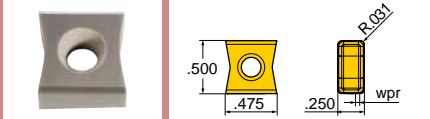

NNE324R107

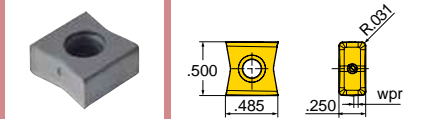

Part Number	Applications	Grade	IN2005	IN2015	IN2030	IN2040	IN6515	IN70N			
-------------	--------------	-------	--------	--------	--------	--------	--------	-------	--	--	--

NCE324R107 SiNi for Iron - 0.031" R

NNE324R107 Multi-Purpose - 0.031" R



● = P ● = M ● = K ● = N ● = S

HARDWARE



VL6V-02R25	SM40-120-20	DS-T15T	SD-08-48
VL6V-03R01	SM40-120-20	DS-T15T	-
VL6V-04R01	SM40-120-20	DS-T15T	-
VL6V-05R01	SM40-120-20	DS-T15T	-
VL6V-06R01	SM40-120-20	DS-T15T	-
VL6V-08R01	SM40-120-20	DS-T15T	-
VL6V-10R01	SM40-120-20	DS-T15T	-
VL6V-12R01	SM40-120-20	DS-T15T	-

FINISHING FACE MILL WITH 4 INDEXES

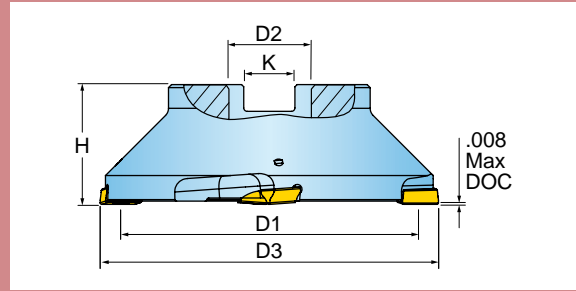
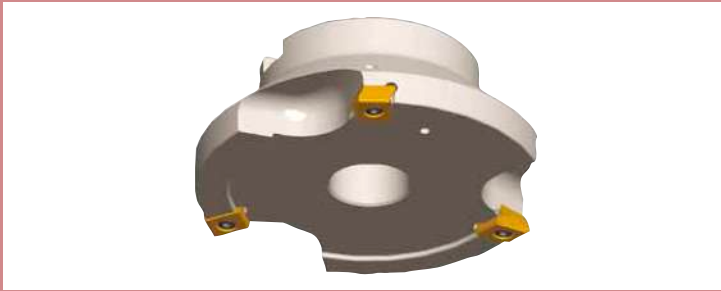

Cutter Number	D1 Effective Diameter	Number of Inserts	H Height	D2 Bore Dia.	D3 Overall Diameter	Bolt Circle	K Keyway	Accepts Insert Series
SF6H-03R01	3.000	3	1.750	1.250	3.50	NA	0.500	YXM324
SF6H-04R01	4.000	3	1.750	1.250	4.50	NA	0.500	YXM324
SF6N-06R01	6.000	4	2.375	2.500	6.71	NA	1.000	YXM434
SF6N-08R01	8.000	6	2.375	2.500	8.71	4.00	1.000	YXM434

Operating guidelines on [page 366](#).

INSERTS

YXM324L001

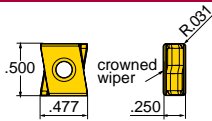

YXM434L001

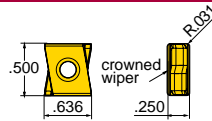

Part Number	Applications	Grade					
			IN1505	IN1510	IN1540		
YXM324L001	Finishing - 0.031" R		●	●	●		
YXM434L001	Finishing - 0.031" R		●	●	●		

● = P ● = M ● = K ● = N ● = S

HARDWARE



Screw

Driver

Retention Bolt

SF6H-03R01	SM40-120-20	DS-T15T	SD-10-47
SF6H-04R01	SM40-120-20	DS-T15T	SD-10-47
SF6N-06R01	SM50-160-10	DS-T20T	-
SF6N-08R01	SM50-160-10	DS-T20T	-

Ingersoll

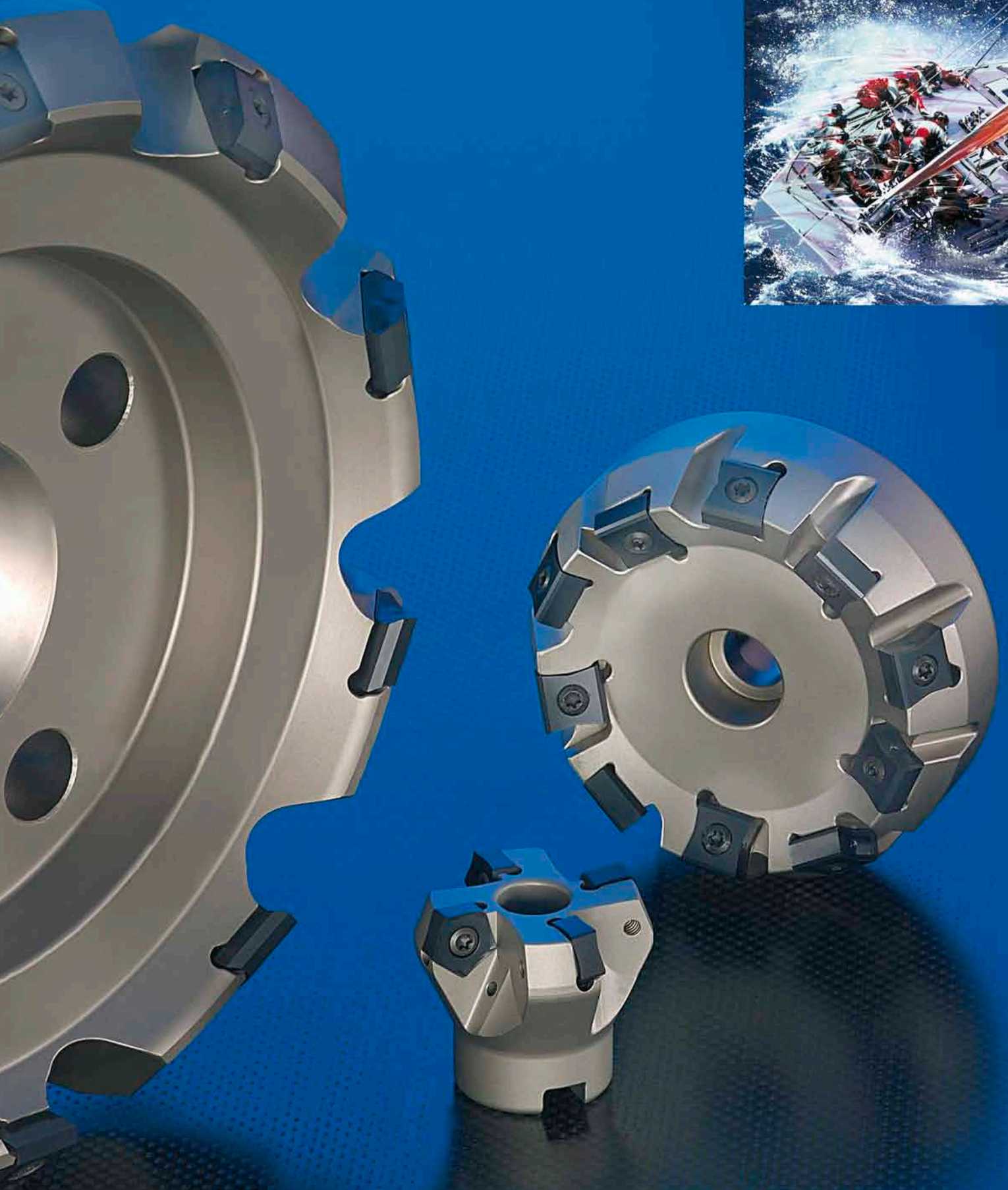

CUTTING TOOLS

CUTTING TOOLS

LEAD ANGLE FACE MILLS.

Cutting Tools

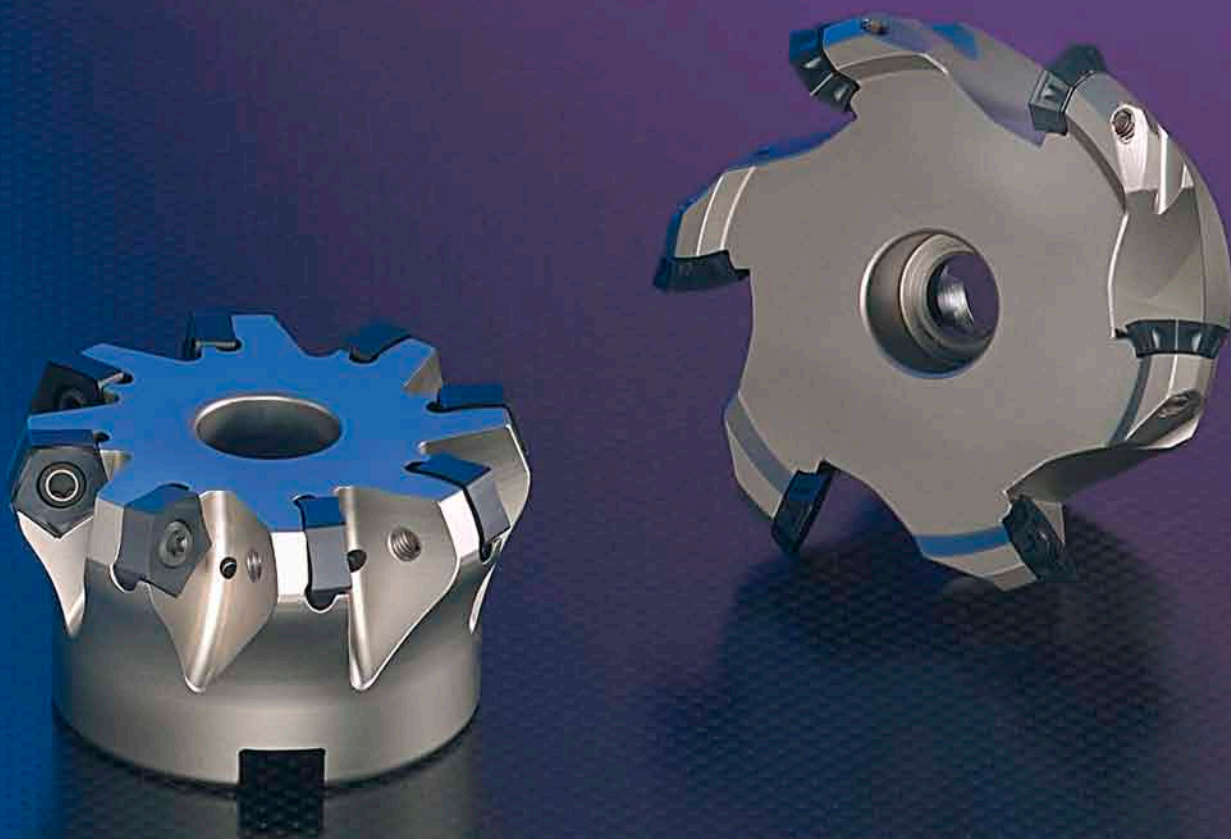

Member IMC Group
Ingersoll
Cutting Tools



LEAD ANGLE FACE MILLS.

	Diameter Range	Cutting Length	Description	Series	Page
	1.500 - 6.000	.31	OCTOPLUS™ 45° Lead Face Mill (Screw Held - 5mm insert)	ON5H - ON6H	166
	3.000 - 12.000	.55	OCTOPLUS™ 45° Lead Face Mill (Wedge Held - 9mm insert)	OP1N	168
	2.500 - 12.000	.55	OCTOPLUS™ 45° Lead Face Mill (Screw Held - 9mm insert)	OP6N	170
	2.000 - 4.000	.32	CHASEOCTO™ 45° Lead Face Mill (Screw Held - 5mm insert)	5N6H	172
	2.000 - 6.000	.46	CHASEOCTO™ 45° Lead Face Mill (Screw Held - 7mm insert)	5N6L	173
	2.120 - 5.620	.42	CHASEOCTO™ 45° Lead Face Mill (Screw Held - 6mm insert)	5N6K	174
	1.500 - 8.000	.23	HIPOSDEKA™ 20° Lead Face Mill	DM6G, DM5G	176
	3.000 - 12.000	.50	HIPOSDEKA^{HD}™ 20° Lead Face Mill - Heavy Duty	DM6Q, DM5Q	178
	6.000 - 12.000	.50	HIPOSDEKA^{HD}™ 20° Lead Heavy Duty Face Mill w/ Pocket Protection	DM2Q	180
	1.250 - 3.000	.18	HIPOSQUAD™ 45° Lead Face Mill	5N6F	181

	Diameter Range	Cutting Length	Description	Series	Page
	2.000 - 8.000	.26	HI-POSQUAD™ 45° Lead Face Mill	5N2H	182
	2.000 - 6.000	.31	TETRA™ 45° Lead Face Mill	TN1N	183
	2.000 - 6.000	.355	ISO-PLUS™ 15° Lead Face Mill	DL6H, DL5H	184
	2.000 - 6.000	.235	ISO-PLUS™ 15° Lead Face Mill	DN6H, DN5H	186
	2.000 - 4.000	.39	HI-POSQUAD™ 45° Lead Face Mill	5N6J	188
	3.000 - 8.000	.40	HI-POSQUAD™ High Axial Shear 45° Lead Face Mill	5N6R	190
	2.500 - 12.000	.43	V-MAX™ 30° Lead Face Mill	VM6V	192
	3.000 - 8.000	.30	V-MAX^{HD}™ 30° Lead Face Mill	VM2N	193
	3.000 - 6.000	.32	EVO-TEC™ 45° Lead Face Mill	SN6J, SN2J	194
	3.000 - 12.000	.35	SO-MAX™ 45° Lead Heavy Feed Face Mill	SN6N	195



LEAD ANGLE FACE MILLS.

	Diameter Range	Cutting Length	Description	Series	Page
	4.000 - 12.000	.35	SoMAX 45° Lead Heavy Duty Face Mill	SN2N	196
	4.000 - 12.000	various	Multiple Geometry Cartridge Face Mill	4W2A	198
	4.000 - 12.000	.50	SoMAX 45° Lead Heavy Duty Face Mill	SN2R	200

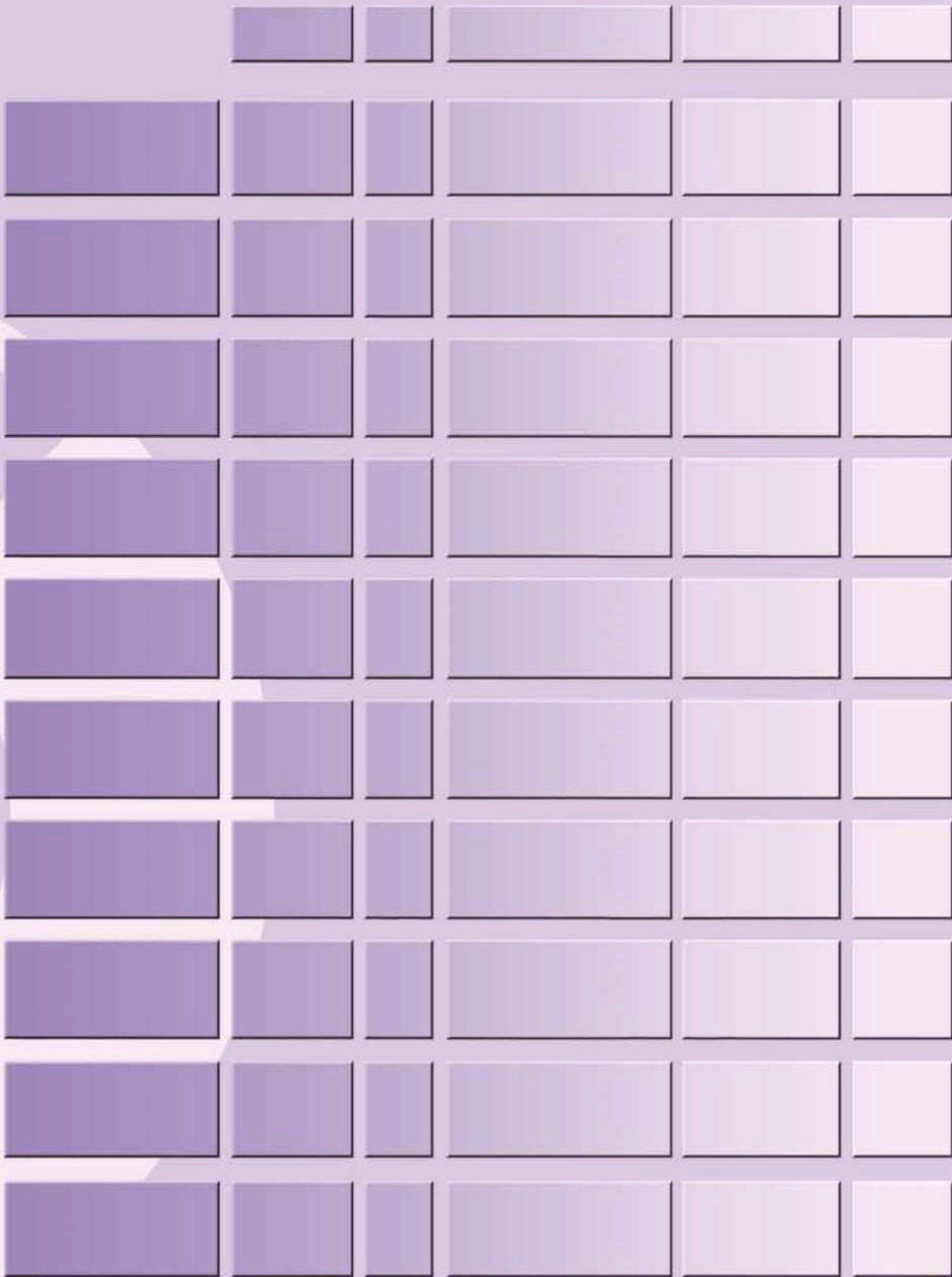

OCTOPLUS™ SERIES ON5H ON6H

45 DEGREE LEAD FACE MILL (SCREW HELD - 5MM INSERT)
WITH 16 INDEXES

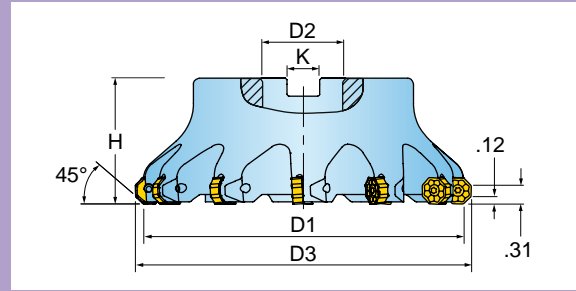

Cutter Number	D1 Effective Diameter	D3 Overall Diameter	Number of Inserts	H Height	D2 Bore Dia.	K Keyway	Coolant
ON6H-15R01	1.500	1.83	4	1.570	0.500	0.250	Yes
ON5H-20R01	2.000	2.33	6	1.570	0.750	0.312	Yes
ON6H-20R01	2.000	2.33	4	1.570	0.750	0.312	Yes
ON6H-25R01	2.500	2.83	6	1.570	0.750	0.312	Yes
ON5H-30R01	3.000	3.33	10	1.750	1.000	0.375	Yes
ON6H-30R01	3.000	3.33	7	1.750	1.000	0.375	Yes
ON5H-40R01	4.000	4.33	12	2.375	1.500	0.625	Yes
ON6H-40R01	4.000	4.33	8	2.375	1.500	0.625	Yes
ON6H-50R01	5.000	5.33	10	2.375	1.500	0.625	Yes
ON5H-60R01	6.000	6.33	18	2.375	1.500	0.625	No
ON6H-60R01	6.000	6.33	12	2.375	1.500	0.625	No

Operating guidelines on [page 362](#).

INSERTS

ONCU0505ANEN

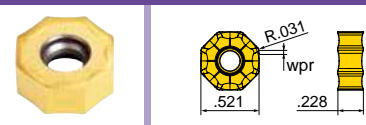

ONCU0505ANFN-P

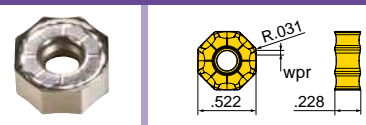

ONCU0505ANTN-HR

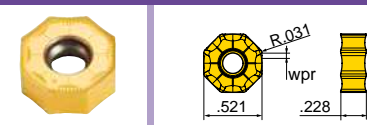

ONCU0505ANTN-W

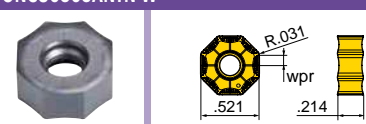

Part Number	Applications	Grade	IN10K	IN2005	IN2010	IN2030	IN2505				
-------------	--------------	-------	-------	--------	--------	--------	--------	--	--	--	--

ONCU0505ANEN	Medium, pos. rake angle - 0.031" R										
ONCU0505ANFN-P	Grd/Pol for Al - 0.031" R		●								
ONCU0505ANTN-HR	Positive Geometry - 0.031" R			●	●	●	●				
ONCU0505ANTN-W	Wiper - 0.031" R						●				

● = P ● = M ● = K ● = N ● = S

HARDWARE



Screw Driver Retention Bolt (Optional) Coolant Bolt

ON6H-15R01	SM40-100-10	DS-T15T	SD-04-86	-
ON5H-20R01	SM40-100-10	DS-T15T	SD-06-46	SD-06-89
ON6H-20R01	SM40-100-10	DS-T15T	SD-06-46	SD-06-89
ON6H-25R01	SM40-100-10	DS-T15T	SD-06-46	SD-06-89
ON5H-30R01	SM40-100-10	DS-T15T	SD-08-46	SD-08-92
ON6H-30R01	SM40-100-10	DS-T15T	SD-08-46	SD-08-92
ON5H-40R01	SM40-100-10	DS-T15T	SD-12-82	SD-12-99
ON6H-40R01	SM40-100-10	DS-T15T	SD-12-82	SD-12-99
ON6H-50R01	SM40-100-10	DS-T15T	SD-12-82	SD-12-99
ON5H-60R01	SM40-100-10	DS-T15T	-	-
ON6H-60R01	SM40-100-10	DS-T15T	-	-

45 DEGREE LEAD FACE MILL (WEDGE HELD - 9MM INSERT)
WITH 16 INDEXES

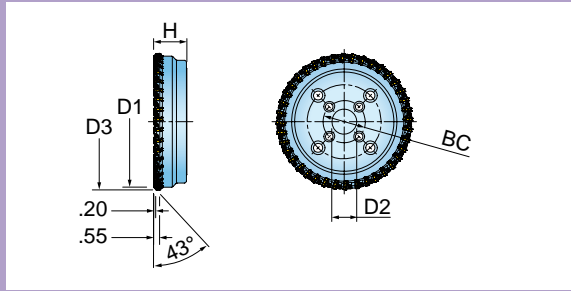

Cutter Number	D1 Effective Diameter	D3 Overall Diameter	Number of Inserts	H Height	D2 Bore Dia.	K Keyway	Bolt Circle
OP1N-30R01	3.000	3.53	8	1.750	1.000	0.375	NA
OP1N-40R01	4.000	4.53	12	2.375	1.500	0.625	NA
OP1N-50R01	5.000	5.53	15	2.375	1.500	0.625	NA
OP1N-60R01	6.000	6.53	19	2.375	1.500	0.625	NA
OP1N-80L01	8.000	8.53	24	2.375	2.500	1.000	4.00
OP1N-80R01	8.000	8.53	24	2.375	2.500	1.000	4.00
OP1N-10L01	10.000	10.53	30	2.375	2.500	1.000	4.00
OP1N-10R01	10.000	10.53	30	2.375	2.500	1.000	4.00
OP1N-12L01	12.000	12.53	38	2.375	2.500	1.000	4.00, 7.00
OP1N-12R01	12.000	12.53	38	2.375	2.500	1.000	4.00, 7.00

Operating guidelines on [page 362](#).

INSERTS

ONCU090612FN-P

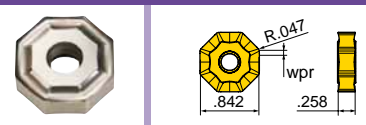

ONCU090612TN-HR

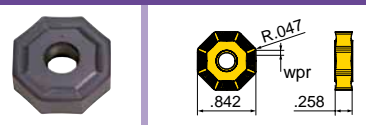

ONCU090612TN-W

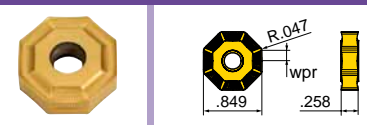

ONCU0906ANFN-WE

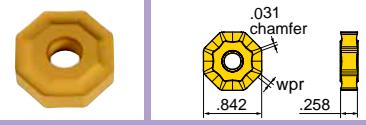

Part Number	Applications	Grade	IN10K	IN2004	IN2005	IN2030	IN2040	IN2505	IN2510	IN6515
-------------	--------------	-------	-------	--------	--------	--------	--------	--------	--------	--------

ONCU090612FN-P	Grd/Pol for Al - 0.047" R		●							
ONCU090612TN-HR	Multi-Purpose - 0.047" R			●	●	●	●			
ONCU090612TN-W	Wiper - 0.047" R							●		
ONCU0906ANFN-WE	Cast Iron - 0.031" Faceted			●					●	●

● = P ● = M ● = K ● = N ● = S ● = H

HARDWARE



	Driver	Wedge	Retention Bolt	Adjusting Screw
OP1N-30R01	DS-H04T	2M0813-01	SD-08-46	SB080-03
OP1N-40R01	DS-H04T	2M0813-01	SD-12-82	SB080-03
OP1N-50R01	DS-H04T	2M0813-01	SD-12-82	SB080-03
OP1N-60R01	DS-H04T	2M0813-01	SD-12-82	SB080-03
OP1N-80L01	DS-H04T	2M0813-01	-	SB080-03
OP1N-80R01	DS-H04T	2M0813-01	-	SB080-03
OP1N-10L01	DS-H04T	2M0813-01	-	SB080-03
OP1N-10R01	DS-H04T	2M0813-01	-	SB080-03
OP1N-12L01	DS-H04T	2M0813-01	-	SB080-03
OP1N-12R01	DS-H04T	2M0813-01	-	SB080-03

OCTOPLUS™ SERIES OP6N

45 DEGREE LEAD FACE MILL (SCREW HELD - 9MM INSERT)
WITH 16 INDEXES

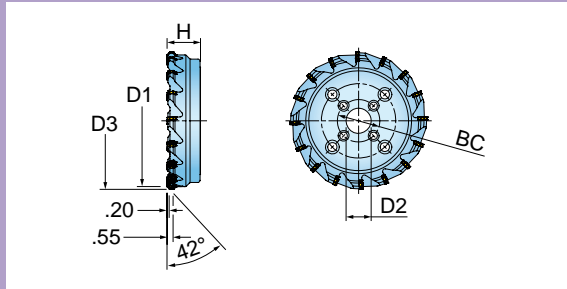

Cutter Number	D1 Effective Diameter	D3 Overall Diameter	Number of Inserts	H Height	D2 Bore Dia.	K Keyway	Bolt Circle	Coolant
OP6N-25R01	2.500	3.04	5	1.570	0.750	0.312	NA	Yes
OP6N-30R01	3.000	3.54	6	1.750	1.000	0.375	NA	Yes
OP6N-40R01	4.000	4.54	7	2.375	1.500	0.625	NA	Yes
OP6N-50R01	5.000	5.54	8	2.375	1.500	0.625	NA	Yes
OP6N-60R01	6.000	6.54	10	2.375	1.500	0.625	NA	No
OP6N-80R01	8.000	8.54	12	2.375	2.500	1.000	4.00	No
OP6N-10R01	10.000	10.54	14	2.375	2.500	1.000	4.00	No
OP6N-12R01	12.000	12.54	16	2.375	2.500	1.000	4.00, 7.00	No

Operating guidelines on [page 362](#).

INSERTS

ONCU090612FN-P

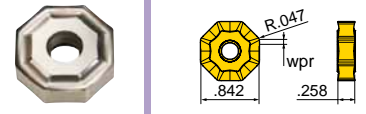

ONCU090612TN-HR

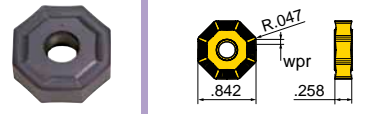

ONCU090612TN-W

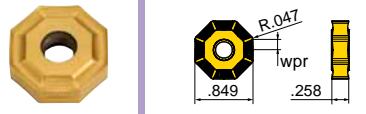

ONCU0906ANFN-WE

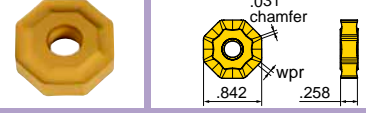

Part Number	Applications	Grade	IN10K	IN2004	IN2005	IN2030	IN2040	IN2505	IN2510	IN6515
-------------	--------------	-------	-------	--------	--------	--------	--------	--------	--------	--------

ONCU090612FN-P	Grd/Pol for Al - 0.047" R		●							
ONCU090612TN-HR	Multi-Purpose - 0.047" R			●	●	●	●			
ONCU090612TN-W	Wiper - 0.047" R							●		
ONCU0906ANFN-WE	Cast Iron - 0.031" Faceted			●					●	●

● = P ● = M ● = K ● = N ● = S ○ = H

HARDWARE



	Screw	Driver	Retention Bolt	(Optional) Coolant Bolt
OP6N-25R01	SM50-130-R0	DS-T20T	SD-06-46	SD-06-89
OP6N-30R01	SM50-130-R0	DS-T20T	SD-08-46	SD-08-92
OP6N-40R01	SM50-130-R0	DS-T20T	SD-12-82	SD-12-99
OP6N-50R01	SM50-130-R0	DS-T20T	SD-12-82	SD-12-99
OP6N-60R01	SM50-130-R0	DS-T20T	-	-
OP6N-80R01	SM50-130-R0	DS-T20T	-	-
OP6N-10R01	SM50-130-R0	DS-T20T	-	-
OP6N-12R01	SM50-130-R0	DS-T20T	-	-

45 DEGREE LEAD ANGLE FACE MILL (SCREW HELD - 5MM INSERT)

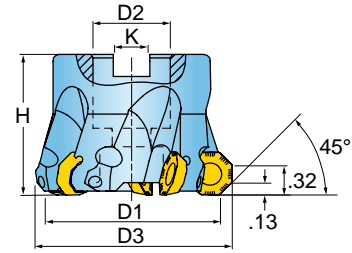

Cutter Number	D1 Nominal Diameter	D3 Overall Dia. (Octo)	D3 Overall Dia. (Button)	No. of Inserts	H Height	D2 Bore Dia.	K Keyway	Ramp Angle
5N6H-20R00	2.000	2.290	2.340	5	1.570	0.750	0.312	4.3
5N6H-25R00	2.500	2.790	2.840	6	1.570	0.750	0.312	3.3
5N6H-30R00	3.000	3.290	3.340	7	1.750	1.000	0.375	2.6
5N6H-40R00	4.000	4.290	4.340	8	2.000	1.500	0.625	2.0

Operating guidelines on [page 363](#).

INSERTS

OFCT05T3AFFN-P

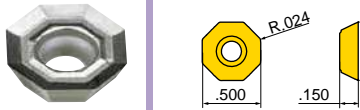

OFCT05T3TN

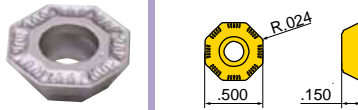

OFMT05T3AFN-HR

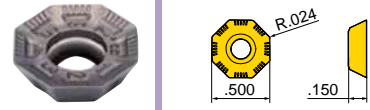

RFMT1404M0N-F



Part Number

Applications

Grade

IN1030

IN2005

IN2040

IN30M

IN10K

OFCT05T3AFFN-P

Grd/Pol for Al - 0.024" R



OFCT05T3TN

Medium, pos. rake angle - 0.024" R



OFMT05T3AFN-HR

Multi-Purpose - 0.024" R



RFMT1404M0N-F

Button - 0.275" R



● = P ● = M ● = K ● = N ● = S

HARDWARE



Screw

Driver

Retention Bolt

5N6H-20R00

SM40-093-20

DS-T15T

SD-06-46

5N6H-25R00

SM40-093-20

DS-T15T

SD-06-46

5N6H-30R00

SM40-093-20

DS-T15T

-

5N6H-40R00

SM40-093-20

DS-T15T

-

45 DEGREE LEAD ANGLE FACE MILL (SCREW HELD - 7MM INSERT)

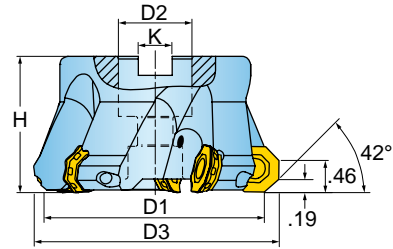

Cutter Number	D1 Nominal Diameter	D3 Overall Diameter	Number of Inserts	H Height	D2 Bore Dia.	K Keyway	Ramp Angle
5N6L-20R01	2.000	2.490	3	1.570	0.750	0.312	5.5
5N6L-30R01	3.000	3.490	5	1.750	1.000	0.375	3.5
5N6L-40R01	4.000	4.480	6	2.380	1.500	0.625	2.5
5N6L-60R01	6.000	6.480	10	2.380	1.500	0.625	1.2

Operating guidelines on [page 363](#).

INSERTS

OFCT0705AFFN-P

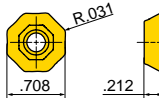

OFCT0705AFFR-W

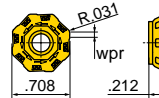
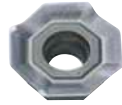

OFMT0705AFR-HR

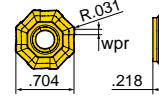

OFMT0705AFTN

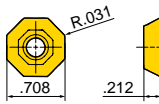

OFMW0705AFTN

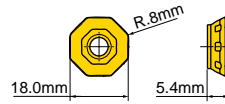

Part Number	Applications	Grade	IN1030	IN2005	IN2015	IN2030	IN2040	IN30M			
OFCT0705AFFN-P	Grd/Pol for Al - 0.031" R										●
OFCT0705AFFR-W	Wiper - 0.031" R		●								
OFMT0705AFR-HR	Positive Geometry - 0.031" R					●	●			●	
OFMT0705AFTN	Multi-Purpose - 0.031" R			●	●						
OFMW0705AFTN	Neutral Geometry - 0.031" R		●								

● = P ● = M ● = K ● = N ● = S

HARDWARE



Screw

Driver

Retention Bolt

(Optional) Coolant Bolt

5N6L-20R01	SM50-120-30	DS-T20T	SD-06-46	SD-06-89
5N6L-30R01	SM50-120-30	DS-T20T	SD-08-46	SD-08-92
5N6L-40R01	SM50-120-30	DS-T20T	SD-12-82	SD-12-99
5N6L-60R01	SM50-120-30	DS-T20T	SD-12-82	SD-12-99

45 DEGREE LEAD FACE MILL (SCREW HELD - 6MM INSERT)

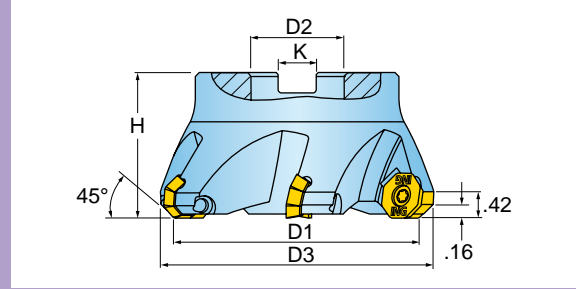

Cutter Number	D1 Effective Diameter	D3 Overall Diameter	Number of Inserts	H Height	D2 Bore Dia.	K Keyway	Ramp Angle
5N6K-25R01	2.120	2.50	4	2.000	0.750	0.312	4.4
5N6K-30R01	2.620	3.00	5	1.750	1.000	0.375	3.3
5N6K-40R01	3.620	4.00	6	2.000	1.250	0.500	2.1
5N6K-50R01	4.620	5.00	7	2.500	1.500	0.625	1.6
5N6K-60R01	5.620	6.00	8	2.500	1.500	0.625	1.3

Operating guidelines on [page 363](#).

INSERTS

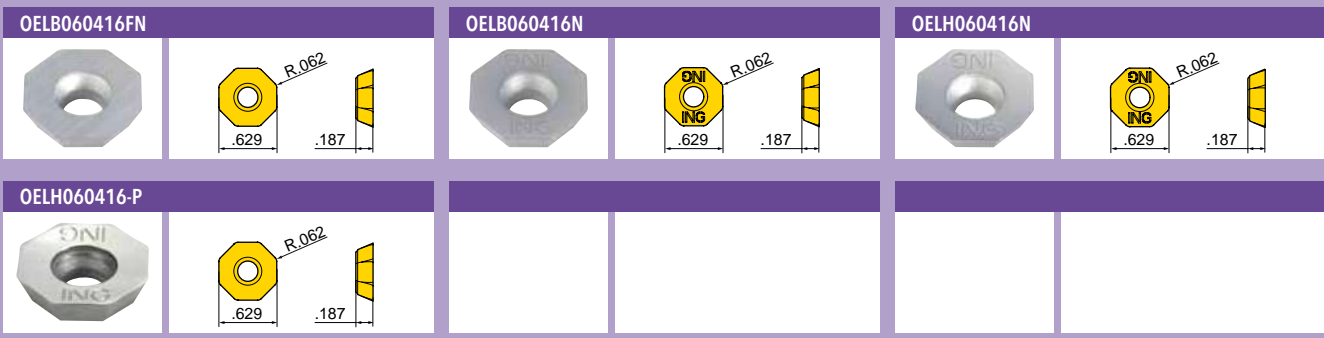



Part Number	Applications	Grade	IN1530	IN1540	IN2005	IN2030	IN2040	IN30M			
-------------	--------------	-------	--------	--------	--------	--------	--------	-------	--	--	--

OELB060416FN	Upsharp - 0.060" R										
OELB060416N	Multi-Purp./HD - 0.060" R										
OELH060416N	Multi-Purpose - 0.060" R										
OELH060416-P	Grd/Pol for Al - 0.060" R										

● = P
 ● = M
 ● = K
 ● = N
 ● = S

HARDWARE

			
	Screw	Driver	Retention Bolt
5N6K-25R01	SM50-100-10	DS-T20T	SD-06-46
5N6K-30R01	SM50-127-10	DS-T20T	SD-08-46
5N6K-40R01	SM50-127-10	DS-T20T	SD-10-47
5N6K-50R01	SM50-127-10	DS-T20T	-
5N6K-60R01	SM50-127-10	DS-T20T	-

HI-POSDEKA™ SERIES DM6G, DM5G

20 DEGREE LEAD FACE MILL WITH 10 INDEXES

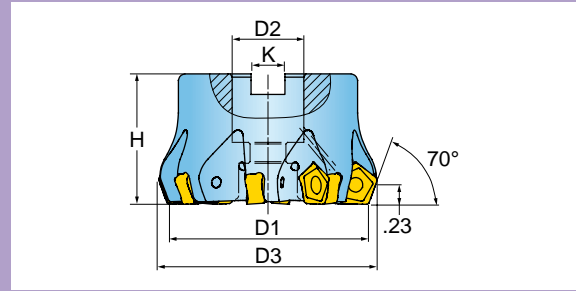

Cutter Number	D1 Effective Diameter	D3 Overall Diameter	Number of Inserts	H Height	D2 Bore Dia.	K Keyway	Bolt Circle	Coolant
DM6G-15R01	1.500	1.71	4	1.570	0.500	0.250	NA	Yes
DM5G-20R01	2.000	2.21	6	1.570	0.750	0.312	NA	Yes
DM6G-20R01	2.000	2.21	4	1.570	0.750	0.312	NA	Yes
DM5G-25R01	2.500	2.71	8	1.570	0.750	0.312	NA	Yes
DM6G-25R01	2.500	2.71	6	1.570	0.750	0.312	NA	Yes
DM5G-30R01	3.000	3.21	10	1.750	1.000	0.375	NA	Yes
DM6G-30R01	3.000	3.21	7	1.750	1.000	0.375	NA	Yes
DM5G-40R01	4.000	4.21	12	2.375	1.500	0.625	NA	Yes
DM6G-40R01	4.000	4.21	8	2.375	1.500	0.625	NA	Yes
DM5G-50R01	5.000	5.25	16	2.375	1.500	0.625	NA	No
DM6G-50R01	5.000	5.21	10	2.375	1.500	0.625	NA	Yes
DM5G-60R01	6.000	6.26	20	2.375	1.500	0.625	NA	No
DM6G-60R01	6.000	6.21	12	2.375	1.500	0.625	NA	Yes
DM6G-80R10	8.000	8.21	16	2.375	2.500	1.000	4.00	No

Operating guidelines on [page 365](#).



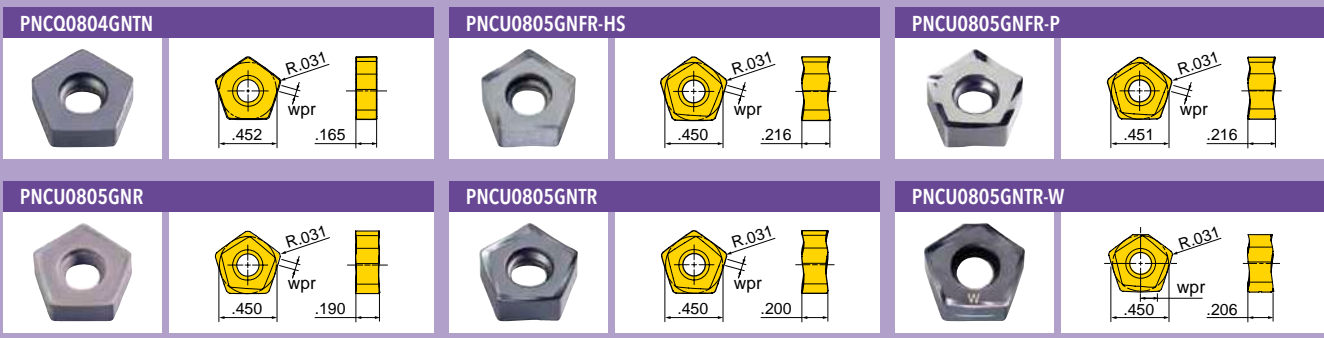

INSERTS



Part Number	Applications	Grade	IN05S	IN1030	IN2005	IN2015	IN2030	IN2505	IN70N	INDD15
			PNCQ0804GNTN	Flat Top - 0.031" R						
PNCU0805GNFR-HS	Hi-Temp/Ti - 0.031" R									
PNCU0805GNFR-P	Sharp & Polished - 0.031" R									
PNCU0805GNR	SiN for Iron - 0.031" R									
PNCU0805GNTR	Multi-Purpose - 0.031" R									
PNCU0805GNTR-W	Wiper - 0.031" R									

● = P ● = M ● = K ● = N ● = S

HARDWARE

				
	Screw	Driver	Retention Bolt	(Optional) Coolant Bolt
DM6G-15R01	SM40-100-10	DS-T15T	SD-04-86	-
DM5G-20R01	SM40-100-10	DS-T15T	SD-06-46	SD-06-89
DM6G-20R01	SM40-100-10	DS-T15T	SD-06-46	SD-06-89
DM5G-25R01	SM40-100-10	DS-T15T	SD-06-46	SD-06-89
DM6G-25R01	SM40-100-10	DS-T15T	SD-06-46	SD-06-89
DM5G-30R01	SM40-100-10	DS-T15T	SD-08-46	SD-08-92
DM6G-30R01	SM40-100-10	DS-T15T	SD-08-46	SD-08-92
DM5G-40R01	SM40-100-10	DS-T15T	SD-12-82	SD-12-99
DM6G-40R01	SM40-100-10	DS-T15T	SD-12-82	SD-12-99
DM5G-50R01	SM40-100-10	DS-T15T	-	-
DM6G-50R01	SM40-100-10	DS-T15T	SD-12-82	SD-12-99
DM5G-60R01	SM40-100-10	DS-T15T	-	-
DM6G-60R01	SM40-100-10	DS-T15T	SD-12-82	SD-12-99
DM6G-80R10	SM40-100-10	DS-T15T	-	-

20 DEGREE LEAD FACE MILL - HEAVY DUTY - WITH 10 INDEXES

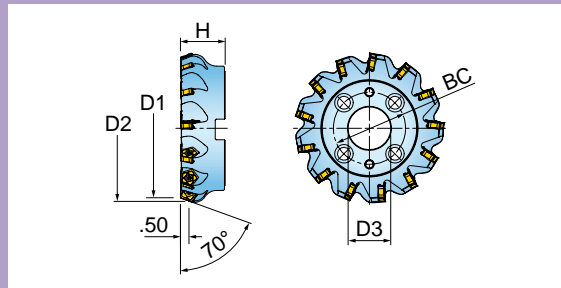

Cutter Number	D1 Effective Diameter	D2 Overall Diameter	D3 Bore Dia.	H Height	Number of Inserts	K Keyway	Bolt Circle	Coolant
DM6Q-03R01	3.000	3.44	1.000	2.375	4	0.375	NA	Yes
DM5Q-04R01	4.000	4.44	1.500	2.375	7	0.625	NA	Yes
DM6Q-04R01	4.000	4.44	1.500	2.375	5	0.625	NA	Yes
DM6Q-05R01	5.000	5.44	1.500	2.375	6	0.625	NA	Yes
DM5Q-06R01	6.000	6.44	1.500	2.375	10	0.625	NA	Yes
DM6Q-06R01	6.000	6.44	1.500	2.375	8	0.625	NA	Yes
DM5Q-08R01	8.000	8.44	2.500	2.375	13	1.000	4.00	No
DM6Q-08R01	8.000	8.44	2.500	2.375	10	1.000	4.00	No
DM6Q-10R01	10.000	10.44	2.500	2.375	12	1.000	4.00, 7.00	No
DM6Q-12R01	12.000	12.44	2.500	2.375	14	1.000	4.00, 7.00	No

Operating guidelines on [page 368](#).

INSERTS

PNCU1708GNTR (E Hone)

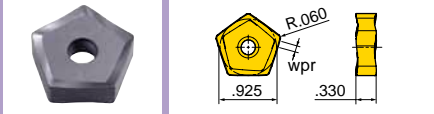

PNCU1708GNTR (J Hone)

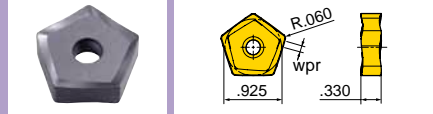

Part Number	Applications	Grade	IN2005	IN2030	IN2040	INDD15				
			PNCU1708GNTR	E Hone - Heavy-Duty - 0.060" R						
PNCU1708GNTR	J Hone - Multi-Purpose - 0.060" R									

PNCU1708GNTR	E Hone - Heavy-Duty - 0.060" R								
PNCU1708GNTR	J Hone - Multi-Purpose - 0.060" R								

● = P ● = M ● = K ● = N ● = S

HARDWARE

	Screw	Driver	Retention Bolt	(Optional) Coolant Bolt
DM6Q-03R01	SM50-130-R0	DS-T20T	SD-08-48	SD-08-92
DM5Q-04R01	SM50-130-R0	DS-T20T	SD-12-82	SD-12-99
DM6Q-04R01	SM50-130-R0	DS-T20T	SD-12-82	SD-12-99
DM6Q-05R01	SM50-130-R0	DS-T20T	SD-12-82	SD-12-99
DM5Q-06R01	SM50-130-R0	DS-T20T	SD-12-82	SD-12-99
DM6Q-06R01	SM50-130-R0	DS-T20T	SD-12-82	SD-12-99
DM5Q-08R01	SM50-130-R0	DS-T20T	-	-
DM6Q-08R01	SM50-130-R0	DS-T20T	-	-
DM6Q-10R01	SM50-130-R0	DS-T20T	-	-
DM6Q-12R01	SM50-130-R0	DS-T20T	-	-

20 DEGREE LEAD HEAVY DUTY FACE MILL W/ POCKET PROTECTION WITH 10 INDEXES

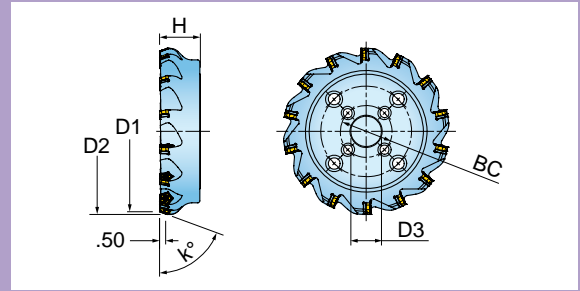

Cutter Number	D1 Effective Diameter	D2 Overall Diameter	D3 Bore Dia.	H Height	Number of Inserts	K Keyway	Bolt Circle
DM2Q-06R01	6.000	6.44	1.500	2.375	7	0.625	NA
DM2Q-08R01	8.000	8.44	2.500	2.375	8	1.000	4.00
DM2Q-10R01	10.000	10.44	2.500	2.375	10	1.000	4.00
DM2Q-12R01	12.000	12.44	2.500	2.375	12	1.000	4.00, 7.00

Operating guidelines on [page 368](#).

INSERTS

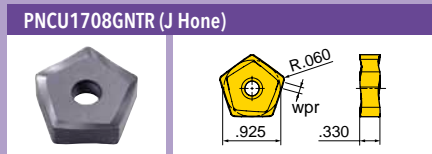
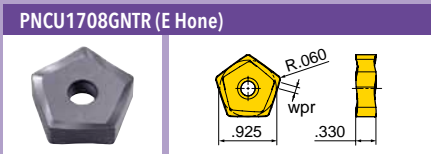

Part Number	Applications	Grade	IN2005	IN2030	IN2040	INDD15				
			PNCU1708GNTR	E Hone - Heavy-Duty - 0.060" R						
PNCU1708GNTR	J Hone - Multi-Purpose - 0.060" R									

● = P ● = M ● = K ● = N ● = S

HARDWARE

	Screw	Seat Screw	Driver	Seat	Retention Bolt	Wrench
DM2Q-06R01	SM50-130-R0	SF070R01	DS-T20T	SJ-5062	SD-12-82	DS-H05T
DM2Q-08R01	SM50-130-R0	SF070R01	DS-T20T	SJ-5062	-	DS-H05T
DM2Q-10R01	SM50-130-R0	SF070R01	DS-T20T	SJ-5062	-	DS-H05T
DM2Q-12R01	SM50-130-R0	SF070R01	DS-T20T	SJ-5062	-	DS-H05T

45 DEGREE LEAD FACE MILL



Lead Angle



Chamfer



Ramping



Pocket



Facing

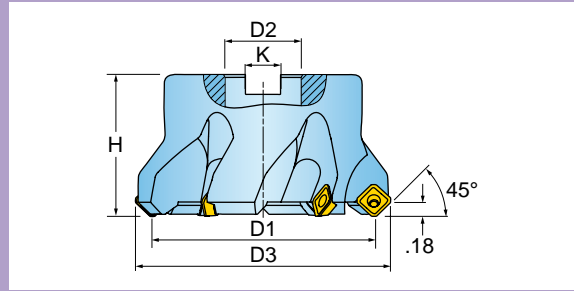

Cutter Number	D1 Effective Diameter	D3 Overall Diameter	Number of Inserts	H Height	D2 Bore Dia.	K Keyway	Ramp Angle
5N6F-12R01	1.250	1.65	4	1.570	0.500	0.250	10
5N6F-15R01	1.500	1.90	4	1.570	0.500	0.250	8
5N6F-20R01	2.000	2.40	5	1.570	0.750	0.312	6
5N6F-25R01	2.500	2.90	6	1.570	0.750	0.312	4.5
5N6F-30R01	3.000	3.40	7	2.000	1.000	0.375	3

Operating guidelines on [page 361](#).

INSERTS

SECT09T3AFFN-P

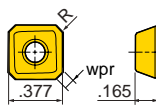

SEKT09T3AFN

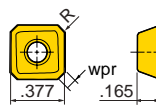
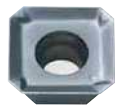

Part Number	Applications	Grade	IN1030	IN2005	IN2030	IN2040	IN30M				
SECT09T3AFFN-P	Grd/Pol for Al - 0.015" R										
SEKT09T3AFN	Multi-Purpose - 0.015" R										

● = P ● = M ● = K ● = N ● = S

HARDWARE



Screw



Driver



Retention Bolt

5N6F-12R01	SM30-082-00	DS-T09W	SD-04-85
5N6F-15R01	SM30-082-00	DS-T09W	SD-04-85
5N6F-20R01	SM30-082-00	DS-T09W	SD-06-46
5N6F-25R01	SM30-082-00	DS-T09W	SD-06-46
5N6F-30R01	SM30-082-00	DS-T09W	SD-08-47

45 DEGREE LEAD FACE MILL

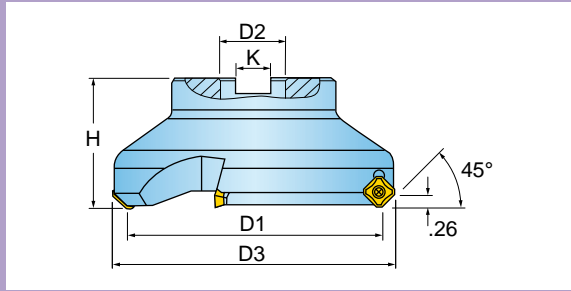

Cutter Number	D1 Nominal Diameter	D3 Overall Diameter	Number of Inserts	H Height	D2 Bore Dia.	Bolt Circle	K Keyway
5N2H-20R00	2.000	2.47	4	1.750	0.750	NA	0.312
5N2H-25R00	2.500	2.97	5	1.750	1.000	NA	0.375
5N2H-30R00	3.000	3.47	5	1.750	1.000	NA	0.375
5N2H-40R00	4.000	4.47	6	2.000	1.500	NA	0.625
5N2H-50R00	5.000	5.47	7	2.000	1.500	NA	0.625
5N2H-60R00	6.000	6.47	8	2.000	2.000	NA	0.750
5N2H-80R00	8.000	8.47	10	2.500	2.500	4.00	1.000

Operating guidelines on [page 361](#).

INSERTS

GEKT12T3AFTR-WC

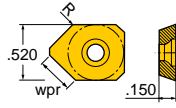

SEKT12T3AFTN-M

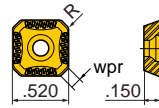

Part Number	Applications	Grade	IN1030	IN2005	IN2040	IN2510	IN2540	IN40P		
			GEKT12T3AFTR-WC	Wiper - 0.047" R						
SEKT12T3AFTN-M	Multi-Purpose - 0.043" R									

● = P ● = M ● = K ● = N ● = S

HARDWARE



	Screw	Seat Screw	Driver	Retention Bolt	Seat/Shim
5N2H-20R00	SM35-110-00	SM50-062-S0	DS-T15T	SD-06-46	SJ-0029
5N2H-25R00	SM35-110-00	SM50-062-S0	DS-T15T	-	SJ-0029
5N2H-30R00	SM35-110-00	SM50-062-S0	DS-T15T	-	SJ-0029
5N2H-40R00	SM35-110-00	SM50-062-S0	DS-T15T	-	SJ-0029
5N2H-50R00	SM35-110-00	SM50-062-S0	DS-T15T	-	SJ-0029
5N2H-60R00	SM35-110-00	SM50-062-S0	DS-T15T	-	SJ-0029
5N2H-80R00	SM35-110-00	SM50-062-S0	DS-T15T	-	SJ-0029

TETRA™ SERIES TN1N

45 DEGREE LEAD FACE MILL WITH 4 INDEXES



Lead Angle



Chamfer



Facing



Coolant

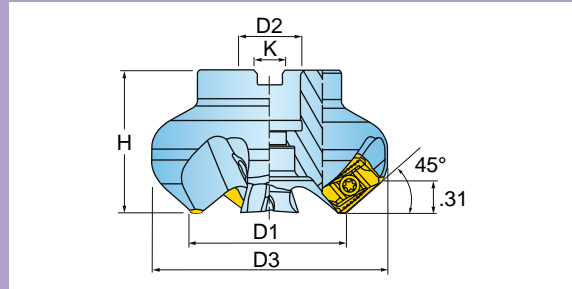

Cutter Number	D1 Nominal Diameter	D3 Overall Diameter	Number of Inserts	D2 Bore Dia.	H Height	K Keyway
TN1N-20R01	2.000	2.68	4	0.750	1.750	0.312
TN1N-30R01	3.000	3.68	5	1.000	1.750	0.375
TN1N-30R02	3.000	3.68	7	1.000	1.750	0.375
TN1N-40R01	4.000	4.67	6	1.500	2.375	0.625
TN1N-40R02	4.000	4.67	8	1.500	2.375	0.625
TN1N-60R01	6.000	6.67	10	1.500	2.375	0.625

Operating guidelines on [page 353](#).

INSERTS

ANHU1607ANR

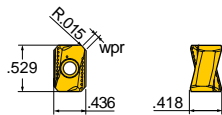

Part Number

Applications

Grade	IN2010	IN2030	IN2540						
-------	--------	--------	--------	--	--	--	--	--	--

ANHU1607ANR

Multi-Purpose - 0.015" R



● = P ● = M ● = K ● = N ● = S

HARDWARE



Screw



Driver

SM40-120-20

DS-T15T

ISOPLUS SERIES DL6H DL5H

15 DEGREE LEAD FACE MILL WITH 8 INDEXES

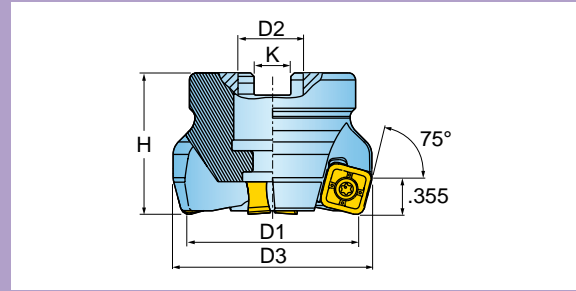

Cutter Number	D1 Nominal Diameter	D3 Overall Diameter	D2 Bore Dia.	K Keyway	H Height	Number of Inserts	Coolant
DL5H-20R01	2.000	2.30	0.750	0.312	2.000	6	Yes
DL6H-20R01	2.000	2.30	0.750	0.312	1.750	4	Yes
DL5H-25R01	2.500	2.80	1.000	0.375	1.750	8	Yes
DL6H-25R01	2.500	2.80	1.000	0.375	1.750	6	Yes
DL5H-30R01	3.000	3.30	1.000	0.375	1.750	10	No
DL6H-30R01	3.000	3.30	1.000	0.375	1.750	7	No
DL5H-40R01	4.000	4.30	1.500	0.625	2.000	12	No
DL6H-40R01	4.000	4.30	1.500	0.625	2.000	8	No
DL5H-60R01	6.000	6.30	1.500	0.625	2.000	20	No
DL6H-60R01	6.000	6.30	1.500	0.625	2.000	12	No

Operating guidelines on [page 364](#).

INSERTS

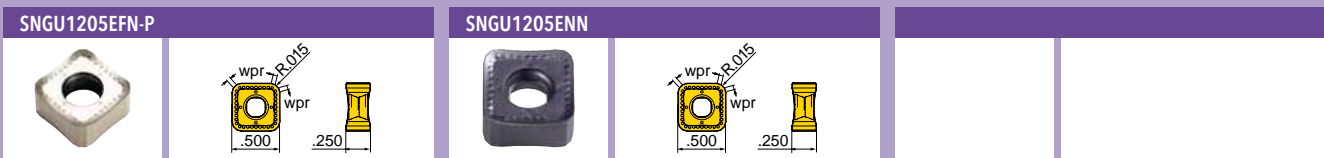





Part Number	Applications	Grade	IN10K	IN2030	IN2505	IN2510	INDD15			
-------------	--------------	-------	-------	--------	--------	--------	--------	--	--	--

SNGU1205EFN-P	Grd/Pol for Al - 0.093" R		●							
SNGU1205ENN	Multi-Purpose - 0.093" R			●	●	●	●			

● = P ● = M ● = K ● = N ● = S

HARDWARE

				
	Screw	Driver	Retention Bolt	(Optional) Coolant Bolt
DL5H-20R01	SM40-100-R0	DS-T15T	SD-06-46	SD-06-89
DL6H-20R01	SM40-100-R0	DS-T15T	SD-06-46	SD-06-89
DL5H-25R01	SM40-100-R0	DS-T15T	SD-08-46	SD-08-92
DL6H-25R01	SM40-100-R0	DS-T15T	SD-08-46	SD-08-92
DL5H-30R01	SM40-100-R0	DS-T15T	-	-
DL6H-30R01	SM40-100-R0	DS-T15T	-	-
DL5H-40R01	SM40-100-R0	DS-T15T	-	-
DL6H-40R01	SM40-100-R0	DS-T15T	-	-
DL5H-60R01	SM40-100-R0	DS-T15T	-	-
DL6H-60R01	SM40-100-R0	DS-T15T	-	-

ISOPLUS SERIES DN6H DN5H

45 DEGREE LEAD FACE MILL WITH 8 INDEXES

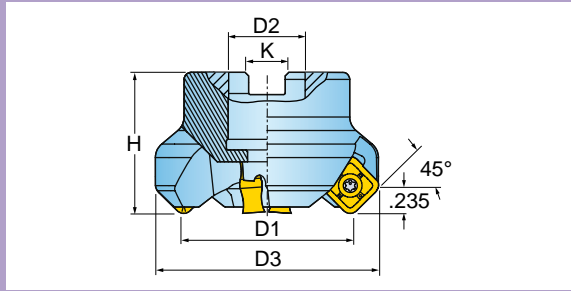

Cutter Number	D1 Nominal Diameter	D3 Overall Diameter	D2 Bore Dia.	K Keyway	H Height	Number of Inserts	Coolant
DN5H-20R01	2.000	2.57	0.750	0.312	1.750	6	Yes
DN6H-20R01	2.000	2.57	0.750	0.312	1.750	4	Yes
DN5H-25R01	2.500	3.07	1.000	0.375	1.750	8	Yes
DN6H-25R01	2.500	3.07	1.000	0.375	1.750	6	Yes
DN5H-30R01	3.000	3.57	1.000	0.375	1.750	10	Yes
DN6H-30R01	3.000	3.57	1.000	0.375	1.750	7	Yes
DN5H-40R01	4.000	4.57	1.500	0.625	2.375	12	Yes
DN6H-40R01	4.000	4.57	1.500	0.625	2.375	8	Yes
DN6H-50R01	5.000	5.57	1.500	0.625	2.375	9	Yes
DN5H-60R01	6.000	6.57	1.500	0.625	6.000	20	No
DN6H-60R01	6.000	6.57	1.500	0.625	2.000	12	No

Operating guidelines on [page 364](#).

INSERTS

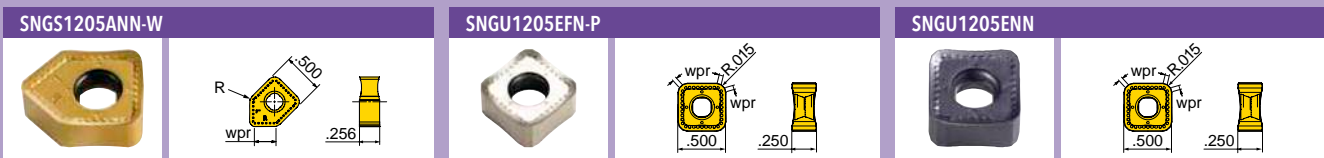





Part Number	Applications	Grade	IN10K	IN2010	IN2030	IN2505	IN2510	IN62C	INDD15		
-------------	--------------	-------	-------	--------	--------	--------	--------	-------	--------	--	--

SNGS1205ANN-W	Wiper - 0.015" R			●		●		●			
SNGU1205EFN-P	Grd/Pol for Al - 0.093" R	●									
SNGU1205ENN	Multi-Purpose - 0.093" R			●	●	●	●		●		

● = P ● = M ● = K ● = N ● = S ○ = H

HARDWARE

				
	Screw	Driver	Retention Bolt	(Optional) Coolant Bolt
DN5H-20R01	SM40-100-R0	DS-T15T	SD-06-46	SD-06-89
DN6H-20R01	SM40-100-R0	DS-T15T	SD-06-46	SD-06-89
DN5H-25R01	SM40-100-R0	DS-T15T	SD-08-46	SD-08-92
DN6H-25R01	SM40-100-R0	DS-T15T	SD-08-46	SD-08-92
DN5H-30R01	SM40-100-R0	DS-T15T	SD-08-46	SD-08-92
DN6H-30R01	SM40-100-R0	DS-T15T	SD-08-46	SD-08-92
DN5H-40R01	SM40-100-R0	DS-T15T	SD-12-82	SD-12-99
DN6H-40R01	SM40-100-R0	DS-T15T	SD-12-82	SD-12-99
DN6H-50R01	SM40-100-R0	DS-T15T	SD-12-82	SD-12-99
DN5H-60R01	SM40-100-R0	DS-T15T	-	-
DN6H-60R01	SM40-100-R0	DS-T15T	-	-



45 DEGREE LEAD FACE MILL

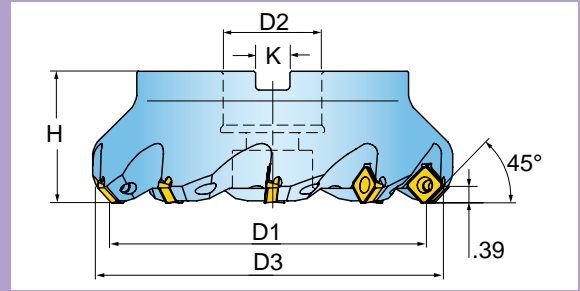

Cutter Number	D1 Effective Diameter	D3 Overall Diameter	Number of Inserts	H Height	D2 Bore Dia.	K Keyway	Ramp Angle
5N6J-20R01	2.000	2.54	4	1.750	0.750	0.312	9.5
5N6J-30R01	3.000	3.54	6	1.750	1.000	0.375	5.5
5N6J-40R01	4.000	4.54	7	2.375	1.500	0.625	4.0

Operating guidelines on [page 362](#).

INSERTS



SHLT1405APTN-HR



Part Number	Applications	Grade	IN1030	IN30M	IN40P	IN6530				
-------------	--------------	-------	--------	-------	-------	--------	--	--	--	--

SHLT1405APTN-HR Multi-Purpose - 0.010" R
● = P ● = M ● = K ● = N ● = S

HARDWARE

			
	Screw	Driver	Retention Bolt
5N6J-20R01	SM50-127-10	DS-T20T	SD-06-46
5N6J-30R01	SM50-127-10	DS-T20T	SD-08-46
5N6J-40R01	SM50-127-10	DS-T20T	SD-12-82

HIGH AXIAL SHEAR 45 DEGREE LEAD FACE MILL

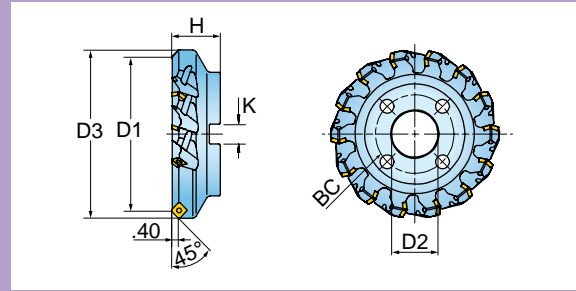

Cutter Number	D1 Effective Diameter	D3 Overall Diameter	Number of Inserts	H Height	D2 Bore Dia.	Bolt Circle	Ramp Angle	K Keyway	Coolant
5N6R-30R00	3.000	3.73	7	1.750	1.000	NA		0.375	No
5N6R-30R01	3.000	3.73	5	1.750	1.000	NA	8	0.375	No
5N6R-30R20	3.000	3.75	7	2.000	1.000	NA		0.375	Yes
5N6R-40R00	4.000	4.73	8	2.375	1.500	NA		0.625	No
5N6R-40R01	4.000	4.73	6	2.375	1.500	NA	5.7	0.625	No
5N6R-40R20	4.000	4.73	8	2.625	1.500	NA		0.625	Yes
5N6R-50R00	5.000	5.72	10	2.375	1.500	NA		0.625	No
5N6R-50R01	5.000	5.73	7	2.375	1.500	NA	4.4	0.625	No
5N6R-50R20	5.000	5.72	10	2.625	1.500	NA		0.625	Yes
5N6R-60R00	6.000	6.70	12	2.375	1.500	NA		0.625	No
5N6R-60R01	6.000	6.74	8	2.375	1.500	NA	3.6	0.625	No
5N6R-60R20	6.000	6.70	12	2.625	1.500	NA		0.625	Yes
5N6R-80R01	8.000	8.74	10	2.375	2.500	4.00		1.000	No

Operating guidelines on [page 362](#).

INSERTS

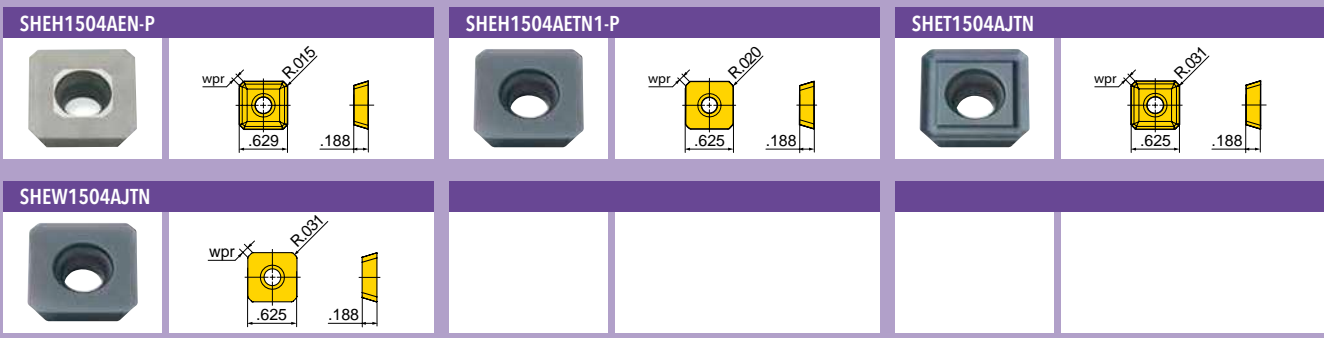

Part Number	Applications	Grade	IN1530	IN15K	IN2005	IN2010	IN2015	IN2040			
-------------	--------------	-------	--------	-------	--------	--------	--------	--------	--	--	--

SHEH1504AEN-P	Grd/Pol for Al - 0.020" R			●							
SHEH1504AETN1-P	Hi-Temp/Ti - 0.020" R				●						
SHET1504AJTN	Multi-Purpose - 0.031" R		●		●	●			●		
SHEW1504AJTN	Heavy-Duty - 0.031" R						●		●		

● = P ● = M ● = K ● = N ● = S

HARDWARE

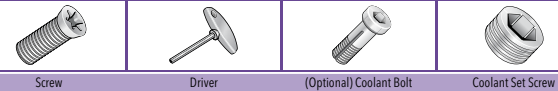

5N6R-30R00	SM50-127-10	DS-T20T	-	-
5N6R-30R01	SM50-127-10	DS-T20T	-	-
5N6R-30R20	SM50-127-10	DS-T20T	SD-08-92	SA03-48
5N6R-40R00	SM50-127-10	DS-T20T	-	-
5N6R-40R01	SM50-127-10	DS-T20T	-	-
5N6R-40R20	SM50-127-10	DS-T20T	SD-12-99	SA03-48
5N6R-50R00	SM50-127-10	DS-T20T	-	-
5N6R-50R01	SM50-127-10	DS-T20T	-	-
5N6R-50R20	SM50-127-10	DS-T20T	SD-12-99	SA03-48
5N6R-60R00	SM50-127-10	DS-T20T	-	-
5N6R-60R01	SM50-127-10	DS-T20T	-	-
5N6R-60R20	SM50-127-10	DS-T20T	SD-12-99	SA03-48
5N6R-80R01	SM50-127-10	DS-T20T	-	-

30 DEGREE LEAD FACE MILL WITH 8 INDEXES

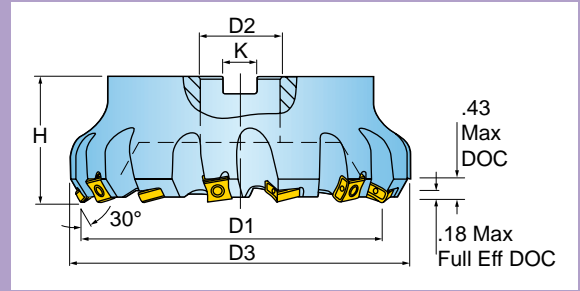

Cutter Number	D1 Effective Diameter	Number of Inserts	H Height	D2 Bore Dia.	D3 Overall Diameter	K Keyway	Bolt Circle
VM6V-02R25	2.500	6	2.375	1.000	2.97	0.375	NA
VM6V-03R01	3.000	8	2.375	1.000	3.47	0.375	NA
VM6V-04R01	4.000	10	2.375	1.500	4.47	0.625	NA
VM6V-05R01	5.000	12	2.375	1.500	5.47	0.625	NA
VM6V-06R01	6.000	14	2.375	1.500	6.47	0.625	NA
VM6V-08R01	8.000	18	2.375	2.500	8.46	1.000	4.00
VM6V-10R01	10.000	22	2.375	2.500	10.46	1.000	4.00, 7.00
VM6V-12R01	12.000	26	2.375	2.500	12.47	1.000	4.00, 7.00

Operating guidelines on [page 369](#).

INSERTS

NNE324-110

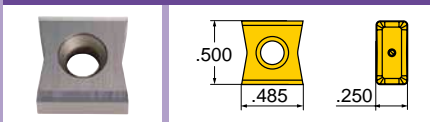

Part Number	Applications	Grade	IN2015	IN2030	IN2040	IN6515				
NNE324-110	Multi-Purpose									

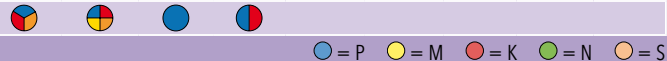

HARDWARE



	Screw	Driver	Retention Bolt
VM6V-02R25	SM40-120-20	DS-T15T	SD-08-48
VM6V-03R01	SM40-120-20	DS-T15T	-
VM6V-04R01	SM40-120-20	DS-T15T	-
VM6V-05R01	SM40-120-20	DS-T15T	-
VM6V-06R01	SM40-120-20	DS-T15T	-
VM6V-08R01	SM40-120-20	DS-T15T	-
VM6V-10R01	SM40-120-20	DS-T15T	-
VM6V-12R01	SM40-120-20	DS-T15T	-

30 DEGREE LEAD HEAVY DUTY FACE MILL WITH UP TO 8 INDEXES (4RH & 4LH)



Lead Angle



Chamfer



Facing

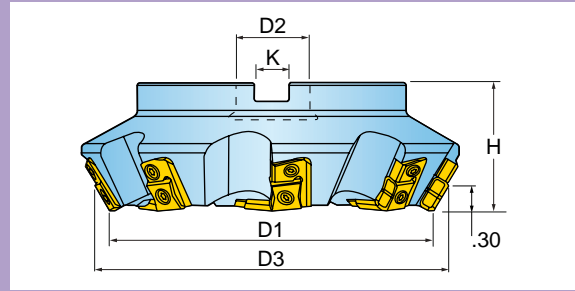
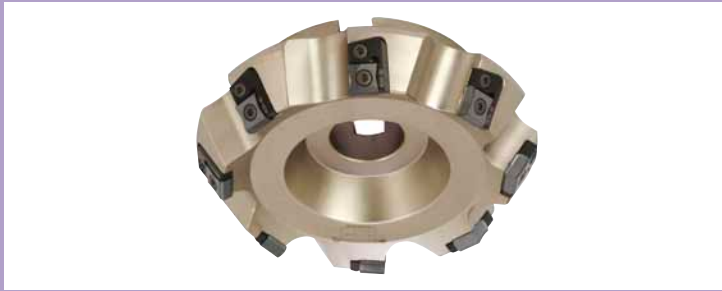

Cutter Number	D1 Effective Diameter	D2 Bore Size	D3 Overall Diameter	K Keyway	H Height	Number of Inserts
VM2N-03L01	3.000	1.000	3.55	0.375	2.375	5
VM2N-03R01	3.000	1.000	3.55	0.375	2.375	5
VM2N-04L01	4.000	1.500	4.55	0.625	2.375	6
VM2N-04R01	4.000	1.500	4.55	0.625	2.375	6
VM2N-06L01	6.000	1.500	6.55	0.625	2.375	8
VM2N-06R01	6.000	1.500	6.55	0.625	2.375	8
VM2N-08L01	8.000	2.500	8.55	1.000	2.375	10
VM2N-08R01	8.000	2.500	8.55	1.000	2.375	10

Operating guidelines on [page 366](#).

INSERTS

NNE425-030

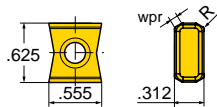

--	--	--	--	--	--

Part Number	Applications	Grade	IN2005	IN6510						
-------------	--------------	-------	--------	--------	--	--	--	--	--	--

NNE425-030 Multi-Purpose - 0.005" R w/.080" Wiper



● = P ● = M ● = K ● = N ● = S

HARDWARE



Screw



Driver



Retention Bolt



L-Nest Screw



L-Nest

VM2N-03L01	SM50-127-10	DS-T20T	SD-08-47	SM50-127-10	NE04-80
VM2N-03R01	SM50-127-10	DS-T20T	SD-08-47	SM50-127-10	NE04-80
VM2N-04L01	SM50-127-10	DS-T20T	-	SM50-127-10	NE04-80
VM2N-04R01	SM50-127-10	DS-T20T	-	SM50-127-10	NE04-80
VM2N-06L01	SM50-127-10	DS-T20T	-	SM50-127-10	NE04-80
VM2N-06R01	SM50-127-10	DS-T20T	-	SM50-127-10	NE04-80
VM2N-08L01	SM50-127-10	DS-T20T	-	SM50-127-10	NE04-80
VM2N-08R01	SM50-127-10	DS-T20T	-	SM50-127-10	NE04-80

45 DEGREE LEAD FACE MILL WITH 4 INDEXES

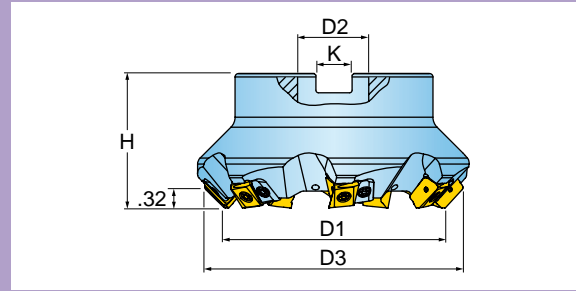

Cutter Number	D1 Effective Diameter	Number of Inserts	H Height	D2 Bore Dia.	D3 Max. Dia.	K Keyway	Coolant
SN2J-03R01	3.000	5	2.375	1.000	3.68	0.375	Yes
SN6J-03R01	3.000	7	2.375	1.000	3.68	0.375	Yes
SN2J-04R01	4.000	7	2.375	1.500	4.68	0.625	Yes
SN6J-04R01	4.000	9	2.375	1.500	4.68	0.625	Yes
SN2J-06R01	6.000	10	2.375	1.500	6.68	0.625	No
SN6J-06R01	6.000	12	2.375	1.500	6.68	0.625	No

Operating guidelines on [page 356](#).

INSERTS

DGE324R045

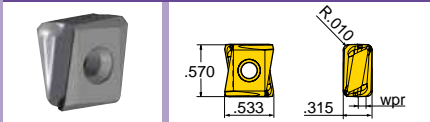

DGM324R045

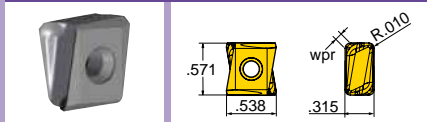

Part Number	Applications	Grade	IN2005	IN2015	IN2030	IN2040	IN6515				
-------------	--------------	-------	--------	--------	--------	--------	--------	--	--	--	--

DGE324R045 SS/Hi-Temp/Ti - 0.010" R w/.060" Wiper

DGM324R045 Multi-Purpose - 0.010" R w/.060" Wiper

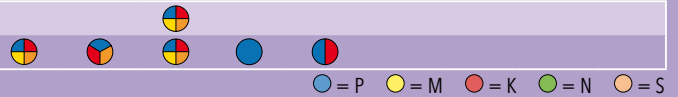

HARDWARE



	Screw	Driver	Anvil Screw	Anvil	Retention Bolt	(Optional) Coolant Bolt
SN2J-03R01	SM40-143-H0	DS-T15T	SM40-143-H0	PAR0646	SD-08-48	-
SN6J-03R01	SM40-143-H0	DS-T15T	SM40-143-H0	PAR0646	SD-08-48	-
SN2J-04R01	SM40-143-H0	DS-T15T	SM40-143-H0	PAR0646	SD-12-82	SD-12-99
SN6J-04R01	SM40-143-H0	DS-T15T	SM40-143-H0	PAR0646	SD-12-82	SD-12-99
SN2J-06R01	SM40-143-H0	DS-T15T	SM40-143-H0	PAR0646	-	-
SN6J-06R01	SM40-143-H0	DS-T15T	SM40-143-H0	PAR0646	-	-

45 DEGREE LEAD HEAVY FEED FACE MILL WITH 4 INDEXES



Lead Angle



Chamfer



Facing

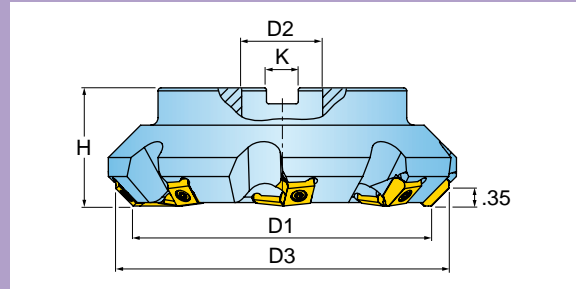
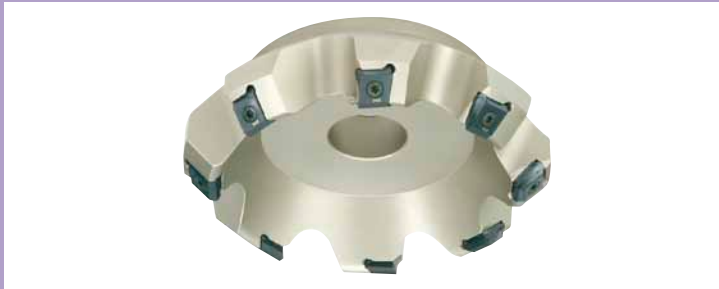

Cutter Number	D1 Effective Diameter	Number of Inserts	H Height	D2 Bore Dia.	D3 Max. Dia.	Bolt Circle	K Keyway
SN6N-03R01	3.000	5	2.375	1.000	3.66	NA	0.375
SN6N-04R01	4.000	6	2.375	1.500	4.69	NA	0.625
SN6N-05R01	5.000	7	2.375	1.500	5.69	NA	0.625
SN6N-06R01	6.000	8	2.375	1.500	6.70	NA	0.625
SN6N-08R01	8.000	10	2.375	2.500	8.70	4.00	1.000
SN6N-10R01	10.000	12	2.375	2.500	10.70	4.00, 7.00	1.000
SN6N-12R01	12.000	14	2.375	2.500	12.70	4.00, 7.00	1.000

Operating guidelines on [page 366](#).

INSERTS

DPM434R045

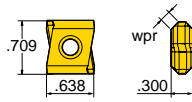

DPM435R045

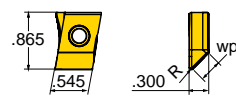

Part Number	Applications	Grade	IN2005	IN2015	IN2030	IN2040	IN2530				
			DPM434R045	Multi-Purpose w/.150" Wiper							
DPM435R045	Wiper - 0.010" R w/.350" Wiper										

● = P ● = M ● = K ● = N ● = S

HARDWARE



Screw



Driver

SM50-160-10

DS-T20T

45 DEGREE LEAD HEAVY FEED FACE MILL WITH 4 INDEXES

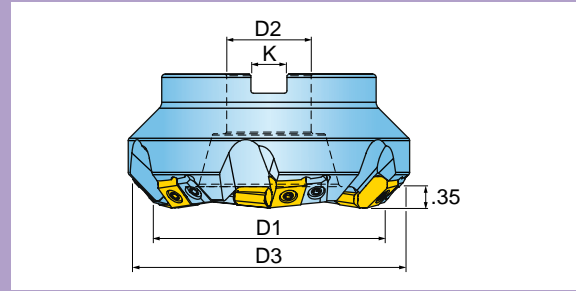

Cutter Number	D1 Effective Diameter	Insert Series	Number of Inserts	H Height	D2 Bore Dia.	K Keyway	D3 Max. Dia.	Bolt Circle
SN2N-04A01	4.000	DPM	6	2.375	1.500	0.625	4.69	NA
SN2N-04A02	4.000	DNM	6	2.375	1.500	0.625	4.69	NA
SN2N-05A01	5.000	DPM	7	2.375	1.500	0.625	5.69	NA
SN2N-05A02	5.000	DNM	7	2.375	1.500	0.625	5.69	NA
SN2N-06A01	6.000	DPM	8	2.375	1.500	0.625	6.70	NA
SN2N-06A02	6.000	DNM	8	2.375	1.500	0.625	6.70	NA
SN2N-08A01	8.000	DPM	10	2.375	2.500	1.000	8.70	4.00
SN2N-08A02	8.000	DNM	10	2.375	2.500	1.000	8.70	4.00
SN2N-10A01	10.000	DPM	12	2.375	2.500	1.000	10.70	4.00, 7.00
SN2N-10A02	10.000	DNM	12	2.375	2.500	1.000	10.70	4.00, 7.00
SN2N-12A01	12.000	DPM	14	2.375	2.500	1.000	12.70	4.00, 7.00
SN2N-12A02	12.000	DNM	14	2.375	2.500	1.000	12.70	4.00, 7.00

Operating guidelines on [page 366](#).

INSERTS

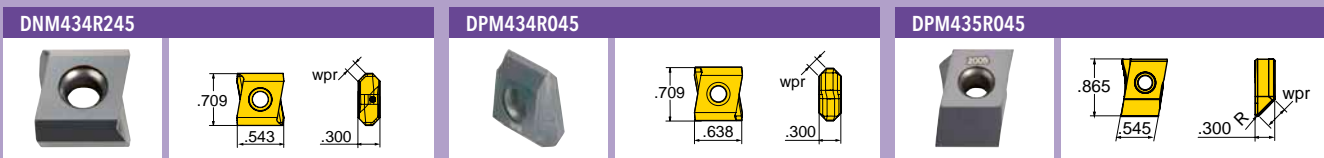

Part Number	Applications	Grade	IN2005	IN2015	IN2030	IN2040	IN2530			
-------------	--------------	-------	--------	--------	--------	--------	--------	--	--	--

DNM434R245	Heavy-Duty w/.150" Wiper									
DPM434R045	Multi-Purpose w/.150" Wiper									
DPM435R045*	Wiper - 0.010" R w/.350" Wiper									

*Use with PAR0628 only.

= P = M = K = N = S

HARDWARE

	Screw	Driver	Anvil Screw	Anvil
SN2N-04A01	SM50-160-10	DS-T20T	SM50-160-10	PAR0628
SN2N-04A02	SM50-160-10	DS-T20T	SM50-160-10	PAR0636
SN2N-05A01	SM50-160-10	DS-T20T	SM50-160-10	PAR0628
SN2N-05A02	SM50-160-10	DS-T20T	SM50-160-10	PAR0636
SN2N-06A01	SM50-160-10	DS-T20T	SM50-160-10	PAR0628
SN2N-06A02	SM50-160-10	DS-T20T	SM50-160-10	PAR0636
SN2N-08A01	SM50-160-10	DS-T20T	SM50-160-10	PAR0628
SN2N-08A02	SM50-160-10	DS-T20T	SM50-160-10	PAR0636
SN2N-10A01	SM50-160-10	DS-T20T	SM50-160-10	PAR0628
SN2N-10A02	SM50-160-10	DS-T20T	SM50-160-10	PAR0636
SN2N-12A01	SM50-160-10	DS-T20T	SM50-160-10	PAR0628
SN2N-12A02	SM50-160-10	DS-T20T	SM50-160-10	PAR0636

MULTIPLE GEOMETRY CARTRIDGE FACE MILL - 4W2A

CARTRIDGES VARY BY INSERT TYPE

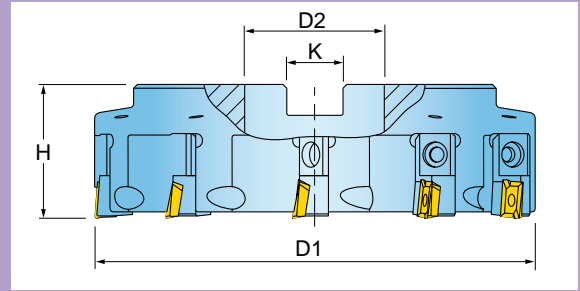
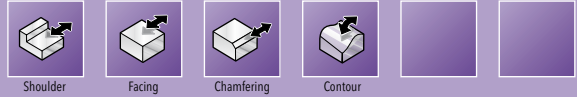

Cutter Number	D ₁ Nominal Diameter	# of Inserts	H Height	D ₂ Bore Diameter	Bolt Circle	Weight With Cartridges	K Keyway
4W2A-04R01	4.00	6	2.460	1.500	-	4.11 lbs.	.63
4W2A-06R01	6.00	8	2.460	1.500	-	10.13 lbs.	.63
4W2A-08R01	8.00	10	2.460	2.500	4.00	17.11 lbs.	1.00
4W2A-10R01	10.00	12	2.460	2.500	4.00	28.7 lbs.	1.00
4W2A-12R01	12.00	14	2.460	2.500	4.00, 7.00	39.15 lbs.	1.00

ORDERING INSTRUCTIONS

1. Select cutter body.
2. Select cartridge.
3. Select insert series and features.
4. Assemble cartridge and insert to master cutter body.
5. For operating guidelines, see referenced insert series on facing page.

HARDWARE



Screw



Driver



Axial Adjustable Screw



Driver

SD060-01

DS-H05T (5mm hex)

SA04-42

DS-H03T (3mm hex)

MULTIPLE GEOMETRY CARTRIDGE FACE MILL - 4W2A

CARTRIDGES

Type	Cartridge Number	Drawing	Insert Series (*Cutter Style)	Insert Screw
Hi•Pos+	52E-11R01		AOMT18 (*2J1E Style)	SM40-120-20
Hi•Pos Quad	52J-11R01		SHE15 (*5N6R Style)	SM50-127-10
V•Max	5VV-11R02		NNE324 (*VK6V Style)	SM40-120-20
.750 Form•Master	55M-11R01		RPLB19 (*5W6M Style)	SM50-127-10
Hi•Pos Deka	55H-11R07		PNCU08 (*DM6G Style)	SM40-100-10
.750 Form•Master Wave	55M-11R04		RCLB19 (*5W6N Style)	SM60-150-00
Power•Feed+	55H-11R08		UNEU12 (*DG6H Style)	SM40-120-20

* See cutter series for complete insert selections and operating guideline pages.

45 DEGREE LEAD HEAVY DUTY FACE MILL WITH 4 INDEXES

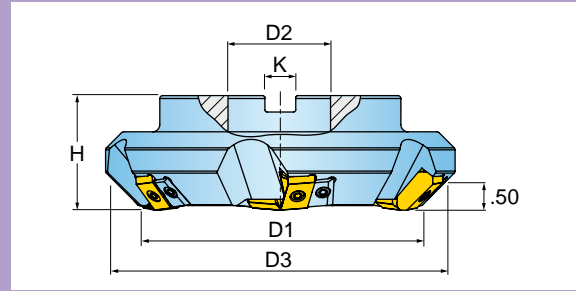

Cutter Number	D1 Effective Diameter	Number of Inserts	H Height	D2 Bore Dia.	D3 Max. Dia.	Bolt Circle	K Keyway
SN2R-04R01	4.000	5	2.375	1.500	5.07	NA	0.625
SN2R-06R01	6.000	6	2.375	1.500	7.07	NA	0.625
SN2R-08R01	8.000	8	2.375	2.500	9.07	4.00	1.000
SN2R-10R01	10.000	10	2.375	2.500	11.07	4.00, 7.00	1.000
SN2R-12R01	12.000	12	2.375	2.500	13.07	4.00, 7.00	1.000

Operating guidelines on [page 365](#).

INSERTS

DPM436R045

Part Number	Applications	Grade	IN2005	IN2015	IN2030	IN2040	IN2530			
-------------	--------------	-------	--------	--------	--------	--------	--------	--	--	--

DPM436R045 Multi-Purpose - 0.010" R w/.150" Wiper

● = P ● = M ● = K ● = N ● = S

HARDWARE

	Screw	Driver	Anvil	Anvil Screw
SN2R-04R01	SM50-160-10	DS-T20T	PAR0629	SM50-160-10
SN2R-06R01	SM50-160-10	DS-T20T	PAR0629	SM50-160-10
SN2R-08R01	SM50-160-10	DS-T20T	PAR0629	SM50-160-10
SN2R-10R01	SM50-160-10	DS-T20T	PAR0629	SM50-160-10
SN2R-12R01	SM50-160-10	DS-T20T	PAR0629	SM50-160-10



Ingersoll

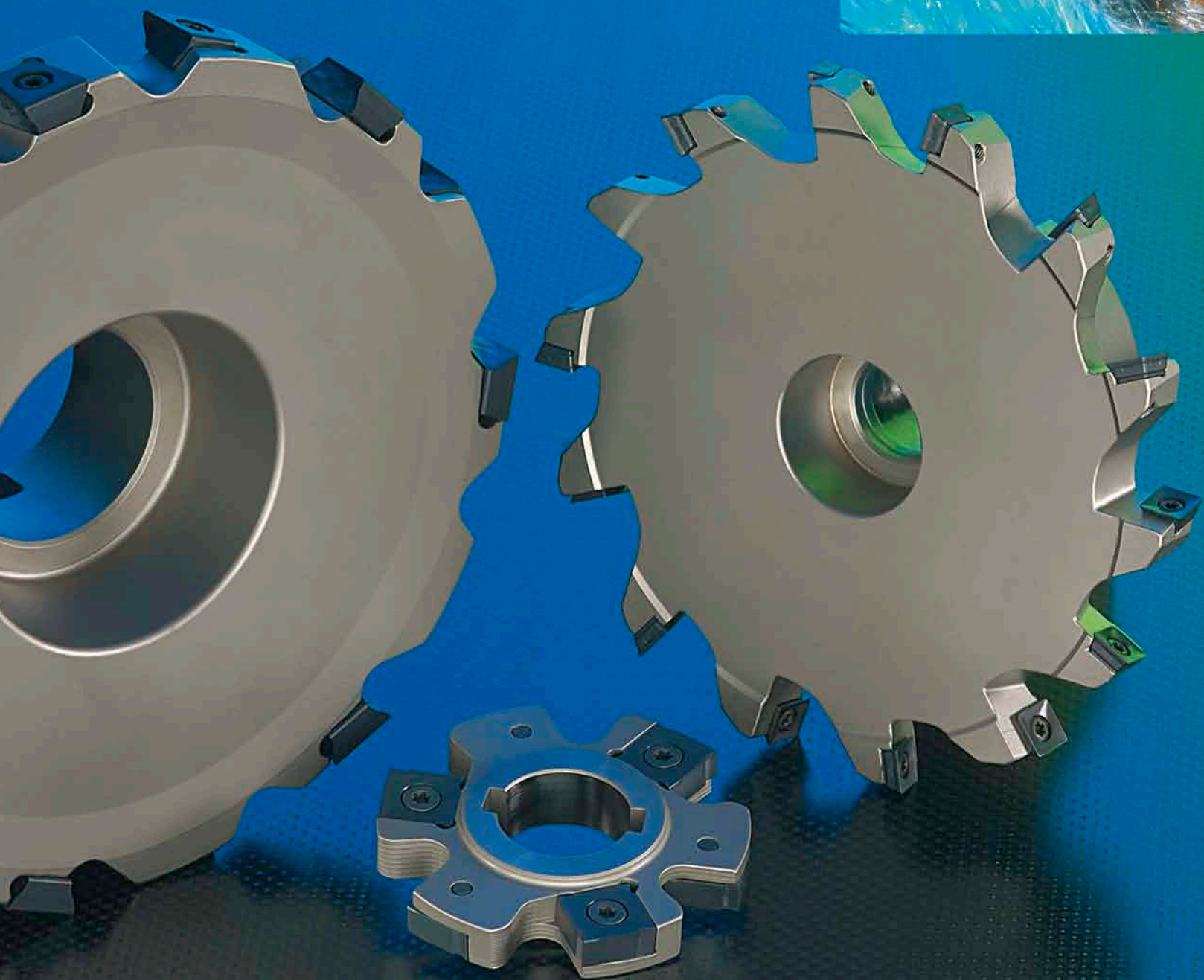

CUTTING TOOLS

SLOTTING MILLS.

Cutting Tools

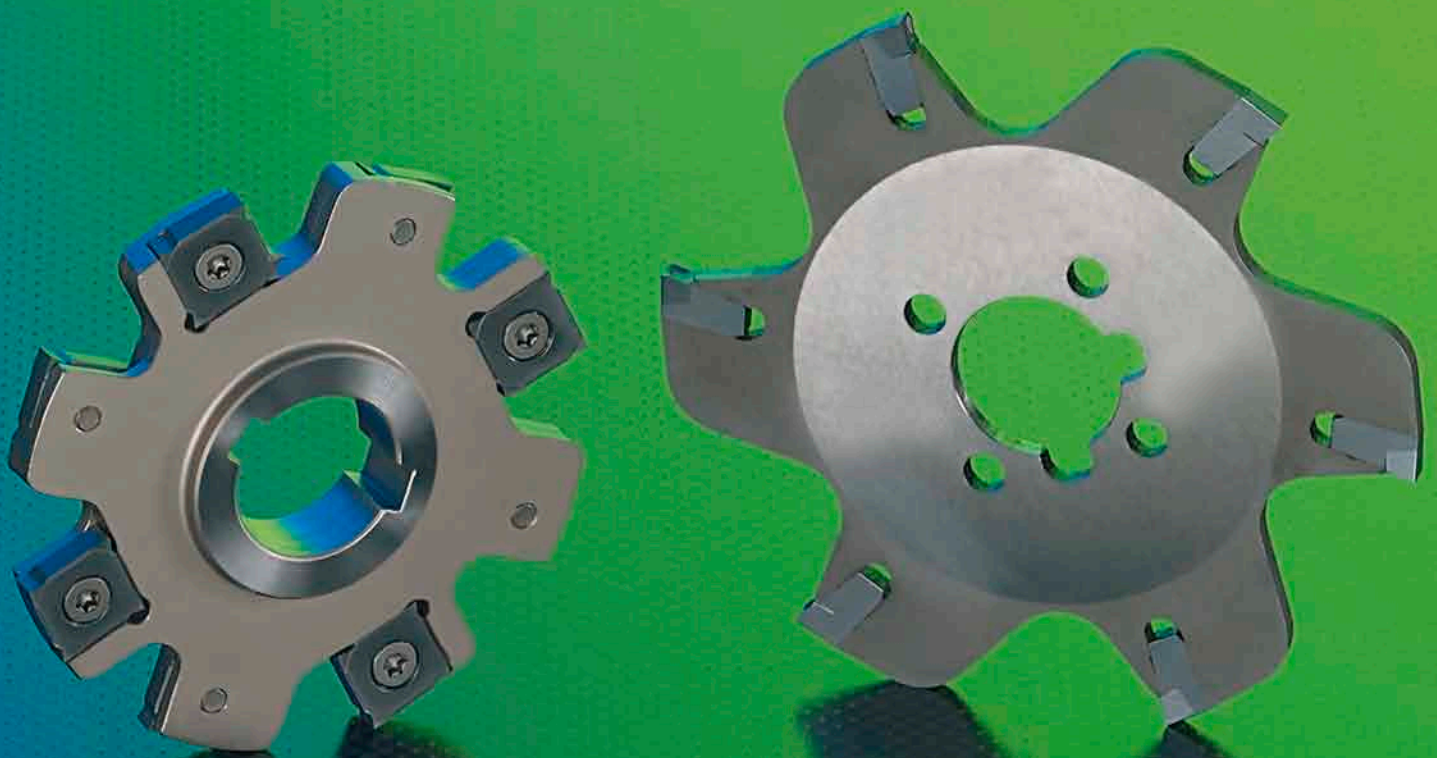

Member IMC Group
Ingersoll
Cutting Tools

SLOTTING MILLS.

	Diameter Range	Width	Description	Series	Page
	4.000 - 10.000	.110 - .220	TOCLAMP^{ULTRA} Drive Flange Slotter	TSC*K	206
	3.000 - 4.000	.063 - .079	TOCLAMP^{ULTRA} Integral Hub	TSC*A	207
	3.000 - 8.000	.187 - .312	SLOT-MAX Medium Duty Slotter	38L5 (Axial Drive)	208
	2.500 - 5.000	.156 - .312	SLOT-MAX Medium Duty Slotter	38L5 (Radial Drive)	210
	4.000 - 8.000	.375 - .500	V-MAX Medium Density Face Mount Slotter	3VL5V (Axial Drive)	212
	4.000 - 8.000	.375 - .500	V-MAX Medium Density Face Mount Slotter	3VL5V (Radial Drive)	213
	4.000 - 10.000	.625 - 1.000	S-MAX Heavy-Duty Axial Drive Slotter	3SJ6 (Axial Drive)	214
	4.000 - 10.000	.625 - 1.000	S-MAX Heavy-Duty Radial Drive Slotter	3SJ6 (Radial Drive)	216

TOCLAMP^{ULTRA}™ SERIES TSC*K (DRIVE FLANGE)

THIN SLOTTERS



Slotting

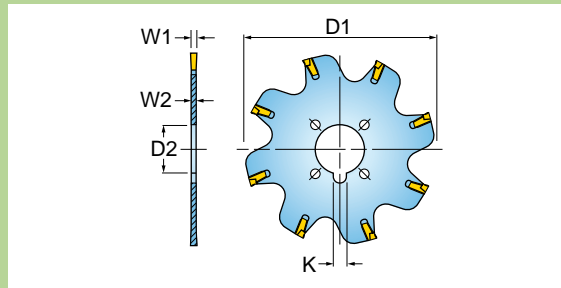

Cutter Number	W1 Cutter Width	D1 Nom. Dia.	D2 Bore Dia.	K Keyway	W2 Hub Width	Total No. of Inserts	No. of Effective Inserts	Max. Radial DOC	Max. RPM
TSC4.1221.000K	0.110	4.000	1.000	0.250	0.094	6	6	1.08	780
TSC4.1881.000K	0.179	4.000	1.000	0.250	0.157	6	6	1.08	780
TSC5.1221.250K	0.110	5.000	1.250	0.312	0.094	8	8	1.40	630
TSC5.1881.250K	0.179	5.000	1.250	0.312	0.157	8	8	1.40	630
TSC6.1221.500K	0.110	6.000	1.500	0.375	0.094	10	10	1.41	520
TSC6.1881.500K	0.179	6.000	1.500	0.375	0.157	10	10	1.41	520
TSC6.2361.500K	0.220	6.000	1.500	0.375	0.203	10	10	1.41	520
TSC8.1221.500K	0.110	8.000	1.500	0.375	0.094	14	14	2.41	390
TSC8.1881.500K	0.179	8.000	1.500	0.375	0.157	14	14	2.41	390
TSC8.2361.500K	0.220	8.000	1.500	0.375	0.203	14	14	2.41	390
TSC10.2361.500K	0.220	10.000	1.500	0.375	0.203	18	18	3.41	310

See T-Clamp Ultra Turning section for insert series TIMC, TIMJ, TIPV, [pages 1292 - 1297](#).
Operating guidelines on [page 380](#).

HARDWARE



Insert Extractor



Drive Flange

TSC4.1221.000K	DR-0032	FL-0002
TSC4.1881.000K	DR-0031	FL-0002
TSC5.1221.250K	DR-0032	FL-0003
TSC5.1881.250K	DR-0031	FL-0003
TSC6.1221.500K	DR-0032	FL-0004
TSC6.1881.500K	DR-0031	FL-0004
TSC6.2361.500K	DR-0031	FL-0004
TSC8.1221.500K	DR-0032	FL-0004
TSC8.1881.500K	DR-0031	FL-0004
TSC8.2361.500K	DR-0031	FL-0004
TSC10.2361.500K	DR-0031	FL-0004

DRIVE FLANGE

Bore	Part Number	Thickness	Overall Dia.	Keyway
1.000	FL-0002	.390	1.81	.25
1.250	FL-0003	.390	2.16	.32
1.500	FL-0004	.470	3.15	.38

THIN SLOTTERS



Slotting

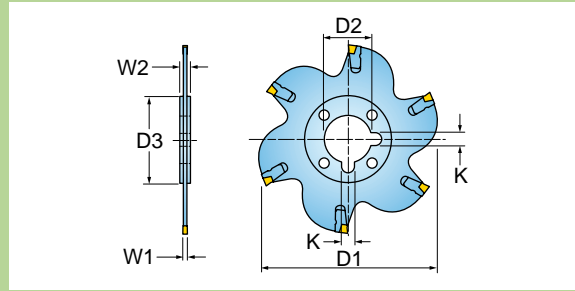
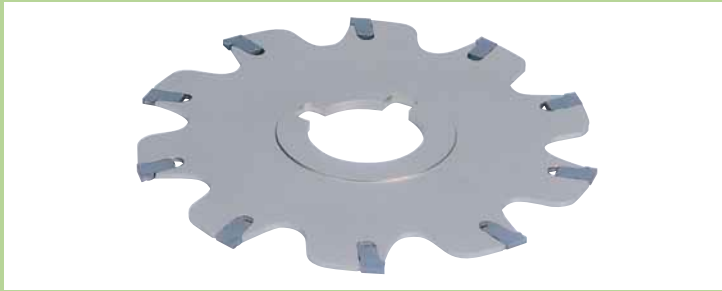

Cutter Number	W1 Cutter Width	D1 Nom. Dia.	D2 Bore Dia.	K Keyway	W2 Hub Width	D3 Hub Diameter	Total Number of Inserts	Number of Effective Inserts	Max. Radial DOC	Max. RPM
TSC3.0631.000A	0.063	3.000	1.000	0.250	0.094	1.54	8	8	0.71	1050
TSC3.0871.000A	0.079	3.000	1.000	0.250	0.094	1.54	8	8	0.71	1050
TSC4.0631.000A	0.063	4.000	1.000	0.250	0.094	1.54	10	10	1.21	780

See T-Clamp Ultra Turning section for insert series TIMC, TIMJ, TIPV, [pages 1292 - 1297](#).
Operating guidelines on [page 380](#).

HARDWARE



Insert Extractor

DR-0032

MEDIUM-DUTY SLOTTERS



Slotting

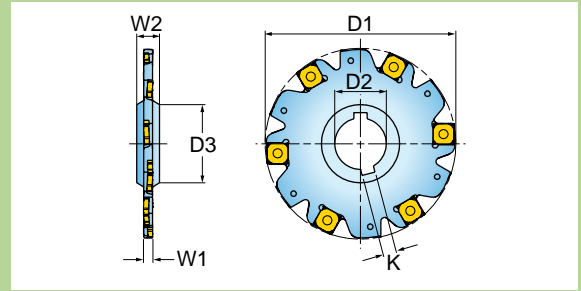

Cutter Number	W1 Cutter Width	D1 Nom. Dia.	D2 Bore Dia.	W2 Hub Width	D3 Hub Diameter	K Keyway	Total No. of Inserts	No. of Effective Inserts	Insert Series
38L5G-03018AF-01	0.187	3.000	1.000	0.375	1.56	0.250	10	5	SDE-31-001
38L5G-04018AF-01	0.187	4.000	1.000	0.500	1.75	0.250	12	6	SDE-31-001
38L5H-04025AF-01	0.250	4.000	1.000	0.500	1.75	0.250	10	5	SDE-42-001
38L5G-05018AG-01	0.187	5.000	1.250	0.500	1.87	0.312	14	7	SDE-31-001
38L5H-05025AG-01	0.250	5.000	1.250	0.500	1.87	0.312	12	6	SDE-42-001
38L5H-05031AG-01	0.312	5.000	1.250	0.500	1.87	0.312	12	6	SDE-42-002
38L5G-06015AG-01	0.156	6.000	1.250	0.500	1.87	0.312	18	9	SDE-31-001
38L5G-06018AG-01	0.187	6.000	1.250	0.500	1.87	0.312	18	9	SDE-31-002
38L5H-06025AG-01	0.250	6.000	1.250	0.500	1.87	0.312	14	7	SDE-42-001
38L5H-06031AG-01	0.312	6.000	1.250	0.500	1.87	0.312	14	7	SDE-42-002
38L5H-08025AH-01	0.250	8.000	1.500	0.500	2.75	0.375	18	9	SDE-42-001
38L5H-08031AH-01	0.312	8.000	1.500	0.500	2.75	0.375	18	9	SDE-42-003

Operating guidelines on [page 380](#).

INSERTS

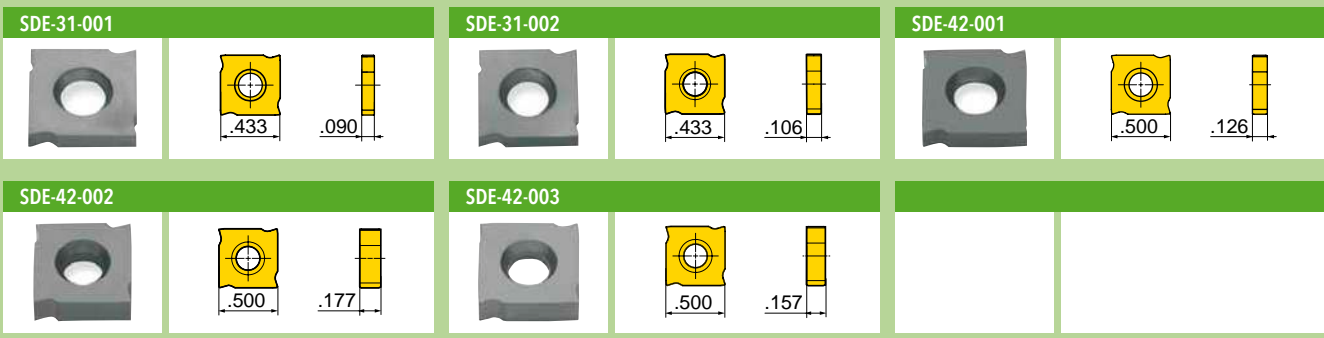

Part Number	Applications	Grade	IN1030	IN15K	IN2040	IN30M					
			SDE-31-001	Multi-Purpose - 0.006" Chamfer x 20 deg.							
SDE-31-002	Multi-Purpose - 0.006" Chamfer x 20 deg.										
SDE-42-001	Multi-Purpose - 0.012" Chamfer x 17 deg.										
SDE-42-002	Multi-Purpose - 0.012" Chamfer x 17 deg.										
SDE-42-003	Multi-Purpose - 0.012" Chamfer x 17 deg.										

= P = M = K = N = S

HARDWARE



	Screw	Driver	Driver
38L5G-03018AF-01	SM35-042-50	-	DS-T09W
38L5G-04018AF-01	SM35-042-50	-	DS-T09W
38L5H-04025AF-01	SM40-050-50	DS-T15T	-
38L5G-05018AG-01	SM35-042-50	-	DS-T09W
38L5H-05025AG-01	SM40-050-50	DS-T15T	-
38L5H-05031AG-01	SM40-060-50	DS-T15T	-
38L5G-06015AG-01	SM35-034-50	-	DS-T09W
38L5G-06018AG-01	SM35-042-50	-	DS-T09W
38L5H-06025AG-01	SM40-050-50	DS-T15T	-
38L5H-06031AG-01	SM40-060-50	DS-T15T	-
38L5H-08025AH-01	SM40-050-50	DS-T15T	-
38L5H-08031AH-01	SM40-060-50	DS-T15T	-

SLOT^oMAX™ SERIES 38L5 (RADIAL DRIVE)

MEDIUM-DUTY SLOTTERS

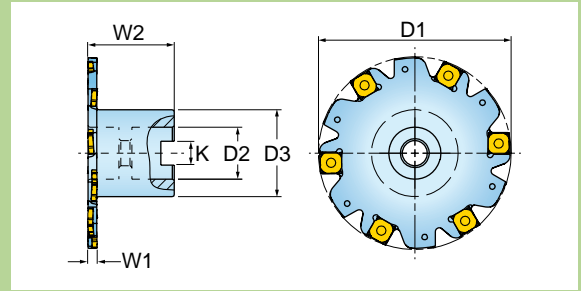

Cutter Number	W1 Cutter Width	D1 Nom. Dia.	D2 Bore Dia.	W2 Hub Width	D3 Hub Diameter	K Keyway	Total No. of Inserts	No. of Effective Inserts	Insert Series
38L5G-02015D1R25	0.156	2.500	0.750	1.370	1.18	0.312	8	4	SDE-31-001
38L5G-02018D1R25	0.187	2.500	0.750	1.370	1.18	0.312	8	4	SDE-31-002
38L5H-02025D1R25	0.250	2.500	0.750	1.500	1.50	0.312	6	3	SDE-42-001
38L5G-03015D1R01	0.156	3.000	0.750	1.500	1.50	0.312	10	5	SDE-31-001
38L5G-03018D1R01	0.187	3.000	0.750	1.500	1.50	0.312	10	5	SDE-31-002
38L5H-03025D1R01	0.250	3.000	0.750	1.500	1.50	0.312	8	4	SDE-42-002
38L5G-04015D3R01	0.156	4.000	1.000	1.500	1.75	0.375	12	6	SDE-31-001
38L5G-04018D3R01	0.187	4.000	1.000	1.500	1.75	0.375	12	6	SDE-31-002
38L5H-04025D3R01	0.250	4.000	1.000	1.500	1.75	0.375	10	5	SDE-42-001
38L5H-04031D3R01	0.312	4.000	1.000	1.500	1.75	0.375	10	5	SDE-42-002
38L5G-05015D3R01	0.156	5.000	1.000	1.500	2.75	0.375	14	7	SDE-31-001
38L5G-05018D3R01	0.187	5.000	1.000	1.500	2.75	0.375	14	7	SDE-31-002
38L5H-05025D3R01	0.250	5.000	1.000	1.500	2.75	0.375	12	6	SDE-42-001
38L5H-05031D3R01	0.312	5.000	1.000	1.500	2.75	0.375	12	6	SDE-42-002

Operating guidelines on [page 380](#).

INSERTS

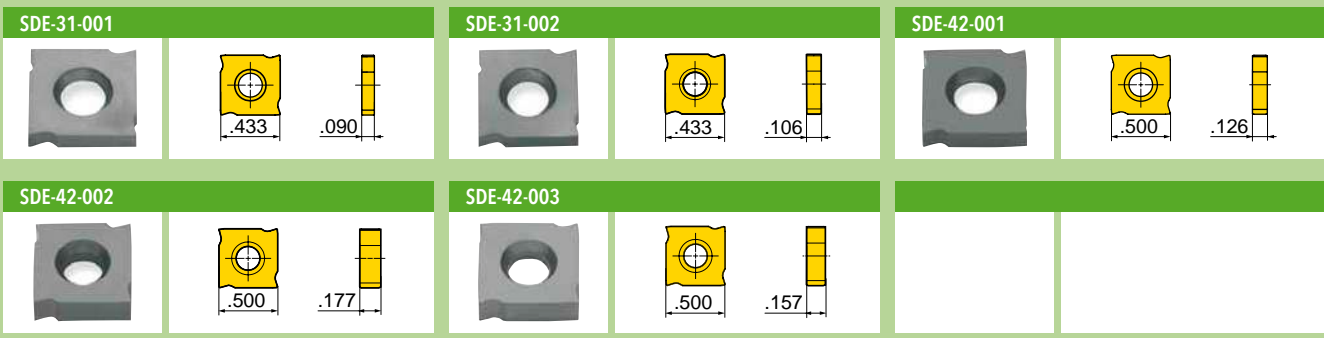

Part Number	Applications	Grade	IN1030	IN15K	IN2040	IN30M				
			SDE-31-001	Multi-Purpose - 0.006" Chamfer x 20 deg.						
SDE-31-002	Multi-Purpose - 0.006" Chamfer x 20 deg.									
SDE-42-001	Multi-Purpose - 0.012" Chamfer x 17 deg.									
SDE-42-002	Multi-Purpose - 0.012" Chamfer x 17 deg.									
SDE-42-003	Multi-Purpose - 0.012" Chamfer x 17 deg.									

= P
 = M
 = K
 = N
 = S

HARDWARE

	Screw	Driver	Driver	Retention Bolt
38L5G-02015D1R25	SM35-034-50	-	DS-T09W	-
38L5G-02018D1R25	SM35-042-50	-	DS-T09W	-
38L5H-02025D1R25	SM40-050-50	DS-T15T	-	-
38L5G-03015D1R01	SM35-034-50	-	DS-T09W	-
38L5G-03018D1R01	SM35-042-50	-	DS-T09W	-
38L5H-03025D1R01	SM40-050-50	DS-T15T	-	-
38L5G-04015D3R01	SM35-034-50	-	DS-T09W	-
38L5G-04018D3R01	SM35-042-50	-	DS-T09W	SD-08-47
38L5H-04025D3R01	SM40-050-50	DS-T15T	-	SD-08-47
38L5H-04031D3R01	SM40-060-50	DS-T15T	-	-
38L5G-05015D3R01	SM35-034-50	-	DS-T09W	SD-08-47
38L5G-05018D3R01	SM35-042-50	-	DS-T09W	SD-08-47
38L5H-05025D3R01	SM40-050-50	DS-T15T	-	-
38L5H-05031D3R01	SM40-060-50	DS-T15T	-	SD-08-47

VoMAX™ SERIES 3VL5V (AXIAL DRIVE)

MEDIUM DENSITY FACE MOUNT SLOTTERS WITH 8 INDEXES
(4 RH & 4 LH)



Slotting

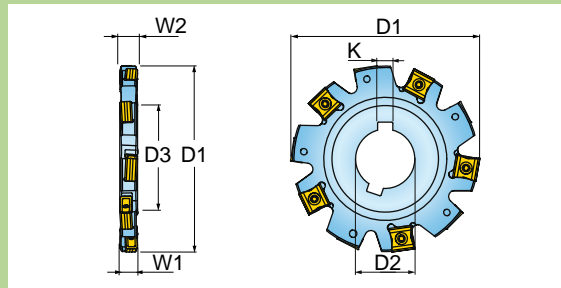

Cutter Number	W1 Cutter Width	D1 Nom. Dia.	D2 Bore Dia.	W2 Hub Width	D3 Hub Diameter	Keyway	Total Number of Inserts	Number of Effective Inserts
3VL5V-04037AG-01	0.375	4.000	1.250	0.375	2.25	0.312	10	5
3VL5V-04050AG-01	0.500	4.000	1.250	0.500	2.25	0.312	10	5
3VL5V-05037AH-01	0.375	5.000	1.500	0.375	2.75	0.375	12	6
3VL5V-05050AH-01	0.500	5.000	1.500	0.500	2.75	0.375	12	6
3VL5V-06037AH-02	0.375	6.000	1.500	0.375	2.75	0.375	14	7
3VL5V-06050AH-02	0.500	6.000	1.500	0.500	2.75	0.375	14	7
3VL5V-08037AK-01	0.375	8.000	2.000	0.375	3.50	0.500	16	8
3VL5V-08050AK-01	0.500	8.000	2.000	0.500	3.50	0.500	16	8

Operating guidelines on [page 382](#).

INSERTS

NNE324-108

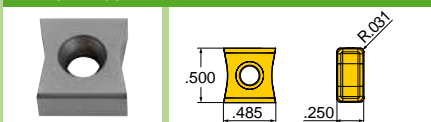

Part Number

Applications

Grade

IN2030

IN2040

IN6515

NNE324-108

Multi-Purpose - 0.031" R



● = P ● = M ● = K ● = N ● = S

HARDWARE



Screw



Driver

3VL5V-04037AG-01	SM40-080-30	DS-T15T
3VL5V-04050AG-01	SM40-100-00	DS-T15T
3VL5V-05037AH-01	SM40-080-30	DS-T15T
3VL5V-05050AH-01	SM40-100-00	DS-T15T
3VL5V-06037AH-02	SM40-080-30	DS-T15T
3VL5V-06050AH-02	SM40-100-00	DS-T15T
3VL5V-08037AK-01	SM40-080-30	DS-T15T
3VL5V-08050AK-01	SM40-100-00	DS-T15T

VOMAX™ SERIES 3VL5V (RADIAL DRIVE)

MEDIUM DENSITY FACE MOUNT SLOTTERS WITH 8 INDEXES
(4 RH & 4 LH)

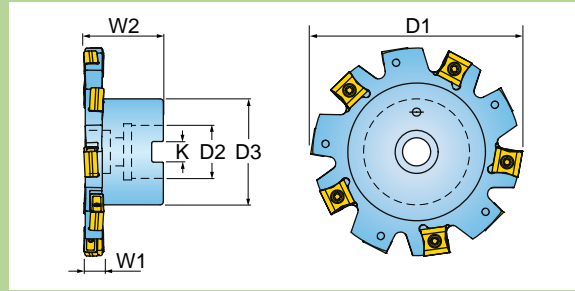

Cutter Number	W1 Cutter Width	D1 Nom. Dia.	D2 Bore Dia.	W2 Hub Width	D3 Hub Diameter	Keyway	Total Number of Inserts	Number of Effective Inserts
3VL5V-04037D3R01	0.375	4.000	1.000	1.500	2.00	0.375	10	5
3VL5V-04050D3R01	0.500	4.000	1.000	1.500	2.00	0.375	10	5
3VL5V-05037D3R01	0.375	5.000	1.000	1.500	2.75	0.375	12	6
3VL5V-05050D3R01	0.500	5.000	1.000	1.500	2.75	0.375	12	6
3VL5V-0603758R02	0.375	6.000	1.500	2.000	3.80	0.625	14	7
3VL5V-0605058R02	0.500	6.000	1.500	2.000	3.80	0.625	14	7
3VL5V-0803758R01	0.375	8.000	1.500	2.000	3.80	0.625	16	8
3VL5V-0805058R01	0.500	8.000	1.500	2.000	3.80	0.625	16	8

Operating guidelines on [page 382](#).

INSERTS

NNE324-108

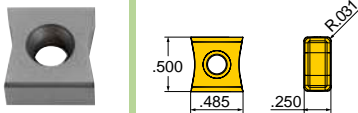

Part Number

Applications

Grade	IN2030	IN2040	IN6515						
-------	--------	--------	--------	--	--	--	--	--	--

NNE324-108

Multi-Purpose - 0.031" R



● = P ● = M ● = K ● = N ● = S

HARDWARE



Screw

Driver

Retention Bolt

3VL5V-04037D3R01	SM40-080-30	DS-T15T	SD-08-46
3VL5V-04050D3R01	SM40-100-00	DS-T15T	SD-08-46
3VL5V-05037D3R01	SM40-080-30	DS-T15T	SD-08-46
3VL5V-05050D3R01	SM40-100-00	DS-T15T	SD-08-46
3VL5V-0603758R02	SM40-080-30	DS-T15T	-
3VL5V-0605058R02	SM40-100-00	DS-T15T	-
3VL5V-0803758R01	SM40-080-30	DS-T15T	-
3VL5V-0805058R01	SM40-100-00	DS-T15T	-

HEAVY-DUTY AXIAL DRIVE SLOTTED WITH 4 INDEXES

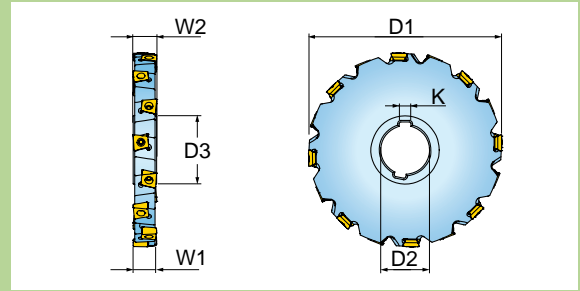

Cutter Number	W1 Cutter Width	D1 Nom. Dia.	D2 Bore Dia.	W2 Hub Width	D3 Hub Dia.	K Keyway	Total No. of Inserts	No. of Effective Inserts	Insert Series
3SJ6E-04062AG-01	0.625	4.000	1.250	0.625	2.25	0.312	10	5	DPM314
3SJ6H-04075AG-01	0.750	4.000	1.250	0.750	2.25	0.312	10	5	DPM324
3SJ6L-04100AG-01	1.000	4.000	1.250	1.000	2.25	0.312	8	4	DPM424
3SJ6E-05062AH-01	0.625	5.000	1.500	0.625	2.75	0.375	12	6	DPM314
3SJ6H-05075AH-01	0.750	5.000	1.500	0.750	2.75	0.375	12	6	DPM324
3SJ6L-05100AH-01	1.000	5.000	1.500	1.000	2.75	0.375	10	5	DPM424
3SJ6E-06062AH-01	0.625	6.000	1.500	0.625	3.50	0.375	14	7	DPM314
3SJ6H-06075AH-01	0.750	6.000	1.500	0.750	3.50	0.375	14	7	DPM324
3SJ6L-06100AH-01	1.000	6.000	1.500	1.000	3.50	0.375	12	6	DPM424
3SJ6E-08062AK-01	0.625	8.000	2.000	0.625	3.50	0.500	16	8	DPM314
3SJ6H-08075AK-01	0.750	8.000	2.000	0.750	3.50	0.500	16	8	DPM324
3SJ6L-08100AK-01	1.000	8.000	2.000	1.000	3.50	0.500	14	7	DPM424
3SJ6E-10062AK-01	0.625	10.000	2.000	0.625	3.50	0.500	18	9	DPM314
3SJ6H-10075AK-01	0.750	10.000	2.000	0.750	3.50	0.500	18	9	DPM324
3SJ6L-10100AK-01	1.000	10.000	2.000	1.000	3.50	0.500	16	8	DPM424

Operating guidelines on [page 381](#).

HARDWARE



3SJ6E-04062AG-01	SM40-120-20	DS-T15T
3SJ6H-04075AG-01	SM40-120-20	DS-T15T
3SJ6L-04100AG-01	SM50-160-10	DS-T20T
3SJ6E-05062AH-01	SM40-120-20	DS-T15T
3SJ6H-05075AH-01	SM40-120-20	DS-T15T
3SJ6L-05100AH-01	SM50-160-10	DS-T20T
3SJ6E-06062AH-01	SM40-120-20	DS-T15T
3SJ6H-06075AH-01	SM40-120-20	DS-T15T
3SJ6L-06100AH-01	SM50-160-10	DS-T20T
3SJ6E-08062AK-01	SM40-120-20	DS-T15T
3SJ6H-08075AK-01	SM40-120-20	DS-T15T
3SJ6L-08100AK-01	SM50-160-10	DS-T20T
3SJ6E-10062AK-01	SM40-120-20	DS-T15T
3SJ6H-10075AK-01	SM40-120-20	DS-T15T
3SJ6L-10100AK-01	SM50-160-10	DS-T20T

INSERTS

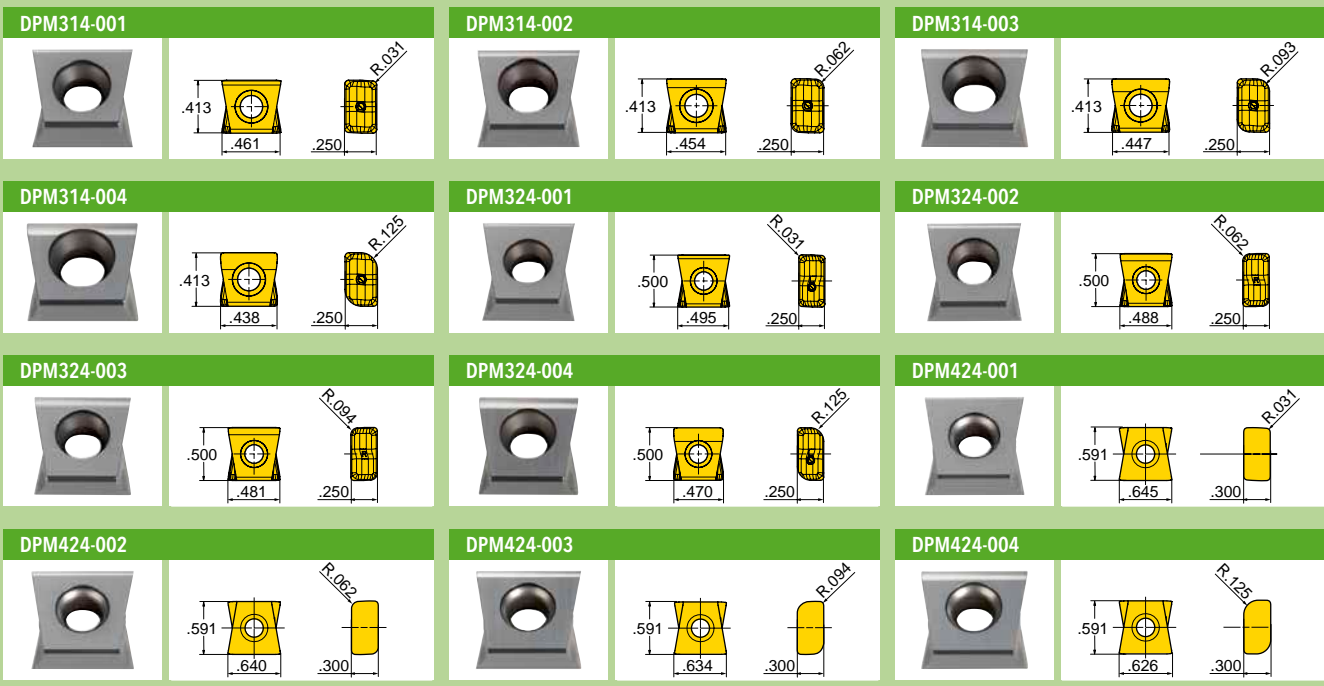

Part Number	Applications	Grade									
		IN2530	IN2005	IN2015	IN2040						
DPM314-001	Multi-Purpose - 0.031" R	●	●	●							
DPM314-002	Multi-Purpose - 0.062" R	●	●	●							
DPM314-003	Multi-Purpose - 0.094" R		●	●							
DPM314-004	Multi-Purpose - 0.125" R	●	●	●							
DPM324-001	Multi-Purpose - 0.031" R	●	●	●							
DPM324-002	Multi-Purpose - 0.062" R		●	●							
DPM324-003	Multi-Purpose - 0.094" R	●	●	●							
DPM324-004	Multi-Purpose - 0.125" R	●	●	●							
DPM424-001	Multi-Purpose - 0.031" R		●	●	●	●					
DPM424-002	Multi-Purpose - 0.062" R		●	●	●	●					
DPM424-003	Multi-Purpose - 0.094" R		●	●	●	●					
DPM424-004	Multi-Purpose - 0.125" R		●	●	●	●					

● = P ● = M ● = K ● = N ● = S

SOMAX™ SERIES 3SJ6 (RADIAL DRIVE)

HEAVY-DUTY RADIAL DRIVE SLOTTER WITH 4 INDEXES

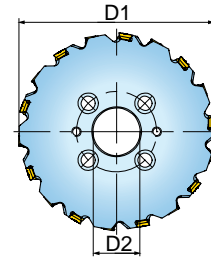
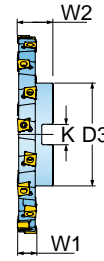

Cutter Number	W1 Cutter Width	D1 Nom. Dia.	D2 Bore Dia.	W2 Hub Width	D3 Hub Dia.	K Keyway	Total No. of Inserts	No. of Effective Inserts	Insert Series
3SJ6E-0406257R01	0.625	4.000	1.000	1.500	2.00	0.375	10	5	DPM314
3SJ6H-0407557R01	0.750	4.000	1.000	1.500	2.00	0.375	10	5	DPM324
3SJ6L-0410057R01	1.000	4.000	1.000	1.500	2.00	0.375	8	4	DPM424
3SJ6E-0506257R01	0.625	5.000	1.000	1.500	2.75	0.375	12	6	DPM314
3SJ6H-0507557R01	0.750	5.000	1.000	1.500	2.75	0.375	12	6	DPM324
3SJ6L-0510057R01	1.000	5.000	1.000	1.500	2.75	0.375	10	5	DPM424
3SJ6E-0606258R01	0.625	6.000	1.500	2.000	3.81	0.625	14	7	DPM314
3SJ6H-0607558R01	0.750	6.000	1.500	2.000	2.75	0.625	14	7	DPM324
3SJ6L-0610058R01	1.000	6.000	1.500	2.000	3.81	0.625	12	6	DPM424
3SJ6E-0806258R01	0.625	8.000	1.500	2.000	3.81	0.625	16	8	DPM314
3SJ6H-0807558R01	0.750	8.000	1.500	2.000	3.81	0.625	16	8	DPM324
3SJ6L-0810058R01	1.000	8.000	1.500	2.000	3.81	0.625	14	7	DPM424
3SJ6E-1006261R01	0.625	10.000	2.500	2.000	4.87	1.000	18	9	DPM314
3SJ6H-1007561R01	0.750	10.000	2.500	2.000	4.87	1.000	18	9	DPM324
3SJ6L-1010061R01	1.000	10.000	2.500	2.000	4.87	1.000	16	8	DPM424

Operating guidelines on [page 381](#).

HARDWARE



Screw



Driver

3SJ6E-0406257R01	SM40-120-20	DS-T15T
3SJ6H-0407557R01	SM40-120-20	DS-T15T
3SJ6L-0410057R01	SM50-160-10	DS-T20T
3SJ6E-0506257R01	SM40-120-20	DS-T15T
3SJ6H-0507557R01	SM40-120-20	DS-T15T
3SJ6L-0510057R01	SM50-160-10	DS-T20T
3SJ6E-0606258R01	SM40-120-20	DS-T15T
3SJ6H-0607558R01	SM40-120-20	DS-T15T
3SJ6L-0610058R01	SM50-160-10	DS-T20T
3SJ6E-0806258R01	SM40-120-20	DS-T15T
3SJ6H-0807558R01	SM40-120-20	DS-T15T
3SJ6L-0810058R01	SM50-160-10	DS-T20T
3SJ6E-1006261R01	SM40-120-20	DS-T15T
3SJ6H-1007561R01	SM40-120-20	DS-T15T
3SJ6L-1010061R01	SM50-160-10	DS-T20T

INSERTS

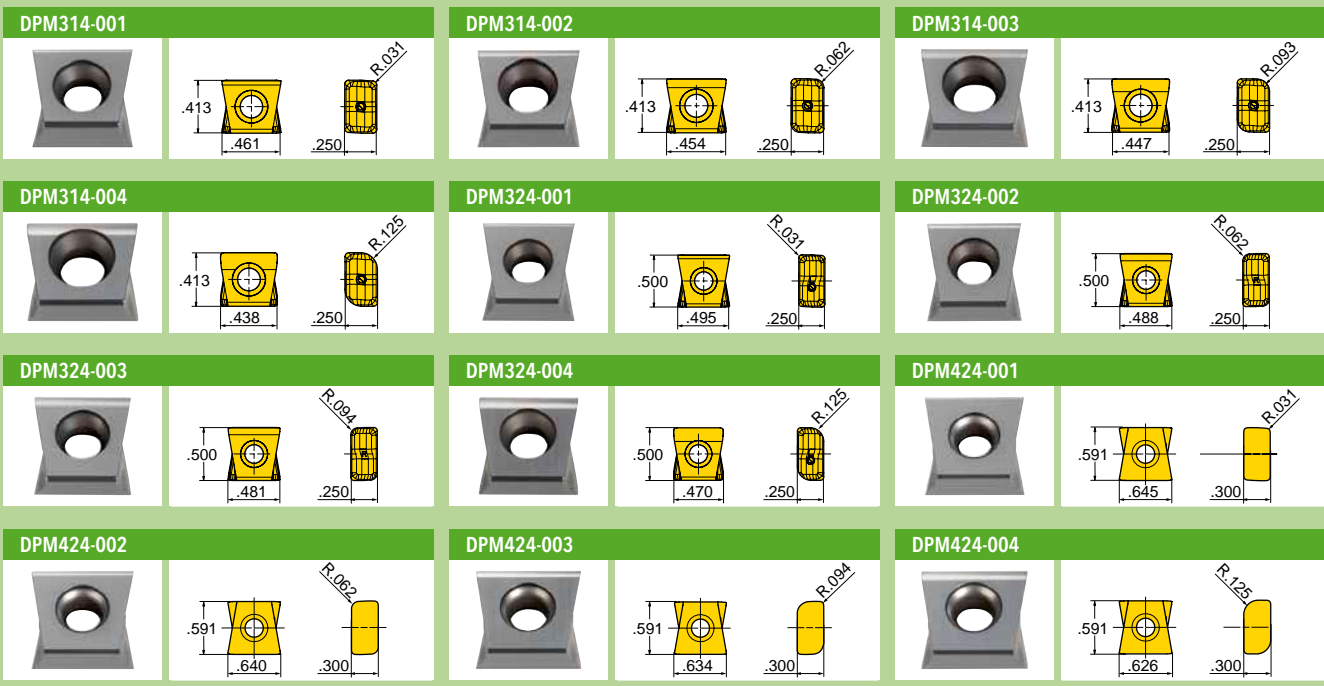

Part Number	Applications	Grade									
		IN2530	IN2005	IN2015	IN2040						
DPM314-001	Multi-Purpose - 0.031" R	●	●	●							
DPM314-002	Multi-Purpose - 0.062" R	●	●	●							
DPM314-003	Multi-Purpose - 0.094" R		●	●							
DPM314-004	Multi-Purpose - 0.125" R	●	●	●							
DPM324-001	Multi-Purpose - 0.031" R	●	●	●							
DPM324-002	Multi-Purpose - 0.062" R		●	●							
DPM324-003	Multi-Purpose - 0.094" R	●	●	●							
DPM324-004	Multi-Purpose - 0.125" R	●	●	●							
DPM424-001	Multi-Purpose - 0.031" R		●	●	●	●					
DPM424-002	Multi-Purpose - 0.062" R		●	●	●	●					
DPM424-003	Multi-Purpose - 0.094" R		●	●	●	●					
DPM424-004	Multi-Purpose - 0.125" R		●	●	●	●					

● = P ● = M ● = K ● = N ● = S

Ingersoll

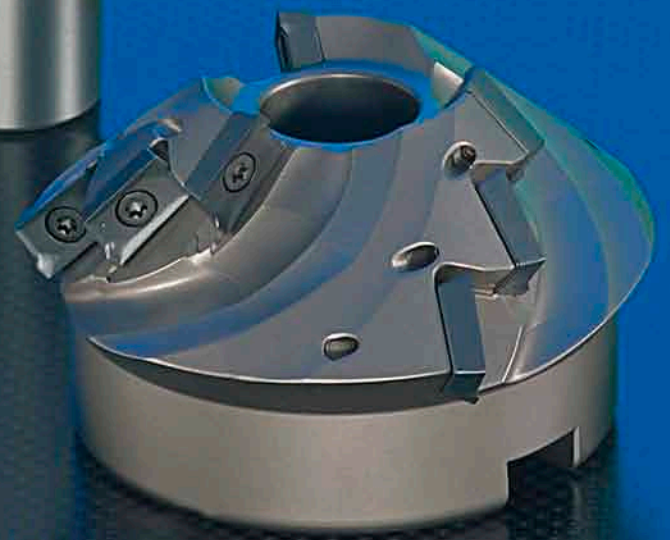





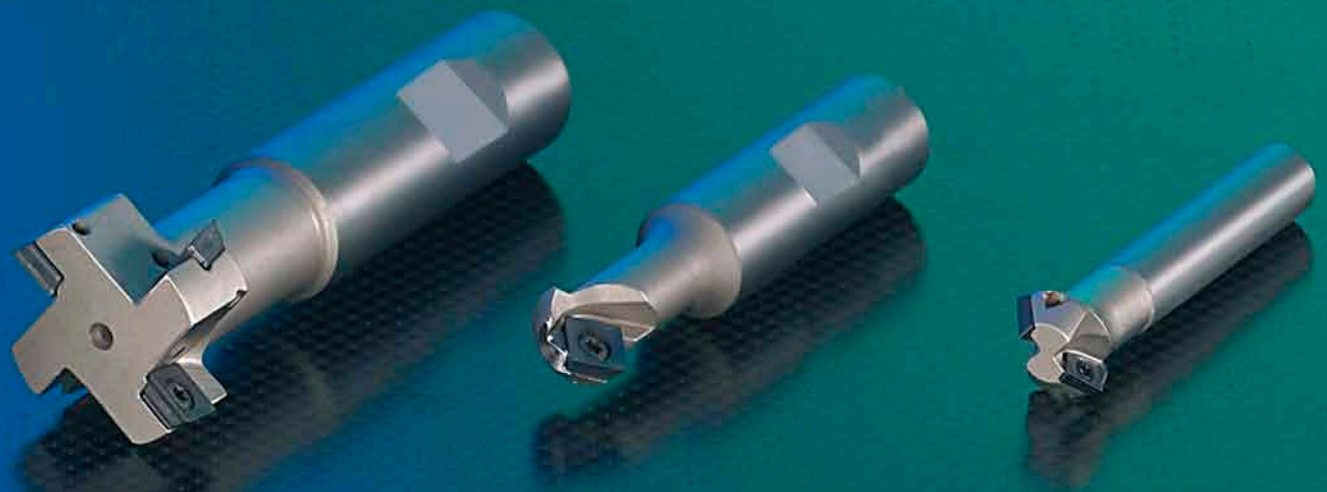





LEAD ANGLE & FORM MILLS.



Cutting Tools



Member IMC Group
Ingersoll
Cutting Tools

LEAD ANGLE & FORM MILLS.

	Diameter Range	Cutting Length	Description	Series	Page
	.312	.10 - .18	HI-POS® 30 Degree, 45 Degree, 60 Degree Lead End Mill	12P1D, 12N1D, 12M1D	222
	.250	.22	HI-POSQUAD 45 Degree, 60 Degree Lead Angle End Mill	15N1E, 15P1E	223
	.588 - .808	.22	HI-POSQUAD 45 Degree Lead Chamfer End Mill	15N1E (Top-On Style)	224
	1.375	.95	HI-POS+ 45 Degree Lead Extended Flute Shell Mill	22N3X	225
	.910 - 1.300	.27 - .38	HI-POSQUAD 15 Degree, 30 Degree, 45 Degree Lead Angle End Mill	15L1G, 15M1G, 15N1F, 15N1G	226
	.750 - 2.00	.18	HI-POSQUAD 45 Degree Lead Angle End Mill	15N1F_R00	227
	1.000	.26	HI-POSQUAD 45 Degree Lead Angle End Mill	15N1H	228
	.875 - 1.00	.69 - .85	ROUGH-AIR™ 30 Degree, 45 Degree Lead Angle End Mill	15M1H, 15N1H	229
	.750 - 1.000		FAST-BREAK™ Corner Rounding End Mill	15R1V	230
	1.000		FAST-BREAK™ Corner Rounding End Mill	15R1V (Top-on Style)	231

	Diameter Range	Cutting Length	Description	Series	Page
	1.00		FAST-BREAK Corner Rounding End Mill	15R4H	232
	1.000		FAST-BREAK Corner Rounding End Mill	15R4H (Top-on Style)	233
	.953 - 2.175	.385-1.094	SLOT-MAX T-Slot End Mill	15T, 12T	234

HIPOPOS™ SERIES 12P1D, 12N1D, 12M1D

30 DEGREE, 45 DEGREE, 60 DEGREE LEAD END MILL

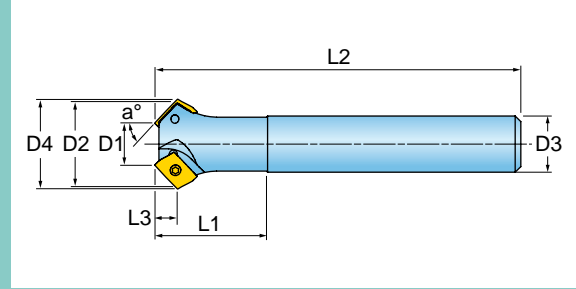

Cutter Number	Lead Angle	D1 Minor Dia.	D2 Major Dia.	L3 Max. DOC	L1 Extension Length	L2 Overall Length	D3 Shank Size/Style	D4 Overall Diameter	Number of Inserts
12M1D-0303287R01	30	0.312	0.524	0.10	3.22	5.00	.500" Weldon	0.48	2
12N1D-0303287R01	45	0.312	0.618	0.15	3.22	5.00	.500" Weldon	0.59	2
12P1D-0303287R01	60	0.312	0.690	0.18	3.22	5.00	.500" Weldon	0.66	2

Operating guidelines on [page 347](#).

INSERTS

AOCT060204FR-P	AOMT060202R	AOMT060204R

Part Number	Applications	Grade					
			IN05S	IN1030	IN2005	IN2030	IN2505
AOCT060204FR-P	Grd/Pol for Al - 0.015" R	●					
AOMT060202R	Multi-Purpose - 0.008" R		●	●	●		
AOMT060204R	Multi-Purpose - 0.015" R			●	●	●	
AOMT060208R	Multi-Purpose - 0.031" R			●	●	●	

● = P ● = M ● = K ● = N ● = S

HARDWARE		
	SM18-041-00	DS-TP06S

45 DEGREE, 60 DEGREE LEAD ANGLE END MILL



Lead Angle



Chamfer

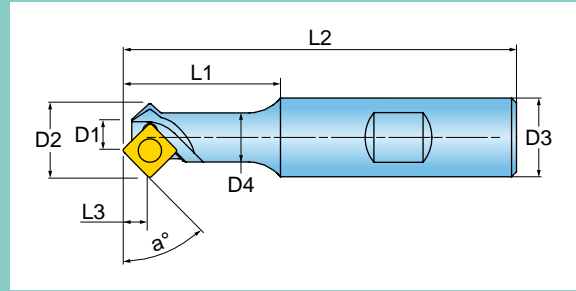
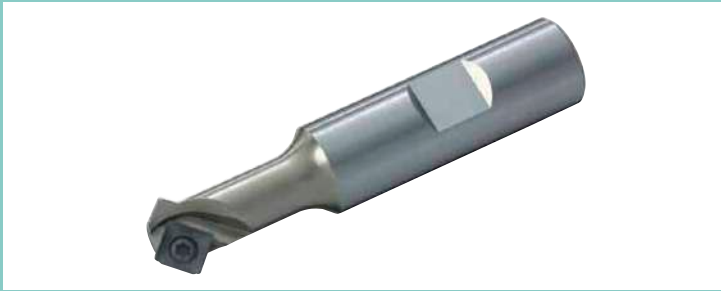

Cutter Number	Lead Angle	D1 Minor Dia.	D2 Major Dia.	L1 Extension Length	L2 Overall Length	L3 Max. DOC	D3 Shank Size/Style	D4 Neck Dia.	Number of Inserts
15N1E-0201584R01	45	0.250	0.692	1.50	3.50	0.22	.750" Weldon	0.44	1
15P1E-0201584R01	60	0.250	0.564	1.50	3.50	0.26	.750" Weldon	0.44	1

Operating guidelines on [page 353](#).

INSERTS

SDCT080305FN-P

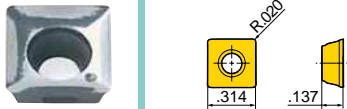

SDMT080305N



SDMT080308N



SDMT080316N

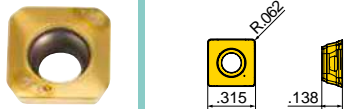

SDMW080305TN



SDMW080308TN



Part Number	Applications	Grade	IN1030	IN1530	IN2005	IN2015	IN2030	IN2040	IN30M
SDCT080305FN-P	Grd/Pol for Al - 0.020" R								
SDMT080305N	Multi-Purpose - 0.020" R								
SDMT080308N	Multi-Purpose - 0.031" R								
SDMT080316N	Multi-Purpose - 0.062" R								
SDMW080305TN	Heavy-Duty - 0.020" R								
SDMW080308TN	Heavy-Duty - 0.031" R								

= P = M = K = N = S

HARDWARE



Screw

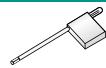

Driver

SM30-065-00

DS-T09W

HIPOPOSQUAD™ SERIES 15N1E (TOP-ON STYLE)

45 DEGREE LEAD CHAMFER END MILL

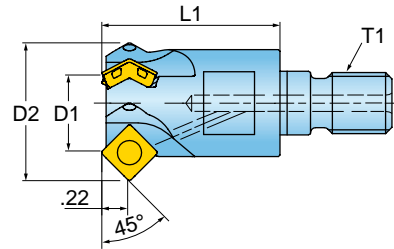

Cutter Number	D1 Minor Dia.	D2 Effective Dia.	T1 Adaption	L1 Extension Length	Overall Length	Number of Inserts	Wrench Size
15N1E-10012X7R01	0.588	1.000	M12	1.25	2.25	2	17mm
15N1E020035X7R00	0.787	1.086	M12	1.37	2.24	3	17mm
15N1E-12017X8R01	0.808	1.250	M16	1.75	2.75	3	22mm

For Top-On shanks and adaptors, see pages [page 730-737](#)
Operating guidelines on [page 353](#).

INSERTS

SDCT080305FN-P	SDMT080305N	SDMT080308N
SDMT080316N	SDMW080305TN	SDMW080308TN

Part Number	Applications	Grade	IN1030	IN1530	IN2005	IN2015	IN2030	IN2040	IN30M		
SDCT080305FN-P	Grd/Pol for Al - 0.020" R										●
SDMT080305N	Multi-Purpose - 0.020" R		●		●	●	●	●			
SDMT080308N	Multi-Purpose - 0.031" R			●							
SDMT080316N	Multi-Purpose - 0.062" R			●							
SDMW080305TN	Heavy-Duty - 0.020" R		●		●	●	●				
SDMW080308TN	Heavy-Duty - 0.031" R			●							

● = P ● = M ● = K ● = N ● = S

HARDWARE



Screw

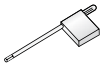

Driver

SM30-065-00

DS-T09W

45 DEGREE LEAD EXTENDED FLUTE SHELL MILL



Lead Angle



Chamfer

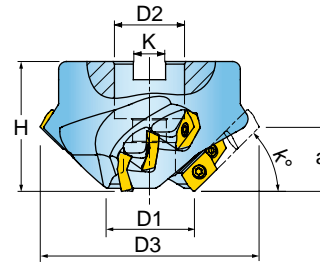

Cutter Number	D1 Nom. Diam.	D3 Overall Diam.	K Lead Angle	a Depth of Cut	Number of Inserts	H Height	D2 Bore Diameter	K Keyway
22N3X-13020D3R01	1.375	3.300	45	0.95	9	2.000	1.000	0.375

Operating guidelines on [page 346](#).

In side stations, use .031" R or smaller to ensure overlap

INSERTS

AOCT120408FR-P

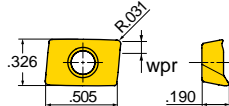

AOMT120404R

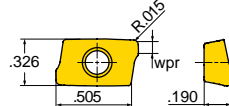

AOMT120408FR

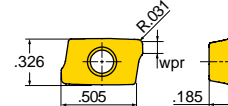

AOMT120408R

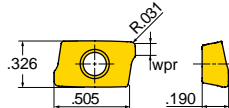

AOMT120416R

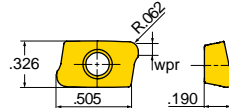

AOMT120424R

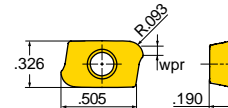

AOMT120430FR

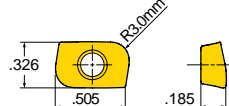

AOMT120432R

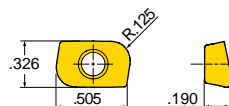

Part Number	Applications	Grade									
			IN1030	IN10K	IN2005	IN2010	IN2030	IN2040	IN2505	IN2510	
AOCT120408FR-P	Grd/Pol for Al - 0.031" R			●							
AOMT120404R	Multi-Purpose - 0.015" R		●		●						
AOMT120408FR	Hi-Temp/Ti - 0.031" R				●		●				
AOMT120408R	Multi-Purpose - 0.031" R		●		●	●	●	●	●		
AOMT120416R	Multi-Purpose - 0.062" R		●		●		●			●	
AOMT120424R	Multi-Purpose - 0.093" R				●		●				
AOMT120430FR	Multi-Purpose - 3.000 mm R				●						
AOMT120432R	Multi-Purpose - 0.125" R		●		●	●	●	●			

● = P ● = M ● = K ● = N ● = S

HARDWARE



Screw



Driver



Retention Bolt

SM35-088-10

DS-T10T

SD-08-47

HIPOPOSQUAD™ SERIES 15L1G, 15M1G, 15N1F, 15N1G

15 DEGREE, 30 DEGREE, 45 DEGREE LEAD END MILL

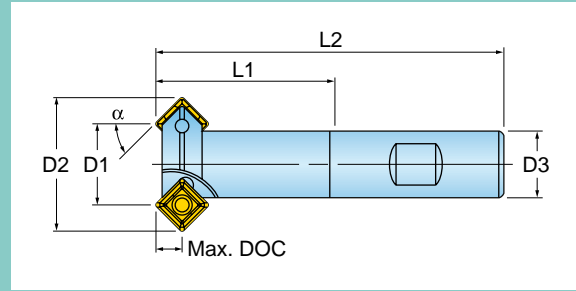

Cutter Number	Lead Angle	D1 Minor Dia.	D2 Major Dia.	Max. Depth of Cut	L1 Extension Length	L2 Overall Length	D3 Shank Size/Style	Number of Inserts	Insert Series
15L1G-1502084R01	15	1.300	1.500	0.38	2.00	4.00	.750" Weldon	2	SHLT11
15M1G-1502084R01	30	1.066	1.500	0.34	2.00	4.00	.750" Weldon	2	SHLT11
15N1F-1001584R01	45	0.495	1.000	0.23	1.50	3.50	.750" Weldon	1	SHLT09
15N1F-1201584R01	45	0.745	1.250	0.23	1.50	3.50	.750" Weldon	2	SHLT09
15N1G-1502084R01	45	0.910	1.500	0.27	2.00	4.00	.750" Weldon	2	SHLT11

Operating guidelines on [page 346](#).

INSERTS



Part Number	Applications	Grade	IN1030	IN2005	IN30M	IN40P	IN6530				
-------------	--------------	-------	--------	--------	-------	-------	--------	--	--	--	--

SHLT090308N-HR	Multi-Purpose - 0.031" R		●	●	●						
SHLT110408TN-HR	Multi-Purpose - 0.031" R		●	●	●	●	●				

● = P ● = M ● = K ● = N ● = S

HARDWARE

	Screw	Driver	Driver
15L1G-1502084R01	SM40-093-20	-	DS-T15T
15M1G-1502084R01	SM40-093-20	-	DS-T15T
15N1F-1001584R01	SM30-065-00	DS-T09W	-
15N1F-1201584R01	SM30-065-00	DS-T09W	-
15N1G-1502084R01	SM40-093-20	-	DS-T15T

45 DEGREE LEAD END MILL



Chamfer



Facing

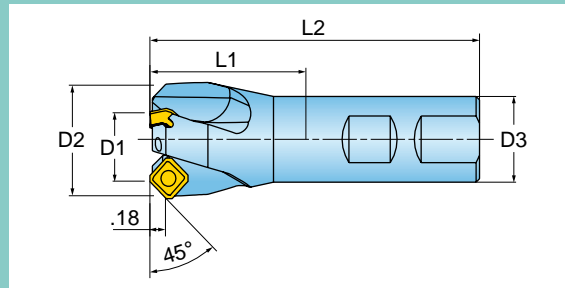

Cutter Number	D1 Minor Dia.	D2 Major Dia.	L1 Extension Length	L2 Overall Length	D3 Shank Size/Style	Number of Inserts
15N1F-0701584R00	0.750	1.130	1.50	3.50	.750" Weldon	2
15N1F-1001780R00	1.000	1.380	1.75	3.75	1.000" Weldon	3
15N1F-2001940R00	2.000	2.400	1.90	5.90	R8 Bridgeport	5

Operating guidelines on [page 346](#).

INSERTS

SEKT09T3AFFN-P

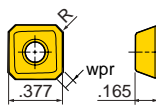

SEKT09T3AFN

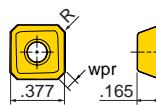
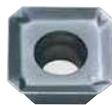

Part Number	Applications	Grade										
			IN1030	IN2005	IN2030	IN2040	IN30M					
SEKT09T3AFFN-P	Grd/Pol for Al - 0.015" R											
SEKT09T3AFN	Multi-Purpose - 0.015" R											

● = P ● = M ● = K ● = N ● = S

HARDWARE



Screw



Driver

15N1F-0701584R00	SM30-065-00	DS-T09W
15N1F-1001780R00	SM30-065-00	DS-T09W
15N1F-2001940R00	SM30-082-00	DS-T09W

45 DEGREE LEAD END MILL

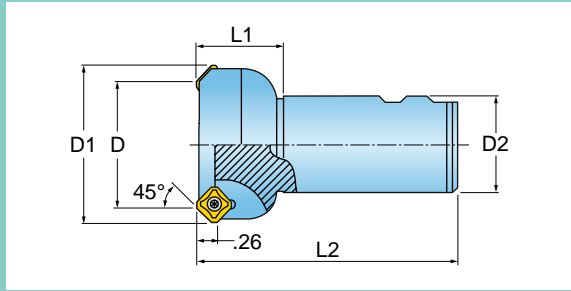

Cutter Number	D Nominal Dia.	D1 Major Dia.	L1 Extension Length	L2 Overall Length	D2 Shank Diameter	Number of Inserts
15N1H-1001180R00	1.000	1.47	1.09	3.50	1.000" Weldon	2

Operating guidelines on [page 349](#).

INSERTS

GEKT12T3AFTR-WC

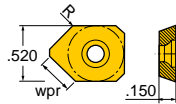
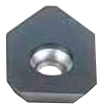

SEKT12T3AFTN-M

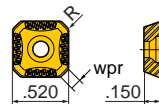

Part Number	Applications	Grade	IN1030	IN2005	IN2040	IN2510	IN2540	IN40P		
-------------	--------------	-------	--------	--------	--------	--------	--------	-------	--	--

GEKT12T3AFTR-WC

Wiper - 0.047" R



SEKT12T3AFTN-M

Multi-Purpose - 0.043" R



● = P ● = M ● = K ● = N ● = S

HARDWARE



Screw



Driver

SM35-089-00

DS-T15T

30 DEGREE, 45 DEGREE LEAD END MILL



Lead Angle



Chamfer



Facing

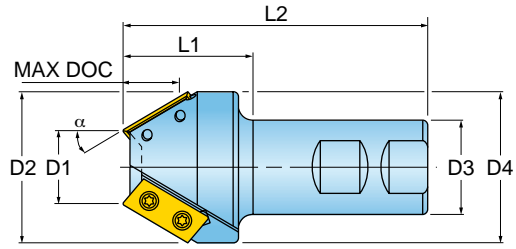

Cutter Number	Lead Angle	D1 Minor Dia.	D2 Major Dia.	Max. Depth of Cut	L1 Extension Length	L2 Overall Length	D3 Shank Size/Style	D4 Overall Diameter	Number of Inserts	Number of Effective Inserts
15M1H-1001781R01	30	1.000	2.015	0.85	1.75	4.00	1.250" Weldon	2.08	2	2
15N1H-0802286R01	45	0.875	2.279	0.69	2.25	4.91	1.500" Weldon	2.63	2	2

Operating guidelines on [page 349](#).

INSERTS

BEHW250304R

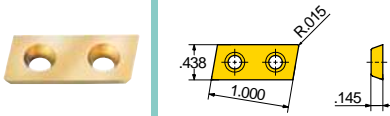

BEHW250304R-P

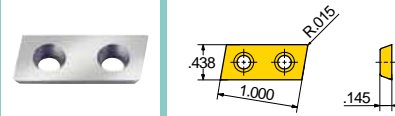

BEHW250308R

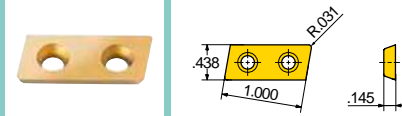

BEHW250308R-P

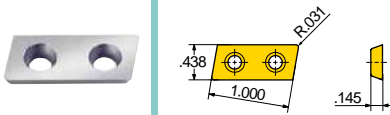

BEHW250316R

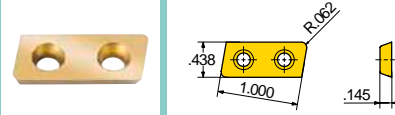

BEHW250316R-P

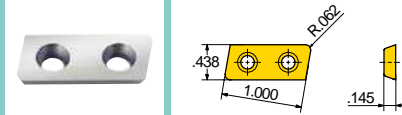

Part Number	Applications	Grade									
		IN1540	IN15K								
BEHW250304R	Multi-Purpose - 0.015" R	●									
BEHW250304R-P	Grd/Pol for Al - 0.015" R		●								
BEHW250308R	Multi-Purpose - 0.031" R	●									
BEHW250308R-P	Grd/Pol for Al - 0.031" R		●								
BEHW250316R	Multi-Purpose - 0.062" R	●									
BEHW250316R-P	Grd/Pol for Al - 0.062" R		●								

● = P ● = M ● = K ● = N ● = S

HARDWARE



Screw



Driver

SE06-037-00

DS-T15T

CORNER ROUNDING END MILL

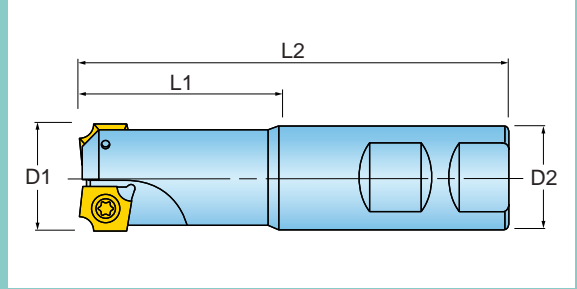

Cutter Number	D1 Nom. Dia.	L1 Extension Length	L2 Overall Length	D2 Shank Size/Style	Number of Inserts	Coolant Thru
15R1V-0702084R01	0.750	2.000	4.25	.750" Weldon	1	Yes
15R1V-1002080R01	1.000	2.000	4.25	1.000" Weldon	2	Yes

Operating guidelines on [page 350](#).

INSERTS

BEEW120308R-CR 	BEEW120310R-CR 	BEEW120316R-CR
BEEW120320R-CR 	BEEW120325R-CR 	BEEW120330R-CR
BEEW120332R-CR 		

Part Number	Applications	Grade				
		IN2030	IN2040			
BEEW120308R-CR	Multi-Purpose - 0.031" Corner rounding	●				
BEEW120310R-CR	Multi-Purpose - 1.000 mm Corner rounding	●				
BEEW120316R-CR	Multi-Purpose - 0.062" Corner rounding	●	●			
BEEW120320R-CR	Multi-Purpose - 2.000 mm Corner rounding	●				
BEEW120325R-CR	Multi-Purpose - 0.094" Corner rounding	●				
BEEW120330R-CR	Multi-Purpose - 3.000 mm Corner rounding	●				
BEEW120332R-CR	Multi-Purpose - 0.125" Corner rounding	●	●			

For programming dimensions, see [page 319](#).

● = P ● = M ● = K ● = N ● = S

HARDWARE



Screw

Driver

SE06-028-00

DS-T15T

FAST-BREAK™ SERIES 15R1V (TOP-ON STYLE)

CORNER ROUNDING END MILL

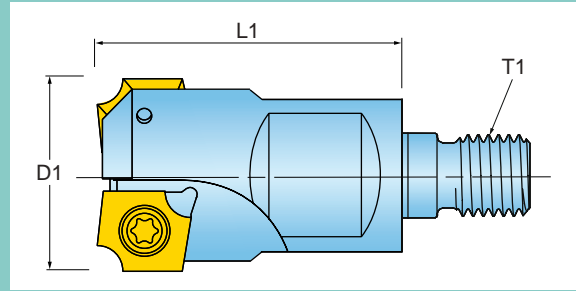

Cutter Number	D1 Nominal Diameter	T1 Adaption	L1 Extension Length	Number of Inserts	Wrench Size
15R1V-10015X7R01	1.000	M12	1.50	2	17mm

For Top-On shanks and adaptors, see [pages 730-737](#).
Operating guidelines on [page 350](#).

INSERTS

BEEW120308R-CR 	BEEW120310R-CR 	BEEW120316R-CR
BEEW120320R-CR 	BEEW120325R-CR 	BEEW120330R-CR
BEEW120332R-CR 		

Part Number	Applications	Grade									
		IN2030	IN2040								
BEEW120308R-CR	Multi-Purpose - 0.031" Corner rounding	●									
BEEW120310R-CR	Multi-Purpose - 1.000 mm Corner rounding	●									
BEEW120316R-CR	Multi-Purpose - 0.062" Corner rounding	●	●								
BEEW120320R-CR	Multi-Purpose - 2.000 mm Corner rounding	●									
BEEW120325R-CR	Multi-Purpose - 0.094" Corner rounding	●									
BEEW120330R-CR	Multi-Purpose - 3.000 mm Corner rounding	●									
BEEW120332R-CR	Multi-Purpose - 0.125" Corner rounding	●	●								

For programming dimensions, see [page 319](#).

● = P ● = M ● = K ● = N ● = S

HARDWARE



Screw



Driver

SE06-028-00

DS-T15T

CORNER ROUNDING END MILL

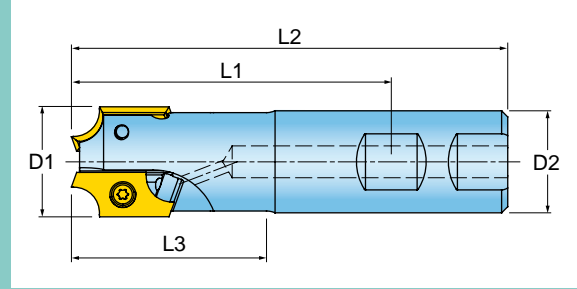

Cutter Number	D1 Nom. Dia.	L1 Extension Length	L2 Overall Length	D2 Shank Size/Style	Number of Inserts	Coolant Thru
15R4H-1002080R01	1.000	2.000	4.25	1.000" Weldon	2	Yes

Operating guidelines on [page 350](#).

INSERTS

FEEW250340R-CR		FEEW250348R-CR		FEEW250350R-CR	
FEEW250360R-CR		FEEW250364R-CR			

Part Number	Applications	Grade	IN2030							
FEEW250340R-CR	Multi-Purpose - 4.000 mm Corner rounding									
FEEW250348R-CR	Multi-Purpose - 0.187" Corner rounding									
FEEW250350R-CR	Multi-Purpose - 5.000 mm Corner rounding									
FEEW250360R-CR	Multi-Purpose - 6.000 mm Corner rounding									
FEEW250364R-CR	Multi-Purpose - 0.250" Corner rounding									

For programming dimensions, see [page 319](#).

● = P ● = M ● = K ● = N ● = S

HARDWARE



Screw

Driver

SE06-028-00

DS-T15T

FAST-BREAK™ SERIES 15R4H (TOP-ON STYLE)

CORNER ROUNDING END MILL

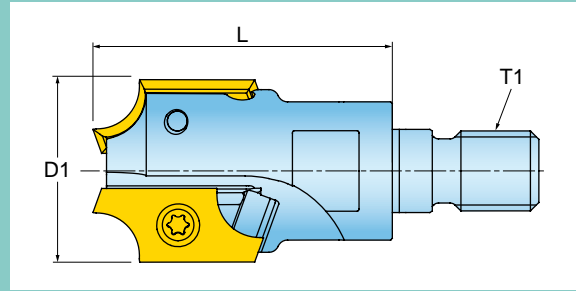

Cutter Number	D1 Nominal Diameter	T1 Adaption	L1 Extension Length	Number of Inserts	Wrench Size
15R4H-10015X7R01	1.000	M12	1.75	2	17mm

For Top-On shanks and adaptors, see [pages 730-737](#).
Operating guidelines on [page 350](#).

INSERTS

FEEW250340R-CR

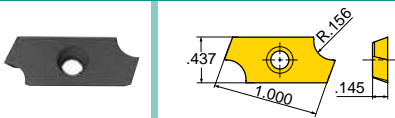

FEEW250348R-CR

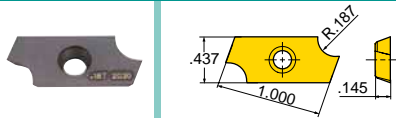

FEEW250350R-CR

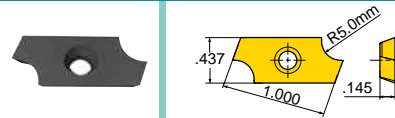

FEEW250360R-CR

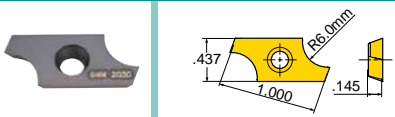

FEEW250364R-CR

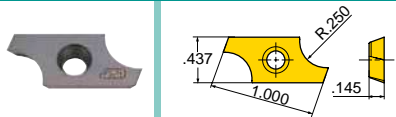

Part Number	Applications	Grade	IN2030								
FEEW250340R-CR	Multi-Purpose - 4.000 mm Corner rounding										
FEEW250348R-CR	Multi-Purpose - 0.187" Corner rounding										
FEEW250350R-CR	Multi-Purpose - 5.000 mm Corner rounding										
FEEW250360R-CR	Multi-Purpose - 6.000 mm Corner rounding										
FEEW250364R-CR	Multi-Purpose - 0.250" Corner rounding										

For programming dimensions, see [page 319](#).

= P = M = K = N = S

HARDWARE



SE06-028-00

DS-T15T

T-SLOT END MILL

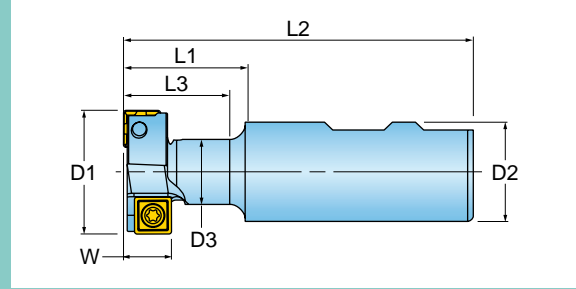

Cutter Number	T-Bolt Size	D1 Nom. Diam.	W Width of Cut	L1 Exten.	L2 Overall Length	D2 Shank Size/Style	D3 Neck Dia.	L3 Neck Length	Total No. of Inserts	Insert Series	Coolant Thru
15T1D-0902580R01	0.500	0.953	0.385	2.50	4.75	1.000" Weldon	0.51	1.10	4	SPLT06	No
15T1F-1201280R01	0.625	1.250	0.480	1.25	3.50	1.000" Weldon	0.66	1.06	2	SHLT09	Yes
15T1F-1401580R01	0.750	1.464	0.620	1.50	3.75	1.000" Weldon	0.79	1.38	4	SHLT09	Yes
12T1B-1701981R01	1.000	1.795	0.828	1.94	4.19	1.250" Weldon	0.87	1.71	4	APKT16	No
12T1B-2102281R01	1.250	2.175	1.094	2.25	4.50	1.250" Weldon	1.21	2.13	6	APKT16	No

Operating guidelines on [page 382](#).

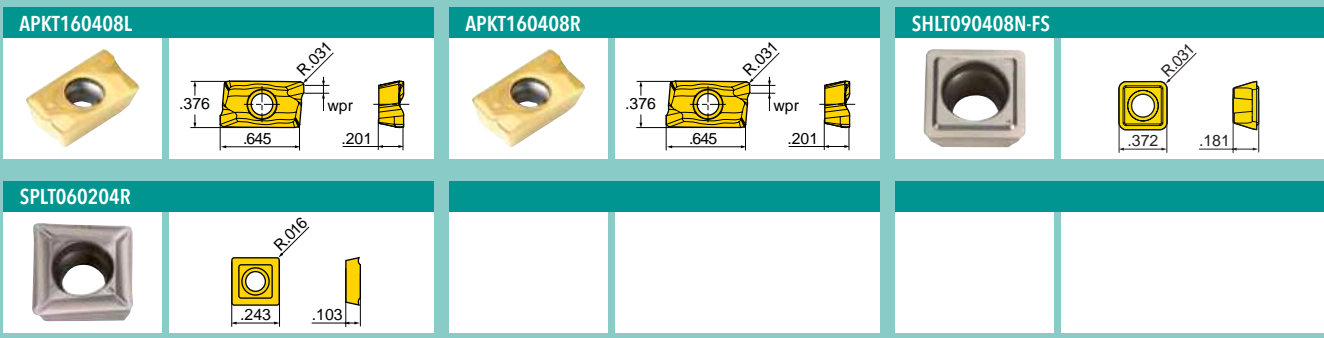

INSERTS



Part Number	Applications	Grade	IN1030	IN1040	IN2005	IN2015	IN2030	IN2040	IN30M
APKT160408L	Multi-Purpose - 0.031" R		●						
APKT160408R	Multi-Purpose - 0.031" R		●		●	●	●	●	
SHLT090408N-FS	Heavy-Duty - 0.031" R		●		●				
SPLT060204R	Multi-Purpose - 0.015" R		●	●					●

● = P
 ● = M
 ● = K
 ● = N
 ● = S

HARDWARE

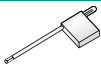
			
	Screw	Driver	Driver
15T1D-0902580R01	SM22-052-00	-	DS-T07F
15T1F-1201280R01	SM40-080-30	DS-T15T	-
15T1F-1401580R01	SM40-093-20	DS-T15T	-
12T1B-1701981R01	SM40-120-20	DS-T15T	-
12T1B-2102281R01	SM40-120-20	DS-T15T	-

Ingersoll



CUTTING TOOLS
CUTTING TOOLS

PROFILE, HI FEED & PLUNGING MILLS.

Cutting Tools













Member IMC Group
Ingersoll
Cutting Tools

PROFILE, HI FEED & PLUNGING MILLS.

	Diameter	Cutting Depth	Description	Series	Page
	.750 - 1.500	.18	FORM MASTER Button End Mill, .375 IC	15B1F	244
	1.000 - 1.500	.25	FORM MASTER Button End Mill, .500 IC	15B4H	245
	1.000 - 1.500	.25	FORM MASTER Button End Mill, .500 IC	15B4J (Top-on Style)	246
	2.000 - 6.000	.250	FORM MASTER Button Face Mill, .500 IC	5W6J	248
	1.250 - 1.500	.25	FORM MASTER Ceramic Button End Mill, .500 IC	1DB1H	250
	2.000 - 3.000	.25	FORM MASTER Ceramic Button Face Mill, .500 IC	DW*H	251
	1.500	.37	FORM MASTER Toroid Button End Mill, .750 IC	15B4M	252
	3.000 - 6.000	.37	FORM MASTER Button Face Mill, .750 IC	5W6N	253
	2.000 - 6.000	.50 - 1.00	FORM MASTER Button Face Mill	5W6	254
	2.000	.50	FORM MASTER Toroid Button End Mill, 1.00 IC	15W4S	256

	Diameter	Cutting Depth	Description	Series	Page
	2.000	.50	FORM MASTER Toroid Button Face Mill, 1.00 IC	5W6	254
	4.000 - 6.000	.50	FORM MASTER Button Face Mill, 1.00 IC	5W6S	257
	.750 - 1.500 16mm - 42mm	1.5mm - 8mm	FORM MASTER+ Button Cutter	15B1 (Top-on)	258
	2.000 - 6.000	5mm - 10mm	FORM MASTER+ Button Cutter	5W7	260
	.750 - 1.500 20mm - 42mm	.06 - .08	FORM MASTER^{EFSD} High Feed Modular End Mill	15V1E, 15V1H (Top-On Style)	262
	2.000 - 4.000	.06 - .08	FORM MASTER^{EFSD} High Feed Face Mill	5V6E, 5V6H	264
	.625 - 1.500	.04	POWER FEED^{+MINI} High Feed End Mill	1TG1F	266
	.625 - 1.250	.04	POWER FEED^{+MINI} High Feed Modular End Mill	1TG1F (Top-On Style)	267
	2.000 - 3.000	.04	POWER FEED^{+MINI} High Feed Face Mill	TG1F	268
	1.250 - 1.500	.07	POWER FEED⁺ High Feed End Mill	1DG1H	269



PROFILE, HI FEED & PLUNGING MILLS.

	Diameter	Cutting Depth	Description	Series	Page
	1.25 - 1.500	.07	POWER FEED+ High Feed Modular End Mill	1DG1H (Top-On Style)	269
	2.000 - 6.000	.07	POWER FEED+ High Feed Face Mill	DG6H	271
	2.000 - 8.000	.040 - .120	SOMAX HI FEED 80° Lead High Feed Face Mill	SP6H, SP6N	272
	1.250 - 1.500	.08	HI FEED DEKA High Feed End Mill	1DP1G	274
	1.250 - 1.500	.06	HI FEED DEKA High Feed Modular End Mill	1DP1G (Top-On Style)	275
	2.000 - 6.000	.06	HI FEED DEKA High Feed Face Mill	DP5G	276
	1.000 - 1.500	6mm	FORM MASTER PRO End Mill, 12mm IC	15E1H	277
	1.000 - 1.500	6mm - 8mm	FORM MASTER PRO Button Cutter	15E1K (Top-on)	278
	2.000 - 6.000	6mm - 8mm	FORM MASTER PRO Button Cutter	5E6K, 5E6H	280
	.750 - 1.000		FORM MASTER V Back Draft Finish End Mill	15V	282

	Diameter	Cutting Depth	Description	Series	Page
	.750 - 1.250		FORM MASTER[™] Back Draft Modular Finish Cutter	15V (Top-On Style)	283
	2.000		FORM MASTER[™] Back Draft Finish Shell Mill	5V6G	284
	.375 - 1.250		FINISH BALL Finish Ball Nose End Mill	12W9	286
	.375 - 1.000		FINISH BALL Finish Ball Nose Modular End Mill	12W9 (Top-On Style)	288
	.375 - .750		FINISH BALL Finish Ball Nose End Mill - Carbide	12W5 (Solid Carbide)	290
	.500 - 2.000	.25 - 2.70	PRO BALL Ball Nose End Mill, 2 Effective	1BW, 2BW	296
	.500 - 1.000	.25 - .50	PRO BALL Ball Nose End Mill	1BW (Top-On Style)	294
	.500 - .750	.25 - .38	PRO BALL Modular Ball Nose End Mill	1BW (Chip Surfer Style)	295
	2.000	1.70	PRO BALL Toroid Style Ball Nose End Mill	1BW (Hi Tork Style)	296
	.750 - 1.000	.28 - .40	PUNCH IN QUAD Modular Plunging Cutter	DHU (Top-On Style)	297



PROFILE, HI FEED & PLUNGING MILLS.

	Diameter	Cutting Depth	Description	Series	Page
	2.000 - 4.000	.75 - 1.25	PUNCH-INQUAD Modular Plunging Cutter	DHU	298
	2.000 - 4.000	.375 - 5.90	SoMAX Plunging Cutter	SHU	299
	2.000 - 6.000	.470	VoMAX Plunging Cutter	VHU	300

BUTTON END MILL, 375 IC BUTTON

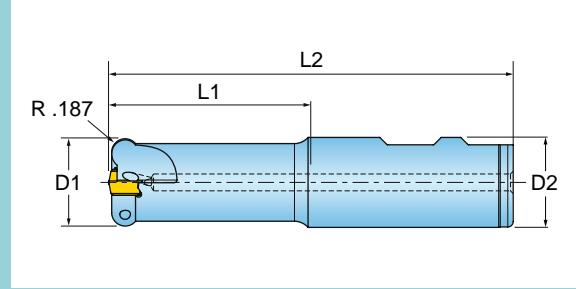

Cutter Number	D1 Nom. Dia.	L1 Extension Length	L2 Overall Length	D2 Shank Size/Style	Number of Inserts	Ramp Angle
15B1F-0701784R01	0.750	1.75	3.75	.750" Weldon	1	26
15B1F-1001780R01	1.000	1.75	4.00	1.000" Weldon	2	9
15B1F-1003780R01	1.000	3.75	6.00	1.000" Weldon	2	9
15B1F-1201281R01	1.250	4.25	6.50	1.250" Weldon	3	5.9
15B1F-1504281R01	1.500	4.25	6.50	1.250" Weldon	4	4

Operating guidelines on [page 374](#).

INSERTS

RPLT090400N

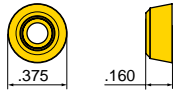

Part Number	Applications	Grade							
		IN1530	IN1540	IN2030	IN6530				
RPLT090400N	Multi-Purpose - 0.187" R								

HARDWARE



Screw

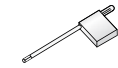

Driver

SM30-065-00

DS-T09W

BUTTON END MILL, .500 IC BUTTON



Ramping



Corkscrew



Facing



Contour



Coolant

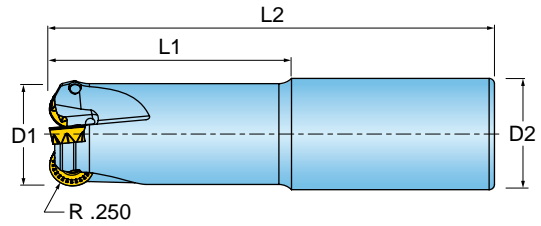

Cutter Number	D1 Nom. Dia.	L1 Extension	Number of Inserts	L2 Overall Length	D2 Shank Size/Style	Coolant Thru	Ramp Angle
15B4H-1002280R01	1.000	1.75	2	4.50	1.000" Weldon	No	1
15B4H-1003751R01	1.000	2.00	2	6.00	1.000" Cylindrical	No	1
15B4H-1252781R01	1.250	2.75	3	5.00	1.250" Weldon	Yes	4.9
15B4H-1253759R01	1.250	2.00	3	6.00	1.250" Cylindrical	Yes	4.9
15B4H-1502386R01	1.500	2.34	4	5.00	1.500" Weldon	Yes	6.8
15B4H-1503355R01	1.500	2.00	4	6.00	1.500" Cylindrical	Yes	6.8

Operating guidelines on [page 374](#).

INSERTS

RCHX120400FN-P



RCKX120400TN-M



RCLB120500TN-VL



Part Number	Applications	Grade	Applications							
			IN10K	IN2005	IN2030	IN2040	IN2505	IN5515		
RCHX120400FN-P	Grd/Pol for Al - 0.250" R		●							
RCKX120400TN-M	Standard - 0.250" R			●	●		●	●		
RCLB120500TN-VL	Heavy-Duty - 0.250" R			●		●			●	

● = P ● = M ● = K ● = N ● = S ○ = H

HARDWARE



Screw



Driver

15B4H-1002280R01	SM35-089-00	DS-T15T
15B4H-1003751R01	SM35-089-00	DS-T15T
15B4H-1252781R01	SM35-110-00	DS-T15T
15B4H-1253759R01	SM35-110-00	DS-T15T
15B4H-1502386R01	SM35-097-00	DS-T15T
15B4H-1503355R01	SM35-097-00	DS-T15T



BUTTON END MILL, .500 IC BUTTON



Channel



Ramping



Pocket



Facing



Contour



Coolant

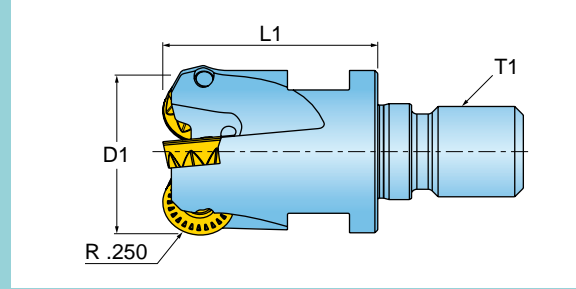

Cutter Number	D1 Nom. Dia.	L1 Extension Length	T1 Thread Size	No. of Inserts	Coolant Thru	Ramp Angle	Wrench Size
15B4J-10015X7R01	1.000	1.50	M12	2	No	1.0	17mm
15B4J-12017X8R01	1.250	1.50	M16	3	Yes	4.5	22mm
15B4J-15017X8R01	1.500	1.50	M16	3	Yes	6.5	22mm

For Top-On shanks and adaptors, see [pages 730-737](#).
Operating guidelines on [page 374](#).

INSERTS

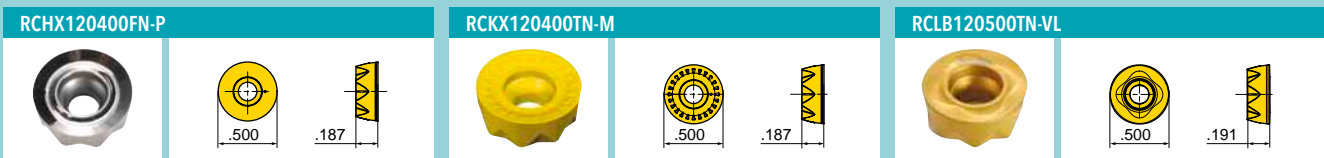

Part Number	Applications	Grade	IN10K	IN2005	IN2030	IN2040	IN2505	IN5515	IN6530		
-------------	--------------	-------	-------	--------	--------	--------	--------	--------	--------	--	--

RCHX120400FN-P	Grd/Pol for Al - 0.250" R		●								
RCKX120400TN-M	Standard - 0.250" R			●	●		●	●			
RCLB120500TN-VL	Heavy-Duty - 0.250" R			●		●			●		

● = P ● = M ● = K ● = N ● = S ● = H

HARDWARE



15B4J-10015X7R01	SM35-089-00	DS-T15T
15B4J-12017X8R01	SM35-110-00	DS-T15T
15B4J-15017X8R01	SM35-110-00	DS-T15T

BUTTON FACE MILL, .500 IC BUTTON

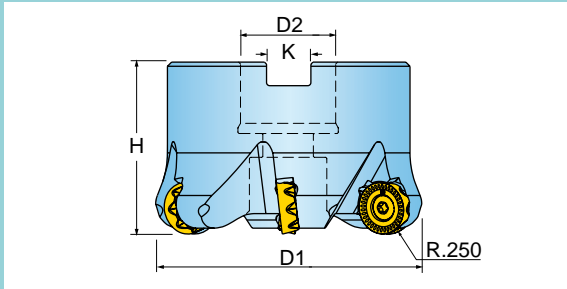

Cutter Number	D1 Nominal Diameter	Number of Inserts	H Height	D2 Bore Dia.	K Keyway	Ramp Angle
5W6J-20R01	2.000	5	1.570	0.750	0.312	7.5
5W6J-20R10	2.000	3	1.570	0.750	0.312	7.5
5W6J-20R12	2.000	3	2.000	1.250 Hi-Tork™*	NA	4.0
5W6J-30R01	3.000	6	1.750	1.000	0.375	5.0
5W6J-40R01	4.000	7	2.500	1.500	0.625	3.0
5W6J-50R01	5.000	8	2.500	1.500	0.625	2.5
5W6J-60R01	6.000	9	2.500	1.500	0.625	2.0

*Hi-Tork is a trademark of Precision Components
Operating guidelines on [page 376](#).

INSERTS

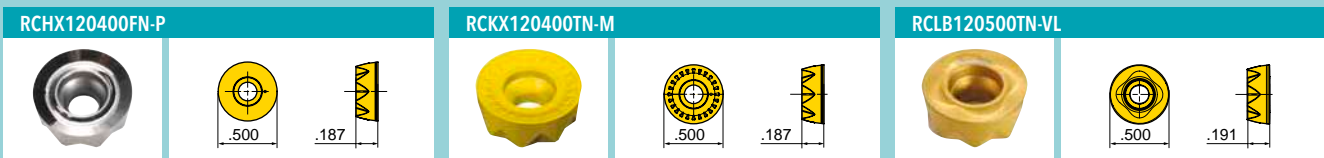





Part Number	Applications	Grade	IN10K	IN2005	IN2030	IN2040	IN2505	IN5515	IN6530		

RCHX120400FN-P	Grd/Pol for Al - 0.250" R		●								
RCKX120400TN-M	Standard - 0.250" R			●	●		●	●			
RCLB120500TN-VL	Heavy-Duty - 0.250" R			●		●			●		

● = P ● = M ● = K ● = N ● = S ● = H

HARDWARE

					
	Screw	Driver	Set Screw	Retention Bolt	(Optional) Coolant Bolt
5W6J-20R01	SM35-110-00	DS-T15T	-	SD-06-46	SD-06-89
5W6J-20R10	SM35-110-00	DS-T15T	-	SD-06-46	SD-06-89
5W6J-20R12	SM35-110-00	DS-T15T	SA-06-37	-	-
5W6J-30R01	SM35-110-00	DS-T15T	-	SD-08-46	SD-08-92
5W6J-40R01	SM35-110-00	DS-T15T	-	SD-12-82	SD-12-99
5W6J-50R01	SM35-110-00	DS-T15T	-	SD-12-82	SD-12-99
5W6J-60R01	SM35-110-00	DS-T15T	-	SD-12-82	SD-12-99

CERAMIC BUTTON END MILL, .500 IC BUTTON

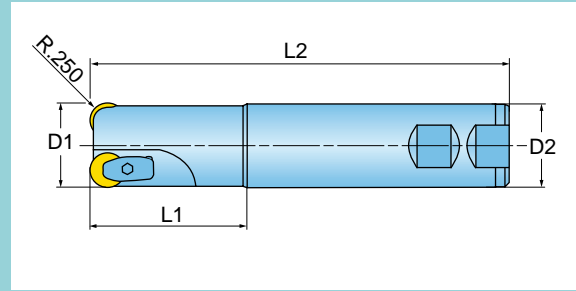

Cutter Number	D1 Nom. Dia.	L1 Extension Length	L2 Overall Length	D2 Shank Size/Style	Number of Inserts	Ramp Angle
1DB1H-1203181R01	1.250	3.15	5.51	1.250" Weldon	3	12
1DB1H-1501581R01	1.500	1.48	3.94	1.250" Weldon	3	10

Operating guidelines on [page 374](#).

INSERTS

RPGX43CH				

Part Number	Applications	Grade	IN72N							
-------------	--------------	-------	-------	--	--	--	--	--	--	--

RPGX43CH Neutral Geometry - 0.250" R ●

● = P ● = M ● = K ● = N ● = S ○ = H

HARDWARE				

CCL5M **DSP4** **DLS4-18L** **L-W3**

CERAMIC BUTTON FACE MILL, .500 IC BUTTON

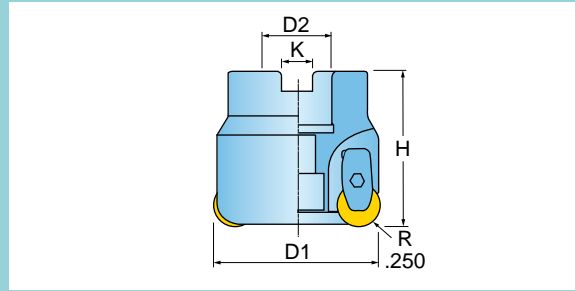

Cutter Number	D1 Nominal Diameter	Number of Inserts	H Height	D2 Bore Dia.	K Keyway	Ramp Angle
DW1H-20R01	2.000	4	1.570	0.750	0.312	.3
DW2H-20R01	2.000	3	1.570	0.750	0.312	.3
DW2H-30R01	3.000	5	1.750	1.000	0.375	.3

Operating guidelines on [page 374](#).

INSERTS

RNGX45CH



Part Number

Applications

Grade

IN72N

RNGX45CH

Neutral Geometry - 0.250" R



● = P ● = M ● = K ● = N ● = S ○ = H

HARDWARE



Clamp

CCL5M



Clamp Spring

DSP4



Clamp Screw

DLS4-18L



Allen Wrench

L-W3

TOROID BUTTON END MILL, .75 IC BUTTON

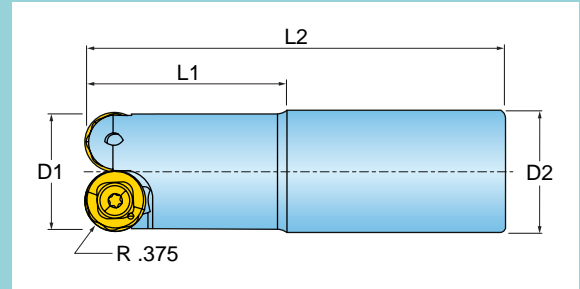

Cutter Number	D1 Nom. Dia.	L1 Extension	Number of Inserts	L2 Overall Length	D2 Shank Size/Style	Coolant Thru	Ramp Angle
15B4M-1502586R01	1.500	2.50	2	5.16	1.500" Weldon	No	6.3
15B4M-1503555R01	1.500	3.50	2	7.50	1.500" Cylindrical	No	6.3

Operating guidelines on [page 374](#).

TOROID BUTTON, TOP-ON, .75 IC BUTTON

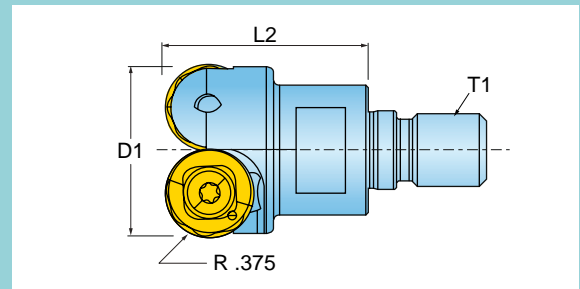

Cutter Number	D1 Nominal Diameter	Cutting Edge Length	No. of Inserts	L2 Extension Length	T1 Thread Size	Coolant Thru	Ramp Angle	Wrench Size
15B4M-15017X8R01	1.000	0.375	2	2.00	M16	No	6.3	22mm

For Top-On shanks and adaptors, see [pages 730-737](#).
Operating guidelines on [page 374](#).

BUTTON FACE MILL, .750 IC BUTTON



Shoulder



Channel



Ramping



Corkscrew



Facing



Contour



Coolant Thru

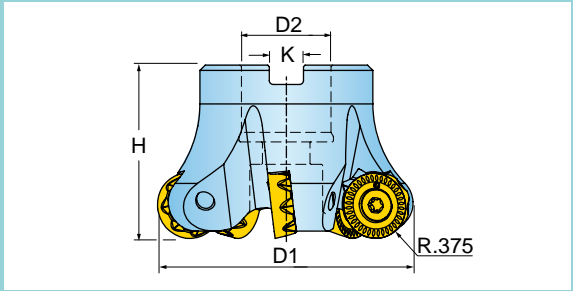

Cutter Number	D1 Nominal Diameter	Number of Inserts	H Height	D2 Bore Dia.	K Keyway	Ramp Angle	Coolant
5W6N-30R01	3.000	5	1.975	1.000	0.375	8.5	Yes
5W6N-40R01	4.000	6	2.480	1.500	0.625	4.5	Yes
5W6N-60R01	6.000	8	2.375	1.500	0.625	2.7	No

Operating guidelines on [page 376](#).

INSERTS

RCLB19T600TN-VL

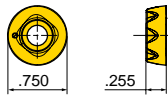

RCLT190600N-HR

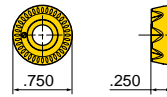

Part Number	Applications	Grade									
			IN2005	IN2030	IN2040	IN6530					
RCLB19T600TN-VL	Heavy-Duty - 0.375" R		●		●	●					
RCLT190600N-HR	Standard - 0.375" R		●	●	●						

● = P ● = M ● = K ● = N ● = S ○ = H

HARDWARE



Screw



Driver



Retention Bolt



(Optional) Coolant Bolt

5W6N-30R01	SM60-150-00	DS-T25T	SD-08-46	SD-08-92
5W6N-40R01	SM60-150-00	DS-T25T	SD-12-42	SD-12-99
5W6N-60R01	SM60-150-00	DS-T25T	-	-
15B4M-1502	SM60-127-00	DS-T25T	-	-
15B4M-1503	SM60-127-00	DS-T25T	-	-
15B4M-15017	SM60-127-00	DS-T25T	-	-

BUTTON FACE MILL

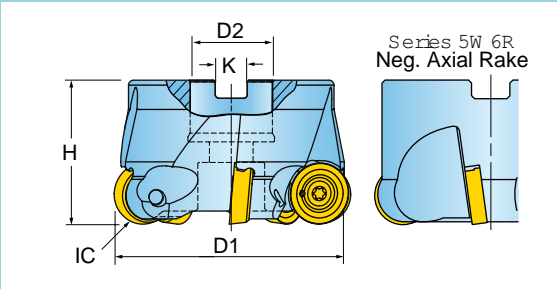

Cutter Number	D1 Nominal Diameter	Insert Inscribed Circle	Number of Inserts	H Height	D2 Bore Diameter	K Keyway	Ramp Angle
5W6H-20R01	2.00	0.500	4	1.625	0.750	0.312	5
5W6H-20R02	2.00	0.500	3	1.625	0.750	0.312	5
5W6H-25R01	2.50	0.500	5	1.625	0.750	0.312	3.5
5W6H-30R01	3.00	0.500	6	1.750	1.000	0.375	2.5
5W6M-30R01	3.00	0.750	5	1.750	1.000	0.375	4
5W6M-30R02	3.00	0.750	4	1.750	1.000	0.375	4
5W6H-40R01	4.00	0.500	7	2.000	1.250	0.500	2
5W6M-40R01	4.00	0.750	6	2.000	1.250	0.500	2.5
5W6M-40R02	4.00	0.750	5	2.000	1.250	0.500	2.5
5W6R-40R01	4.00	1.000	5	2.500	1.500	0.625	1.75
5W6M-60R01	6.00	0.750	8	2.375	1.500	0.625	1.5
5W6M-60R02	6.00	0.750	7	2.375	1.500	0.625	1.5
5W6R-60R01	6.00	1.000	7	2.500	1.500	0.625	3.5

Operating guidelines on [page 376](#).

INSERTS

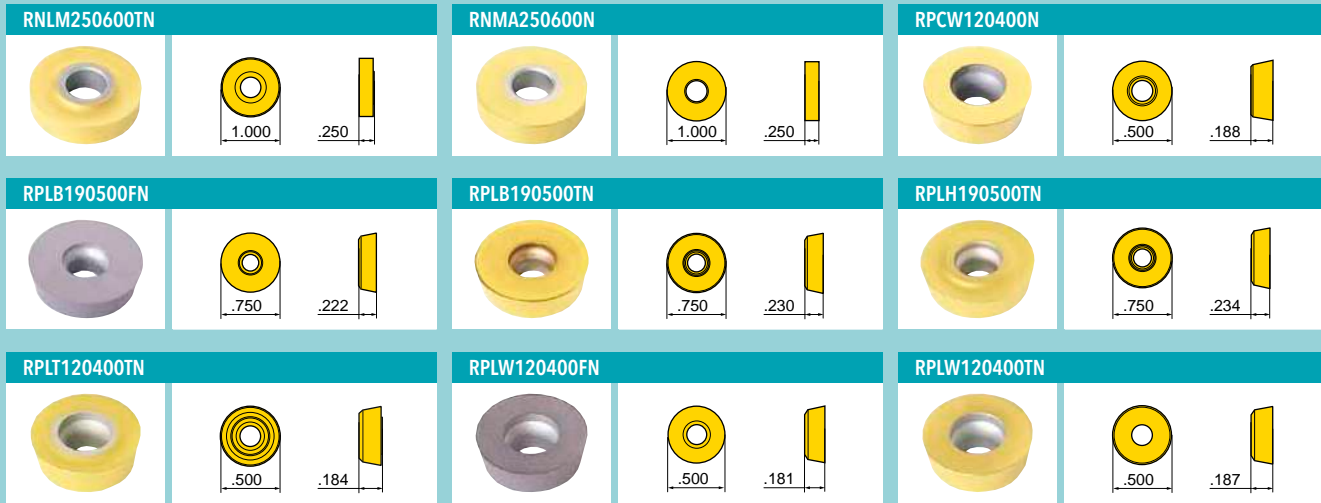

Part Number	Applications	Grade							
			IN1530	IN1540	IN2030	IN2040	IN40P	IN6530	
RNLM250600TN	Multi-Purpose - 0.500" R		●	●	●		●	●	
RNMA250600N	Heavy-Duty - 0.500" R			●			●		
RPCW120400N	Multi-Purpose - 0.250" R		●		●				
RPLB190500FN	Multi-Purpose - 0.375" R				●				
RPLB190500TN	Multi-Purpose - 0.375" R		●		●			●	
RPLH190500TN	Multi-Purpose - 0.375" R		●	●	●	●	●	●	
RPLT120400TN	Precision - 0.250" R		●	●	●	●	●	●	
RPLW120400FN	Multi-Purpose - 0.250" R				●				
RPLW120400TN	Multi-Purpose - 0.250" R		●		●			●	

● = P ● = M ● = K ● = N ● = S ○ = H

HARDWARE



Screw



Driver



Retention Bolt



Allen Wrench

	Screw	Driver	Retention Bolt	Allen Wrench
5W6H-20R01	SM40-120-20	DS-T15T	SD-06-46	-
5W6H-20R02	SM40-120-20	DS-T15T	SD-06-46	-
5W6H-25R01	SM40-120-20	DS-T15T	SD-06-46	-
5W6H-30R01	SM40-093-20	DS-T15T	SD-08-46	-
5W6M-30R01	SM50-127-10	DS-T20T	SD-08-46	-
5W6M-30R02	SM50-127-10	DS-T20T	SD-08-46	-
5W6H-40R01	SM40-120-20	DS-T15T	SD-10-47	-
5W6M-40R01	SM50-127-10	DS-T20T	SD-10-47	-
5W6M-40R02	SM50-127-10	DS-T20T	SD-10-47	-
5W6R-40R01	SC-04-17	-	SD-12-82	WS-0022
5W6M-60R01	SM50-127-10	DS-T20T	SD-12-82	-
5W6M-60R02	SM50-127-10	DS-T20T	SD-12-82	-
5W6R-60R01	SC-04-17	-	SD-12-82	WS-0022

FORMMASTER™ SERIES 15W4S (INNO-FIT STYLE)

TOROID BUTTON END MILL, 1.00 IC BUTTON

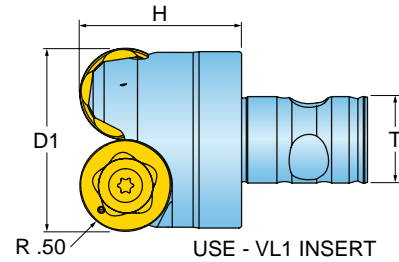

Cutter Number	D1 Nominal Diameter	H Extension Length	T Shank Size/Style	No. of Inserts	Ramp Angle
15W4S-20017Z4R01	2.000	1.75	SK40	2	75.0 (max)

For Inno Fit master shanks and adaptors, see pages 726-729. Operating guidelines on page 376.

FORMMASTER™ SERIES 5W6 (HI TORK STYLE)

TOROID BUTTON FACE MILL, 1.00 IC BUTTON

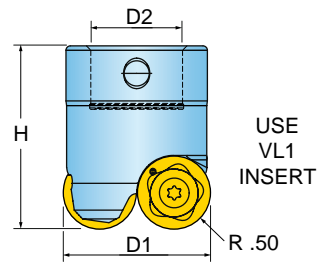

Cutter Number	D1 Effective Diameter	Number of Inserts	H Height	D2 Bore Diameter	Ramp Angle
5W6S-20R01	2.000	2	2.500	1.25" Hi-Tork™*	75.0 (max)

Operating guidelines on page 376. *Hi-Tork is a trademark of Precision Components

INSERTS

RPLB250700TN-VL1

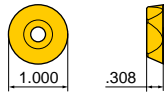

Part Number

Applications

Grade

IN2030

IN2040

RPLB250700TN-VL1

Heavy-Duty - 0.500" R



● = P ● = M ● = K ● = N ● = S ○ = H

HARDWARE



Screw



Driver



Set Screw

15W4S-20017Z4R01

SE25-063-10

DS-T25T

SA-06-37

5W6S-20R01

SE25-063-10

DS-T25T

-

BUTTON FACE MILL, 1.00 BUTTON



Channel



Ramping



Pocket



Facing



Contour

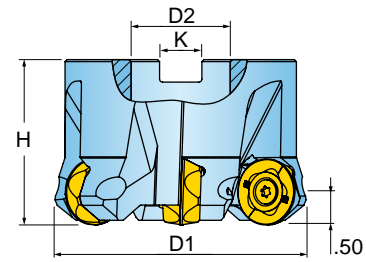

Cutter Number	D1 Effective Diameter	Number of Inserts	H Height	D2 Bore Dia.	K Keyway	Ramp Angle
5W6S-40R01	4.000	5	2.500	1.500	0.625	6.3
5W6S-40R02	4.000	6	2.500	1.500	0.625	6.3
5W6S-40R20	4.000	6	2.500	1.500	0.625	6.3
5W6S-60R01	6.000	7	2.500	1.500	0.625	3.5
5W6S-60R02	6.000	8	2.500	1.500	0.625	3.5
5W6S-60R20	6.000	8	2.500	1.500	0.625	3.5

Operating guidelines on [page 376](#).

INSERTS

RPLB250700FN

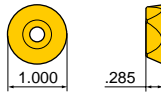
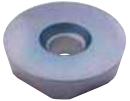

RPLB250700TN-VL

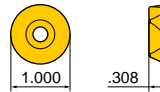

Part Number	Applications	Grade	IN2030	IN2040	IN6530						
-------------	--------------	-------	--------	--------	--------	--	--	--	--	--	--

RPLB250700FN Multi-Purpose - 0.500" R



RPLB250700TN-VL Heavy-Duty - 0.500" R



● = P ● = M ● = K ● = N ● = S ○ = H

HARDWARE



Screw



Driver



Retention Bolt

SE25-063-10

DS-T25T

SD-12-82

BUTTON CUTTER

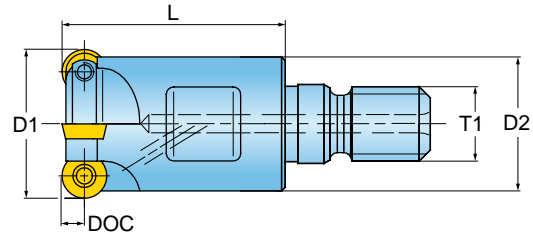







Cutter Number	D1 Nominal Diameter	No. of Inserts	L Head Length	T1 Thread Size	Insert Inscribed Circle	Wrench Size	D2 Adapter Diameter	Ramp Angle
15B1D016023X5R00	16mm	3	23mm	M8	6mm	10mm	13mm	5.0
15B1E016023X5R00	16mm	2	23mm	M8	8mm	10mm	13mm	40.0
15B1E-07512X6R01	0.750	2	1.25	M10	8mm	15mm	18mm	8.0
15B1D020030X6R00	20mm	4	30mm	M10	6mm	15mm	18mm	10.0
15B1G020030X6R00	20mm	2	30mm	M10	10mm	15mm	18mm	40.0
15B1D025035X7R00	25mm	5	35mm	M12	6mm	17mm	21mm	7.0
15B1G025035X7R00	25mm	2	35mm	M12	10mm	17mm	21mm	17.0
15B1G-10012X7R01	1.000	3	1.25	M12	10mm	17mm	21mm	10.0
15B1H-10015X7R01	1.000	2	1.50	M12	12mm	17mm	21mm	10.0
15B1E030043X8R00	30mm	5	43mm	M16	8mm	22mm	29mm	8.0
15B1G030043X8R00	30mm	4	43mm	M16	10mm	22mm	29mm	11.0
15B1H-12015X8R01	1.250	3	1.50	M16	12mm	22mm	29mm	5.0
15B1K-12015X8R01	1.250	2	1.50	M16	16mm	22mm	29mm	5.0
15B1K032043X8R00	32mm	2	43mm	M16	16mm	22mm	29mm	40.0
15B1G035043X8R00	35mm	4	43mm	M16	10mm	22mm	29mm	8.0
15B1H035043X8R00	35mm	3	43mm	M16	12mm	22mm	29mm	11.0
15B1G-15012X8R01	1.500	5	1.25	M16	10mm	22mm	29mm	5.0
15B1H-15015X8R01	1.500	3	1.50	M16	12mm	22mm	29mm	5.0
15B1G042043X8R00	42mm	5	43mm	M16	10mm	22mm	29mm	6.0
15B1H042043X8R00	42mm	4	43mm	M16	12mm	22mm	29mm	8.0

For Top-On shanks and adaptors, see [pages 730-737](#).
Operating guidelines on [page 374](#).

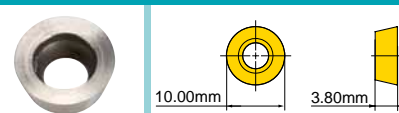
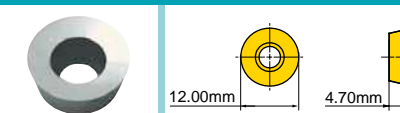
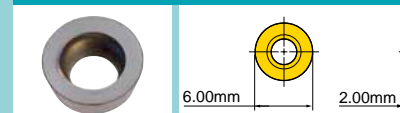
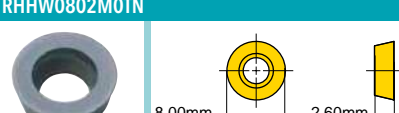
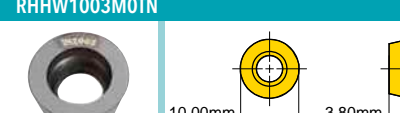



Part Number	Applications	Grade								
			IN05S	IN2004	IN2005	IN2006	IN2015	IN2030	IN2040	
RHHT1003M0FN-P	Grd/Pol for Al - 5.0 mm R	●								
RHHT1204M0FN-P	Grd/Pol for Al - 6.0 mm R	●								
RHHT1605M0FN-P	Grd/Pol for Al - 8.0 mm R	●								
RHHW0602M0TN	Precision - 3.0 mm R			●	●	●				
RHHW0802M0TN	Precision - 4.0 mm R			●	●		●			
RHHW1003M0TN	Precision - 5.0 mm R			●	●	●	●		●	
RHHW1204M0TN	Precision - 6.0 mm R			●	●	●	●		●	
RHHW1605M0TN	Precision - 8.0 mm R			●	●	●	●		●	
RHKW1003M0TN	Multi-Purpose - 5.0 mm R			●	●	●	●		●	
RHKW1204M0TN	Multi-Purpose - 6.0 mm R			●	●	●	●		●	
RHKW1605M0TN	Multi-Purpose - 8.0 mm R			●	●	●	●	●	●	

● = P ● = M ● = K ● = N ● = S ○ = H

INSERTS

RHHT1003M0FN-P		RHHT1204M0FN-P		RHHW0602M0TN	
RHHW0802M0TN		RHHW1003M0TN		RHHW1204M0TN	
RHHW1605M0TN		RHKW1003M0TN		RHKW1204M0TN	
RHKW1605M0TN		RHHT1605M0FN-P			

HARDWARE

					
	Screw	Driver	Driver	Insert Clamp	Clamp Screw
15B1D016023X5R00	SM25-049-00	-	DS-T09W	-	-
15B1E016023X5R00	SM30-053-00	-	DS-T09W	-	-
15B1E-07512X6R01	SM30-053-00	-	DS-T09W	-	-
15B1D020030X6R00	SM25-049-00	-	DS-T08W	-	-
15B1G020030X6R00	SM40-070-00	DS-T15T	-	-	-
15B1D025035X7R00	SM25-049-00	-	DS-T08W	-	-
15B1G025035X7R00	SM40-070-00	DS-T15T	-	-	-
15B1G-10012X7R01	SM40-070-00	DS-T15T	-	-	-
15B1H-10015X7R01	SM40-080-10	DS-T15T	-	-	SF035-01
15B1E030043X8R00	SM30-053-00	DS-T15T	-	-	-
15B1G030043X8R00	SM40-070-00	-	DS-T09W	-	-
15B1H-12015X8R01	SM40-080-10	DS-T15T	-	-	SF035-01
15B1K-12015X8R01	SM50-100-10	DS-T15T	-	CL-5000	-
15B1K032043X8R00	SM50-100-10	-	DS-T09W	CL-5000	-
15B1G035043X8R00	SM40-070-00	DS-T15T	-	-	-
15B1H035043X8R00	SM40-080-10	DS-T15T	-	-	SF035-01
15B1G-15012X8R01	SM40-070-00	DS-T15T	-	-	-
15B1H-15015X8R01	SM40-080-10	DS-T15T	-	-	SF035-01
15B1G042043X8R00	SM40-070-10	DS-T15T	-	-	-
15B1H042043X8R00	SM40-080-10	DS-T15T	-	-	SF035-01

BUTTON CUTTERS

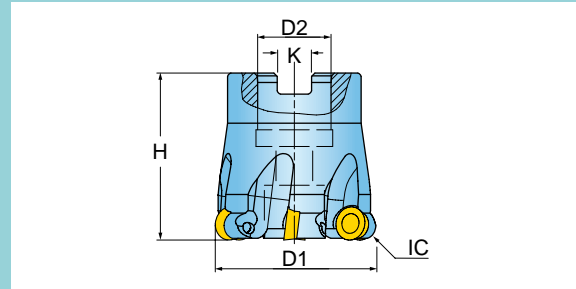

Cutter Number	D1 Nominal Diameter	No. of Inserts	D2 Bore Dia.	H Height	K Keyway	Insert Inscribed Circle	Ramp Angle
5W7G-20R01	2.000	6	0.750	1.625	0.312	10mm	4.5
5W7H-20R01	2.000	5	0.750	1.625	0.312	12mm	5.0
5W7K-20R01	2.000	4	0.750	2.000	0.312	16mm	6.0
5W7H-25R01	2.500	6	0.750	1.625	0.312	12mm	4.0
5W7H-30R01	3.000	7	1.000	2.000	0.375	12mm	3.0
5W7K-30R01	3.000	6	1.000	2.000	0.375	16mm	5.5
5W7K-40R01	4.000	7	1.250	2.000	0.500	16mm	3.5
5W7M-40R01	4.000	7	1.500	2.500	0.625	20mm	4.0
5W7K-50R01	5.000	8	1.500	2.500	0.625	16mm	2.5
5W7K-60R01	6.000	9	1.500	2.500	0.625	16mm	2.0
5W7M-60R01	6.000	9	1.500	2.500	0.625	20mm	2.0

Operating guidelines on [page 375](#).



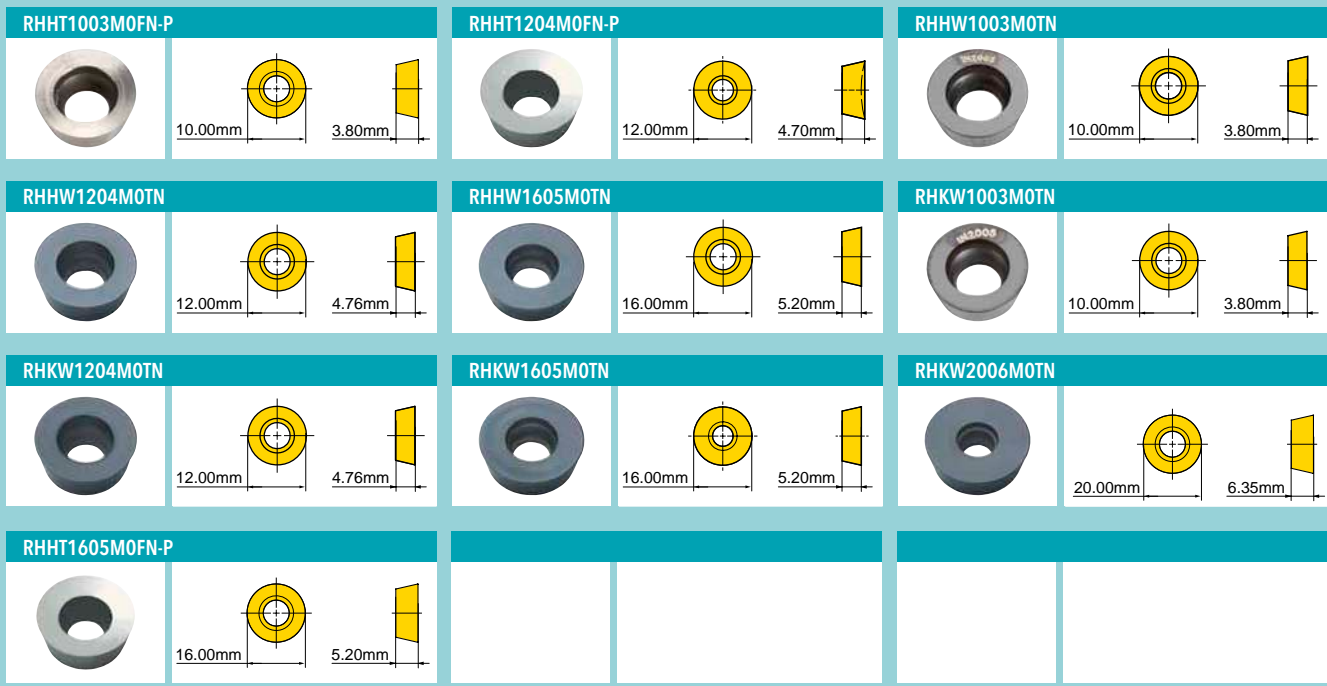

INSERTS



Part Number	Applications	Grade	IN05S	IN2004	IN2005	IN2006	IN2015	IN2030	IN2040		
RHHT1003M0FN-P	Grd/Pol for Al - 5.0 mm R		●								
RHHT1204M0FN-P	Grd/Pol for Al - 6.0 mm R		●								
RHHT1605M0FN-P	Grd/Pol for Al - 8.0 mm R		●								
RHHW1003M0TN	Precision - 5.0 mm R			●	●	●	●		●		
RHHW1204M0TN	Precision - 6.0 mm R			●	●	●	●		●		
RHHW1605M0TN	Precision - 8.0 mm R			●	●		●		●		
RHKW1003M0TN	Multi-Purpose - 5.0 mm R				●		●		●		
RHKW1204M0TN	Multi-Purpose - 6.0 mm R			●	●		●		●		
RHKW1605M0TN	Multi-Purpose - 8.0 mm R			●	●		●	●	●		
RHKW2006M0TN	Multi-Purpose - 10.0 mm R						●	●	●		

● = P ● = M ● = K ● = N ● = S ● = H

HARDWARE

					
	Screw	Driver	Insert Clamp	Retention Bolt	Clamp Screw
5W7G-20R01	SM40-080-10	DS-T15T	-	SD-06-46	-
5W7H-20R01	SM40-080-10	DS-T15T	-	SD-06-46	SF035-01
5W7K-20R01	SM50-100-10	DS-T20T	CL-5000	SD-06-48	-
5W7H-25R01	SM40-080-10	DS-T15T	-	SD-06-46	SF035-01
5W7H-30R01	SM40-080-10	DS-T15T	-	SD-08-46	SF035-01
5W7K-30R01	SM50-100-10	DS-T20T	CL-5000	SD-08-48	-
5W7K-40R01	SM50-100-10	DS-T20T	CL-5000	SD-10-47	-
5W7M-40R01	SM50-100-10	DS-T20T	CL-5000	SD-12-82	-
5W7K-50R01	SM50-100-10	DS-T20T	CL-5000	SD-12-82	-
5W7K-60R01	SM50-100-10	DS-T20T	CL-5000	SD-12-82	-
5W7M-60R01	SM50-100-10	DS-T20T	CL-5000	SD-12-82	-

HIGH FEED MODULAR END MILL WITH 2 INDEXES

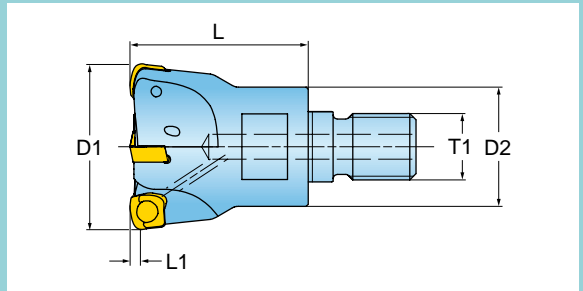

Cutter Number	D1 Nominal Diameter	No. of Inserts	L1 Max DOC	D2 Adaption Diameter	L Head Length	T1 Thread Size	Wrench Size	Insert Series	Ramp Angle
15V1E-07012X6R01	0.750	2	0.06	0.70	1.25	M10	15mm	UHLD08	4.5
15V1E020030X6R00	20mm	2	0.06	18mm	30mm	M10	15mm	UHLD08	5.3
15V1E025035X7R01	25mm	3	0.06	21mm	35mm	M12	17mm	UHLD08	3.5
15V1E-10012X7R01	1.000	2	0.06	0.82	1.25	M12	17mm	UHLD08	3.5
15V1E-10012X7R02	1.000	3	0.06	0.82	1.25	M12	17mm	UHLD08	3.5
15V1E-12015X8R01	1.250	3	0.06	1.14	1.50	M16	22mm	UHLD08	2.5
15V1H-12015X8R01	1.250	2	0.08	1.14	1.50	M16	22mm	UHLD13	2.5
15V1H-15017X8R01	1.500	3	0.08	1.14	1.75	M16	22mm	UHLD13	1.5
15V1E042043X8R00	42mm	4	0.06	29mm	43mm	M16	22mm	UHLD08	1.7

For Top-On shanks and adaptors, see [pages 730-737](#).
Operating guidelines on [page 370](#).

INSERTS

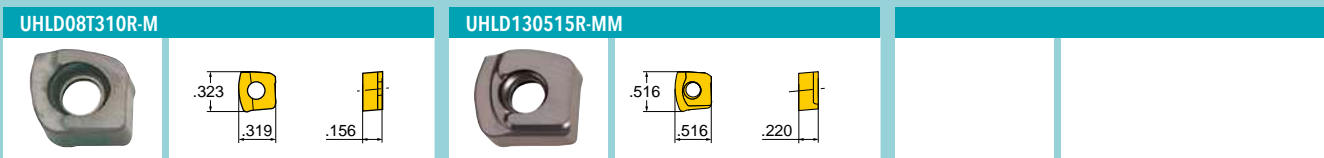



Part Number	Applications	Grade	IN2005	IN2030	IN2040	IN2505	IN2540			

UHLD08T310R-M	High-Feed - 0.118" R*									
UHLD130515R-MM	High-Feed - 0.118" R*									

* Program Radius ● = P ● = M ● = K ● = N ● = S ○ = H

HARDWARE

			
	Screw	Driver	Driver
15V1E-07012X6R01	SM25-075-60	-	DS-TP08S
15V1E020030X6R00	SM25-075-60	-	DS-TP08S
15V1E025035X7R01	SM25-075-60	-	DS-TP08S
15V1E-10012X7R01	SM25-075-60	-	DS-TP08S
15V1E-10012X7R02	SM25-075-60	-	DS-TP08S
15V1E-12015X8R01	SM25-075-60	-	DS-TP08S
15V1H-12015X8R01	SM40-120-20	DS-T15T	-
15V1H-15017X8R01	SM40-120-20	DS-T15T	-
15V1E042043X8R00	SM25-075-60	-	DS-TP08S

HI FEED FACEMILL WITH 2 INDEXES



Ramping



Corkscrew



Pocket



Facing



Contour



Coolant

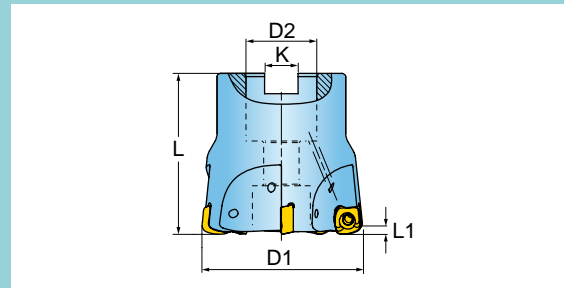



Cutter Number	D1 Nominal Diameter	Number of Inserts	D3 Bore Dia.	L Height	K Keyway	L1 Max. DOC	Insert Series	Ramp Angle
5V6E-20R01	2.000	5	0.750	1.625	0.312	0.06	UHLD08	1
5V6H-20R01	2.000	4	0.750	1.625	0.312	0.08	UHLD13	1.
5V6H-30R01	3.000	5	1.000	2.000	0.375	0.08	UHLD13	.5
5V6H-40R01	4.000	6	1.250	2.125	0.500	0.08	UHLD13	.5

Operating guidelines on [page 370](#).

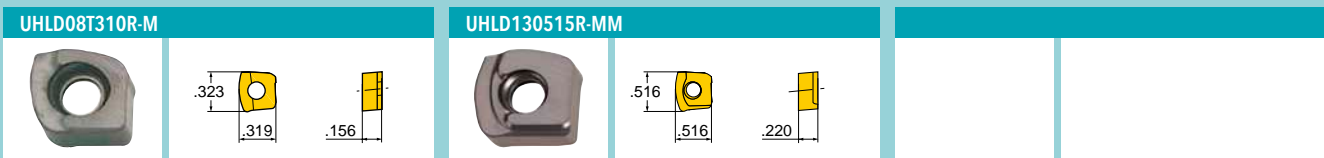
INSERTS







Part Number	Applications	Grade	IN2005	IN2030	IN2040	IN2505	IN2540			
-------------	--------------	-------	--------	--------	--------	--------	--------	--	--	--

UHLD08T310R-M	High-Feed - 0.118" R*									
UHLD130515R-MM	High-Feed - 0.118" R*									

* Program Radius ● = P ● = M ● = K ● = N ● = S ○ = H

HARDWARE

					
	Screw	Driver	Driver	Retention Bolt	(Optional) Coolant Bolt
5V6E-20R01	SM25-075-60	-	DS-TP08S	SD-06-46	SD-06-89
5V6H-20R01	SM40-120-20	DS-T15T	-	SD-06-46	SD-06-89
5V6H-30R01	SM40-120-20	DS-T15T	-	SD-08-46	SD-08-92
5V6H-40R01	SM40-120-20	DS-T15T	-	SD-10-47	SD-10-99

HIGH FEED END MILL WITH 4 INDEXES

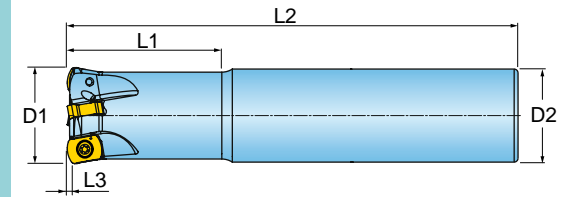

Cutter Number	D1 Nominal Diameter	L1 Extension Length	L2 Overall Length	L3 Max. DOC	D2 Shank Size/Style	Number of Inserts	Ramp Angle
1TG1F-06015ULR01	0.625	1.16	4.00	.027	15.5mm Cylindrical	2	.5
1TG1F-06015S6R01	0.625	1.17	4.00	.027	.625" Cylindrical	2	.5
1TG1F-07017UMR01	0.750	1.43	5.00	.027	18.5mm Cylindrical	3	.5
1TG1F-07017UMR02	0.750	1.43	6.25	.027	18.5mm Cylindrical	3	.5
1TG1F-07022S7R01	0.750	1.94	5.00	.027	.750" Cylindrical	3	.5
1TG1F-07032S7R01	0.750	2.94	6.25	.027	.750" Cylindrical	3	.5
1TG1F-08019UNR01	0.875	1.70	7.75	.039	21.5mm Cylindrical	3	.5
1TG1F-10022T5R01	1.000	1.94	7.00	.039	25mm Cylindrical	4	.5
1TG1F-10022S1R01	1.000	1.94	10.00	.039	1.000" Cylindrical	4	.5
1TG1F-10022T5R02	1.000	1.94	10.00	.039	25mm Cylindrical	4	.5
1TG1F-10032S1R01	1.000	2.94	7.00	.039	1.000" Cylindrical	4	.5
1TG1F-1203281R01	1.250	2.94	5.50	.039	1.250" Weldon	5	.5
1TG1F-12050E2R01	1.250	4.69	8.00	.039	1.250" Weldon	5	.5
1TG1F-15015E2R01	1.500	1.69	6.00	.039	1.250" Weldon	6	.5

Operating guidelines on [page 370](#).

INSERTS

UNLU0603M0TR

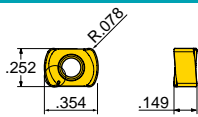

Part Number	Applications	Grade							
		IN2030	IN2505	IN6530					
UNLU0603M0TR	High-Feed - 0.078" R*								

* Program Radius

= P
 = M
 = K
 = N
 = S
 = H

HARDWARE

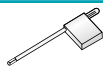

Screw

Driver

SM25-064-00

DS-T08W

HIGH FEED MODULAR END MILL WITH 4 INDEXES

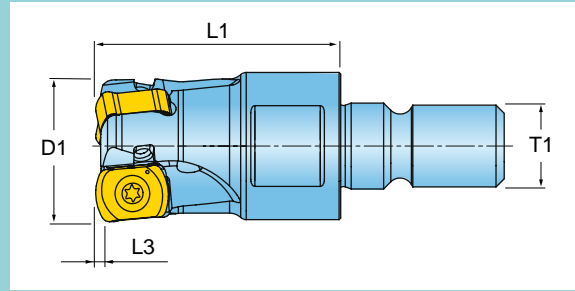

Cutter Number	D1 Nom. Dia.	T1 Adaption	L1 Extension Length	L3 Max. DOC	Number of Inserts	Wrench Size	Ramp Angle
1TG1F-06010X5R01	0.625	M8	0.98	.027	2	10mm	.5
1TG1F-07011X6R01	0.750	M10	1.18	.027	3	15mm	.5
1TG1F-10013X7R01	1.000	M12	1.37	.039	4	17mm	.5
1TG1F-12015X8R01	1.250	M16	1.57	.039	5	22mm	.5

For Top-On shanks and adaptors, see [pages 730-737](#).
Operating guidelines on [page 370](#).

INSERTS

UNLU0603MOTR

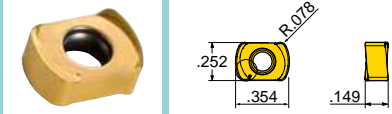

Part Number	Applications	Grade	IN2030	IN2505	IN6530					
-------------	--------------	-------	--------	--------	--------	--	--	--	--	--

UNLU0603MOTR High-Feed - 0.078" R*

* Program Radius

HARDWARE



Screw



Driver

SM25-064-00

DS-T08W

HIGH FEED FACE MILL WITH 4 INDEXES

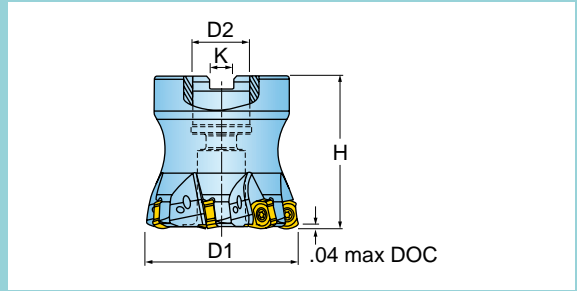

Cutter Number	D1 Effective Diameter	Number of Inserts	H Height	D2 Bore Dia.	K Keyway	Max Ramp Angle
TG1F-20R01	2.000	7	1.968	0.750	0.312	.3
TG1F-30R01	3.000	9	1.750	1.250	0.500	.25

Operating guidelines on [page 370](#).

INSERTS

UNLU0603M0TR			

Part Number	Applications	Grade	IN2030	IN2505	IN6530					
-------------	--------------	-------	--------	--------	--------	--	--	--	--	--

UNLU0603M0TR High-Feed - 0.078" R*

* Program Radius

= P = M = K = N = S = H

HARDWARE				
	Screw	Driver	Retention Bolt	(Optional) Coolant Bolt

TG1F-20R01	SM25-064-00	DS-T08W	SD-06-48	SD-06-89
TG1F-30R01	SM25-064-00	DS-T08W	SD-10-46	SD-10-99

HIGH FEED END MILL WITH 4 INDEXES

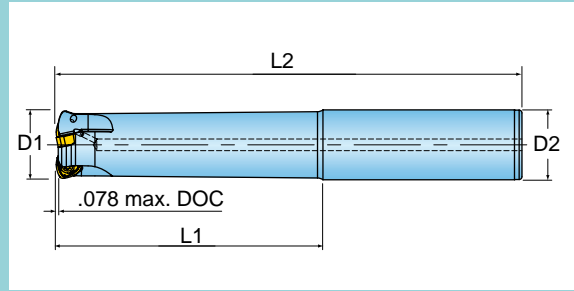

Cutter Number	D1 Nom. Dia.	L1 Extension Length	L2 Overall Length	D2 Shank Size/Style	Number of Inserts	Coolant Thru	Max. Ramp Angle
1DG1H-1202781R01	1.250	2.750	5.00	1.250" Weldon	2	Yes	3.0
1DG1H-1205759R01	1.250	4.750	8.00	1.250" Cylindrical	2	Yes	3.0
1DG1H-1503386R01	1.500	3.310	6.00	1.500" Weldon	3	Yes	1.7
1DG1H-1507355R01	1.500	5.727	10.00	1.500" Cylindrical	3	Yes	1.7

Operating guidelines on [page 372](#).

INSERTS

UNEU1205R

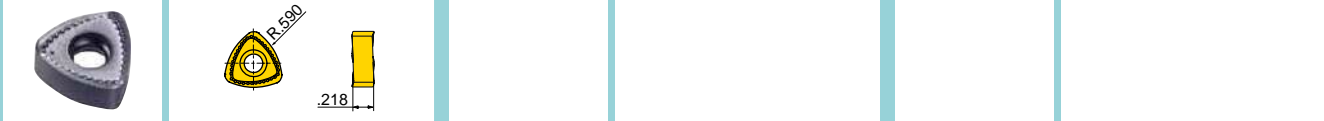

Part Number	Applications	Grade	IN2030	IN2505	IN2540	IN6530				
-------------	--------------	-------	--------	--------	--------	--------	--	--	--	--

UNEU1205R High-Feed - 0.118" R*

* Program Radius

HARDWARE



Screw SM40-120-20 Driver DS-T15T

POWER FEED+™ SERIES 1DG1H (TOP-ON STYLE)

HIGH FEED MODULAR END MILL WITH 6 INDEXES



Shoulder



Ramping



Corkscrew



Pocket



Contour



Plunging



Coolant

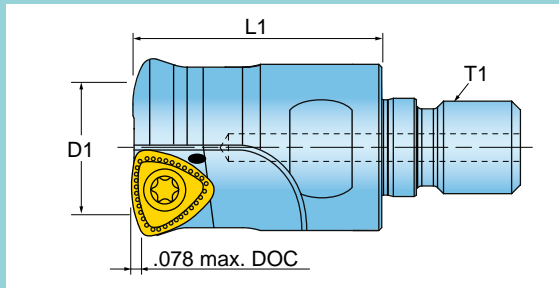

Cutter Number	D1 Nom. Dia.	Number of Inserts	L1 Extension Length	T1 Adaption	Max. Ramp Angle	Wrench Size
1DG1H-12017X8R01	1.250	2	1.75	M16	3	22mm
1DG1H-15017X8R01	1.500	3	1.75	M16	1.75	22mm

For Top-On shanks and adaptors, see [pages 730-737](#).
Operating guidelines on [page 372](#).

INSERTS

UNEU1205R



Part Number	Applications	Grade	IN2030	IN2505	IN2540	IN6530				
-------------	--------------	-------	--------	--------	--------	--------	--	--	--	--

UNEU1205R High-Feed - 0.118" R*



* Program Radius

● = P ● = M ● = K ● = N ● = S ● = H

HARDWARE



Screw



Driver

SM40-120-20

DS-T15T

HIGH FEED FACE MILL WITH 6 INDEXES

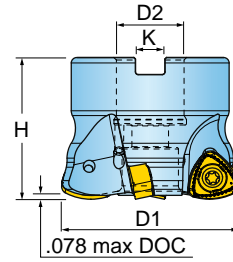

Cutter Number	D1 Effective Diameter	Number of Inserts	H Height	D2 Bore Dia.	K Keyway	Ramp Angle
DG6H-20R01	2.000	3	1.570	0.750	0.312	1.0
DG6H-20R02	2.000	4	1.570	0.750	0.312	1.0
DG6H-25R01	2.500	4	1.570	0.750	0.312	.5
DG6H-30R01	3.000	5	1.750	1.000	0.375	.5
DG6H-30R02	3.000	5	2.000	1.250	0.500	.5
DG6H-40R01	4.000	6	2.375	1.500	0.625	.4
DG6H-60R01	6.000	8	2.375	1.500	0.625	.2

Operating guidelines on [page 372](#).

INSERTS

UNEU1205R



Part Number	Applications	Grade							
			IN2030	IN2505	IN2540	IN6530			

UNEU1205R	High-Feed - 0.118" R*								
-----------	-----------------------	--	--	--	--	--	--	--	--

* Program Radius

HARDWARE



	Screw	Driver	Retention Bolt	(Optional) Coolant Bolt
DG6H-20R01	SM40-120-20	DS-T15T	SD-06-46	SD-06-89
DG6H-20R02	SM40-120-20	DS-T15T	SD-06-46	SD-06-89
DG6H-25R01	SM40-120-20	DS-T15T	SD-06-46	SD-06-89
DG6H-30R01	SM40-120-20	DS-T15T	SD-08-46	SD-08-92
DG6H-30R02	SM40-120-20	DS-T15T	SD-10-47	SD-10-99
DG6H-40R01	SM40-120-20	DS-T15T	SD-12-82	SD-12-99
DG6H-60R01	SM40-120-20	DS-T15T	SD-12-82	SD-12-99

80 DEGREE LEAD HIGH FEED FACE MILL WITH 4 INDEXES

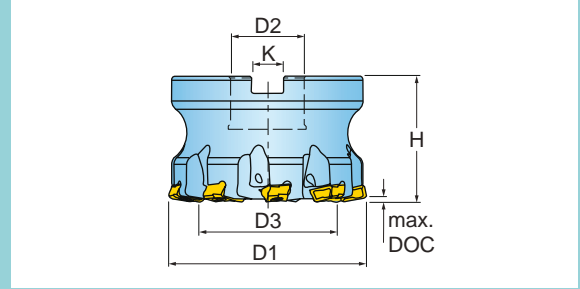

Cutter Number	D1 Nominal Diameter	Effective Inserts	D2 Bore Size	D3 Effective Diameter	Max DOC	Bolt Circle	K Keyway	H Height	Coolant Thru	Insert Series
SP6H-02R01	2.000	5	0.750	1.151	0.08	-	0.310	1.750	Yes	DPM324
SP6H-02R02	2.000	4	0.750	1.151	0.08	-	0.310	1.750	Yes	DPM324
SP6H-03R02	3.000	7	1.000	2.139	0.08	-	0.370	1.750	Yes	DPM324
SP6H-04R02	4.000	9	1.500	3.178	0.08	-	0.630	2.500	Yes	DPM324
SP6N-04R01	4.000	6	1.500	2.929	0.12	-	0.630	2.500	No	DPM434
SP6N-04R02	4.000	7	1.500	2.929	0.12	-	0.630	2.500	Yes	DPM434
SP6N-06R01	6.000	8	1.500	4.922	0.12	-	0.630	2.500	No	DPM434
SP6N-06R02	6.000	9	1.500	4.922	0.12	-	0.630	2.500	Yes	DPM434
SP6N-08R01	8.000	10	2.500	6.922	0.12	4.00	1.000	2.500	No	DPM434
SP6N-08R02	8.000	10	2.500	6.922	0.12	4.00	1.000	2.500	Yes	DPM434

Operating guidelines on [page 372](#).

INSERTS

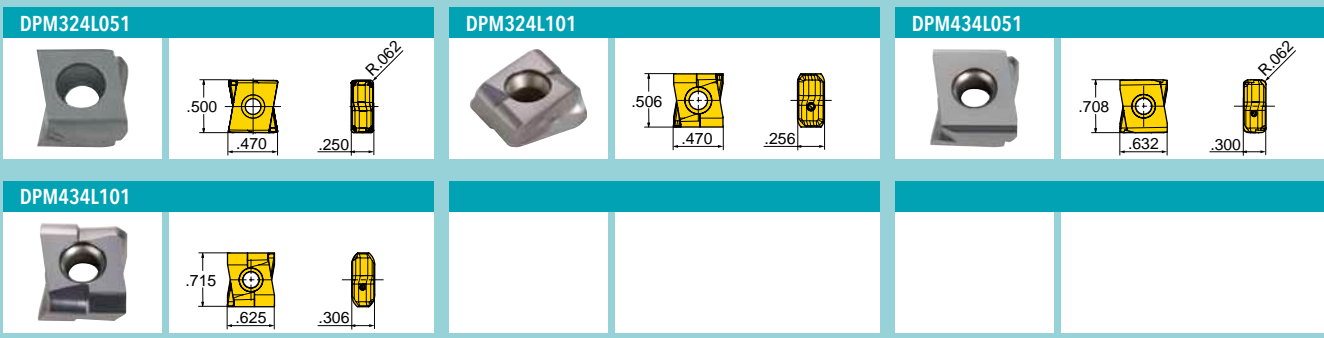

Part Number	Applications	Grade	IN2005	IN2015	IN2030	IN2530					
-------------	--------------	-------	--------	--------	--------	--------	--	--	--	--	--

DPM324L051	Multi-Purpose - 0.062" R										
DPM324L101	Multi-Purpose/Ramping - 0.125" R										
DPM434L051	Multi-Purpose - 0.062" R										
DPM434L101	Multi-Purpose/Ramping - 0.200" R										

= P
 = M
 = K
 = N
 = S
 = H

HARDWARE

	Screw	Driver	Retention Bolt	(Optional) Coolant Bolt
SP6H-02R01	SM40-120-20	DS-T15T	SD-06-46	SD-06-89
SP6H-02R02	SM40-120-20	DS-T15T	SD-06-46	SD-06-89
SP6H-03R02	SM40-120-20	DS-T15T	SD-08-48	SD-08-92
SP6H-04R02	SM40-120-20	DS-T15T	SD-12-82	SD-12-99
SP6N-04R01	SM50-160-10	DS-T20T	SD-12-82	SD-12-99
SP6N-04R02	SM50-160-10	DS-T20T	SD-12-82	SD-12-99
SP6N-06R01	SM50-160-10	DS-T20T	SD-12-82	SD-12-99
SP6N-06R02	SM50-160-10	DS-T20T	SD-12-82	SD-12-99
SP6N-08R01	SM50-160-10	DS-T20T	-	-
SP6N-08R02	SM50-160-10	DS-T20T	SD-10-70	-

HI FEED END MILL WITH UP TO 10 INDEXES

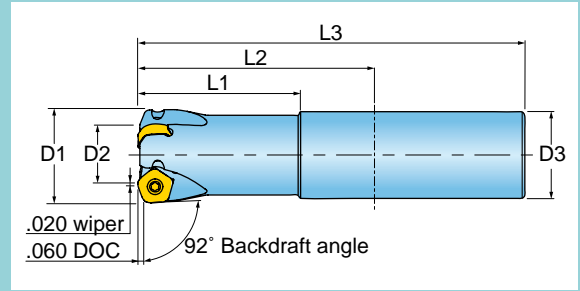

Cutter Number	D1 Nom. Dia.	D2 Min. Dia.	D3 Adaption	L1 Projection Length	L2 Extension Length	L3 OAL Length	Number of Inserts	Ramp Angle
1DP1G-1202781R01	1.250	0.718	1.250" Weldon	2.72	2.75	5.00	2	.15
1DP1G-1205759R01	1.250	0.718	1.250" Weldon	3.50	5.75	8.00	2	.15
1DP1G-1503386R01	1.500	0.968	1.500" Weldon	3.30	3.34	6.00	3	.19
1DP1G-1507355R01	1.500	0.968	1.500" Weldon	4.00	7.34	10.00	3	.19

Operating guidelines on [page 372](#).

INSERTS

PNCQ0804ZNTN

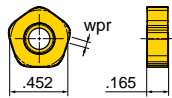

PNCT0804ZNN-HR

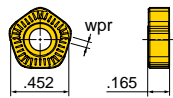

Part Number	Applications	Grade							
		IN2005	IN2030	IN2505					
PNCQ0804ZNTN	Neutral Geometry - 0.180" R*	●	●						
PNCT0804ZNN-HR	Positive Geometry - 0.180" R*		●	●					

* Program Radius

● = P ● = M ● = K ● = N ● = S ○ = H

HARDWARE



Screw



Driver

SM40-093-20

DS-T15T

HI-FEEDDEKA™ SERIES 1DP1G (TOP-ON STYLE)

HIGH FEED MODULAR END MILL WITH UP TO 10 INDEXES



Channel



Ramping



Corkscrew



Facing



Contour



Coolant

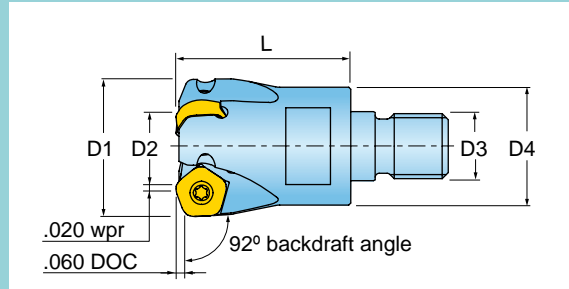

Cutter Number	D1 Eff. Dia.	D2 Min. Dia.	D3 Adaption	D4 Neck Diameter	L Overall Length	Number of Inserts	Ramp Angle	Wrench Size
1DP1G-12015X8R01	1.250	0.718	M16	1.14	1.50	2	0.15	22mm
1DP1G-15017X8R01	1.500	0.968	M16	1.14	1.75	3	0.19	22mm

For Top-On shanks and adaptors, see [pages 730-737](#).
Operating guidelines on [page 372](#).

INSERTS

PNCQ0804ZNTN

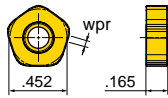

PNCT0804ZNN-HR

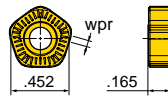

Part Number	Applications	Grade					
		IN2005	IN2030	IN2505			
PNCQ0804ZNTN	Neutral Geometry - 0.180" R*	●	●				
PNCT0804ZNN-HR	Positive Geometry - 0.180" R*		●	●			

* Program Radius

● = P ● = M ● = K ● = N ● = S ○ = H

HARDWARE



Screw



Driver

SM40-093-20

DS-T15T

HIGH FEED FACE MILL WITH UP TO 10 INDEXES

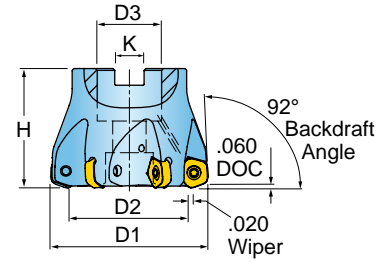

Cutter Number	D1 Effective Diameter	D2 Inner Diameter	D3 Bore Dia.	H Height	Number Effective Inserts	Keyway	Ramp Angle
DP5G-20R01	2.000	1.468	0.750	1.625	5	0.312	0.64
DP5G-20R02	2.000	1.468	0.750	1.625	3	0.312	0.64
DP5G-25R01	2.500	1.968	0.750	1.625	4	0.312	0.74
DP5G-30R01	3.000	2.468	1.000	2.000	4	0.375	0.80
DP5G-40R01	4.000	3.468	1.500	2.375	6	0.625	1.16
DP5G-60R01	6.000	5.468	1.500	2.375	8	0.625	0.72

Operating guidelines on [page 372](#).

INSERTS

PNCQ0804ZNTN

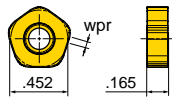

PNCT0804ZNN-HR

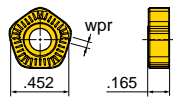

Part Number	Applications	Grade							
			IN2005	IN2030	IN2505				

PNCQ0804ZNTN Neutral Geometry - 0.180" R*



PNCT0804ZNN-HR Positive Geometry - 0.180" R*



* Program Radius

● = P ● = M ● = K ● = N ● = S ○ = H

HARDWARE



Screw

Driver

Retention Bolt

(Optional) Coolant Bolt

DP5G-20R01	SM40-093-20	DS-T15T	SD-06-46	SD-06-89
DP5G-20R02	SM40-093-20	DS-T15T	SD-06-46	SD-06-89
DP5G-25R01	SM40-093-20	DS-T15T	SD-06-46	SD-06-89
DP5G-30R01	SM40-093-20	DS-T15T	SD-06-46	SD-06-89
DP5G-40R01	SM40-093-20	DS-T15T	SD-12-82	SD-12-99
DP5G-60R01	SM40-093-20	DS-T15T	SD-12-82	SD-12-99

12MM IC BUTTON END MILL



Channel

Ramping

Corkscrew

Pocket

Facing

Contour

Coolant

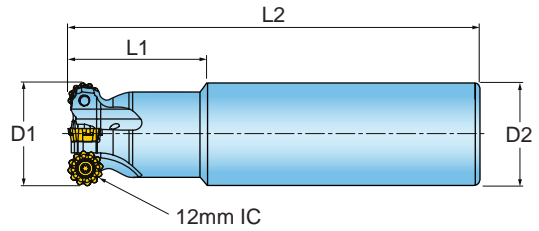

Cutter Number	D1 Effective Diameter	L1 Extension	L2 Overall Length	Number of Inserts	D2 Shank Size/Style
15E1H-1001780R01	1.000	1.75	4.50	2	1.000" Weldon
15E1H-10020S1R01	1.000	2.00	6.00	2	1.000" Cylindrical
15E1H-12020S9R01	1.250	2.25	6.00	3	1.250" Cylindrical
15E1H-1202781R01	1.250	2.75	5.00	3	1.250" Weldon
15E1H-15020S5R01	1.500	2.00	6.00	4	1.500" Cylindrical
15E1H-1502386R01	1.500	2.34	5.00	4	1.500" Weldon

Operating guidelines on [page 378](#).

INSERTS

RCLT1204M0N-CC1

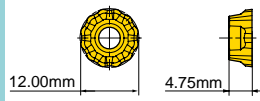

RCLT1204M0N-CC2

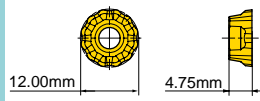

RCLT1204M0N-CP

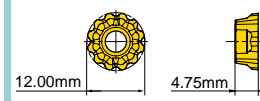

RCLT1204M0TN-PH2

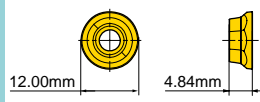

Part Number	Applications	Grade	Grade							
			IN05S	IN2005	IN2015	IN2030	IN2040			
RCLT1204M0N-CC1	Standard - 6.000 mm R									
RCLT1204M0N-CC2	Heavy Duty - 6.000 mm R									
RCLT1204M0N-CP	Grd/Pol for Al - 6.000 mm R									
RCLT1204M0TN-PH2	Heavy Duty - 6.000 mm R									

● = P ● = M ● = K ● = N ● = S ○ = H

HARDWARE



Screw



Driver

SM40-090-00

DS-T15T

BUTTON CUTTER

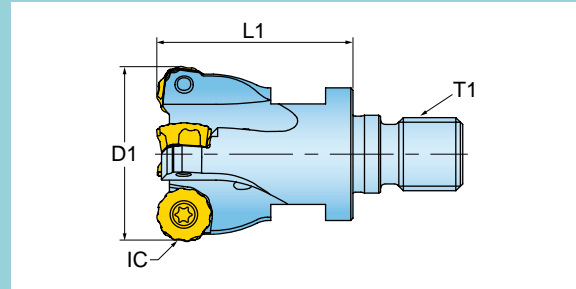

Cutter Number	D1 Effective Diameter	T1 Adaption	Insert Inscribed Circle	L1 Ext. From Holder	Number of Inserts	Wrench Size	Insert Series
15E1H-10015X7R01	1.000	M12	12mm	1.50	2	17mm	RCLT12
15E1H-12015X8R01	1.250	M16	12mm	1.50	3	22mm	RCLT12
15E1K-12017X8R01	1.250	M16	16mm	1.75	2	22mm	RCLT16
15E1H-15015X8R01	1.500	M16	12mm	1.50	4	22mm	RCLT12
15E1K-15017X8R01	1.500	M16	16mm	1.75	3	22mm	RCLT16

For Top-On shanks and adaptors, see [pages 730-737](#).
 Operating guidelines on [page 378](#).

INSERTS

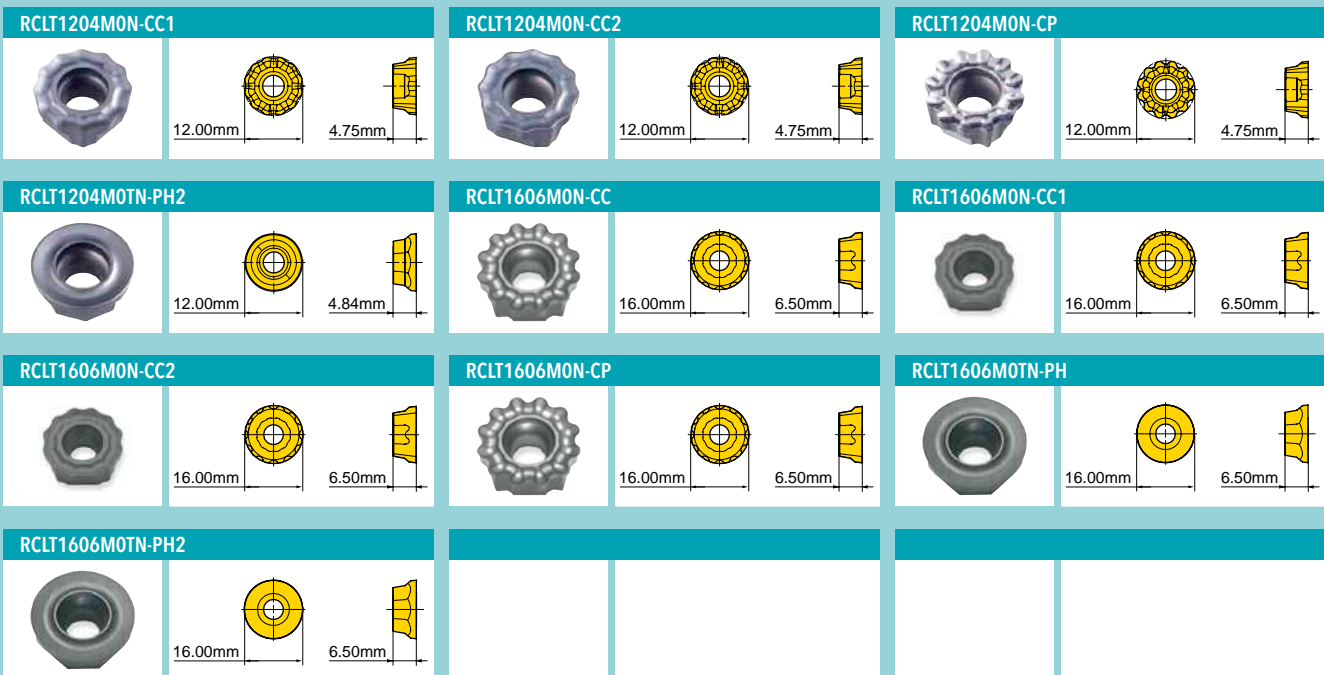

Part Number	Applications	Grade	IN05S	IN2005	IN2015	IN2030	IN2040				
RCLT1204MON-CC1	Standard - 6.0 mm R			●	●	●					
RCLT1204MON-CC2	Heavy-Duty 6.0 mm R			●	●	●					
RCLT1204MON-CP	Grd/Pol for Al - 6.0 mm R		●								
RCLT1204MOTN-PH2	Heavy-Duty 6.0 mm R			●	●	●	●				
RCLT1606MON-CC	Standard - 8.0 mm R			●	●	●					
RCLT1606MON-CC1	Standard - 8.0 mm R			●	●	●					
RCLT1606MON-CC2	Heavy-Duty - 8.0 mm R			●		●					
RCLT1606MON-CP	Grd/Pol for Al - 8.0 mm R		●								
RCLT1606MOTN-PH	Standard - 8.0 mm R			●	●	●					
RCLT1606MOTN-PH2	Heavy-Duty - 8.0 mm R			●	●		●				

● = P ● = M ● = K ● = N ● = S ● = H

HARDWARE



	Screw	Driver
15E1H-10015X7R01	SM40-090-00	DS-T15T
15E1H-12015X8R01	SM40-090-00	DS-T15T
15E1K-12017X8R01	SM50-105-10	DS-T20T
15E1H-15015X8R01	SM40-090-00	DS-T15T
15E1K-15017X8R01	SM50-105-10	DS-T20T

BUTTON CUTTERS



Channel



Ramping



Corkscrew



Facing



Contour



Coolant

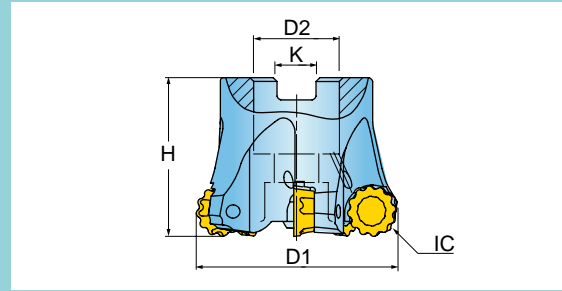

Cutter Number	D1 Nominal Diameter	Number of Inserts	H Height	D2 Bore Dia.	K Keyway	Coolant Thru	Insert Series
5E6H-20R01	2.000	5	1.750	0.750	0.312	Yes	RCLT12
5E6K-02R01	2.000	4	1.750	0.750	0.312	Yes	RCLT16
5E6K-25R10	2.500	5	1.750	0.750	0.312	Yes	RCLT16
5E6K-03R01	3.000	6	1.750	1.000	0.375	Yes	RCLT16
5E6K-04R01	4.000	7	2.000	1.250	0.500	No	RCLT16
5E6K-05R01	5.000	8	2.500	1.500	0.625	No	RCLT16
5E6K-06R01	6.000	9	2.500	1.500	0.625	No	RCLT16

Operating guidelines on [page 378](#).



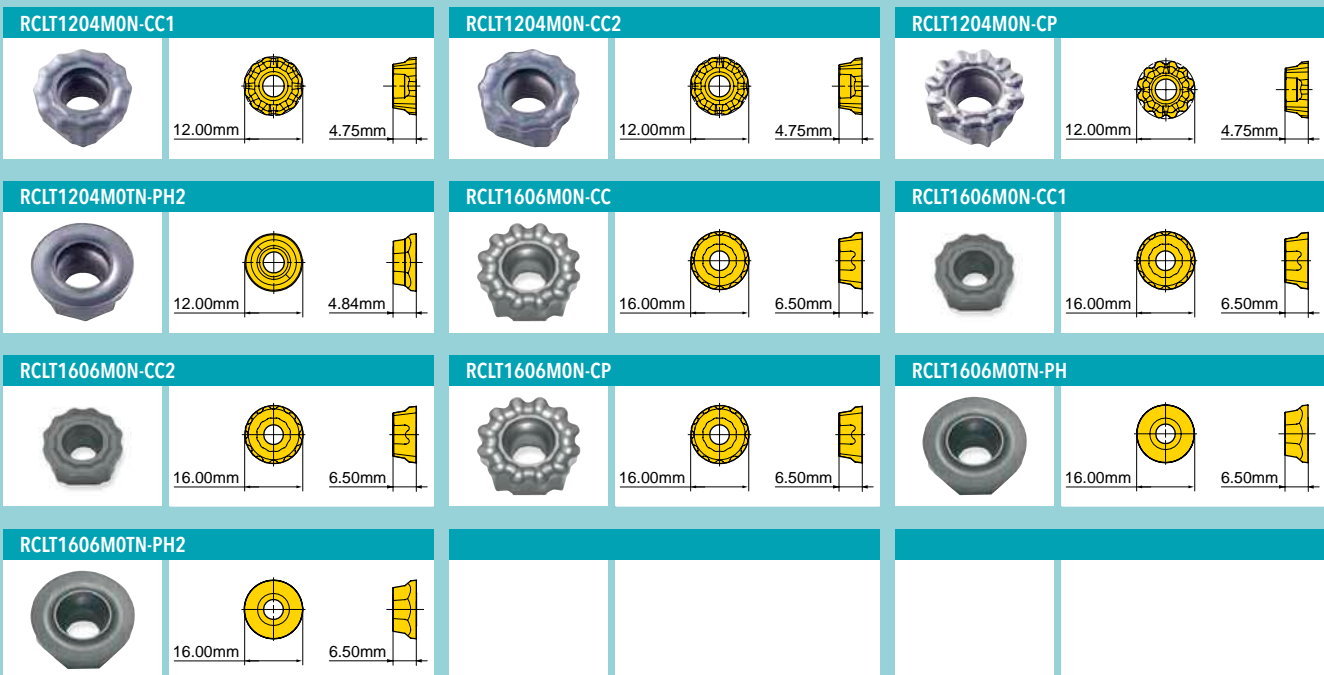

INSERTS



Part Number	Applications	Grade	IN05S	IN2005	IN2015	IN2030	IN2040				
RCLT1204MON-CC1	Standard - 6.0 mm R			●	●	●					
RCLT1204MON-CC2	Heavy-Duty - 6.0 mm R			●	●	●					
RCLT1204MON-CP	Grd/Pol for Al - 6.0 mm R		●								
RCLT1204MOTN-PH2	Heavy-Duty - 6.0 mm R			●	●	●	●				
RCLT1606MON-CC	Standard - 8.0 mm R			●	●	●					
RCLT1606MON-CC1	Standard - 8.0 mm R			●	●	●					
RCLT1606MON-CC2	Heavy-Duty - 8.0 mm R			●		●					
RCLT1606MON-CP	Grd/Pol for Al - 8.0 mm R		●								
RCLT1606MOTN-PH	Standard - 8.0 mm R			●	●	●					
RCLT1606MOTN-PH2	Heavy-Duty - 8.0 mm R			●	●		●				

● = P ● = M ● = K ● = N ● = S ○ = H

HARDWARE

				
	Screw	Driver	Retention Bolt	(Optional) Coolant Bolt
5E6H-20R01	SM40-090-00	DS-T15T	SD-06-46	SD-06-89
5E6K-02R01	SM50-120-10	DS-T20T	SD-06-46	SD-06-89
5E6K-25R10	SM50-120-10	DS-T20T	SD-06-46	SD-06-89
5E6K-03R01	SM50-120-10	DS-T20T	SD-08-46	SD-08-92
5E6K-04R01	SM50-120-10	DS-T20T	SD-10-47	SD-10-99
5E6K-05R01	SM50-120-10	DS-T20T	SD-12-82	SD-12-99
5E6K-06R01	SM50-120-10	DS-T20T	SD-12-82	SD-12-99

BACK DRAFT FINISH END MILL WITH 4 INDEXES

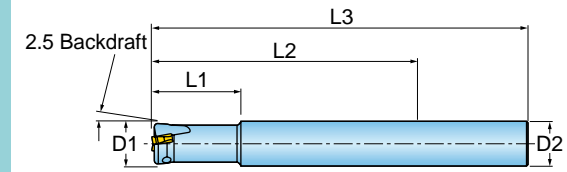

Cutter Number	D1 Nominal Diameter	Insert	L1 Projection Length	L2 Extension Length	L3 Overall Length	D2 Shank Size/Style	Effective Flutes
15V1D-07060S7R02	0.750	CNHU06	3.00	6.00	8.00	.750" Cylindrical	3
15V1D-10057S1R01	1.000	CNHU06	2.87	5.75	8.00	1.000" Cylindrical	3
15V1G-10057S1R01	1.000	CNHU11	2.87	5.75	8.00	1.000" Cylindrical	2

Operating guidelines on [page 371](#).

INSERTS

CNHU060310N

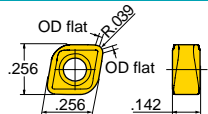

CNHU110420N

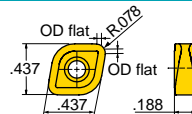

Part Number	Applications	Grade								
			IN1030	IN2005	IN2006	IN2040	IN3005			
CNHU060310N	Finish./Semi-Finish. - 1.000 mm R w/1mm OD flat		●	●	●	●	●			
CNHU110420N	Finish./Semi-Finish. - 2.000 mm R w/2mm OD flat		●	●	●	●	●			

● = P ● = M ● = K ● = N ● = S ○ = H

HARDWARE



Screw

Driver

Driver

15V1D-07060S7R02	SM25-075-20	-	DS-T08W
15V1G-10057S1R01	SM35-088-10	DS-T10T	-
15V1D-10057S1R01	SM25-075-20	-	DS-T08W

BACK DRAFT MODULAR FINISH CUTTER WITH 4 INDEXES



Shoulder



Contour



Coolant

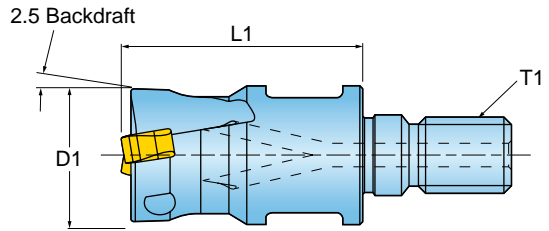

Cutter Number	D1 Nominal Diameter	Insert	L1 Extension	T1 Thread Size	No. of Inserts	Wrench Size
15V1D-07012X6R02	0.750	CNHU06	1.25	M10	3	15mm
15V1G-10012X7R01	1.000	CNHU11	1.25	M12	2	17mm
15V1D-10012X7R01	1.000	CNHU06	1.25	M12	3	17mm
15V1G-12015X8R01	1.250	CNHU11	1.50	M16	3	22mm
15V1D-12015X8R01	1.250	CNHU11	1.50	M16	4	22mm

For Top-On shanks and adaptors, see [pages 730-737](#).
Operating guidelines on [page 371](#).

INSERTS

CNHU060310N

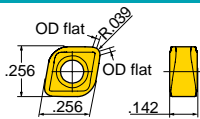

CNHU110420N

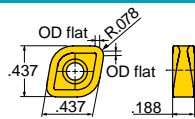

Part Number	Applications	Grade										
			IN1030	IN2005	IN2006	IN2040	IN3005					
CNHU060310N	Finish./Semi-Finish. - 1.000 mm R w/1mm OD flat		●	●	●	●	●					
CNHU110420N	Finish./Semi-Finish. - 2.000 mm R w/2mm OD flat		●	●	●	●	●					

● = P ● = M ● = K ● = N ● = S ○ = H

HARDWARE



Screw



Driver

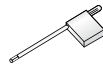

Driver

15V1D-07012X6R02	SM25-075-20	-	DS-T08W
15V1D-10012X7R01	SM25-075-20	-	DS-T08W
15V1G-10012X7R01	SM35-088-10	DS-T10T	-
15V1D-12015X8R01	SM25-075-20	-	DS-T08W
15V1G-12015X8R01	SM35-088-10	DS-T10T	-



BACK DRAFT FINISH SHELL MILL WITH 4 INDEXES

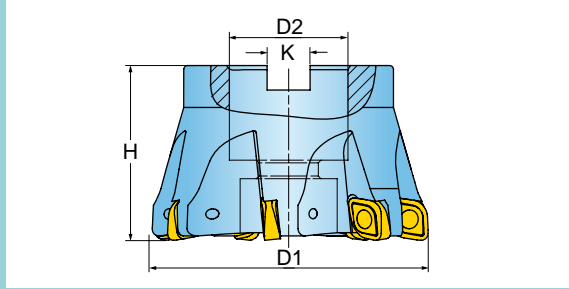

Cutter Number	D1 Nominal Diameter	H Height	D2 Bore Diameter	K Keyway	Effective Flutes	Coolant	Drive
5V6G-20R01	2.000	1.570	0.750	0.312	5	No	.312 Radial Keyway
5V6G-20R02	2.000	2.000	1.250	NA	5	No	Hi-Tork Style ^{™*}

*Hi-Tork is a trademark of Precision Components
Operating guidelines on [page 371](#).

INSERTS





CNHU110420N





Part Number	Applications	Grade	IN1030	IN2005	IN2006	IN2040				
-------------	--------------	-------	--------	--------	--------	--------	--	--	--	--

CNHU110420N	Finish./Semi-Finish. - 2.000 mm R w/2mm OD flat									
--------------------	---	--	--	--	--	--	--	--	--	--

HARDWARE

				
	Screw	Driver	Retention Bolt	Set Screw
5V6G-20R01	SM35-088-10	DS-T10T	SD-06-46	-
5V6G-20R02	SM35-088-10	DS-T10T	-	SA-06-37

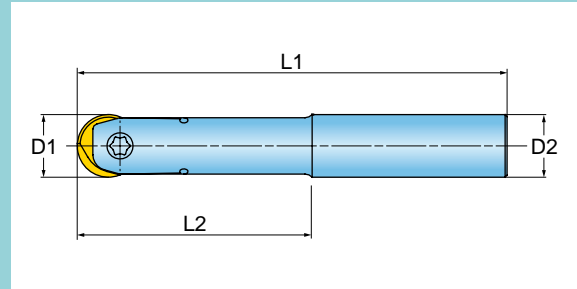
FINISH BALL NOSE END MILL



Cutter Number	D1 Effective Diameter	D2 Shank Size/Style	L2 Extension	L1 Overall Length	Effective Cutting Edges	Insert Series
12W9F-03017S4R01	0.375	.500" Cylindrical	1.85	6.00	2	09
12W9H-05019S4R01	0.500	.500" Cylindrical	1.92	7.00	2	12
12W9K-06015S6R01	0.625	.625" Cylindrical	1.58	8.00	2	15
12W9M-07018S7R01	0.750	.750" Cylindrical	1.85	8.00	2	19
12W9R-10018S1R01	1.000	1.000" Cylindrical	1.81	8.00	2	25
12W9S-12030S9R01	1.250	1.000" Cylindrical	3.03	11.81	2	31

Operating guidelines on [page 370](#).

Part Number	Applications	Grade							
			IN05S	IN2005	IN2006				
GPHG091208R01	Finish./Semi-Finish. - 0.031" R			●					
GPHG121708R01	Finish./Semi-Finish. - 0.031" R			●					
GPHG121716R01	Finish./Semi-Finish. - 0.062" R			●					
GPHG121732R01	Finish./Semi-Finish. - 0.125" R			●					
GPHG152208R01	Finish./Semi-Finish. - 0.031" R			●					
GPHG152216R01	Finish./Semi-Finish. - 0.062" R			●					
GPHG152232R01	Finish./Semi-Finish. - 0.125" R			●					
GPHG192508R01	Finish./Semi-Finish. - 0.031" R			●					
GPHG192516R01	Finish./Semi-Finish. - 0.062" R			●					
GPHG192532R01	Finish./Semi-Finish. - 0.125" R			●					
GPHG252608R01	Finish./Semi-Finish. - 0.031" R			●					
GPHG252616R01	Finish./Semi-Finish. - 0.062" R			●					
GPHG252632R01	Finish./Semi-Finish. - 0.125" R			●					
NPHG090300R	Finish./Semi-Finish. - 0.187" R			●	●				
NPHG120400R	Finish./Semi-Finish. - 0.250" R	●		●	●				
NPHG150400R	Finish./Semi-Finish. - 0.312" R			●	●				
NPHG190400R	Finish./Semi-Finish. - 0.375" R	●		●	●				
NPHG250600R	Finish./Semi-Finish. - 0.500" R	●		●	●				
NPHG310700R	Finish./Semi-Finish. - 0.625" R			●					

● = P ● = M ● = K ● = N ● = S ○ = H

INSERTS

GPHG091208R01		GPHG121708R01		GPHG121716R01	
GPHG121732R01		GPHG152208R01		GPHG152216R01	
GPHG152232R01		GPHG192508R01		GPHG192516R01	
GPHG192532R01		GPHG252608R01		GPHG252616R01	
GPHG252632R01		NPHG090300R		NPHG120400R	
NPHG150400R		NPHG190400R		NPHG250600R	
NPHG310700R					

HARDWARE



	Insert Screw	Driver	Allen Wrench
12W9F-03017S4R01	SM30-082-B0	TD10P	-
12W9H-05019S4R01	SM40-106-B0	TD15P	-
12W9K-06015S6R01	SM50-138-B0	-	L-W3
12W9M-07018S7R01	SM60-165-B0	-	L-W4
12W9R-10018S1R01	SM70-210-B0	-	L-W4
12W9S-12030S9R01	SM80-250-B0	-	L-W4

FINISH BALL™ SERIES 12W9 (TOP-ON STYLE)

FINISH BALL NOSE MODULAR ND MILL



Ramping



Corkscrew



Pocket



Contour

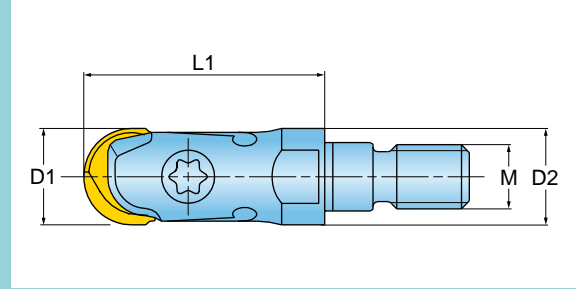

Cutter Number	D1 Effective Diameter	M Adaption	D2 Flange Diameter	L1 Ext. From Holder	Effective Cutting Edges	Insert Series	Wrench Size
12W9F-03011X5R01	0.375	M8	0.51	1.18	2	09	10mm
12W9H-05011X5R01	0.500	M8	0.51	1.18	2	12	10mm
12W9K-06015X5R01	0.625	M8	0.51	1.50	2	15	10mm
12W9K-06017X6R01	0.625	M10	0.71	1.77	2	15	15mm
12W9M-07016X6R01	0.750	M10	0.71	1.69	2	19	15mm
12W9M-07021X7R01	0.750	M12	0.83	2.17	2	19	17mm
12W9R-10023X7R01	1.000	M12	0.89	2.36	2	25	17mm
12W9R-10023X8R01	1.000	M12	1.14	2.36	2	25	17mm

For Top-On shanks and adaptors, see [pages 730-737](#).
Operating guidelines on [page 370](#).

HARDWARE



Insert Screw



Driver



Allen Wrench

Cutter Number	Insert Screw	Driver	Allen Wrench
12W9F-03011X5R01	SM30-082-B0	TD-10P	-
12W9H-05011X5R01	SM40-106-B0	TD-15P	-
12W9K-06015X5R01	SM50-138-B0	-	L-W3
12W9K-06017X6R01	SM50-138-B0	-	L-W3
12W9M-07016X6R01	SM60-165-B0	-	L-W4
12W9M-07021X7R01	SM60-165-B0	-	L-W4
12W9R-10023X7R01	SM70-210-B0	-	L-W4
12W9R-10023X8R01	SM70-210-B0	-	L-W4

INSERTS



Part Number	Applications	Grade						
		IN05S	IN2005	IN2006				
GPHG091208R01	Finish./Semi-Finish. - 0.031" R		●					
GPHG121708R01	Finish./Semi-Finish. - 0.031" R		●					
GPHG121716R01	Finish./Semi-Finish. - 0.062" R		●					
GPHG121732R01	Finish./Semi-Finish. - 0.125" R		●					
GPHG152208R01	Finish./Semi-Finish. - 0.031" R		●					
GPHG152216R01	Finish./Semi-Finish. - 0.062" R		●					
GPHG152232R01	Finish./Semi-Finish. - 0.125" R		●					
GPHG192508R01	Finish./Semi-Finish. - 0.031" R		●					
GPHG192516R01	Finish./Semi-Finish. - 0.062" R		●					
GPHG192532R01	Finish./Semi-Finish. - 0.125" R		●					
GPHG252608R01	Finish./Semi-Finish. - 0.031" R		●					
GPHG252616R01	Finish./Semi-Finish. - 0.062" R		●					
GPHG252632R01	Finish./Semi-Finish. - 0.125" R		●					
NPHG090300R	Finish./Semi-Finish. - 0.187" R		●	●				
NPHG120400R	Finish./Semi-Finish. - 0.250" R	●	●	●				
NPHG150400R	Finish./Semi-Finish. - 0.312" R		●	●				
NPHG190400R	Finish./Semi-Finish. - 0.375" R	●	●	●				
NPHG250600R	Finish./Semi-Finish. - 0.500" R	●	●	●				

● = P ● = M ● = K ● = N ● = S ○ = H

FINISH BALL™ SERIES 12W5 (SOLID CARBIDE)

FINISH BALL NOSE END MILL - CARBIDE

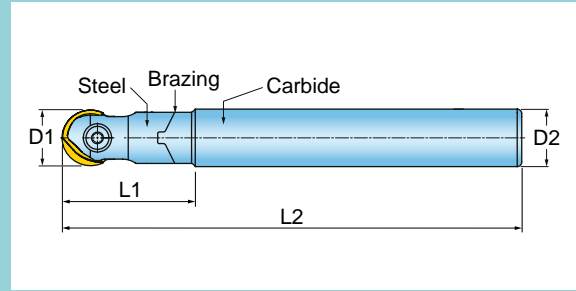

Cutter Number	D1 Effective Diameter	D2 Shank Size/Style	L1 Extension Length	L2 Overall Length	Effective Cutting Edges	Insert Series
12W5F-03015R8R01	0.375	.375" Cylindrical	1.50	6.00	2	09
12W5F-03015R8R02	0.375	.375" Cylindrical	1.50	4.00	2	09
12W5H-05015S4R01	0.500	.500" Cylindrical	1.50	7.00	2	12
12W5H-05015S4R02	0.500	.500" Cylindrical	1.50	4.00	2	12
12W5K-06018S6R01	0.625	.625" Cylindrical	1.88	7.00	2	15
12W5K-06018S6R02	0.625	.625" Cylindrical	1.88	4.00	2	15
12W5M-07022S7R01	0.750	.750" Cylindrical	2.25	7.50	2	19
12W5M-07022S7R02	0.750	.750" Cylindrical	2.25	4.50	2	19

Operating guidelines on [page 370](#).

Cutter Number	HARDWARE		
	Insert Screw	Driver	Allen Wrench
12W5F-03015R8R01	SM30-082-B0	TD-10P	-
12W5F-03015R8R02	SM30-082-B0	TD-10P	-
12W5H-05015S4R01	SM40-106-B0	TD-15P	-
12W5H-05015S4R02	SM40-106-B0	TD-15P	-
12W5K-06018S6R01	SM50-138-B0	-	L-W3
12W5K-06018S6R02	SM50-138-B0	-	L-W3
12W5M-07022S7R01	SM60-165-B0	-	L-W4
12W5M-07022S7R02	SM60-165-B0	-	L-W4

INSERTS

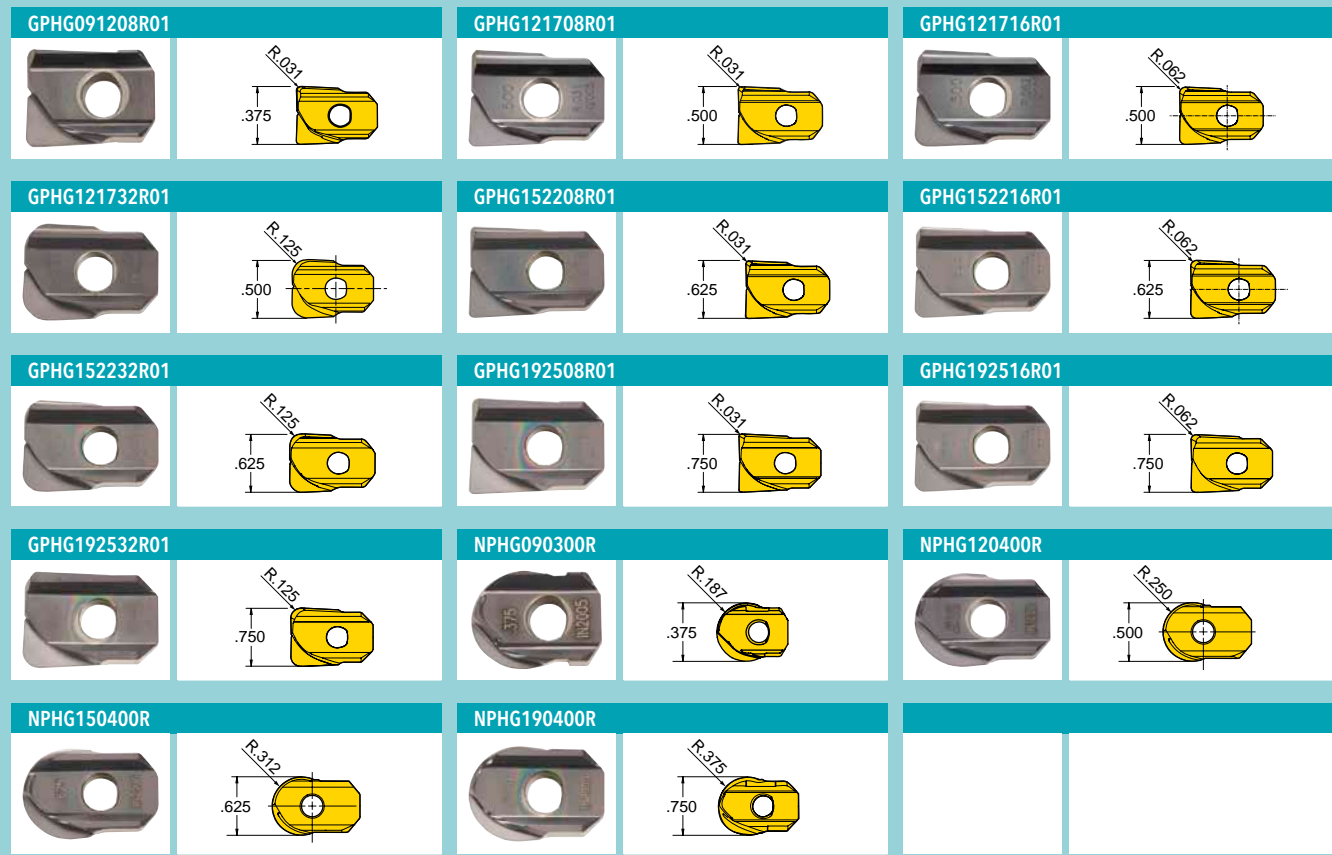

Part Number	Applications	Grade								
			IN05S	IN2005	IN2006					
GPHG091208R01	Finish./Semi-Finish. - 0.031" R			●						
GPHG121708R01	Finish./Semi-Finish. - 0.031" R			●						
GPHG121716R01	Finish./Semi-Finish. - 0.062" R			●						
GPHG121732R01	Finish./Semi-Finish. - 0.125" R			●						
GPHG152208R01	Finish./Semi-Finish. - 0.031" R			●						
GPHG152216R01	Finish./Semi-Finish. - 0.062" R			●						
GPHG152232R01	Finish./Semi-Finish. - 0.125" R			●						
GPHG192508R01	Finish./Semi-Finish. - 0.031" R			●						
GPHG192516R01	Finish./Semi-Finish. - 0.062" R			●						
GPHG192532R01	Finish./Semi-Finish. - 0.125" R			●						
NPHG090300R	Finish./Semi-Finish. - 0.187" R			●		●				
NPHG120400R	Finish./Semi-Finish. - 0.250" R		●	●		●				
NPHG150400R	Finish./Semi-Finish. - 0.312" R			●		●				
NPHG190400R	Finish./Semi-Finish. - 0.375" R		●	●		●				

● = P ● = M ● = K ● = N ● = S ○ = H

BALL NOSE END MILL, 2 EFFECTIVE

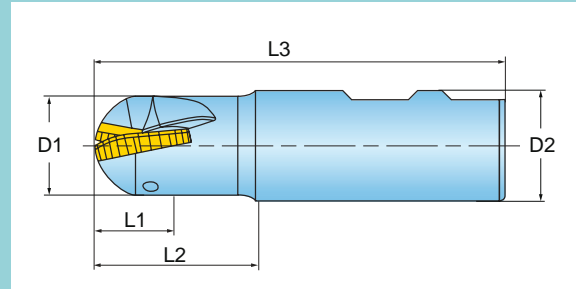

Cutter Number	D1 Nom. Dia.	L1 Max. Depth of Cut	L2 Extension Length	L3 Overall Length	D2 Shank Size/Style	No. of Effective Flutes	Insert Series
1BW7T-0501778R01	0.500	0.25	1.72	3.50	.500" Weldon	2	(2)NKET12
1BW8T-0504584R01	0.500	0.25	4.50	6.50	.750" Weldon	2	(2)NKET12
1BW7V-0701584R01	0.750	0.38	1.50	3.50	.750" Weldon	2	(2)NKET18
1BW7V-0704084R01	0.750	0.38	2.25	6.00	.750" Weldon	2	(2)NKET18
1BW8V-0705780R01	0.750	0.38	5.75	8.00	1.000" Weldon	2	(2)NKET18
1BW7W-1001580R01	1.000	0.50	1.50	3.75	1.000" Weldon	2	(2)NCET25
1BW7W-10037E1R01	1.000	0.50	3.75	6.75	1.000" Weldon	2	(2)NCET25
1BW7X-1202781R01	1.250	0.63	2.75	5.00	1.250" Weldon w/Flange	2	(2)NNET31
1BW7X-1205081R01	1.250	0.63	5.00	7.25	1.250" Weldon w/Flange	2	(2)NNET31
1BW7X-1205781R01	1.250	0.63	5.75	8.00	1.250" Weldon w/Flange	2	(2)NNET31
2BW3Z-1504581R01	1.500	0.75	4.50	6.75	1.250" Weldon w/Flange	2	(2)NDET38, (4)DGM314
2BW3Z-1506086R01	1.500	0.75	6.00	8.66	1.500" Weldon w/Flange	2	(2)NDET38, (4)DGM314
2BW3Y-20040E4R01	2.000	2.70	4.00	8.00	2.000" Weldon	2	(2)NDET50, (4)DGM324
2BW3Y-20070E4R01	2.000	2.70	7.00	11.00	2.000" Weldon	2	(2)NDET50, (4)DGM324

Operating guidelines on [page 379](#).





INSERTS



Part Number	Applications	Grade								
			IN2005	IN2015	IN2030	IN2040	IN6515			
DGM314R001	Multi-Purpose - 0.031" R		●	●	●	●	●			
DGM324R001	Multi-Purpose - 0.031" R		●	●	●	●	●			
NKET120200R	Multi-Purpose - 0.250" R		●		●					
NKET180300R	Multi-Purpose - 0.375" R		●							
NCET250400R	Multi-Purpose - 0.500" R		●		●					
NNET310500R	Multi-Purpose - 0.625" R		●							
NDET380700R	MultiPurpose - Chip Breaker - 0.750" R		●							
NDET500800R	MultiPurpose - Chip Breaker - 1.000" R		●							

● = P ● = M ● = K ● = N ● = S ○ = H

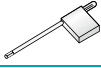
HARDWARE

					
	DGM Screw	Ball Insert Screw	Ball Insert Driver	Ball Insert Driver	DGM Insert Driver
1BW7T-0501778R01	-	SM25-052-80	DS-T06F	-	-
1BW8T-0504584R01	-	SM25-052-80	DS-T06F	-	-
1BW7V-0701584R01	-	SM30-080-10	DS-T09W	-	-
1BW7V-0704084R01	-	SM30-080-10	DS-T09W	-	-
1BW8V-0705780R01	-	SM30-080-10	DS-T09W	-	-
1BW7W-1001580R01	-	SM35-110-00	-	DS-T15T	-
1BW7W-10037E1R01	-	SM35-110-00	-	DS-T15T	-
1BW7X-1202781R01	-	SM40-120-20	-	DS-T15T	-
1BW7X-1205081R01	-	SM40-120-20	-	DS-T15T	-
1BW7X-1205781R01	-	SM40-120-20	-	DS-T15T	-
2BW3Z-1504581R01	SM35-110-00	SM50-160-10	-	DS-T15T	DS-T20T
2BW3Z-1506086R01	SM35-110-00	SM50-160-10	-	DS-T15T	DS-T20T
2BW3Y-20040E4R01	SM40-140-00	SM60-180-00	-	DS-T15T	DS-T25T
2BW3Y-20070E4R01	SM40-140-00	SM60-180-00	-	DS-T15T	DS-T25T

PROBALL™ SERIES 1BW (TOP-ON STYLE)

MODULAR BALL NOSE END MILL

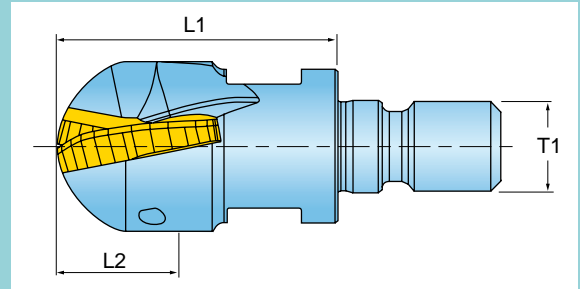

Cutter Number	D1 Nom. Dia.	L1 Extension Length	L2 Max. Depth of Cut	T1 Shank Size/Style	Number of Effective Flutes	Accepts Inserts	Coolant Through	Wrench Size
1BW7T-05010X5R01	0.500	1.00	0.25	M8	2	NKET12	No	10mm
1BW7V-07015X6R01	0.750	1.50	0.38	M10	2	NKET18	Yes	15mm
1BW7W-10015X7R01	1.000	1.50	0.50	M12	2	NCET25	Yes	17mm

For Top-On shanks and adaptors, see [pages 730-737](#).
Operating guidelines on [page 379](#).

INSERTS

NKET120200R

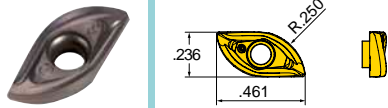

NKET180300R

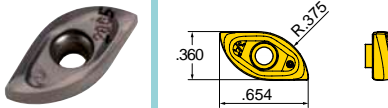

NCET250400R

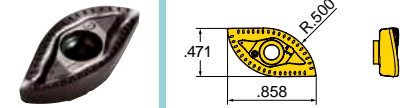

Part Number	Applications	Grade										
			IN2005	IN2030								
NKET120200R	Multi-Purpose - 0.250" R		●	●								
NKET180300R	Multi-Purpose - 0.375" R		●	●								
NCET250400R	Multi-Purpose - 0.500" R		●	●								

● = P ● = M ● = K ● = N ● = S ○ = H

HARDWARE

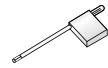

Screw

Driver

Driver

1BW7T-05010X5R01	SM25-052-80	DS-T06F	-
1BW7V-07015X6R01	SM30-080-10	DS-T09W	-
1BW7W-10015X7R01	SM35-110-00	-	DS-T15T

PROBALL™ SERIES 1BW (CHIP-SURFER STYLE)

MODULAR BALL NOSE END MILL

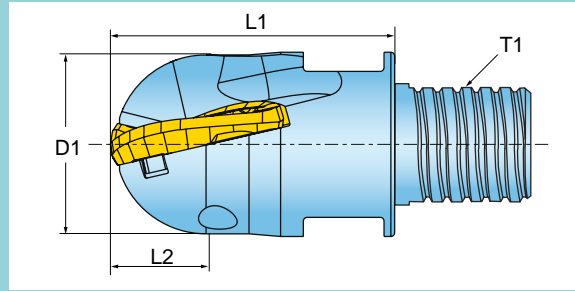

Cutter Number	D1 Nom. Dia.	L1 Extension Length	L2 Max. Depth of Cut	T1 Shank Size/Style	Number of Effective Flutes	Accepts Inserts
1BW7T-05007T8R01	0.500	0.75	0.25	T08	2	NKET12
1BW7V-07010TSR01	0.750	1.00	0.38	T12	2	NKET18

For Chip Surfer shank selection, see [page 422](#).
Operating guidelines on [page 379](#).

INSERTS

NKET120200R

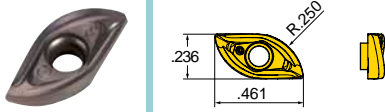

NKET180300R

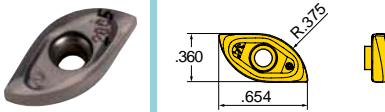

Part Number	Applications	Grade							
		IN2005	IN2030						
NKET120200R	Multi-Purpose - 0.250" R								
NKET180300R	Multi-Purpose - 0.375" R								

● = P ● = M ● = K ● = N ● = S ○ = H

HARDWARE



Screw

Driver

Wrench

Optional Torque Wrench

1BW7T-05007T8R01	SM25-052-80	DS-T06F	WS-0030	DT-130-10
1BW7V-07010TSR01	SM30-080-10	DS-T09W	WS-0059	DT-250-16

PROBALL™ SERIES 1BW (HI-TORK STYLE)

BALL NOSE END MILL

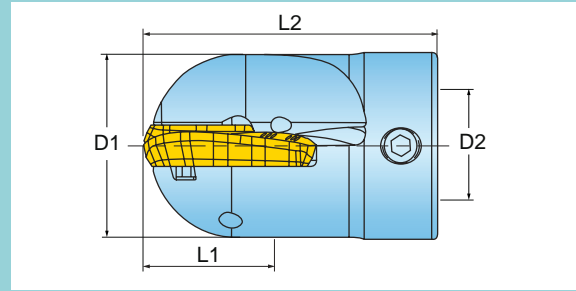

Cutter Number	D1 Nom. Dia.	L1 Max. Depth of Cut	L2 Overall Length	D2 Shank Size/Style	Number of Effective Flutes
1BW7Y-2003076R01	2.000	1.70	3.00	1.25" Hi-Tork™*	2

*Hi-Tork is a trademark of Precision Components
Operating guidelines on [page 379](#).

INSERTS

NDET500800R					

Part Number	Applications	Grade							
NDET500800R	MultiPurpose - Chip Breaker - 1.000" R	IN2005							

● = P ● = M ● = K ● = N ● = S ○ = H

HARDWARE			
Screw	Driver	Set Screw	

SM60-180-00	DS-T25T	SA-06-37	
-------------	---------	----------	--

PUNCH-INQUAD™ SERIES DHU (TOP-ON STYLE)

MODULAR PLUNGING CUTTERS

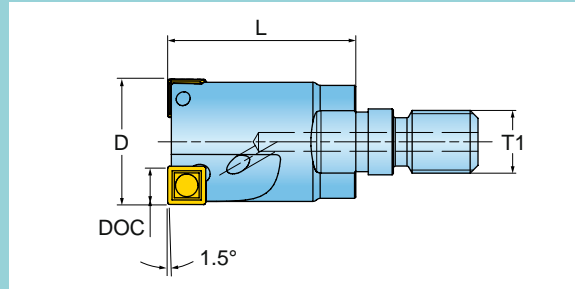

Cutter Number	D Effective Diameter	Number of Inserts	T1 Thread Size	L Length	DOC Max. Radial Depth of Cut	Wrench Size	Insert Series
DHU-07512X6R10	0.750	2	M10	1.250	0.28	15mm	SPLT07
DHU-10012X7R01	1.000	2	M12	1.250	0.34	17mm	SHLT09
DHU-10012X7R10	1.000	3	M12	1.250	0.28	17mm	SPLT07
DHU-12015X8R01	1.250	3	M16	1.500	0.34	22mm	SHLT09
DHU-12015X8R02	1.250	2	M16	1.500	0.40	22mm	SHLT11
DHU-15017X8R02	1.500	3	M16	1.750	0.40	22mm	SHLT11

For Top-On shanks and adaptors, see [pages 730-737](#).

Operating guidelines on [page 377](#).

INSERTS

SHLT090408N-FS		SHLT090416N-FS		SHLT110408N-FS	
SHLT110408TN-HR		SHLT110416N-FS		SPLT07T308N-PH	

Part Number	Applications	Grade	Applications									
			IN1030	IN1530	IN2005	IN30M	IN40P	IN6515	IN6520	IN6530		
SHLT090408N-FS	Heavy-Duty - 0.031" R		●		●					●		
SHLT090416N-FS	Heavy-Duty - 0.062" R			●								
SHLT110408N-FS	Heavy-Duty - 0.031" R		●		●					●		
SHLT110408TN-HR	Multi-Purpose - 0.031" R		●		●	●	●					●
SHLT110416N-FS	Heavy-Duty - 0.062" R		●									
SPLT07T308N-PH	Multi-Purpose - 0.030" R		●		●						●	

● = P ● = M ● = K ● = N ● = S ○ = H

HARDWARE

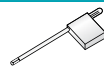

Screw

Driver

Driver

DHU-07512X6R10	SM25-064-00	-	DS-T08W
DHU-10012X7R01	SM40-080-30	DS-T15T	-
DHU-10012X7R10	SM25-064-00	-	DS-T08W
DHU-12015X8R01	SM40-080-30	DS-T15T	-
DHU-12015X8R02	SM40-120-20	DS-T15T	-
DHU-15017X8R02	SM40-120-20	DS-T15T	-

PLUNGING CUTTERS

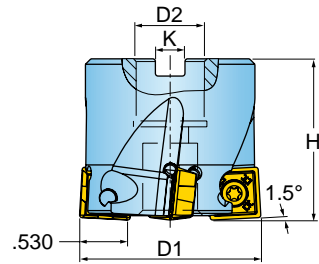

Cutter Number	D1 Effective Diameter	Number of Inserts	D2 Bore Dia.	K Keyway	H Height
DHU-20017D1R01	2.000	4	0.750	0.312	1.750
DHU-25017D1R01	2.500	5	0.750	0.312	1.750
DHU-30017D3R01	3.000	6	1.000	0.375	1.750
DHU-40020D4R01	4.000	8	1.250	0.500	2.000

Operating guidelines on [page 377](#).

INSERTS

SHLT140508N-FS

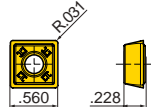

SHLT140508TN-HR

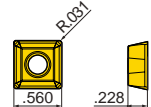
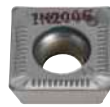

SHLT140516N-FS

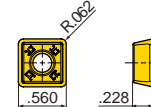

SHLT140516TN-HR

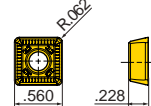

SHLT140532N-FS

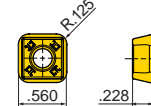

Part Number	Applications	Grade								
			IN1030	IN1530	IN2005	IN30M	IN40P	IN6515	IN6530	
SHLT140508N-FS	Heavy-Duty - 0.031" R		●		●			●		
SHLT140508TN-HR	Multi-Purpose - 0.031" R		●		●	●	●		●	
SHLT140516N-FS	Heavy-Duty - 0.062" R		●		●			●		
SHLT140516TN-HR	Multi-Purpose - 0.062" R			●	●					
SHLT140532N-FS	Heavy-Duty - 0.125" R				●					

● = P ● = M ● = K ● = N ● = S ○ = H

HARDWARE



DHU-20017D1R01	SM50-127-10	DS-T20T	SD-06-47	SD-06-89
DHU-25017D1R01	SM50-127-10	DS-T20T	SD-06-47	SD-06-89
DHU-30017D3R01	SM50-127-10	DS-T20T	SD-08-47	SD-08-92
DHU-40020D4R01	SM50-127-10	DS-T20T	SD-10-47	SD-10-99

PLUNGING CUTTER WITH 4 INDEXES

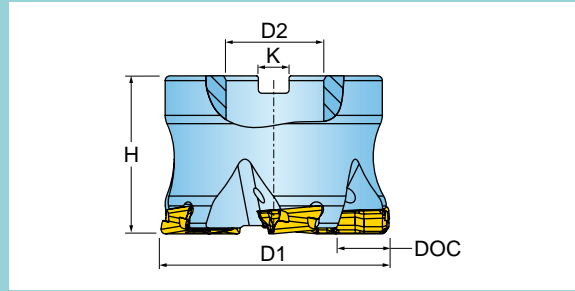

Cutter Number	D1 Nominal Diameter	Number of Inserts	D2 Bore Dia.	K Keyway	H Height	Insert Series	DOC
SHU-20015D1R01	2.000	4	0.750	0.312	1.570	DPM324	0.375
SHU-25015D1R01	2.500	5	0.750	0.312	1.570	DPM324	0.375
SHU-30020D3R01	3.000	5	1.000	0.375	2.000	DPM434	0.590
SHU-40022D5R01	4.000	7	1.500	0.625	2.250	DPM434	0.590

Operating guidelines on [page 377](#).

INSERTS

DPM324L050

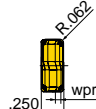
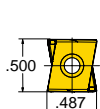

DPM434L050

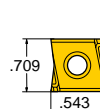

Part Number	Applications	Grade							
		IN20050	IN2530						
DPM324L050	Multi-Purpose - 0.062" R								
DPM434L050	Multi-Purpose - 0.062" R								

● = P ● = M ● = K ● = N ● = S ○ = H

HARDWARE



Screw



Driver



Retention Bolt



(Optional) Coolant Bolt

SHU-20015D1R01	SM40-120-20	DS-T15T	SD-06-46	SD-06-89
SHU-25015D1R01	SM40-120-20	DS-T15T	SD-06-46	SD-06-89
SHU-30020D3R01	SM50-160-10	DS-T20T	SD-08-47	SD-08-92
SHU-40022D5R01	SM50-160-10	DS-T20T	SD-12-82	SD-12-99

PLUNGING CUTTER WITH UP TO 8 INDEXES (4RH-4LH)

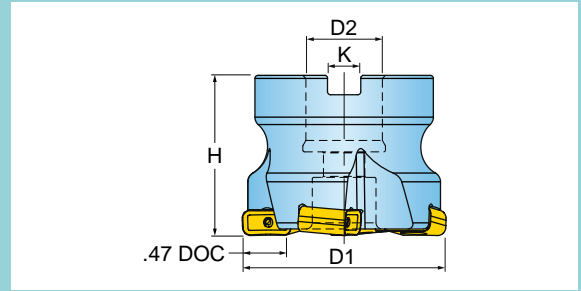

Cutter Number	Rotation	D1 Nominal Diameter	No. of Inserts	D2 Bore Dia.	K Keyway	H Height
VHU-20015D1L01	Left	2.000	4	0.750	0.312	1.570
VHU-20015D1R01	Right	2.000	4	0.750	0.312	1.570
VHU-25015D1L01	Left	2.500	5	0.750	0.312	1.570
VHU-25015D1R01	Right	2.500	5	0.750	0.312	1.570
VHU-30020D3L01	Left	3.000	5	1.000	0.375	2.000
VHU-30020D3R01	Right	3.000	5	1.000	0.375	2.000
VHU-4001958L01	Left	4.000	7	1.500	0.625	1.970
VHU-4001958R01	Right	4.000	7	1.500	0.625	1.970
VHU-5001958L01	Left	5.000	9	1.500	0.625	1.970
VHU-5001958R01	Right	5.000	9	1.500	0.625	1.970
VHU-6001958L01	Left	6.000	11	1.500	0.625	1.970
VHU-6001958R01	Right	6.000	11	1.500	0.625	1.970

Operating guidelines on [page 376](#).

INSERTS

NNE324-100

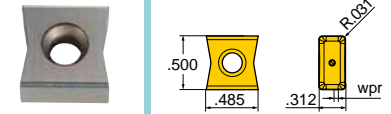

NNE324-102

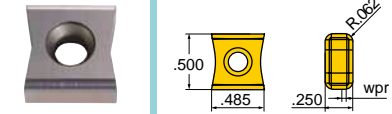

NNE324-125

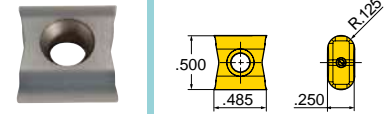

Part Number	Applications	Grade	IN2010	IN2015	IN2030	IN2040	IN2530	IN6515			
NNE324-100	Multi-Purpose - 0.031" R		●	●	●	●	●	●			
NNE324-102	Multi-Purpose - 0.062" R			●	●	●	●	●			
NNE324-125	Multi-Purpose - 0.125" R		●		●						

● = P
 ● = M
 ● = K
 ● = N
 ● = S
 ○ = H

HARDWARE



	Screw	Driver	Retention Bolt
VHU-20015D1L01	SM40-120-20	DS-T15T	SD-06-46
VHU-20015D1R01	SM40-120-20	DS-T15T	SD-06-46
VHU-25015D1L01	SM40-120-20	DS-T15T	SD-06-46
VHU-25015D1R01	SM40-120-20	DS-T15T	SD-06-46
VHU-30020D3L01	SM40-120-20	DS-T15T	SD-08-47
VHU-30020D3R01	SM40-120-20	DS-T15T	SD-08-47
VHU-4001958L01	SM40-120-20	DS-T15T	-
VHU-4001958R01	SM40-120-20	DS-T15T	-
VHU-5001958L01	SM40-120-20	DS-T15T	-
VHU-5001958R01	SM40-120-20	DS-T15T	-
VHU-6001958L01	SM40-120-20	DS-T15T	-
VHU-6001958R01	SM40-120-20	DS-T15T	-

Ingersoll



- **MILLING APPLICATION & SELECTION**
PAGE 304
- **GENERAL APPLICATION INFORMATION & GLOSSARY**
PAGE 306
- **BETTER SURFACE FINISHES**
PAGE 308
- **RIGIDITY ANALYSIS**
PAGE 310
- **RADIAL CHIP THINNING**
PAGE 312
- **BALL NOSE MILLING APPLICATION**
PAGE 314
- **HIFEED CUTTER OPERATING GUIDELINES**
PAGE 318
- **FASTBREAK O.D. CORNER ROUNDS APPLICATION CHART**
PAGE 319
- **TROUBLESHOOTING CHART**
PAGE 320
- **HELPFUL FORMULI / SYMBOLS DEFINED**
PAGE 321

TECHNICAL INFORMATION.

Cutting Tools

- **MILLING GRADES, INSERTS, SCREW & DRIVERS**

PAGE 322

- **GENERAL OPERATING GUIDELINES**

PAGE 344

- **INDEX**

PAGE 344

- **GENERAL OPERATING GUIDELINES**

PAGE 345

- **END MILLS**

PAGE 346

- **FACE MILLS**

PAGE 358

- **CONTOUR MILLING**

PAGE 370

- **SLOTTERS**

PAGE 380

MILLING APPLICATION & SELECTION

GOING BACK TO THE BASICS OF FACE MILL DESIGN TO SELECT A TOOL TO MATCH YOUR APPLICATION

When milling with an indexable face mill, the workpiece, machine, and fixturing must all be as rigid as possible. This will help ensure efficient use of this type of tool and produce the results required. Only cutters using indexable carbide inserts will be discussed here.

Proper cutter diameter. For maximum efficiency, two-thirds of the cutter diameter should engage the workpiece. In other words, the cutter diameter should be 1-1/2 times the width of cut desired.

Climb milling using this cutter diameter to width of cut ratio will ensure a favorable entry angle into the workpiece (Fig. 1).

If uncertain as to whether the machine has enough horsepower to operate the cutter under this ratio, it may be best to divide the axial depth of cut into two passes (or more) to maintain as closely as possible this cutter diameter to width of cut ratio.

Fig. 1

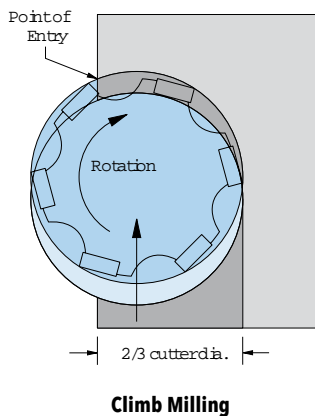
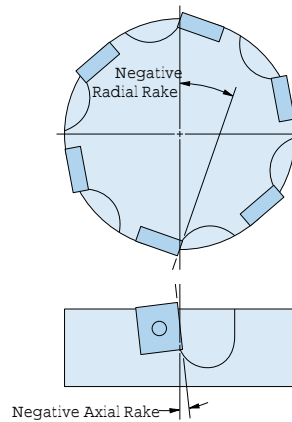
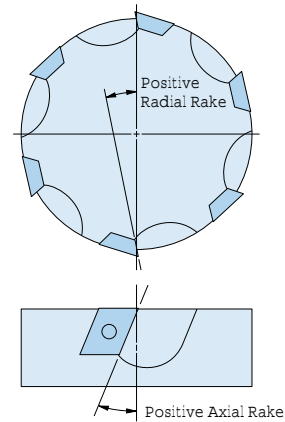

Fig. 2



Negative Geometry

Fig. 3



Positive Geometry

Applying cutter geometry. Insert cutting edges may be positioned relative to both radial and axial planes in positive, neutral, or negative rakes. Neutral rake is generally not used due to the shock of the entire cutting edge impacting the workpiece simultaneously.

The combination of radial and axial rakes determines the shear angle. Three basic combinations are available: negative radial and axial, positive radial and axial, negative radial/positive axial, and positive radial/negative axial.

Double negative geometry is the traditional starting point for rough milling cast iron and steels when horsepower and rigidity are adequate. The double negative insert design provides the strongest possible cutting edge and can withstand heavier chip loads and considerable cutting forces (Fig. 2).

The increased cutting forces generated by this geometry will consume more horsepower. Double negative cutters also require greater machine, workpiece, and fixture rigidity.

Double positive geometry provides the most efficient cutting action due to its increased shearing angle. Although not as strong as double negative, entry impact and cutting forces are greatly reduced, making it a good choice for older, less rigid machines or where horsepower is limited.

With double positive geometry, the peripheral edge, in both the radial and axial planes, leads the insert through the workpiece creating a true shearing action. This makes it the best choice for non-ferrous materials and many soft, gummy stainless steels (Fig. 3).

Negative radial/positive axial geometry combines some of the advantages of both double negative and double positive. Negative radial rake provides strong cutting edges, while positive axial rake creates a shearing action. A positive axial rake directs chips up and away from the workpiece. This prevents chip recutting and takes heat away from the work surface and the cutting edge.

Positive radial/negative axial geometry reduces power consumption while still providing a strong corner cross-section.

MILLING APPLICATION & SELECTION

Effective lead angles. Cutter lead angles also affect performance. A 45° lead tool reduces chip thickness about 30 percent as compared to a 0° lead tool (Fig. 4). This allows you to maintain a given chip load at a higher feed rate, increasing the metal removal rate.

A proper lead angle allows a cutter to enter and exit the cut more smoothly, minimizing shock to the cutting edges. Workpiece edge breakout, a common problem when machining cast iron, can be significantly reduced or eliminated by use of increased lead angle. The lead angle allows the cutting edge to exit the workpiece gradually. This reduces radial pressure and minimizes breakout.

Remember that increasing the lead angle to reduce radial pressure does increase axial pressure. This can cause deflection of the machined surface when the workpiece has a thin cross-section.

Choosing cutter density. The cutter density must allow chips to form properly and clear the cut. Inadequate chip space can cause chips to plug the gullet, breaking the cutting edge and possibly damaging the workpiece.

Fig. 4

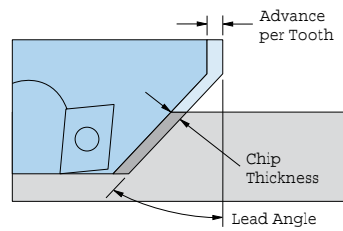

Lead Angles

However, the cutter must have sufficient density to keep at least one insert in the cut at all times. Failure to do this could cause severe pounding which can lead to chipped cutting edges, a damaged cutter, and excess wear to the machine (Fig. 5).

Coarse pitch tools, with 1 to 1-1/2 inserts per inch of diameter, allow for greater chip gullet space. These tools are recommended for soft materials that produce continuous chips, and in wide cuts with a long insert engagement.

It is desirable to have at least one insert in contact with the workpiece at all times. Fine pitch tools, though primarily for cast iron, are also good for shallow or narrow cuts in high-temperature alloys where light chip loads are taken. Small chips require less gullet, allowing more inserts per inch.

Although selecting a face mill can be a complicated and somewhat subjective process, these guidelines can give you a good starting point. By using and expanding on these principles, you will be able to select a face mill for any operation in your plant.

Fig. 5

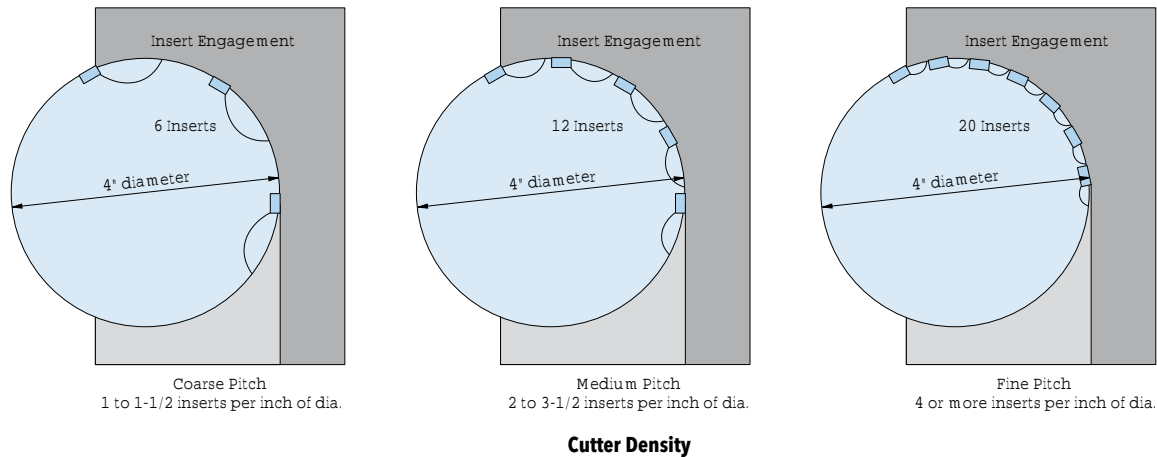

GENERAL APPLICATION INFORMATION

APPLYING BASIC PRINCIPLES OF MACHINING WITH INDEXABLES CAN IMPROVE PERFORMANCE

The following information is directed toward indexable carbide tools but it can be applied to many other cutting tools, as well. It provides some basic guidelines designed to serve as a starting point for safe and reliable performance. Contact your Ingersoll Cutting Tool Company sales engineer for specific application assistance.

Rigidity. Use the most rigid cutter possible. This usually means the cutter with the largest diameter and shortest length. Use the best adaption possible. Integral tapers, such as a 50 V-flange, are better than straight shanks. When selecting straight shank tools, use a cutter with the largest diameter shank possible and a holder with the shortest length possible. For a more complete review, see "Rigidity Analysis" on page M460.

Effective cutting edges. When calculating feed rate, use the effective number of inserts. In extended flute cutters, the effective number of inserts is not the number of rows. Use the effective number listed with the specifications for each series of tools.

Chip load. Carbide cutting tools have to take a "bite" to cut. Be sure to cut with an adequate chip load. Light chip loads can contribute to chatter, causing a cutter to "rub" instead of "bite." This can also result in poor tool life. As a general rule, chip loads should not be less than .004". Also, be sure to use Radial Chip Thinning Factors (RCTF) when calculating feed rates. Refer to "Radial Chip Thinning" located on page M462.

Chip recutting. Unlike HSS, carbide cutting tools cannot recut chips. Recutting chips will damage carbide. To evacuate chips, use air or coolant depending on the material being cut. Refer to "General Operating Guidelines" on pages M472-M509 for coolant or air chip evacuation recommendations.

Coolant. Generous amounts of coolant are required when low thermal conductivity, work hardening, and chip welding tendencies are evident.

Use coolant only when necessary. Some materials cut better dry. In some applications, coolant causes thermal cracking of inserts and poor tool life.

Refer to "General Operating Guidelines" on pages M472-M509 to find coolant requirements.

Feed rates. Reduce feed rates by 50 percent when entering or exiting a cut. Since fewer inserts are engaged in the work, pounding can occur. Reducing feed rates will reduce the shock of the interrupted cut and contribute to longer tool life.

When entering a corner during pocket milling, a larger portion of the cutter's diameter is engaged. Power requirements and tool deflection increase. To compensate, program a reduced interpolated feed rate. Alternately, drill or plunge the corner prior to milling.

Cutter rotation. Climb cut whenever possible. Carbide is designed for climb milling and will not generally perform as well when conventional cutting.

Conventional cutting may be employed on older machines to minimize backlash. It can also extend tool life in sandy, scaly, or torch-cut surfaces as the cutting edge enters into cleaner, softer material.

Hardness. generally, harder materials should be machined at the lowest speed in Surface

Fig. 1

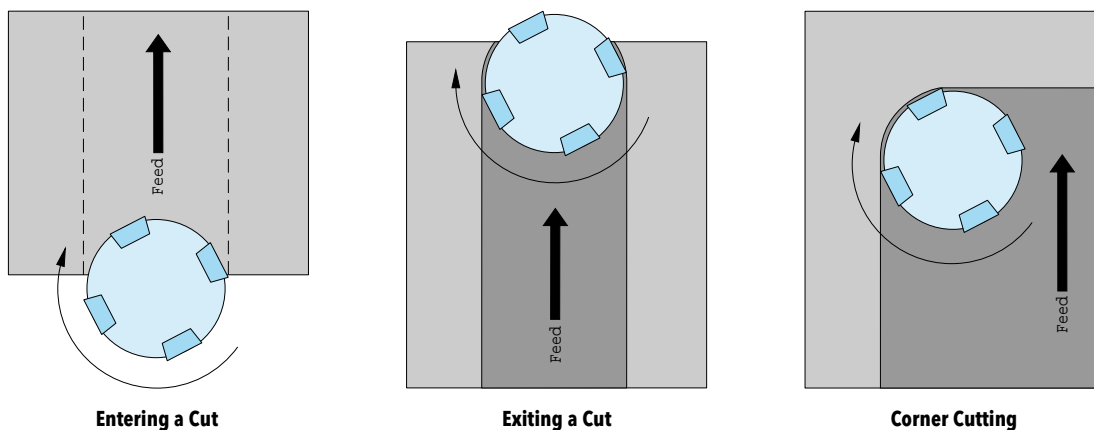

Reduce feed rates by 50% when entering a cut, exiting a cut, or entering a corner. This reduces pounding and cutting forces and can extend the life of your indexable carbide tool.

■ GENERAL APPLICATION INFORMATION

Feet per Minute (SFM) in the recommended range and softer materials at the higher recommended speed.

At 375 Brinell hardness, steel becomes very difficult to machine. Use the slowest recommended speed and the toughest carbide insert available. An edge hone may also be necessary to machine such hard material effectively.

Chip color. The color of the chips can also indicate how well your operation is performing. For example, carbon steel chips are blue. Stainless steel chips should be silver to straw colored, not blue. Titanium and nickel-based material chips should never change color.

Indexing Ingersoll inserts. Ingersoll's bent screw design used with on-edge inserts forces the insert into the corner of the pocket. The screw actually bends, locking the insert in place.

Conventional insert mounting is also common on Ingersoll products. In this case, the screw does not force the insert toward the corner of the pocket. Be sure to apply pressure into the pocket while tightening the insert screws.

Care should always be taken not to over-tighten insert screws. Over-tightened screws can become difficult to remove. Torque requirements are given for each cutter.

Indexing Ingersoll cutters is simple due to their design. However, care must be taken to make sure that the insert pocket is clean and the insert is properly seated.

After the used insert has been removed, clean the pocket. Visually inspect the cutter to see that no damage has been sustained from use. Place the insert into the pocket and start the screw. While tightening the screw, apply downward pressure on the insert toward the corner of the pocket.

A snugness will be felt on the screw as the insert seats. Do not over-tighten the insert screw. Be sure to apply the proper amount of torque listed in Ingersoll's catalogs.

If there is any doubt about the insert seating, check the seating surfaces with a .001" feeler gauge.

If the feeler gauge fits between the insert and the wall of the cutter pocket, the insert is not properly seated. Inspect the pocket for cleanliness or burrs and repeat the seating procedure. Cutters that have been damaged may have insert pockets that will no longer allow proper seating. Such tools should be replaced or returned to Ingersoll for repair.

BETTER SURFACE FINISHES

GOING BEYOND THE BASICS OF FINISH MILLING TO HELP YOU ATTAIN BETTER SURFACE FINISHES

Surface finish is the result of tool marks or irregularities left by the cutting edges of a milling cutter. These irregularities are:

Roughness: the measurement of tool marks in terms of RMS (Root Mean Square); measured with a relatively short sampling length and suppresses waviness.

Waviness: widely spaced irregularities that underlie the roughness (Fig. 1).

Flatness: the overall condition of the entire milled plane; measured by large straightedges or feelers.

Laps: blending of successive passes; normally a function of how well the milling head is squared to the table and how rigidly it is held in position.

Bearing: the supporting quality of a milled surface; a combination of all these irregularities.

How the machine affects finish. The entire machine setup must be rigid since any type of looseness or lack of rigidity will affect a milled surface finish. The "heel" or trailing edge of the cutter should clear the workpiece. Therefore, the spindle should be tilted very slightly in the direction of feed.

If the cutter is flat to the workpiece, (1) the finished surface is recut by the back side of the cutter, (2) the cutting edges can carry small chips that scratch the surface, (3) more friction creates heat build-up in the workpiece and cutting edges, and (4) increased cutter contact can induce chatter.

Too much spindle tilt creates excessive "dish" or scallops. The effect is magnified as cutter diameter increases (Fig. 2).

Cutter geometry. Axial rake has a significant effect on axial force and the thrust applied to the spindle and the workpiece. The more positive the axial rake, the less axial force. Negative axial rake increases axial force. Positive axial rake lifts the chip away from the milled surface while a negative rake forces the chip back toward the surface.

Radial rake has a major effect on tangential and radial forces. Positive axial rake reduces these forces, minimizing burrs and break-out.

Double negative cutters provide economy and the edge strength required for hard materials and interrupted cuts. But strength is often not required on light finishing cuts and economic gains may

Fig. 2: Effect of Spindle Tilt on Various Cutter Diameters

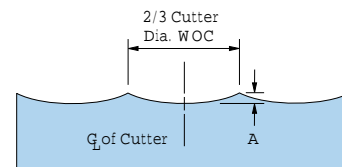

Spindle Tilt	Cutter Dia.	A
.001" per foot	6"	.00006"
	12"	.00013"
	18"	.00019"
.003" per foot	6"	.00019"
	12"	.00038"
	18"	.00057"
.005" per foot	6"	.00032"
	12"	.00064"
	18"	.00095"
.008" per foot	6"	.00051"
	12"	.00102"
	18"	.00153"

be offset by the time spent trying to attain a desired finish. Double negative geometry "pushes" rather than cuts. These higher forces consume more horsepower and create more pressure and heat.

Double positive cutters offer freer cutting action and consume less horsepower but have weaker cutting edges. Lower cutting forces direct less force against the workpiece and machine, so there is less tendency to chatter or deflect. Remember, however, that too high a positive angle can tend to reverse the force and lift the workpiece into the cutter.

Negative/positive cutters provide the best cutting geometry for finish milling. Positive axial rake, negative radial rake, and the proper lead angle cause chips to be lifted up and out from the finished surface to clear the cutter and workpiece. This type of cutter combines the best aspects of negative and positive

Fig. 1

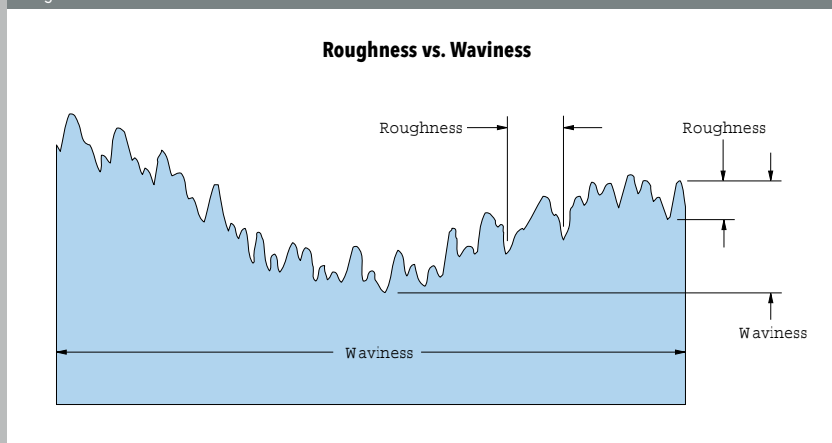

geometries and provide extremely free cutting action. Excellent chip evacuation leaves the finish-milled surface free of scratches and scoring.

Lead angle also affects cutting forces. Increasing the lead angle from 0° lessens radial force slightly and increases axial force significantly. Generally, chip evacuation is easier with a higher lead angle.

Insert design. One common insert design has a wiping flat on the face of the insert. The width of this flat must be greater than the advance per revolution to allow the cutting edges to overlap. Spindle tilt is critical when using wipers. Due to the sharp ends on the insert, excessive spindle tilt can cause dig-in (Fig. 3).

The MICRO MILL insert has four radiused cutting edges which project a very shallow ellipse in the plane of the cut. The large elliptical radius aligns to the surface regardless of spindle tilt. This ensures that the ends of the cutting edge do not dig-in the surface as can occur when inserts with conventional flats are used.

The cutting edge is ground with a hook as well as a radius so that the axial rake is positive. This creates a shearing action which eases entry into the cut and directs chips up and away so they do not cause scratches. With this type of insert, however, if the advance per revolution is too great, the elliptical cutting edges will not overlap enough to form a smooth surface finish.

Other recommendations. Climb milling is generally best for finish milling because the cutter takes the thick part of the chip when it enters the cut. In conventional milling, the chip thickness starts at zero, causing rubbing or burnishing before the chip can reach its full thickness. Pressure and heat build up at the finished surface. The thin section will then weld to the cutting edge and be carried around to scratch the surface.

Avoid cutting with the full diameter of the tool. This also results in zero chip thickness at the point of cutting edge entry just as in conventional milling. Two-thirds of the tool diameter is best when finish milling. It is also important to cut in the same direction when consecutive passes are required.

Finish milling depths are usually light (.003"-.010"). Greater Advance Per Tooth (APT) can be used, sometimes as high as .125". Finish milling cutters should be less dense than rough or semi-finish cutters, although high-density cutters may be required for some high production cast iron applications.

Fig. 3

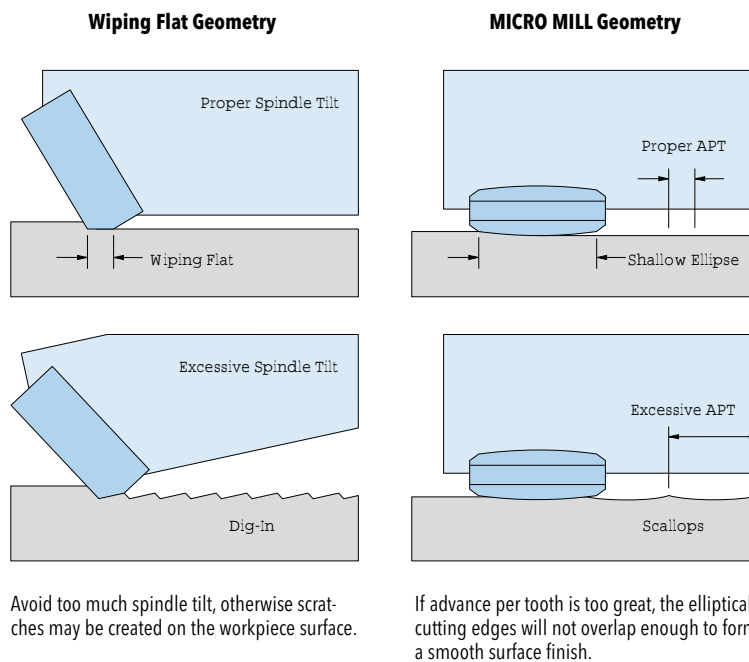

RIGIDITY ANALYSIS

MAXIMIZING RIGIDITY WILL IMPROVE END MILL PERFORMANCE

Rigidity

Among the many variables in milling, rigidity is one of the most important. Quite often, it is the primary factor determining end mill performance. Due to their length-to-diameter ratio, end mills are the least rigid of all cutting tools. Understanding rigidity and maximizing it can dramatically increase end milling productivity.

Some of the primary factors that affect rigidity are basic machine design, drive mechanism, bearing placement, spindle size, tool diameter and length, overhang, workpiece, and fixturing. This discussion will focus on how end mill selection affects rigidity.

Rigidity: is affected by cutting force. Cutting force produces deflection.

Force: is produced by a combination of cutting speed in Surface Feet per Minute (SFM) and power. Power is a function of the width and depth of cut, feed rate, and the material being cut. Soft materials require less power and hard materials require more.

Deflection: is produced by the cutting force on the tool. The tool's length-to-diameter ratio determines the degree of effect cutting force has on the tool.

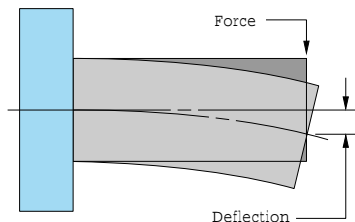

Deflection is directly proportional to L^3 (length to the third power) and inversely proportional to D^4 (diameter to the fourth power). In other words, deflection is radically reduced as diameter is increased and/or length is reduced.

Ingersoll has designed computer software to perform the many calculations required to determine the amount of deflection on the tool. Using Ingersoll's "Rigidity Analysis" software, deflection for the following example can easily be determined:

Cutter: 2.000" diameter, 4.00" flute length, No. 50 V-Flange adaption
Material: Low carbon steel
Speed: 400 SFM
Radial DOC: 1.00"
Axial DOC: 2.00"
Feed 12 IPM (.008 IPT)

The calculated theoretical deflection is .007".

Deflection of .001" or less is recommended for end milling operations. This example exceeds the desired maximum deflection of .001". A cutter running under these conditions is likely to chatter, produce a poor surface finish, and exhibit reduced tool life.

The same example was recalculated after reducing the flute length from 4.00" to 3.00". Without making any other changes, the rigidity of the end mill improved dramatically. The theoretical deflection was reduced to .0009".

By reducing the overall length-to-diameter ratio by 25 percent, deflection was reduced to less than half of the original example.

Many operational variables require additional rigidity. Among these are brittle cutting edge materials and any factor causing an increase in cutting forces such as negative cutting angles or tougher workpiece materials.

Tool Adaption

Rotary Toolholder: Most end mills are run in rotary toolholders which connect the tool to the spindle. Ironically, due to the added length and extra joint, this is the least rigid of all end mill adaptations. To maximize rigidity with this adaptation, an end mill with the largest diameter shank and the shortest adaptor possible should be used.

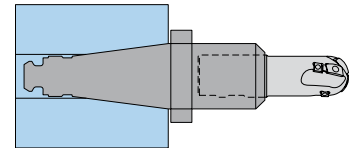

Poor: Straight shank end mill and rotary toolholder

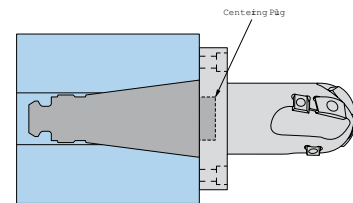

Better: Integral Shank

RIGIDITY ANALYSIS

Integral Shank: An improvement over the straight shank adaption is an integral shank. This eliminates the joints required with rotary tool holders and greatly improves length-to-diameter ratios. Many standard Ingersoll end mills are available with No. 50 taper adaptors. Other tapers are available upon request.

No. 50 tapers have a standard .125" gap between the flange and spindle face. To eliminate the gap, many Ingersoll machines have a simultaneous fit adaptor designed to be used in conjunction with a precision spindle face. Because the adaptor flange has bearing on the spindle face, the joint is more rigid.

Flat Back Drive: Another way to eliminate the .125" gap is to use a flat back drive system. It consists of a centering plug with a pilot diameter on the spindle. The end mill is bolted directly to the spindle face. This adaption is often used for large, heavy-duty end mill operations requiring maximum rigidity.

HSK Adaption: The HSK tool holder is designed to provide simultaneous fit on both the spindle face and the spindle taper.

At high speeds, centrifugal force causes the spindle to grow slightly. The face contact prevents the tool from moving up the bore. The hollow shank design is also susceptible to centrifugal force but is designed to grow with the spindle bore at very high speeds. I.D. clamping actually tightens its grip as spindle speed increases.

Supporting the cutting tool and holder in both the axial and radial planes creates a significantly more rigid connection between the tool and spindle.

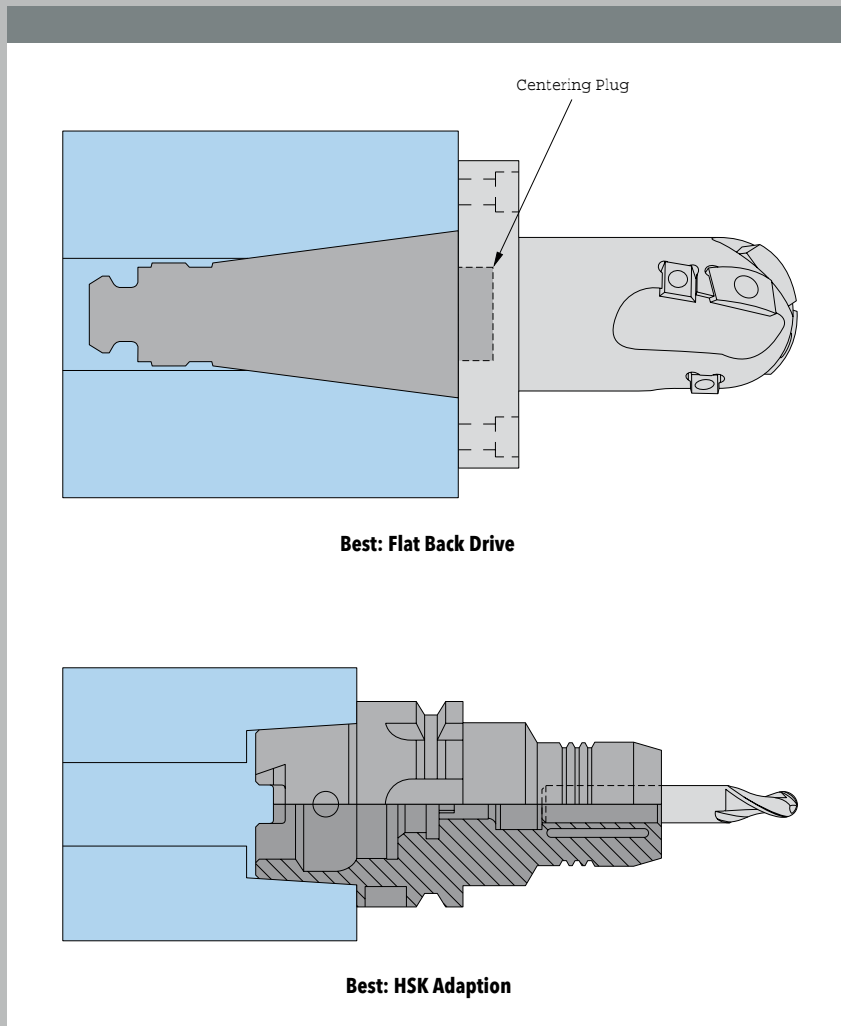

Moreover, HSK end mill holders are available in a variety of clamping styles including shrink fit for solid carbide shanks; hydraulic for steel shanks, collet, and Weldon styles. Choose the most rigid and accurate assembly possible.

Other HSK advantages include lighter weight, lower deflection under load, extremely accurate repeatability, increased torque transfer capabilities, and significantly improved dynamic runout over 50-taper adaptions at high speeds.

RADIAL CHIP THINNING

INCREASE FEED RATES BY UNDERSTANDING AND APPLYING RADIAL CHIP THINNING FACTORS

Radial Chip Thickness

Limitations on a cutting tool's performance are generally established in terms of maximum chip load. Since commonly used speed and feed calculators show only Advance Per Tooth (APT), chip load and APT tend to be used interchangeably. This is an area of misunderstanding which can be significant. Chip load actually refers to chip thickness, not APT.

APT is defined as the increment of feed that takes place in the time necessary for the cutter to rotate the distance between cutting edges. Mathematically, it is:

$$APT = \frac{IPM}{RPM \times T}$$

where:

- IPM = Feed rate (inches/min)
- RPM = Spindle speed (rev/min)
- T = Teeth

The chip thickness is the "bite" taken by each cutting edge as it performs its work. For a typical end mill in a radial

Depth Of Cut (DOC) exceeding two-thirds the diameter of the cutter, the chip thickness increases until it equals the APT at the centerline of the cutter. The chip thickness then decreases to nothing as the cutting edge exits the cut (Figure 1).

Thus, APT is a constant for a given operation and the chip thickness is variable, changing cyclically.

Peripheral cutting: When end mill cuts are shallow in relation to the cutter diameter, the Actual Chip Thickness (ACT) is less than the APT. This chip thinning effect allows much higher feed rates (Figure 2).

For example, assume the following parameters:
 2.000" diameter end mill
 Two-effective
 500 Surface Feet per Minute (SFM)
 .12" radial Width Of Cut (WOC)
 .005" chip thickness
 955 effective RPM

Even though the APT in this case is .0105", the ACT (or chip load) is only .005".

A two-effective, 2.000" diameter end mill had an APT of .0105" and a chip thickness of only .005". The Radial Chip Thinning Factor (RCTF) is the ratio of chip thickness to APT or, in this example, .48.

Mathematically, the RCTF can be expressed as: where:

$$RCTF = \sqrt{1 - \left[1 - \frac{2 \times WOC}{Eff. Dia.} \right]^2}$$

- D = Diameter of cutter
- WOC = Radial Width Of Cut

Whenever the radial DOC is equal to or greater than the effective cutter radius, the RCTF is equal to 1.

Fig. 1

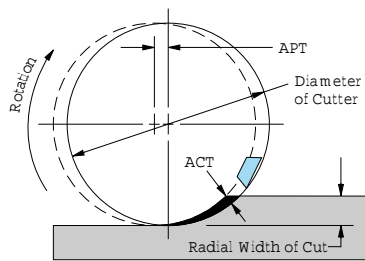

Chip thickness equals the Advance Per Tooth at the centerline of the cutter.

Fig. 2

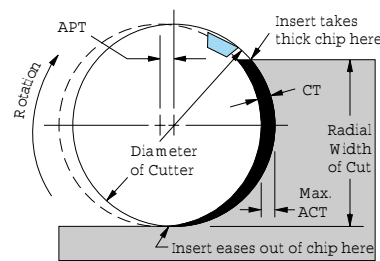

Chip thickness is less than the Advance Per Tooth.

Fig. 3: Radial Chip Thinning Factors for Peripheral Milling

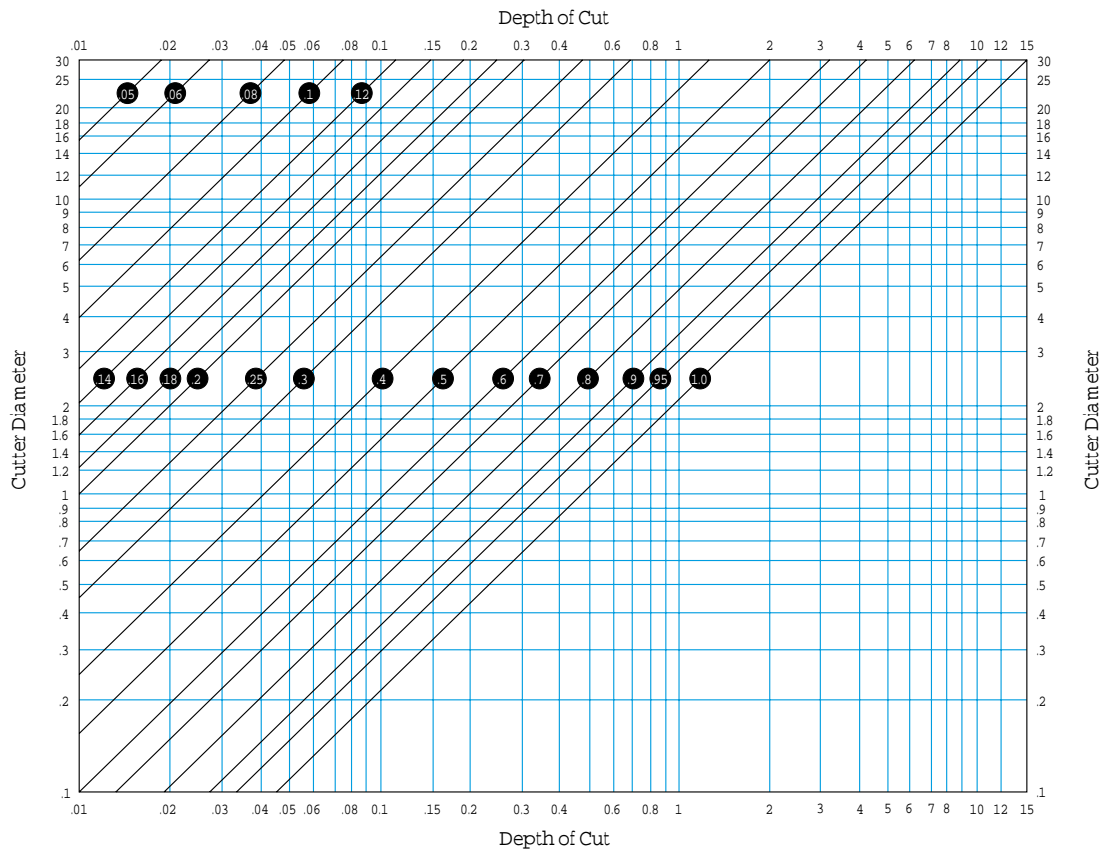

To find the Radial Chip Thinning Factor for a slabbing cut:

1. Find the Depth of Cut on the horizontal scale.
2. Locate the nominal diameter of the cutter on the vertical axis.
3. Cross-reference the two figures.
4. Locate the diagonal line closest to the intersection of the vertical and horizontal axes.
The value of this diagonal is the Radial Chip Thinning Factor for your specific application.

The RCTF can also be found with the help of the graph in Figure 3.

A thorough understanding of the relationship between APT and chip thickness enables the tool engineer to establish optimum feed rates for a cutting tool. After determining the RCTF, the maximum permissible chip load is divided by the RCTF to arrive at the optimum APT.

Again, referring to the example, the chip load of .005" is divided by the RCTF of .48 to arrive at the optimum APT of .0105". This APT should be used in calculating the feed rate, in this case, 20.1 IPM.

In addition to increasing productivity, applying the RCTF can improve a cutter's performance. At the higher feed rate, the insert will be taking a true bite. At lower feed rates without applying the RCTF, the insert may rub instead of cut and produce chatter, building heat and compromising tool life.

BALL NOSE "STURZ" MILLING

Ball Nose Milling. Ball nose end milling is a unique application that presents unique challenges. The nose inserts on a ball nose end mill are subjected to extreme abnormal and inconsistent work stresses. This is due, in part, to the wide variance in SFM and chip load from the radial to the axial end of the insert.

In order to minimize the stresses generated by this condition, the spindle axis can be tilted to raise the center point of the tool out of the cut (Figure 2). This "sturz" milling greatly reduces the force variance on the insert and helps to equalize the chip load.

To utilize this technique in optimizing your ball nose milling application, you must be able to tilt your machine spindle relative to the workpiece

Axial Chip Thickness

Effective Diameter: When applying ball nose end mills, quite often the full diameter of the cutter is not engaged in the work. Since ball nose end mills cut to center, the speed in SFM is reduced to 0 as the centerline of the cutter is reached (see Figure 1 below).

To determine the Axial Chip Thinning Factor (ACTF), first determine the effective cutting diameter.

As the DOC varies, so does the effective cutting diameter. Since SFM calculations are based on the diameter of the cutter engaged in the cut, they must be made at the effective cutting diameter, not the nominal diameter of the tool.

Fig. 2

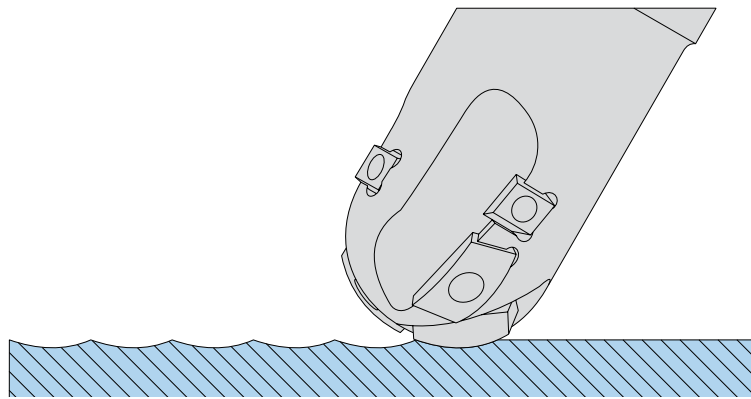

"Sturz" milling, or tilting the axis of the spindle to move the axial center of a ball nose end mill out of the cut, greatly reduces the cutting forces inflicted on the nose insert.

The effective cutting diameter can be found in Chart A on pages M466-M467 by using the nominal tool diameter at the top and the DOC on the side. The SFM is calculated using the resulting effective cutting diameter at DOC.

The effective cutting diameter can also be calculated by using the following formula: Where:

$$D_t = 2 \times \sqrt{R^2 - (R - D)^2}$$

D_t = True cutting Diameter (in.)
 R = Radius (in.)
 D = Depth of cut (in.)

In order to achieve the best productivity possible, be sure to consider the effective cutting diameter when setting RPM for a profiling ball nose application.

Chip Thickness

Due to the spherical form presented to the workpiece, axial chip thinning can affect chip thickness the same way as a lead angle on a face mill. This can have an adverse effect on the performance of a ball nose end mill. The ACTF must be applied when calculating the desired chip thickness and resulting feed rate.

The ACTF is determined by the radius of the ball nose at a given DOC. Figure 2 illustrates the concept of axial chip thinning. Notice as the axial DOC increases, so does the axial chip thickness. To calculate axial chip thickness:

$$ACTF = \sqrt{1 - 1 \left[\frac{2 \times DOC^2}{Ctr. Dia.} \right]}$$

Whenever the axial DOC is equal to or greater than the radius of the ball nose, the ACTF is equal to 1.

Next, determine the RCTF by the chart on pages M466-M467 or the formula. As Figure 3 shows, the RCTF is determined by the radius of the cutter at a given radial DOC. When determining the RCTF, use the effective diameter of the ball nose rather than the cutter diameter. Radial DOC is the same as the radial "step over." The formula used to calculate axial chip thinning is the same as that used for radial chip thinning. Ultimately, the purpose of determining the chip thinning factor is to optimize the feed rate.

Fig. 1: Effective Diameter

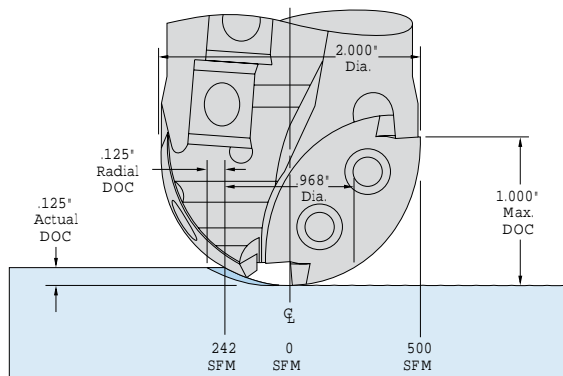

In this example, the SFM is 500 at a 2.000" diameter. The effective cutting diameter is .968", at which point, the SFM is 242. The RPM must be increased to 1973 in order to achieve 500 SFM at the .968" effective cutting diameter.

Fig. 2: Axial Chip Thinning

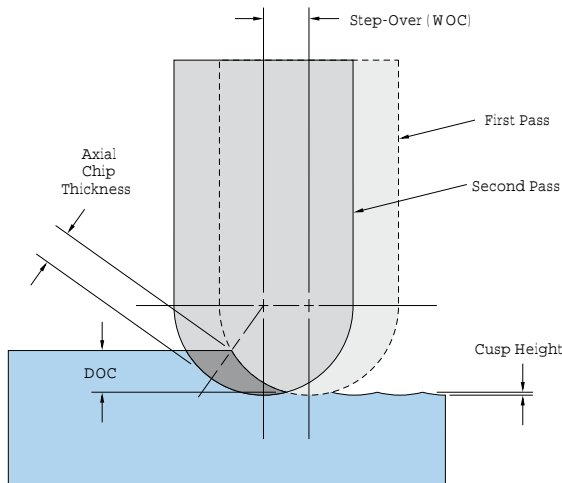

To calculate the proper feed rate, first multiply the ACTF by the RCTF. This result is the Feed Correction Factor (FCF):

$$FCF = RCTF \times ACTF$$

Divide the desired chip thickness by the FCF. This result is the desired APT to maintain proper chip thickness:

$$APT = \frac{CT}{FCF}$$

Finally, to arrive at the feed rate in Inches Per Minute (IPM), multiply the APT by the number of effective flutes and the RPM:

$$IPM = RPM \times (\text{No. of Flutes})$$

Overall performance would also improve since the cutter would be taking a true "bite" at the new feed rate. At the lower feed rate, the carbide may rub rather than cut.

Example

Figure 1 shows a 2.000" diameter ball nose end mill running at .125" DOC and a .125" radial DOC (step over). the effective diameter at this DOC is .968" (see chart on page M463). If the desired SFM is 500, the RPM would normally be set at 955 RPM for a 2.000" diameter cutter. However, since the effective

diameter is .968", the RPM should be set at 1973 to achieve 500 SFM. This is an increase of more than 100 percent.

The DOC also affects the feed rate due to axial chip thinning. At .125" DOC, a 2.000" diameter has a chip thinning factor of .48 (see chart on M463). If the desired chip thickness is .010", the feed rate will need to be increased more than 100 percent. Without chip thinning, the feed rate would be set at 19.7 IPM (1973 x .010"). However, at this DOC, the ACT would be only .0048" (.010 x .48). To achieve the proper chip thickness (APT or ACT), divide the desired chip thickness by the chip thinning factor.

$$\frac{.010"}{.48} = .021" \text{ APT}$$

The feed rate would be:

$$1973 \text{ RPM} \times .021 = 41.4 \text{ IPM}$$

In the same manner, the radial DOC (step over) has the same effect on feed rate. The radial DOC on a ball nose end mill is the same as the

radial WOC on an end mill or face mill. In this example, the radial DOC of .125" has an RCTF of .67 (see chart on page M463).

To achieve the desired chip thickness of .010", multiply the ACTF by the RCTF resulting in the FCF.

$$.48 \text{ ACTF} \times .67 \text{ RCTF} = .32 \text{ FCF}$$

The APT is:

$$\frac{.010"}{.32} = .021" \text{ APT}$$

Productivity in this example is three times greater by using the correct chip thinning factors. On a single flute, one-effective tool using this example, the feed rate should be set at:

$$1973 \text{ RPM} \times .031" \text{ APT} = 61.3 \text{ IPM}$$

At this feed rate, productivity is increased over 200 percent by using the proper chip thinning factors.

Ingersoll Cutting Tool Company provides speed and feed selectors which are designed to help obtain optimum speed, feed, and ACT multipliers. Ask your Ingersoll sales engineer for a complimentary selector.

Fig. 3: Radial Chip Thinning at Effective Diameter

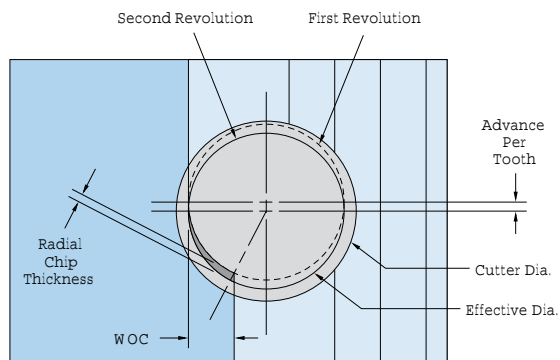

BALL NOSE CHIP THINNING

This chart provides information on effective cutting diameter, ACTFs, and cusp height for a ball nose cutter at a given DOC or step over.

Effective Diameter and Axial Chip

Thinning Factor. Axial DOC will affect the effective cutting diameter and, consequently, the ACTF. Note that as the axial DOC increases, the effective diameter and ACTF also increase.

A lower DOC results in a smaller effective diameter and, therefore, a lower ACTF; i.e., the spindle RPM and feed rate need to be increased to maintain a proper surface speed and chip load.

Cusp Height. Step over, or radial DOC, affects the cusp height. Cusp height is the theoretical surface finish produced by successive tool

paths made by a radius tool. Larger step over or a smaller cutter diameter produces a larger cusp height; i.e. a rougher finish.

For the best surface finish, use the largest diameter tool possible at the lowest practical radial DOC.

CHART A - EFFECTIVE BALL NOSE CUTTING DIAMETER, AXIAL CHIP THINNING FACTORS, AND CUSP HEIGHT (.375"-1.000" DIA.)

DOC/ Step Over	Cutter Diameter														
	0.375			0.500			0.625			0.750			1.000		
	Dia.	ACTF	Cusp	Dia.	ACTF	Cusp	Dia.	ACTF	Cusp	Dia.	ACTF	Cusp	Dia.	ACTF	Cusp
0.004	0.08	0.21	0.0000107	0.09	0.18	0.0000080	0.10	0.16	0.0000064	0.11	0.15	0.0000053	0.13	0.13	0.0000040
0.008	0.11	0.29	0.0000427	0.13	0.25	0.0000320	0.14	0.22	0.0000256	0.15	0.21	0.0000213	0.18	0.18	0.0000160
0.016	0.15	0.40	0.0001707	0.18	0.35	0.0001280	0.20	0.32	0.0001024	0.22	0.29	0.0000853	0.25	0.25	0.0000640
0.031	0.21	0.55	0.0006522	0.24	0.48	0.0004888	0.27	0.44	0.0003909	0.30	0.40	0.0003257	0.35	0.35	0.0002442
0.063	0.28	0.75	0.0026225	0.33	0.66	0.0019608	0.38	0.60	0.0015664	0.41	0.55	0.0013044	0.48	0.48	0.0009775
0.094	0.32	0.87	0.0059539	0.39	0.78	0.0044338	0.45	0.71	0.0035356	0.50	0.66	0.0029412	0.58	0.58	0.0022021
0.125	0.35	0.94	0.0107233	0.43	0.87	0.0079385	0.50	0.80	0.0063138	0.56	0.75	0.0052450	0.66	0.66	0.0039216
0.156	0.35	0.99	0.0170514	0.46	0.93	0.0125206	0.54	0.87	0.0099232	0.61	0.81	0.0082283	0.73	0.73	0.0061412
0.188	0.38	1.00	0.0251202	0.48	0.97	0.0182438	0.57	0.92	0.0143940	0.65	0.87	0.0119078	0.78	0.78	0.0088677
0.219				0.50	0.99	0.0251954	0.60	0.95	0.0197657	0.68	0.91	0.0163050	0.83	0.83	0.0121095
0.250							0.61	0.98	0.0260890	0.71	0.94	0.0214466	0.87	0.87	0.0158771
0.281							0.62	0.99	0.0334286	0.73	0.97	0.0273657	0.90	0.90	0.0201827
0.313							0.63	1.00	0.0418671	0.74	0.99	0.0341027	0.93	0.93	0.0250411
0.344										0.75	1.00	0.0417074	0.95	0.95	0.0304694
0.375										0.75	1.00	0.0502405	0.97	0.97	0.0364876
0.406													0.98	0.98	0.0431190
0.438													0.99	0.99	0.0503908
0.469													1.00	1.00	0.0583346
0.500													1.00	1.00	0.0669873

BALL NOSE CHIP THINNING

CHART A - EFFECTIVE BALL NOSE CUTTING DIAMETER, AXIAL CHIP THINNING FACTORS, AND CUSP HEIGHT (1.250"-3.000" DIA.)

DOC/ Step Over	Cutter Diameter														
	1.250			1.500			2.000			2.500			3.000		
	Dia.	ACTF	Cusp	Dia.	ACTF	Cusp	Dia.	ACTF	Cusp	Dia.	ACTF	Cusp	Dia.	ACTF	Cusp
0.004	0.14	0.11	0.0000032	0.15	0.10	0.0000027	0.18	0.09	0.0000020	0.20	0.08	0.0000016	0.22	0.07	0.0000013
0.008	0.20	0.16	0.0000128	0.22	0.15	0.0000107	0.25	0.13	0.0000080	0.28	0.11	0.0000064	0.31	0.10	0.0000053
0.016	0.28	0.22	0.0000512	0.31	0.21	0.0000427	0.36	0.18	0.0000320	0.40	0.16	0.0000256	0.44	0.15	0.0000213
0.031	0.39	0.31	0.0001953	0.43	0.29	0.0001628	0.50	0.25	0.0001221	0.56	0.22	0.0000977	0.61	0.20	0.0000814
0.063	0.54	0.44	0.0007817	0.60	0.40	0.0006513	0.70	0.35	0.0004884	0.78	0.31	0.0003907	0.86	0.29	0.0003256
0.094	0.66	0.53	0.0017603	0.73	0.48	0.0014663	0.85	0.42	0.0010992	0.95	0.38	0.0008792	1.04	0.35	0.0007326
0.125	0.75	0.60	0.0031329	0.83	0.55	0.0026087	0.97	0.48	0.0019550	1.09	0.44	0.0015635	1.20	0.40	0.0013026
0.156	0.83	0.66	0.0049020	0.92	0.61	0.0040801	1.07	0.54	0.0030564	1.21	0.48	0.0024438	1.33	0.44	0.0020359
0.188	0.89	0.71	0.0070713	0.99	0.66	0.0058824	1.17	0.58	0.0044042	1.32	0.53	0.0035206	1.45	0.48	0.0029326
0.219	0.95	0.76	0.0096447	1.06	0.71	0.0080181	1.25	0.62	0.0059994	1.41	0.57	0.0047944	1.56	0.52	0.0039929
0.250	1.00	0.80	0.0126276	1.12	0.75	0.0104900	1.32	0.66	0.0078433	1.50	0.60	0.0062657	1.66	0.55	0.0052174
0.281	1.04	0.84	0.0160258	1.17	0.78	0.0133015	1.39	0.70	0.0099371	1.58	0.63	0.0079353	1.75	0.58	0.0066063
0.313	1.08	0.87	0.0198464	1.22	0.81	0.0164566	1.45	0.73	0.0122825	1.65	0.66	0.0098041	1.83	0.61	0.0081602
0.344	1.12	0.89	0.0240974	1.26	0.84	0.0199596	1.51	0.75	0.0148812	1.72	0.69	0.0118728	1.91	0.64	0.0098795
0.375	1.15	0.92	0.0287880	1.30	0.87	0.0238156	1.56	0.78	0.0177354	1.79	0.71	0.0141425	1.98	0.66	0.0117649
0.406	1.17	0.94	0.0339287	1.33	0.89	0.0280303	1.61	0.80	0.0208472	1.84	0.74	0.0166143	2.05	0.68	0.0138169
0.438	1.19	0.95	0.0395314	1.36	0.91	0.0326100	1.65	0.83	0.0242191	1.90	0.76	0.0192895	2.12	0.71	0.0160362
0.469	1.21	0.97	0.0456095	1.39	0.93	0.0375617	1.69	0.85	0.0278537	1.95	0.78	0.0221692	2.18	0.73	0.0184237
0.500	1.22	0.98	0.0521780	1.41	0.94	0.0428932	1.73	0.87	0.0317542	2.00	0.80	0.0252551	2.24	0.75	0.0209801
0.531	1.24	0.99	0.0592542	1.43	0.96	0.0486133	1.77	0.88	0.0359236	2.05	0.82	0.0285487	2.29	0.76	0.0237062
0.563	1.24	0.99	0.0668572	1.45	0.97	0.0547314	1.80	0.90	0.0403655	2.09	0.84	0.0320515	2.34	0.78	0.0266031
0.594	1.25	1.00	0.0750089	1.47	0.98	0.0612582	1.83	0.91	0.0450837	2.13	0.85	0.0357656	2.39	0.80	0.0296717
0.625	1.25	1.00	0.0837341	1.48	0.99	0.0682055	1.85	0.93	0.0500822	2.17	0.87	0.0396927	2.44	0.81	0.0329132
0.656				1.49	0.99	0.0755862	1.88	0.94	0.0553657	2.20	0.88	0.0438350	2.48	0.83	0.0363286
0.688				1.49	1.00	0.0834147	1.90	0.95	0.0609388	2.23	0.89	0.0481947	2.52	0.84	0.0399192
0.719				1.50	1.00	0.0917070	1.92	0.96	0.0668068	2.26	0.91	0.0527742	2.56	0.85	0.0436863
0.750				1.50	1.00	0.1004809	1.94	0.97	0.0729752	2.29	0.92	0.0575760	2.60	0.87	0.0476312
0.781							1.95	0.98	0.0794501	2.32	0.93	0.0626028	2.63	0.88	0.0517555
0.813							1.96	0.98	0.0862380	2.34	0.94	0.0678575	2.67	0.89	0.0560606
0.844							1.98	0.99	0.0933460	2.36	0.95	0.0733431	2.70	0.90	0.0605482
0.875							1.98	0.99	0.1007816	2.38	0.95	0.0790629	2.73	0.91	0.0652200
0.906							1.99	1.00	0.1085530	2.40	0.96	0.0850203	2.75	0.92	0.0700777
0.938							2.00	1.00	0.1166691	2.42	0.97	0.0912190	2.78	0.93	0.0751234
0.969							2.00	1.00	0.1251395	2.44	0.97	0.0976629	2.81	0.94	0.0803589
1.000							2.00	1.00	0.1339746	2.45	0.98	0.1043561	2.83	0.94	0.0857864
1.031										2.46	0.98	0.1113030	2.85	0.95	0.0914082
1.063										2.47	0.99	0.1185083	2.87	0.96	0.0972265
1.094										2.48	0.99	0.1259770	2.89	0.96	0.1032439
1.125										2.49	0.99	0.1337143	2.90	0.97	0.1094628
1.156										2.49	1.00	0.1417259	2.92	0.97	0.1158860
1.188										2.50	1.00	0.1500178	2.93	0.98	0.1225164
1.219										2.50	1.00	0.1585963	2.95	0.98	0.1293570
1.250										2.50	1.00	0.1674682	2.96	0.99	0.1364110
1.281													2.97	0.99	0.1436816
1.313													2.98	0.99	0.1511724
1.344													2.98	0.99	0.1588870
1.375													2.99	1.00	0.1668294
1.406													2.99	1.00	0.1750037
1.438													3.00	1.00	0.1834141
1.469													3.00	1.00	0.1920652
1.500													3.00	1.00	0.2009619

FORMMASTER SPEED OPERATING GUIDELINES SERIES 15V1E, 15VIH

EXAMPLE CALCULATION

GIVEN	STEP 1	STEP 2	STEP 3	STEP 4	OPERATING PARAMETERS
<ul style="list-style-type: none"> ■ CUTTER = 5V6E-20R01 ■ INSERT = UHLD08T310R-M ■ NUMBER OF INSERTS = 5 ■ MATERIAL = H13 PRE-HARD ■ HARDNESS = 38-42 HRC ■ EXTENSION LENGTH = 6.00" 	CONVERT 38-42 HRC TO BRINELL THEN SELECT SURFACE FEET PER MINUTE (SFM). CALCULATE RPM FOR A 2.00" DIA. CUTTER	SELECT DEPTH OF CUT AND FEEDRATE MULTIPLIER FROM THE APPLICATION TABLE FOR RATIO OF 3:1	SELECT CHIP THICKNESS (CT) FOR THE UHLD08T310R-M INSERT IN H13	CALCULATE FEEDRATE (FULL WIDTH OF CUTTER)	<ul style="list-style-type: none"> ■ RPM - 860 ■ DEPTH OF CUT = .04" ■ FEEDRATE = 172 IPM ■ WIDTH OF CUT = 2.00"
	*RPM = 860 (450 SFM)	DOC = .04" FRM MULTIPLIER = 4	0.010"	**FEEDRATE = 172 IPM	

*RPM = SFM x 3.82 / Cutter Diameter **Feedrate = RPM x # of inserts x CT x FRM

APPLICATION TABLE

	GREATER THAN 8:1	FROM 3:1 TO 8:1	LESS THAN 3:1
	FROM .01" TO .03"	FROM .02" TO .06"	FROM .04" TO .08"
	3	4	5

MATERIAL HARDNESS

BRINELL (HB)	ROCKWELL (HRC)
200	15
225	20
250	24
275	29
300	32
325	34
350	38
375	40
400	43
425	46

FIGURE 1

PROGRAM ALL FORMMASTERSPEED CUTTERS AS THOUGH THEY ARE BULLNOSE CUTTERS WITH .118"/ 3.0MM CORNER RADII. THIS METHOD WILL BOTH ENSURE AND MINIMIZE REMAINING STOCK FOR SECONDARY PASSES.

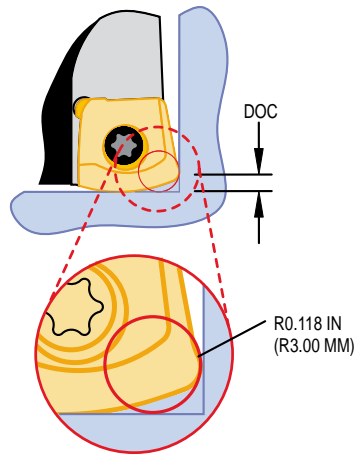

RAMP ANGLES

INCHES	.750"	1.000"	1.250"	1.500"	2.000"	NA	3.000"	4.000"
	MM	20.00 MM	25.00 MM	32.00 MM	42.00 MM	66.00 MM	80.00 MM	NA
	3.5 DEG	3.0 DEG	2.5 DEG	1.6 DEG	1.2 DEG	0.7 DEG	0.5 DEG	0.2 DEG

FAST BREAK PROGRAMMING DIMENSIONS

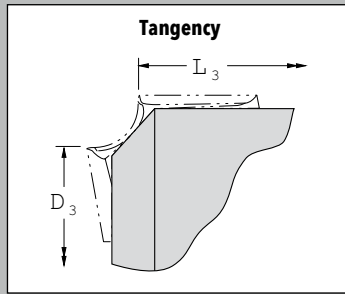

D1 Nominal Diameter	Cutter Body	Insert Corner	Inserts	D3 Program Diameter	L3 Program Length
0.750	15R1V-0702084R01	0.031"	BEEW120308R-CR	0.684	1.985
		0.062"	BEEW120316R-CR	0.623	1.949
		0.094"	BEEW120325R-CR	0.552	1.909
		0.125"	BEEW120332R-CR	0.495	1.876
		1.0 mm	BEEW120310R-CR	0.670	1.976
		2.0 mm	BEEW120320R-CR	0.589	1.930
		3.0 mm	BEEW120330R-CR	0.512	1.885
1.000	15R1V-1002080R01	0.031"	BEEW120308R-CR	0.934	1.984
		0.062"	BEEW120316R-CR	0.873	1.949
		0.094"	BEEW120325R-CR	0.802	1.909
		0.125"	BEEW120332R-CR	0.745	1.875
		1.0 mm	BEEW120310R-CR	0.920	1.976
		2.0 mm	BEEW120320R-CR	0.839	1.930
		3.0 mm	BEEW120330R-CR	0.762	1.885
1.000	15R1V-10015X7R01	0.031"	BEEW120308R-CR	0.934	1.484
		0.062"	BEEW120316R-CR	0.873	1.449
		0.094"	BEEW120325R-CR	0.802	1.409
		0.125"	BEEW120332R-CR	0.745	1.375
		1.0 mm	BEEW120310R-CR	0.920	1.476
		2.0 mm	BEEW120320R-CR	0.839	1.430
		3.0 mm	BEEW120330R-CR	0.762	1.385
1.000	15R4H-1002080R01	.156"	FEEW250340R-CR	0.697	1.881
		.187"	FEEW250348R-CR	0.644	1.846
		.250"	FEEW250364R-CR	0.500	1.750
		4.0 mm	FEEW250340R-CR	0.697	1.881
		5.0 mm	FEEW250350R-CR	0.611	1.825
		6.0 mm	FEEW250360R-CR	0.530	1.771
1.000	15R4H-10015X7R01	.156"	FEEW250340R-CR	0.697	1.631
		.187"	FEEW250348R-CR	0.644	1.596
		.250"	FEEW250364R-CR	0.500	1.500
		4.0 mm	FEEW250340R-CR	0.697	1.631
		5.0 mm	FEEW250350R-CR	0.611	1.575
		6.0 mm	FEEW250360R-CR	0.530	1.521

GENERAL TECHNICAL INFORMATION

TROUBLESHOOTING CHART

Solution	Problem	Chipping Fracturing	Excessive Abrasive Flank Wear	Cratering Chemical Wear	Built Up Edge	Deformation	Thermal Cracking	"Bad Surface Finish"	Vibration/Chatter	"Chip Built Up (Chip Tangled Up"	"Edge of Material Breaks"	"Cutting Forces too high". Machine overload
Cutting Speed		1	2	2	1	2		1	3			2
APT		2	1	2	1	2	2	2	3		2	2
Toughness of Cutting Material		1					1					
Wear Resistance			1	1		1,3						
Entering Angle					3				2	3	2	2
Rake Angle		2			1,3	1,3	3		1	3		
Chamfer		1			3		2				2	
Stabilize Fixture/Part		1					1	1	1			
Tool Position							3	3	3		3	
Coolant, Chip Removal				1	1	3		3		3		
DOC		3					3	3	3		2	2
Runout/Concentricity								1	1		3	

- 1-Increase
- 2-Decrease
- 3-Optimize

GENERAL TECHNICAL INFORMATION

SYMBOLS DEFINED

Explanation of catalog parameters and formula symbols

Symbol	Unit	Designation
D	Inch	Nominal diameter
n	min ⁻¹	RPM
a _e	Inch	Width of cut
a _p	Inch	Cutting depth
f _z	Inch	Feed per tooth
f	Inch/U	Feed per revolution
h _m	Inch	Average chip thickness
Q	ft ³ /min	Chip removal rate
v _c	Inch/min	Feed rate
C	x 45°	Chamfer
R	-	Radius

GENERAL FORMULI FOR MILLING OPERATIONS

Value	Unit	Formula
RPM	min ⁻¹	$n = \frac{v_c \times 1000}{D \cdot \pi}$
Cutting speed	ft/min	$v_c = \frac{D \cdot \pi \cdot n}{1000}$
Feed rate	in/min	$v_f = f_z \cdot Z_{\text{eff}} \cdot n$
Feed per tooth	in	$f_z = \frac{v_f}{Z_{\text{eff}} \cdot n}$
Chip removal rate	in ³ /min	$Q = \frac{a_e \cdot a_p \cdot v_f}{1000}$
Average chip thickness	in	$h_m = f_z \cdot \sqrt{a_e/D}$

GENERAL TECHNICAL INFORMATION

MILLING GRADES

New Grade	Coating	OLD GRADE	Cast Iron	Stainless Steel	Steel	Non-Ferrous Alloys	Hi Temp. Alloys	Hardened Steel	U.S. Industry Code	ISO Code	Mech. Shock	Thermal Shock	Wear Resistance	Crater Resistance	Grain
IN04S	None	110, 103				•			C-3	K10-K20	L	L	H	VL	Micro
IN05S	None					•			C-1	M10-M20	M	L	H	VL	Micro
IN10K	None	111				•			C-1/C-2	K20-K40	L	L	H	VL	Fin.- Med.
IN15K	None	205H				•			C-1/C-2	K20-K40	H	L	M	VL	Micro
IN30M	None	205S, 131				•	•		C-1/C-2	M20-M40, K20-K50	EH	L	M	VL	Coarse
IN5015	CVD, TiN-TiCN	R47	•	•	•			•	C-2/C-6	P10-P30, K10-K30	M	M	M	M	Micro
IN5515	MT-CVD, TiCN, TiN				•				C-2/C-6	K10-K30 P15-P30	M	M	H	M	Micro
IN6510	MT-CVD, Al2O3	711, 714	•						C-2	K15-K20	L	H	EH	M	Fin.- Med.
IN6515	MT-CVD, Al2O3	722, 723	•		•				C-2/C-3/C-6	K15-K35, P20-P30	M	H	H	M	Micro
IN6530	MT-CVD, Al2O3	708, 731	•	•	•		•		C-1/C-5/C-6	P25-P45, M25-M40	EH	M-H	M-H	M-H	Coarse
IN6542	MT-CVD, Al2O3	732, 757, 762, 767	•	•		•	•		C-1/C-2	M20-M40, K20-K30	H	L	H	L	Medium
INDD15	MT-CVD + PVD		•		•				C-1/C-2	K20-K40	M	H	H	H	Medium
IN1030	PVD, TiCN	J05	•	•	•	•	•		C-1/C-2	M20-M40, K20-K30	H	L	H	L	Coarse
IN1040	PVD, TiCN	J47		•	•				C-5/C-6	P20-P40	H	H	H	H	Fin.- Med.
IN1510	PVD, TiCN-TiN	561	•			•			C-1/C-2/C-3	K20-K40	L	L	EH	L	Fin.- Med.
IN1515	PVD, TiCN-TiN	555H	•	•		•	•		C-1/C-2	M20-M40, K20-K30	H	L	M-H	L	Micro
IN1530	PVD, TiCN-TiN	555S, 581		•	•		•		C-1/C-5	M30, K25-K40	EH	M	M	M	Coarse
IN1540	PVD, TiCN-TiN	557, 563, 570, 585, 597		•	•				C-5/C-6	P20-P40	H	H	H	H	Fin.- Med.
IN2004	PVD, TiAlN	803	•		•			•	C-3/C-7	P15, K10	L	H	H	H	Micro
IN2005	PVD, TiAlN	804	•	•	•	•	•		C-2	M20-M40	H	M	H	M	Micro
IN2006	PVD, TiAlN			•	•		•	•	C7/C8	P05-P20 M10-M20	H	M	M	M	Micro
IN2010	PVD, TiAlN	811, B11	•						C-1/C-2	K10-K40	L	L-M	EH	L-M	Fin.- Med.
IN2510	PVD, TiAlN, TiN		•						C-1/C-2	K10-K40	L	L-M	EH	L-M	Fin.- Med.
IN2015	PVD, TiAlN	805H, 823	•	•	•		•		C-1/C-2	K10-K40	H	M	H	M	Micro
IN2030	PVD, TiAlN	805S, 831		•	•		•		C-1/C-5	K25-K40, M30-M40	EH	H	M	M-H	Coarse
IN2040	PVD, TiAlN	835, 847, B35			•				C-5/C-6	P20-P40	H	H-EH	H	H-EH	Fin.- Med.
IN2505	PVD, TiAlN, TiN		•	•	•	•	•	•	C1/C2	P15-P35 M10-M30 K10-K30	H	M	H	M	Micro
IN2540	PVD, TiAlN, TiN				•				C5/C6	P10-P40	H	H-EH	H	H-EH	Fin.- Med.
IN60C	None	406, 430			•			•	C-7/C-8	P05-P15	VL	EH	H	EH	Cermet
IN62C	None	NA			•			•	C-7/C-8	P10-P30	L	EH	H	EH	Cermet
IN70N	None	405				•			C-1/C-2	K10-K25	VL	VL	EH	EH	SiN
IN72N	None	NA		•	•				C-1/C-2	S01-S10	L	VL	EH	EH	SiN
IN80B	None	421		•	•				CBN	K01-K20	VL	EH	EH	EH	CBN
IN90D	None	411				•			PCD	PCD	VL	H	EH	VL	PCD

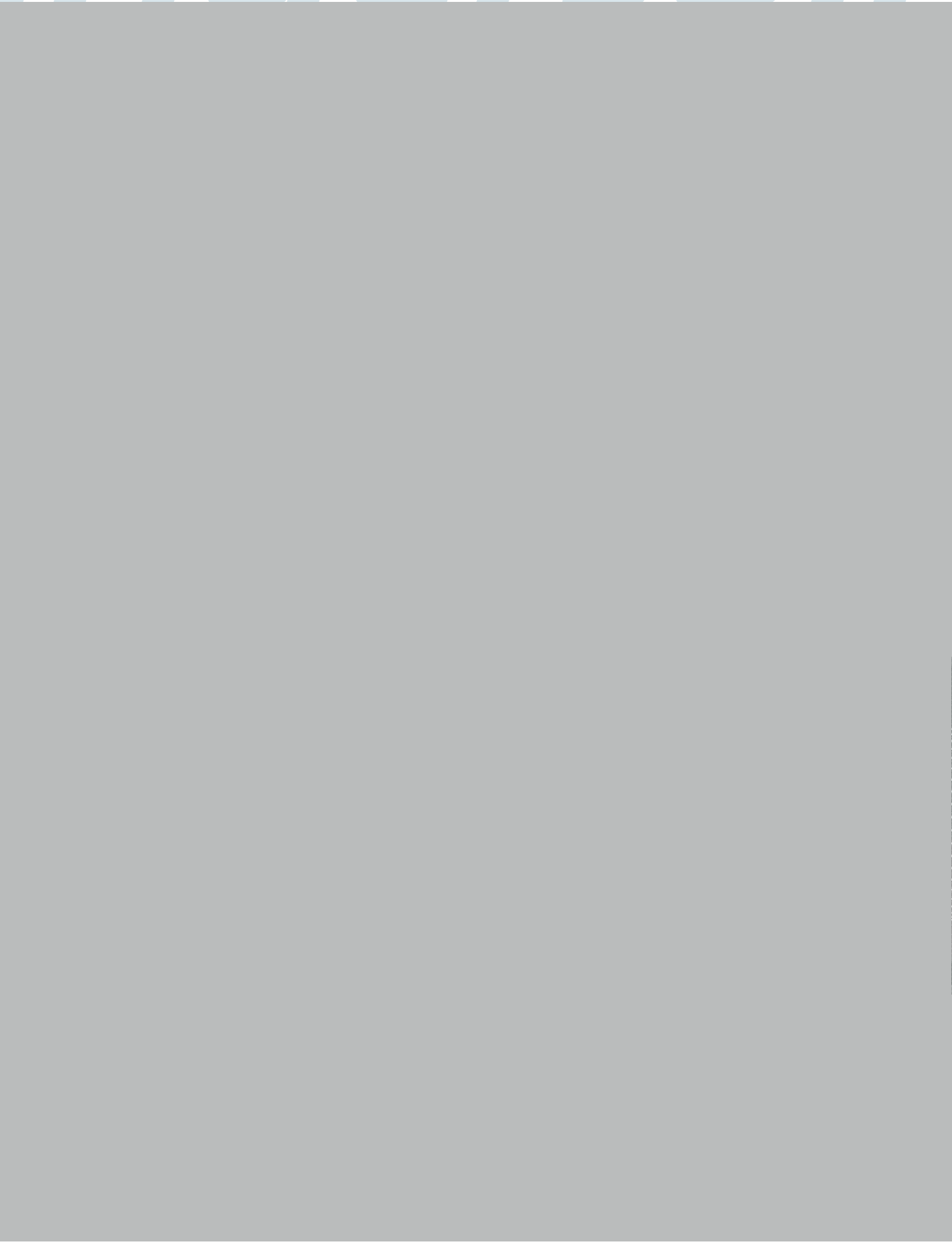

INSERT NOMENCLATURE ISO STANDARD INSERTS

A

P

K

T

INSERT SHAPE

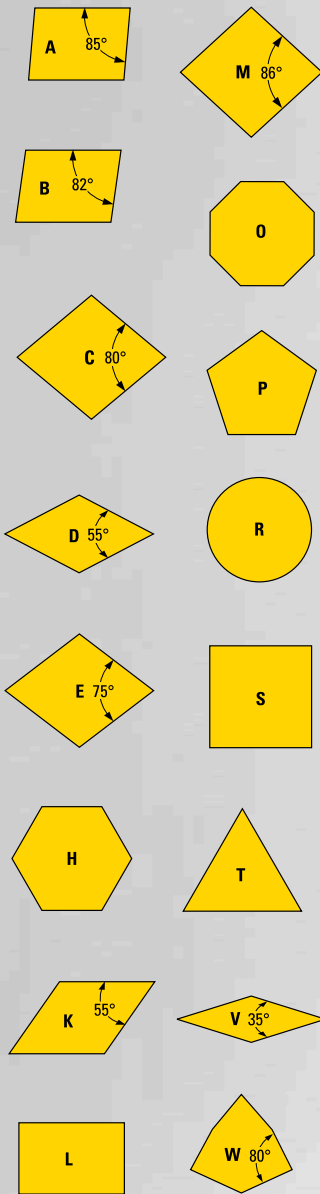

RELIEF ANGLE

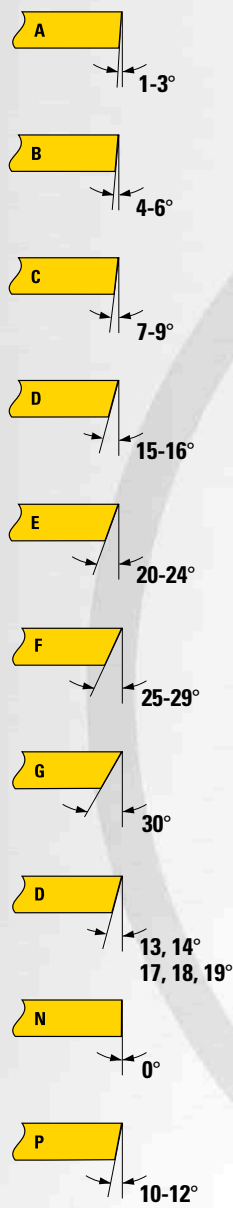

O = other angle

TOLERANCE

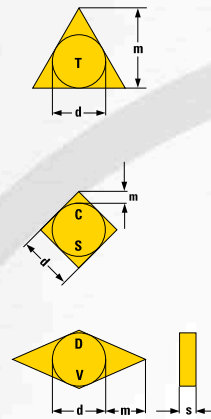

Allowable tolerance in mm:

	d	m	s
A	± 0,025	± 0,005	± 0,025
C	± 0,025	± 0,013	± 0,025
E	± 0,025	± 0,025	± 0,025
F	± 0,013	± 0,005	± 0,025
G	± 0,025	± 0,025	± 0,05-0,13
H	± 0,013	± 0,013	± 0,025
J'	± 0,05-0,15 ¹	± 0,005	± 0,025
K'	± 0,05-0,15 ¹	± 0,013	± 0,025
L'	± 0,05-0,15 ¹	± 0,013	± 0,025
M	± 0,05-0,15 ¹	± 0,08-0,20 ²	± 0,013
N	± 0,05-0,15 ¹	± 0,08-0,20 ²	± 0,025
U	± 0,05-0,25 ¹	± 0,13-0,38 ²	± 0,05-0,13

¹ Inserts with ground surfaces

² Dependant on insert size (see ISO standard 132)

INSERT TYPE

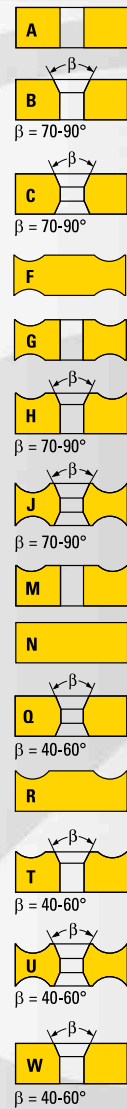

X
Special version
(description required)

08	03	04	F	R	-	P
CUTTING LENGTH	THICKNESS	RADIUS	HONE	HAND		MODIFIER
	<p>01 s = .062 T1 s = .078 02 s = .093 T2 s = .109 03 s = .125 T3 s = .156 04 s = .187 05 s = .219 06 s = .250 07 s = .312 09 s = .375</p>	<p>04 r = .015 08 r = .031 16 r = .062 24 r = .093 32 r = .125 48 r = .187 64 r = .250</p> <p>"00" for diameters converted from inch to mm. "M0" for diameters in metric dimensions.</p> <p>1 Bevel Angle A = 45° D = 60° E = 75° F = 85° P = 90° Z = other M = multiple</p> <p>2 Clearance Angle A = 3° B = 5° C = 7° D = 15° E = 20° F = 25° G = 30° J = 23° N = 0° P = 11° Z = other clearance angle</p>	<p>F sharp</p> <p>T K-Land</p>		<p>P = Polished W = Wiper PW = Polished Wiper VL = Variable Land FS = Flat Step Chip Breaker PS = Hooked Step Chip Breaker DM = Dimpled Chip Breaker DK = Double Wave Breaker with K-Land SK = Single Wave Breaker with K-Land DW = Double Wave Breaker, no K-Land SW = Single Wave Breaker, no K-Land HS = High Shear Geometry HR = "Rill"-Type Chip Breaker GB = Groove-Type Chip Breaker PH = Positive Hook RW = "Rills" and Wiper CR = Corner Rounding</p>	

GENERAL TECHNICAL INFORMATION

INSERTS

Insert Number	Corner Radius	New Grade	Cutter Series
ANHU160704FR-P	0.015 R	IN10K	1TJ1N, 1TJ1N (TOP-ON STYLE), 2TJ3N, 2TJ3N (SHELL MILL), TJ6N
ANHU160704R	0.015 R	IN2030	1TJ1N, 1TJ1N (TOP-ON STYLE), 2TJ3N, 2TJ3N (SHELL MILL), TJ6N
ANHU160708FR	0.031 R	IN2030	1TJ1N, 1TJ1N (TOP-ON STYLE), 2TJ3N, 2TJ3N (SHELL MILL), TJ6N
ANHU160708FR-P	0.031 R	IN10K	1TJ1N, 1TJ1N (TOP-ON STYLE), 2TJ3N, 2TJ3N (SHELL MILL), TJ6N
ANHU160708R	0.031 R	INDD15, IN2010, IN2030, IN2505, IN2540	1TJ1N, 1TJ1N (TOP-ON STYLE), 2TJ3N, 2TJ3N (SHELL MILL), TJ6N
ANHU160716R	0.062 R	IN2010, IN2030, IN2505, IN2540	1TJ1N, 1TJ1N (TOP-ON STYLE), 2TJ3N, 2TJ3N (SHELL MILL), TJ6N
ANHU1607ANR	0.015 R	IN2010, IN2030, IN2540	TN1N
AOCT060204FR-P	0.015 R	IN05S	12J1D, 12J1D (CHIP-SURFER STYLE), 12J1D (STRAIGHT SHANK), 12J1D (TOP-ON STYLE), 12P1D, 12N1D, 12M1D, 22J3D, 2J1D
AOCT120408FR-P	0.031 R	IN10K	12J1X, 12J1X (TOP-ON STYLE), 12R1X, 12V1X (TOP-ON STYLE), 22J3X, 22J3X (INNO-FIT STYLE), 22J3X (SHELL MILL), 22N3X, 2J1X, 2L1X
AOCT170508FR-P	0.031 R	K10	12J1G, 12J1G (TOP-ON STYLE), 22J3G, 2J1G
AOMT060202R	0.008 R	IN1030, IN2005, IN2030	12J1D, 12J1D (CHIP-SURFER STYLE), 12J1D (STRAIGHT SHANK), 12J1D (TOP-ON STYLE), 12P1D, 12N1D, 12M1D, 22J3D, 2J1D
AOMT060204R	0.015 R	IN2005, IN2030, IN2505	12J1D, 12J1D (CHIP-SURFER STYLE), 12J1D (STRAIGHT SHANK), 12J1D (TOP-ON STYLE), 12P1D, 12N1D, 12M1D, 22J3D, 2J1D
AOMT060208R	0.031 R	IN2005, IN2030, IN2505	12J1D, 12J1D (CHIP-SURFER STYLE), 12J1D (STRAIGHT SHANK), 12J1D (TOP-ON STYLE), 12P1D, 12N1D, 12M1D, 22J3D, 2J1D
AOMT060216R	0.062 R	IN2005, IN2030	12J1D, 12J1D (CHIP-SURFER STYLE), 12J1D (STRAIGHT SHANK), 12J1D (TOP-ON STYLE), 12P1D, 12N1D, 12M1D, 22J3D, 2J1D
AOMT120404R	0.015 R	IN1030, IN2005	12J1X, 12J1X (TOP-ON STYLE), 12R1X, 12V1X (TOP-ON STYLE), 22J3X, 22J3X (INNO-FIT STYLE), 22J3X (SHELL MILL), 22N3X, 2J1X, 2L1X
AOMT120408FR	0.031 R	IN2005, IN2030	12J1X, 12J1X (TOP-ON STYLE), 12R1X, 12V1X (TOP-ON STYLE), 22J3X, 22J3X (INNO-FIT STYLE), 22J3X (SHELL MILL), 22N3X, 2J1X, 2L1X
AOMT120408R	0.031 R	IN1030, IN2005, IN2010, IN2030, IN2040, IN2505	12J1X, 12J1X (TOP-ON STYLE), 12R1X, 12V1X (TOP-ON STYLE), 22J3X, 22J3X (INNO-FIT STYLE), 22J3X (SHELL MILL), 22N3X, 2J1X, 2L1X
AOMT120416R	0.062 R	IN1030, IN2005, IN2030, IN2510	12J1X, 12J1X (TOP-ON STYLE), 12R1X, 12V1X (TOP-ON STYLE), 22J3X, 22J3X (INNO-FIT STYLE), 22J3X (SHELL MILL), 22N3X, 2J1X, 2L1X
AOMT120424R	0.093 R	IN2005, IN2030	12J1X, 12J1X (TOP-ON STYLE), 12R1X, 12V1X (TOP-ON STYLE), 22J3X, 22J3X (INNO-FIT STYLE), 22J3X (SHELL MILL), 22N3X, 2J1X, 2L1X
AOMT120430FR	3.0 R	IN2005	12J1X, 12J1X (TOP-ON STYLE), 12R1X, 12V1X (TOP-ON STYLE), 22J3X, 22J3X (INNO-FIT STYLE), 22J3X (SHELL MILL), 22N3X, 2J1X, 2L1X
AOMT120432R	0.125 R	IN1030, IN2005, IN2010, IN2030, IN2040	12J1X, 12J1X (TOP-ON STYLE), 12R1X, 12V1X (TOP-ON STYLE), 22J3X, 22J3X (INNO-FIT STYLE), 22J3X (SHELL MILL), 22N3X, 2J1X, 2L1X
AOMT120440R	4.0 R	IN2505	12J1X, 12J1X (TOP-ON STYLE), 12R1X, 12V1X (TOP-ON STYLE), 22J3X, 22J3X (INNO-FIT STYLE), 22J3X (SHELL MILL), 22N3X, 2J1X, 2L1X
AOMT170504R	0.015 R	IN1030, IN2040	12J1G, 12J1G (TOP-ON STYLE), 22J3G, 2J1G
AOMT170508R	0.031 R	INDD15, IN1030, IN2005, IN2030, IN2040, IN2505, IN2510	12J1G, 12J1G (TOP-ON STYLE), 22J3G, 2J1G
AOMT170508R-HS	0.031 R	IN1030, IN2005, IN2010, IN2030, IN6530	12J1G, 12J1G (TOP-ON STYLE), 22J3G, 2J1G
AOMT170516R	0.062 R	IN1030, IN2005, IN2030, IN2510	12J1G, 12J1G (TOP-ON STYLE), 22J3G, 2J1G
AOMT170524R	0.093 R	IN1030, IN2005, IN2010	12J1G, 12J1G (TOP-ON STYLE), 22J3G, 2J1G
AOMT170532R	0.125 R	IN1030, IN2005, IN2040	12J1G, 12J1G (TOP-ON STYLE), 22J3G, 2J1G

Insert Number	Corner Radius	New Grade	Cutter Series
AOMT170540R-EM	0.156 R	IN1030	12J1G, 12J1G (TOP-ON STYLE), 2J1G
AOMT170548R	0.187 R	IN1030, IN2005, IN2040	12J1G, 12J1G (TOP-ON STYLE), 22J3G, 2J1G
AOMT170564R	0.250 R	IN1030, IN2005, IN2510, IN2540	12J1G, 12J1G (TOP-ON STYLE), 22J3G, 2J1G
AOMT180504FR-P	0.015 R	IN05S	12J1E (TOP-ON STYLE), 12J1E (V-FLANGE), 12J1E, 12J4E, 22J3E, 22J3E (INNO-FIT STYLE), 22J3E (Shell Mill), 2J1E, 2J4E, 2L1E
AOMT180504R-HS	0.015 R	IN2030	12J1E (TOP-ON STYLE), 12J1E (V-FLANGE), 12J1E, 12J4E, 22J3E, 22J3E (INNO-FIT STYLE), 22J3E (Shell Mill), 25J3H, 25J3H (Shell Mill), 2J1E, 2J4E, 2L1E
AOMT180508FR-P	0.031 R	IN30M	12J1E (TOP-ON STYLE), 12J1E (V-FLANGE), 12J1E, 12J4E, 22J3E, 22J3E (INNO-FIT STYLE), 22J3E (Shell Mill), 2J1E, 2J4E, 2L1E
AOMT180508R	0.031 R	IN1030, IN2005, IN2015, IN2030, IN2040	12J1E (TOP-ON STYLE), 12J1E (V-FLANGE), 12J1E, 12J4E, 22J3E, 22J3E (INNO-FIT STYLE), 22J3E (Shell Mill), 23J2G (END CAP STYLE), 23J2G ASSEMBLY, 23J6G, 25J3H, 25J3H (Shell Mill), 2J1E, 2J4E, 2L1E
AOMT180508R-HS	0.031 R	IN2005, IN2030, IN30M	12J1E (TOP-ON STYLE), 12J1E (V-FLANGE), 12J1E, 12J4E, 22J3E, 22J3E (INNO-FIT STYLE), 22J3E (Shell Mill), 25J3H, 25J3H (Shell Mill), 2J1E, 2J4E, 2L1E
AOMT180516FR-P	0.062 R	IN30M	12J1E (TOP-ON STYLE), 12J1E (V-FLANGE), 12J1E, 12J4E, 22J3E, 22J3E (INNO-FIT STYLE), 22J3E (Shell Mill), 2J1E, 2J4E, 2L1E
AOMT180516R	0.062 R	IN1030, IN2005, IN2015, IN2030, IN2040	12J1E (TOP-ON STYLE), 12J1E (V-FLANGE), 12J1E, 12J4E, 22J3E, 22J3E (INNO-FIT STYLE), 22J3E (Shell Mill), 23J2G (END CAP STYLE), 23J2G ASSEMBLY, 23J6G, 25J3H, 25J3H (Shell Mill), 2J1E, 2J4E, 2L1E
AOMT180516R-HS	0.062 R	IN2005	12J1E (TOP-ON STYLE), 12J1E (V-FLANGE), 12J1E, 12J4E, 22J3E, 22J3E (INNO-FIT STYLE), 22J3E (Shell Mill), 25J3E, 25J3H, 25J3H (Shell Mill), 2J1E, 2J4E, 2L1E
AOMT180524FR-P	0.093 R	IN30M	12J1E (TOP-ON STYLE), 12J1E (V-FLANGE), 12J1E, 12J4E, 22J3E, 22J3E (INNO-FIT STYLE), 22J3E (Shell Mill), 2J1E, 2J4E, 2L1E
AOMT180524R	0.093 R	IN1030, IN2005, IN2040	12J1E (TOP-ON STYLE), 12J1E (V-FLANGE), 12J1E, 12J4E, 22J3E, 22J3E (INNO-FIT STYLE), 22J3E (Shell Mill), 23J2G (END CAP STYLE), 23J2G ASSEMBLY, 23J6G, 25J3H, 25J3H (Shell Mill), 2J1E, 2J4E, 2L1E
AOMT180532FR-P	0.125 R	IN30M	12J1E (TOP-ON STYLE), 12J1E (V-FLANGE), 12J1E, 12J4E, 22J3E, 22J3E (INNO-FIT STYLE), 22J3E (Shell Mill), 2J1E, 2J4E, 2L1E
AOMT180532R	0.125 R	IN1030, IN2005, IN2015, IN2030, IN2040	12J1E (TOP-ON STYLE), 12J1E (V-FLANGE), 12J1E, 12J4E, 22J3E, 22J3E (INNO-FIT STYLE), 22J3E (Shell Mill), 23J2G (END CAP STYLE), 23J2G ASSEMBLY, 23J6G, 25J3H, 25J3H (Shell Mill), 2J1E, 2J4E, 2L1E
AOMT180548R	0.187 R	IN2005	12J1E, 12J4E, 22J3E (V-FLANGE), 2J1E, 2J4E
AOMT180564R	0.250 R	IN1030, IN2005, IN2040	12J1E, 12J4E, 22J3E (V-FLANGE), 2J1E, 2J4E
APKT160408L	0.031 R	IN1030, IN5015	15T, 12T
APKT160408R	0.031 R	IN1030, IN1540, IN2005, IN2015, IN2030, IN2040, IN40P, IN5015, IN6530	12J1B (TOP-ON STYLE), 12J1B (V-FLANGE), 12J1B, 12J4B, 12M1Q, 12N1Q, 12P1Q, 12N1B, 12R1B, 12S1Q, 12S1B, 12V1B (TOP-ON STYLE), 15T, 12T, 22J3Q (SHELL MILL STYLE), 22J5B, 22J3B, 2J1B, 2J4B, 2L1B
BEEW120308R-CR	0.031 Corner rounding	IN2030	15R1V, 15R1V (TOP-ON STYLE)
BEEW120310R-CR	1.0 Corner rounding	IN2030	15R1V, 15R1V (TOP-ON STYLE)
BEEW120316R-CR	0.062 Corner rounding	IN2030, IN2040	15R1V, 15R1V (TOP-ON STYLE)
BEEW120320R-CR	2.0 Corner rounding	IN2030	15R1V, 15R1V (TOP-ON STYLE)
BEEW120325R-CR	0.094 Corner rounding	IN2030	15R1V, 15R1V (TOP-ON STYLE)
BEEW120330R-CR	3.0 Corner rounding	IN2030	15R1V, 15R1V (TOP-ON STYLE)
BEEW120332R-CR	0.125 Corner rounding	IN2030, IN2040	15R1V, 15R1V (TOP-ON STYLE)

GENERAL TECHNICAL INFORMATION

INSERTS

Insert Number	Corner Radius	New Grade	Cutter Series
BEHW250304R	0.015 R	IN1540	15J1H, 15M1H, 15N1H
BEHW250304R-P	0.015 R	IN15K	15J1H, 15M1H, 15N1H
BEHW250308R	0.031 R	IN1540	15J1H, 15M1H, 15N1H
BEHW250308R-P	0.031 R	IN15K	15J1H, 15M1H, 15N1H
BEHW250316R	0.062 R	IN1540	15J1H, 15M1H, 15N1H
BEHW250316R-P	0.062 R	IN15K	15J1H, 15M1H, 15N1H
BOCT09T304FR-P	0.015 R	IN10K	12J1P, 12J1P (TOP-ON STYLE), 22J3P, 2J1P
BOCT09T308FR-P	0.031 R	IN10K	12J1P, 12J1P (TOP-ON STYLE), 22J3P, 2J1P
BOCT130404FR-P	0.015 R	IN10K	12J1R
BOMT09T304R	0.015 R	IN2030, IN2505	12J1P, 12J1P (TOP-ON STYLE), 22J3P, 2J1P
BOMT09T308R	0.031 R	IN2030, IN2505	12J1P, 12J1P (TOP-ON STYLE), 22J3P, 2J1P
BOMT09T316R	0.062 R	IN2030, IN2505	12J1P, 12J1P (TOP-ON STYLE), 22J3P, 2J1P
BOMT130404R	0.015 R	IN2030, IN2505	12J1R
BOMT130408R	0.031 R	IN2030, IN2505	12J1R
BOMT130416R	0.062 R	IN2030, IN2505	12J1R
BOMT130420R	0.078 R	IN2030, IN2505	12J1R
BOMT130424R	0.093 R	IN2030, IN2505	12J1R
BOMT130431R	0.125 R	IN2030, IN2505	12J1R
BOMT130440R	0.156 R	IN2030, IN2505	12J1R
CNHU060310N	1.0 R	IN1030, IN2005, IN2006, IN2040, IN3005	15V, 15V (TOP-ON STYLE)
CNHU110420N	2.0 R	IN1030, IN2005, IN2006, IN2040	15V, 15V (TOP-ON STYLE), 5V6G (SHELL MILL)
DGE314R001	0.031 R	IN2030	1SJ1F, 1SJ1F (TOP-ON STYLE), 2SJ3F, 2SJ3F (Shell Mill), SJ6F, SJ5F
DGE314R002	0.062 R	IN2030	1SJ1F, 1SJ1F (TOP-ON STYLE), 2SJ3F, 2SJ3F (Shell Mill), SJ6F, SJ5F
DGE314R004	0.125 R	IN2030	1SJ1F, 1SJ1F (TOP-ON STYLE), 2SJ3F, 2SJ3F (Shell Mill), SJ6F, SJ5F
DGE324R001	0.031 R	IN2030	2SJ3J (Shell Mill), SJ2J, SJ5J, SJ6J
DGE324R002	0.062 R	IN2030	2SJ3J (Shell Mill), SJ2J, SJ5J, SJ6J
DGE324R004	0.125 R	IN2030	SJ2J, SJ5J, SJ6J
DGE324R045	0.010 R	IN2030	SN6J, SN2J
DGM212R100	0.015 R	IN2005, IN2015, IN2030	1SJ1Y, 1SJ1Y (CHIP SURFER STYLE), 1SJ1Y (TOP-ON STYLE), 2SJ3Y, SJ_Y
DGM212R101	0.031 R	IN2005, IN2015, IN2030	1SJ1Y, 1SJ1Y (CHIP SURFER STYLE), 1SJ1Y (TOP-ON STYLE), 2SJ3Y, SJ_Y
DGM212R103	0.062 R	IN2005, IN2015, IN2030	1SJ1Y, 1SJ1Y (CHIP SURFER STYLE), 1SJ1Y (TOP-ON STYLE), 2SJ3Y, SJ_Y
DGM314R001	0.031 R	IN2005, IN2015, IN2030, IN2040, IN6515	1BW / 2BW, 1SJ1F, 1SJ1F (TOP-ON STYLE), 2SJ3F, 2SJ3F (Shell Mill), SJ6F, SJ5F
DGM314R002	0.062 R	IN2005, IN2015, IN2030, IN2040, IN6515	1SJ1F, 1SJ1F (TOP-ON STYLE), 2SJ3F, 2SJ3F (Shell Mill), SJ6F, SJ5F
DGM314R003	0.093 R	IN2005	1SJ1F, 1SJ1F (TOP-ON STYLE), 2SJ3F, 2SJ3F (Shell Mill), SJ6F, SJ5F
DGM314R004	0.125 R	IN2005, IN2015, IN2030, IN2040, IN6515	1SJ1F, 1SJ1F (TOP-ON STYLE), 2SJ3F, 2SJ3F (Shell Mill), SJ6F, SJ5F
DGM324R001	0.031 R	IN2005, IN2015, IN2030, IN2040, IN6515	1BW / 2BW, 2SJ3J (Shell Mill), SJ2J, SJ5J, SJ6J

Insert Number	Corner Radius	New Grade	Cutter Series
DGM324R002	0.062 R	IN2005, IN2015, IN2030, IN2040, IN6515	2SJ3J (Shell Mill), SJ2J, SJ5J, SJ6J
DGM324R003	0.093 R	IN2005	2SJ3J (Shell Mill), SJ2J, SJ5J, SJ6J
DGM324R004	0.125 R	IN2005, IN2015, IN2030, IN2040, IN6515	SJ2J, SJ5J, SJ6J
DGM324R045	0.010 R	IN2005, IN2015, IN2030, IN2040, IN6515	SN6J, SN2J
DGM324R201	0.031 R	IN2005, IN2015, IN2030, IN2040, IN6515	2SJ3J (Shell Mill), SJ2J, SJ5J, SJ6J
DGM324R202	0.062 R	IN2005, IN2015, IN2030, IN2040, IN6515	2SJ3J (Shell Mill), SJ2J, SJ5J, SJ6J
DNM434L201	0.031 R	IN2005	2SJ1N
DNM434L202	0.062 R	IN2005, IN2030	2SJ1N
DNM434R201	0.031 R	IN2005, IN2015, IN2030, IN2040	2SJ1N, SJ2N
DNM434R202	0.062 R	IN2005, IN2030, IN2040	2SJ1N, SJ2N
DNM434R203	0.093 R	IN2005	2SJ1N, SJ2N
DNM434R204	0.125 R	IN2005	2SJ1N, SJ2N
DNM434R245	-	IN2005, IN2015, IN2030	SN2N
DPM314-001	0.031 R	IN1530, IN2005, IN2015	3SJ6 (AXIAL DRIVE), 3SJ6 (RADIAL DRIVE)
DPM314-002	0.062 R	IN1530, IN2005, IN2015	3SJ6 (AXIAL DRIVE), 3SJ6 (RADIAL DRIVE)
DPM314-003	0.094 R	IN2005	3SJ6 (AXIAL DRIVE), 3SJ6 (RADIAL DRIVE)
DPM314-004	0.125 R	IN1530, IN2005, IN2015	3SJ6 (AXIAL DRIVE), 3SJ6 (RADIAL DRIVE)
DPM324-001	0.031 R	IN1530, IN2005, IN2015	3SJ6 (AXIAL DRIVE), 3SJ6 (RADIAL DRIVE)
DPM324-002	0.062 R	IN2005, IN2015	3SJ6 (AXIAL DRIVE), 3SJ6 (RADIAL DRIVE)
DPM324-003	0.094 R	IN1530, IN2005	3SJ6 (AXIAL DRIVE), 3SJ6 (RADIAL DRIVE)
DPM324-004	0.125 R	IN1530, IN2005, IN2015	3SJ6 (AXIAL DRIVE), 3SJ6 (RADIAL DRIVE)
DPM324L050	0.062 R	IN1530, IN2005	SHU
DPM324L051	0.062 R	IN1530, IN2005, IN2015, IN2030	SP6H, SP6N
DPM324L101	0.125 R	IN1530, IN2005, IN2030	SP6H, SP6N
DPM324R001	0.031 R	IN1530, IN2005, IN2015	2SJ1H, 2SJ1L (SHELL MILL), SJ6H
DPM324R002	0.062 R	IN1530, IN2005	2SJ1H, 2SJ1L (SHELL MILL), SJ6H
DPM424-001	0.031 R	IN2005, IN2015, IN2040	3SJ6 (AXIAL DRIVE), 3SJ6 (RADIAL DRIVE)
DPM424-002	0.062 R	IN2005, IN2015, IN2040	3SJ6 (AXIAL DRIVE), 3SJ6 (RADIAL DRIVE)
DPM424-003	0.094 R	IN2005, IN2015, IN2040	3SJ6 (AXIAL DRIVE), 3SJ6 (RADIAL DRIVE)

GENERAL TECHNICAL INFORMATION

INSERTS

Insert Number	Corner Radius	New Grade	Cutter Series
DPM424-004	0.125 R	IN2005, IN2015, IN2040	3SJ6 (AXIAL DRIVE), 3SJ6 (RADIAL DRIVE)
DPM424R001	0.031 R	IN2005, IN2015, IN2040	2SJ1H, 2SJ1L (SHELL MILL)
DPM434L050	0.062 R	IN1530, IN2005	SHU
DPM434L051	0.062 R	IN1530, IN2005, IN2015, IN2030	SP6H, SP6N
DPM434L101	0.200 R	IN1530, IN2005, IN2030	SP6H, SP6N
DPM434R001	0.031 R	IN1530, IN2005, IN2015, IN2030, IN2040	SJ2N, SJ6N
DPM434R002	0.062 R	IN2005, IN2015, IN2040, IN6515, IN1530	SJ2N, SJ6N
DPM434R003	0.093 R	IN1530	SJ2N, SJ6N
DPM434R004	0.125 R	IN1530, IN2005	SJ2N, SJ6N
DPM434R045	-	IN1530, IN2005, IN2015, IN2030, IN2040	SN2N, SN6N
DPM435R045	0.010 R	IN2005, IN2015	SN2N, SN6N
DPM436R001	0.031 R	IN1530, IN2005, IN2015, IN2030, IN2040, IN6515, IN6530	SJ2R
DPM436R002	0.062 R	IN1530, IN2005, IN2015, IN2030, IN2040, IN6515, IN6530	SJ2R
DPM436R003	0.093 R	IN1530, IN2005	SJ2R
DPM436R004	0.125 R	IN1530, IN2005, IN2015, IN2030, IN2040, IN6515, IN6530	SJ2R
DPM436R045	0.010 R	IN1530, IN2005, IN2015, IN2030, IN2040	SN2R
DTM324R001	0.031 R	IN1530, IN2005, IN2015	2SJ1H, 2SJ1L (SHELL MILL)
FEEW250340R-CR	4.0 Corner rounding	IN2030	15R4H, 15R4H (TOP-ON STYLE)
FEEW250348R-CR	0.187 Corner rounding	IN2030	15R4H, 15R4H (TOP-ON STYLE)
FEEW250350R-CR	5.0 Corner rounding	IN2030	15R4H, 15R4H (TOP-ON STYLE)
FEEW250360R-CR	6.0 Corner rounding	IN2030	15R4H, 15R4H (TOP-ON STYLE)
FEEW250364R-CR	0.250 Corner rounding	IN2030	15R4H, 15R4H (TOP-ON STYLE)
GEKT12T3AFTR-WC	0.047 R	IN1030, IN2040, IN2510	15N1H, 5N2H
GOMT060230R	Chamfer 30 deg.	IN1505	MHK SLIP FIT CHAMFER SHANKS
GOMT060245R	Chamfer	IN1505	MHK SLIP FIT CHAMFER SHANKS
GOMT060260R	Chamfer 60 deg.	IN1505	MHK SLIP FIT CHAMFER SHANKS
GOMT080330R	Chamfer 30 deg.	IN1505	MHK SLIP FIT CHAMFER SHANKS

Insert Number	Corner Radius	New Grade	Cutter Series
GOMT080345R	Chamfer	IN1505	MHK SLIP FIT CHAMFER SHANKS
GOMT080360R	Chamfer 60 deg.	IN1505	MHK SLIP FIT CHAMFER SHANKS
GPHG091208R01	0.031 R	IN2005	12W5 (Solid Carbide), 12W9, 12W9 (TOP-ON STYLE)
GPHG121708R01	0.031 R	IN2005	12W5 (Solid Carbide), 12W9, 12W9 (TOP-ON STYLE)
GPHG121716R01	0.062 R	IN2005	12W5 (Solid Carbide), 12W9, 12W9 (TOP-ON STYLE)
GPHG121732R01	0.125 R	IN2005	12W5 (Solid Carbide), 12W9, 12W9 (TOP-ON STYLE)
GPHG152208R01	0.031 R	IN2005	12W5 (Solid Carbide), 12W9, 12W9 (TOP-ON STYLE)
GPHG152216R01	0.062 R	IN2005	12W5 (Solid Carbide), 12W9, 12W9 (TOP-ON STYLE)
GPHG152232R01	0.125 R	IN2005	12W5 (Solid Carbide), 12W9, 12W9 (TOP-ON STYLE)
GPHG192508R01	0.031 R	IN2005	12W5 (Solid Carbide), 12W9, 12W9 (TOP-ON STYLE)
GPHG192516R01	0.062 R	IN2005	12W5 (Solid Carbide), 12W9, 12W9 (TOP-ON STYLE)
GPHG192532R01	0.125 R	IN2005	12W5 (Solid Carbide), 12W9, 12W9 (TOP-ON STYLE)
GPHG252608R01	0.031 R	IN2005	12W9, 12W9 (TOP-ON STYLE)
GPHG252616R01	0.062 R	IN2005	12W9, 12W9 (TOP-ON STYLE)
GPHG252632R01	0.125 R	IN2005	12W9, 12W9 (TOP-ON STYLE)
KOMT050104R	Chamfer	IN2005	YC TAP DRILL/CHAMFER BODIES
NCE324-100	0.031 R	IN70N	5VK6V, VK5V (HI DENSITY), VK6V (COARSE-DENSITY), VK6V (MEDIUM-DENSITY)
NCE324R107	0.031 R	IN70N	VL6V
NCET250400R	0.500 R	IN2005, IN2030	1BW (TOP-ON STYLE), 1BW / 2BW
NDET380700R	0.750 R	IN2005	1BW / 2BW
NDET500800R	1.000 R	IN2005	1BW, 1BW / 2BW
NJE324-100-P	0.031 R	IN15K	5VK6V, VK6V (COARSE-DENSITY), VK6V (MEDIUM-DENSITY)
NKET120200R	0.250 R	IN2005, IN2030	1BW (CHIP-SURFER STYLE), 1BW (TOP-ON STYLE), 1BW / 2BW
NKET180300R	0.375 R	IN2005	1BW (CHIP-SURFER STYLE), 1BW (TOP-ON STYLE), 1BW / 2BW
NNE324-100	0.031 R	IN1530, IN2010, IN2015, IN2030, IN2040, IN6515	5VK6V, VHU, VK5V (HI DENSITY), VK6V (COARSE-DENSITY), VK6V (MEDIUM-DENSITY)
NNE324-102	0.062 R	IN1530, IN2015, IN2030, IN2040, IN6515	5VK6V, VHU, VK5V (HI DENSITY), VK6V (COARSE-DENSITY), VK6V (MEDIUM-DENSITY)
NNE324-104	0.031 Chamfer	IN1530, IN2010, IN2015, IN2040, IN6515	5VK6V, VK5V (HI DENSITY), VK6V (COARSE-DENSITY), VK6V (MEDIUM-DENSITY)
NNE324-108	0.031 R	IN2030, IN2040, IN6515	3VL5V (AXIAL DRIVE), 3VL5V (RADIAL DRIVE)
NNE324-110	-	IN2015, IN2030, IN2040, IN6515	VM6V
NNE324-125	0.125 R	IN2010, IN2030	5VK6V, VHU, VK5V (HI DENSITY), VK6V (COARSE-DENSITY), VK6V (MEDIUM-DENSITY)
NNE324L109	0.031 R	IN2005, IN2015, IN2030, IN2040, IN6515	5VK6V, VK5V (HI DENSITY), VK6V (COARSE-DENSITY), VK6V (MEDIUM-DENSITY)
NNE324R107	0.031 R	IN2005, IN2015, IN2030, IN2030, IN2040, IN6515	VL6V
NNE324R109	0.031 R	IN2005, IN2010, IN2015, IN2030, IN2040, IN6515	5VK6V, VK5V (HI DENSITY), VK6V (COARSE-DENSITY), VK6V (MEDIUM-DENSITY)
NNE425-030	0.005 R	IN2005, IN6510	VM2N
NNET310500R	0.625 R	IN2005	1BW / 2BW
NPHG090300R	0.187 R	IN2005, IN2006	12W5 (Solid Carbide), 12W9, 12W9 (TOP-ON STYLE)
NPHG120400R	0.250 R	IN05S, IN2005, IN2006	12W5 (Solid Carbide), 12W9, 12W9 (TOP-ON STYLE)

GENERAL TECHNICAL INFORMATION

INSERTS

Insert Number	Corner Radius	New Grade	Cutter Series
NPHG150400R	0.312 R	IN2005, IN2006	12W5 (Solid Carbide), 12W9, 12W9 (TOP-ON STYLE)
NPHG190400R	0.375 R	IN05S, IN2005, IN2006	12W5 (Solid Carbide), 12W9, 12W9 (TOP-ON STYLE)
NPHG250600R	0.500 R	IN05S, IN2005, IN2006	12W9, 12W9 (TOP-ON STYLE)
NPHG310700R	0.625 R	IN2005	12W9
OELB060416FN	0.060 R	IN2030, IN2040	5N6K
OELB060416N	0.060 R	IN1530, IN1540, IN2030	5N6K
OELH060416N	0.060 R	IN1530, IN2005, IN2030	5N6K
OELH060416-P	0.060 R	IN30M	5N6K
OFCT05T3AFFN-P	0.024 R	K10, IN30M	5N6H
OFCT05T3TN	0.024 R	IN1030, IN2005, IN2040	5N6H
OFCT0705AFFN-P	0.031 R	IN30M	5N6L
OFCT0705AFFR-W	0.031 R	IN1030	5N6L
OFMT05T3AFN-HR	0.024 R	IN1030, IN2005, IN2040, IN30M	5N6H
OFMT0705AFR-HR	0.031 R	IN2030, IN2040, IN30M	5N6L
OFMT0705AFTN	0.031 R	IN1030, IN2005, IN2015	5N6L
OFMW0705AFTN	0.031 R		5N6L
ONCU0505ANEN	0.031 R	, IN2010	ON5H ON6H
ONCU0505ANFN-P	0.031 R	IN10K	ON5H ON6H
ONCU0505ANTN-HR	0.031 R	IN2005, IN2030, IN2505	ON5H ON6H
ONCU0505ANTN-W	0.031 R	IN2505	ON5H ON6H
ONCU090612FN-P	0.047 R	IN10K	OP1N, OP6N
ONCU090612TN-HR	0.047 R	IN2005, IN2030, IN2040	OP1N, OP6N
ONCU090612TN-W	0.047 R	IN2505	OP1N, OP6N
ONCU0906ANFN-WE	0.031 Faceted	IN2004, IN2510, IN6515, IN6515	OP1N, OP6N
OPEN050608TR	0.031 R	IN72N	5J2H
PNCQ0804GNTN	0.030 R	IN2005, IN2030	DM6G, DM5G
PNCQ0804ZNTN	0.180 R	IN2005, IN2030	1DP1G, 1DP1G (TOP ON STYLE), DP5G
PNCT0804ZNN-HR	0.180 R	IN2030, IN2505	1DP1G, 1DP1G (TOP ON STYLE), DP5G
PNCU0805GNFR-HS	0.030 R	IN2030, IN2505	DM6G, DM5G
PNCU0805GNFR-P	0.030 R	IN05S	DM6G, DM5G
PNCU0805GNR	0.030 R	IN70N	DM6G, DM5G
PNCU0805GNTR	0.030 R	INDD15, IN1030, IN2005, IN2015, IN2030	DM6G, DM5G
PNCU0805GNTR-W	0.030 R	INDD15, IN2005, IN2030, IN2505	DM6G, DM5G
PNCU1708GNTR	0.060 R	INDD15, INDD15, IN2005, IN2005, IN2030, IN2030, IN2040, IN2040	DM2Q, DM6Q, DM5Q

Insert Number	Corner Radius	New Grade	Cutter Series
PNCU1708GNTR	0.060 R	INDD15, INDD15, IN2005, IN2005, IN2030, IN2030, IN2040, IN2040	DM2Q, DM6Q, DM5Q
RCHX120400FN-P	0.250 R	IN10K	15B4H, 15B4J (TOP-ON STYLE), 5W6J
RCKX120400TN-M	0.250 R	IN2005, IN2030, IN2505, IN5515	15B4H, 15B4J (TOP-ON STYLE), 5W6J
RCLB120500TN-VL	0.250 R	IN2005, IN2040, IN6530	15B4H, 15B4J (TOP-ON STYLE), 5W6J
RCLB19T600TN-VL	0.375 R	IN2005, IN2040, IN6530	15B4M (Toroid TOP-ON STYLE), 5W6N
RCLT1204M0N-CC1	6.0 R	IN2005, IN2015, IN2030	15E1H, 15E1K (TOP-ON STYLE), 5E6K / 5E6H
RCLT1204M0N-CC2	6.0 R	IN2005, IN2015, IN2030	15E1H, 15E1K (TOP-ON STYLE), 5E6K / 5E6H
RCLT1204M0N-CP	6.0 R	IN05S	15E1H, 15E1K (TOP-ON STYLE), 5E6K / 5E6H
RCLT1204M0TN-PH2	6.0 R	IN2005, IN2015, IN2030, IN2040	15E1H, 15E1K (TOP-ON STYLE), 5E6K / 5E6H
RCLT1606M0N-CC	8.0 R	IN2005, IN2015, IN2030	15E1K (TOP-ON STYLE), 5E6K / 5E6H
RCLT1606M0N-CC1	8.0 R	IN2005, IN2015, IN2030	15E1K (TOP-ON STYLE), 5E6K / 5E6H
RCLT1606M0N-CC2	8.0 R	IN2005, IN2030	15E1K (TOP-ON STYLE), 5E6K / 5E6H
RCLT1606M0N-CP	8.0 R	IN05S	15E1K (TOP-ON STYLE), 5E6K / 5E6H
RCLT1606M0TN-PH	8.0 R	IN2005, IN2015, IN2030	15E1K (TOP-ON STYLE), 5E6K / 5E6H
RCLT1606M0TN-PH2	8.0 R	IN2005, IN2015, IN2040	15E1K (TOP-ON STYLE), 5E6K / 5E6H
RCLT190600N-HR	0.375 R	IN2005, IN2030, IN2040	15B4M (Toroid TOP-ON STYLE), 5W6N
RFMT1404M0N-F	0.275 R	IN1030, IN2040	5N6H
RHHT1003M0FN-P	5.0 R	IN05S	15B1 (TOP-ON STYLE), 5W7
RHHT1204M0FN-P	6.0 R	IN05S	15B1 (TOP-ON STYLE), 5W7
RHHW0602M0TN	3.0 R	IN2004, IN2005, IN2006	15B1 (TOP-ON STYLE)
RHHW0802M0TN	4.0 R	IN2004, IN2005, IN2015	15B1 (TOP-ON STYLE)
RHHW1003M0TN	5.0 R	IN2004, IN2005, IN2006, IN2015, IN2040	15B1 (TOP-ON STYLE), 5W7
RHHW1204M0TN	6.0 R	IN2004, IN2005, IN2006, IN2015, IN2040	15B1 (TOP-ON STYLE), 5W7
RHHW1605M0TN	8.0 R	IN2004, IN2005, IN2015, IN2040	15B1 (TOP-ON STYLE), 5W7
RHKW1003M0TN	5.0 R	IN2005, IN2015, IN2040	15B1 (TOP-ON STYLE), 5W7
RHKW1204M0TN	6.0 R	IN2004, IN2005, IN2015, IN2040	15B1 (TOP-ON STYLE), 5W7
RHKW1605M0TN	8.0 R	IN2004, IN2005, IN2015, IN2030, IN2040	15B1 (TOP-ON STYLE), 5W7
RHKW2006M0TN	10.0 R	IN2015, IN2030, IN2040	5W7
RNGX45CH	0.250 R	IN72N	DW*H

GENERAL TECHNICAL INFORMATION

INSERTS

Insert Number	Corner Radius	New Grade	Cutter Series
RNLM250600TN	0.500 R	IN1530, IN1540, IN2030, IN40P, IN6530	5W6
RNMA250600N	0.500 R	IN1540, IN40P	5W6
RPCW120400N	0.250 R	IN1530, IN2030	15B1H, 5W6
RPGX43CH	0.250 R	IN72N	1DB1H
RPLB190500FN	0.375 R	IN2030	5W6
RPLB190500TN	0.375 R	IN1530, IN2030, IN6530	5W6
RPLB250700FN	0.500 R	IN2030, IN2040	5W6S
RPLB250700TN-VL	0.500 R	IN2030, IN2040, IN6530	5W6S
RPLB250700TN-VL1	0.500 R	IN2030, IN2040	15W4S (Toroid), 5W6 (Toroid)
RPLH190500TN	0.375 R	IN1530, IN1540, IN2030, IN2040, IN40P, IN6530	5W6
RPLT090400N	0.187 R	IN1530, IN1540, IN2030, IN6530	15B1F
RPLT120400TN	0.250 R	IN1530, IN1540, IN2030, IN2040, IN40P, IN6530	15B1H, 5W6
RPLW120400FN	0.250 R	IN2030	15B1H, 5W6
RPLW120400TN	0.250 R	IN1530, IN2030, IN6530	15B1H, 5W6
SCLT050204N	0.016 R	IN2010	INDEXABLE DRILLS 5
SCLT050204N-PH	0.015 R	IN1030, IN2005, IN6520	INDEXABLE DRILLS 5
SDCT080305FN-P	0.020 R	IN30M	15J1E, 15N1E (TOP-ON STYLE), 15N1E, 15P1E, 25J3E, 25J3E (INNO-FIT), 35J6E, 5J1E
SDE-31-001	0.006 Chamfer 20 deg.	IN1030, IN30M	38L5 (AXIAL DRIVE), 38L5 (RADIAL DRIVE)
SDE-31-002	0.006 Chamfer 20 deg.	IN1030, IN2040	38L5 (AXIAL DRIVE), 38L5 (RADIAL DRIVE)
SDE-42-001	0.012 Chamfer 17 deg.	IN1030, IN15K	38L5 (AXIAL DRIVE), 38L5 (RADIAL DRIVE)
SDE-42-002	0.012 Chamfer 17 deg.	IN1030	38L5 (AXIAL DRIVE), 38L5 (RADIAL DRIVE)
SDE-42-003	0.012 Chamfer 17 deg.	IN1030	38L5 (AXIAL DRIVE), 38L5 (RADIAL DRIVE)
SDGT07T308-HP	0.030 R	IN10K	INDEXABLE DRILLS 2
SDGT140512-HP	0.047 R	IN10K	INDEXABLE DRILLS 2
SDLT07T308N-PH	0.030 R	IN2005	15C
SDLT07T308N-PS	0.030 R	IN1030, IN2005, IN6515	15C
SDMT080305N	0.020 R	IN1030, IN2005, IN2015, IN2030, IN2040	15J1E, 15N1E (TOP-ON STYLE), 15N1E, 15P1E, 25J3E, 25J3E (INNO-FIT), 35J6E, 5J1E
SDMT080308N	0.031 R	IN1530	15J1E, 15N1E (TOP-ON STYLE), 15N1E, 15P1E, 25J3E, 25J3E (INNO-FIT), 35J6E, 5J1E
SDMT080316N	0.062 R	IN1530	15J1E, 15N1E (TOP-ON STYLE), 15N1E, 15P1E, 25J3E, 25J3E (INNO-FIT), 35J6E, 5J1E
SDMT120608R	0.031 R	IN1030, IN2005, IN2015, IN5015	25J3H, 25J3H (Shell Mill), 5J1H
SDMT120608R-HS	0.031 R	IN2005, IN2030	25J3H, 25J3H (Shell Mill), 5J1H
SDMW080305TN	0.020 R	IN1030, IN2005, IN2015, IN2030	15J1E, 15N1E (TOP-ON STYLE), 15N1E, 15P1E, 25J3E, 25J3E (INNO-FIT), 35J6E, 5J1E

Insert Number	Corner Radius	New Grade	Cutter Series
SDMW080305TN-W	0.020 R	IN2005, IN2015	15J1E, 5J1E
SDMW080308TN	0.031 R	IN1530	15J1E, 15N1E (TOP-ON STYLE), 15N1E, 15P1E, 25J3E, 25J3E (INNO-FIT), 35J6E, 5J1E
SECT09T3AFFN-P	0.015 R	IN30M	15N1F_R00, 5N6F
SEKT09T3AFN	0.015 R	IN1030, IN2005, IN2030, IN2040	15N1F_R00, 5N6F
SEKT12T3AFTN-M	0.043 R	IN1030, IN2005, IN2510, IN2540, IN40P	15N1H, 5N2H
SELW100403N	0.010 R	IN1530	FAK (QUAD INSERT)
SHEH1504AEN-P	0.020 R	IN15K	5N6R
SHEH1504AETN1-P	0.020 R	IN2005	5N6R
SHET110502FR-P	0.008 R	IN15K	15U1G, 15U1G (TOP-ON STYLE), 5H6G
SHET110505FR-P	0.020 R	IN15K	15U1G, 15U1G (TOP-ON STYLE), 5H6G
SHET110508FR-P	0.031 R	IN15K	15U1G, 15U1G (TOP-ON STYLE), 5H6G
SHET110516FR-P	0.062 R	IN15K	15U1G, 15U1G (TOP-ON STYLE), 5H6G
SHET110524FN-P	0.093 R	IN15K	15U1G, 15U1G (TOP-ON STYLE), 5H6G
SHET110532FN-P	0.125 R	IN15K	15U1G, 15U1G (TOP-ON STYLE), 5H6G
SHET1504AJTN	0.031 R	IN1530, IN2005, IN2010, IN2040	5N6R
SHEW1504AJTN	0.031 R	IN2040, IN2015	5N6R
SHLT090308N-HR	0.031 R	IN1030, IN2005, IN30M	15L1G, 15M1G, 15N1F, 15N1G, 15W7V, 25W1V, 25J3F, 25J3G
SHLT090408N-FS	0.031 R	IN1030, IN2005, IN6515	15S, 15T, 12T, DHU (TOP-ON STYLE)
SHLT090416N-FS	0.062 R	IN1530	15S, DHU (TOP-ON STYLE)
SHLT110408N-FS	0.031 R	IN1030, IN2005, IN6515	15C, 15S, DHU (TOP-ON STYLE)
SHLT110408N-PH	0.030 R	IN2005	15C, 15S
SHLT110408TN-HR	0.031 R	IN1030, IN2005, IN30M, IN40P, IN6530	15C, 15L1G, 15M1G, 15N1F, 15N1G, 15S, 15W7V, 25W1V, 23J2G (END CAP STYLE), 23J2G ASSEMBLY, 23J2G BODY, 23J6G, 25J3F, 25J3G, 25J3G, 25J3J (SHELL MILL), DHU (TOP-ON STYLE)
SHLT110416N-FS	0.062 R	IN1030	15C, 15S, DHU (TOP-ON STYLE)
SHLT140508N-FS	0.031 R	IN1030, IN2005, IN6515	15C, 15S, DHU
SHLT140508N-PH	0.030 R	IN2005	15C, 15S
SHLT140508TN-HR	0.031 R	IN1030, IN2005, IN30M, IN40P, IN6530	15C, 15S, 25J3G, 25J3J (SHELL MILL), 25J3J (END CAP STYLE), 25J3J BODY, 25J3J END CAP, DHU
SHLT140516N-FS	0.062 R	IN1030, IN2005, IN6515	15C, 15S, DHU
SHLT140516TN-HR	0.062 R	IN1530, IN2005	25J3G, 25J3J (SHELL MILL), DHU
SHLT140532N-FS	0.125 R	IN2005	DHU
SHLT1405APTN-HR	0.010 R	IN1030, IN40P, IN6530	5N6J
SNED120420	0.078 R	IN2010	DJ1H
SNED1204ANR-DT	0.040 Chamfer	IN80B	DJ1H
SNES1204ANN	0.080 Chamfer	IN2010	DJ1H
SNEV1204ANN-PH	0.080 Chamfer	IN2505	DJ1H
SNGS1205ANN-W	0.015 R	IN2010, IN2505, IN62C	DN6H DN5H
SNGU1205EFN-P	0.093 R	IN10K	DL6H DL5H, DN6H DN5H
SNGU1205ENN	0.093 R	INDD15, IN2030, IN2505, IN2510	DL6H DL5H, DN6H DN5H

GENERAL TECHNICAL INFORMATION

INSERTS

Insert Number	Corner Radius	New Grade	Cutter Series
SNGU130604N	0.015 R	IN2010, IN2030, IN2505	DJ6T, DJ5T
SNGU130608TN	0.031 R	INDD15, IN2010, IN2030, IN2505, IN2540	DJ6T, DJ5T
SNGU130616N	0.062 R	INDD15, IN2030, IN2505, IN2540	DJ6T, DJ5T
SNGU1306ANTN	0.031 Chamfer 45 deg.	INDD15, IN2010	DJ6T, DJ5T
SPEN120608TN	0.031 R	IN70N	5J2H
SPEN120611TR-W	0.031 R	IN70N	5J2H
SPEN1206MPTN	0.096 Faceted	IN70N	5J2H
SPEN1206MPTR-W	0.096 Faceted	IN70N	5J2H
SPLT060204R	0.015 R	IN1030, IN1040, IN30M	15C, 15S, 15T, 12T
SPLT060204R-DM04	0.015 R	IN1030	15C, 15S
SPLT07T308N-PH	0.030 R	IN1030, IN2005, IN6520	DHU (TOP-ON STYLE), INDEXABLE DRILLS 2
TNGU2207PNTN	0.093 R	IN2030, IN2505, IN2510	DJ6H, DJ5H
UHLD08T310R-M	0.118 R	IN2005, IN2030, IN2505	15V1E, 15V1H, 5V6E, 5V6H
UHLD130515R-MM	0.118 R	IN2005, IN2030, IN2040, IN2505, IN2540	15V1E, 15V1H, 5V6E, 5V6H
UNEU1205R	0.118 R	IN2030, IN2505, IN2540, IN6530	1DG1H, DG6H
UNEU1205R	0.118 R	IN2030, IN2505, IN2540, IN6530	1DG1H (TOP-ON STYLE), 4W2A
UNLU0603MOTR	0.078 R	IN2030, , IN2505, IN6530	1TG1F, 1TG1F (TOP-ON STYLE), TG1F
UOMT0602TR	0.040 R	IN2030, IN2505	12J1D, 12J1D (CHIP-SURFER STYLE), 12J1D (STRAIGHT SHANK), 12J1D (TOP-ON STYLE), 2J1D
XEET250408R-P	0.031 R	IN15K	15X1X, 15X1X (TOP-ON STYLE), 5X6X
XEET250408R-PWRWK	0.031 R	IN15K	15X1X, 15X1X (TOP-ON STYLE), 5X6X
XEET25040XR-P	0.031 R	IN15K	15X1X
XEET250416R-P	0.062 R	IN15K	15X1X, 15X1X (TOP-ON STYLE), 5X6X
XEET250424R-P	0.093 R	IN15K	15X1X, 15X1X (TOP-ON STYLE), 5X6X
XEET250432R-P	0.125 R	IN15K	15X1X, 15X1X (TOP-ON STYLE), 5X6X
XEEW250308R-P	0.031 R		15X1W_XEET2503
XEEW250332R-P	0.125 R	IN15K	15X1W_XEET2503
XFEB330504R-P	0.020 (.5mm) R	IN15K	15X1Z, 5X6Z
XFEB330508R-P	0.031 R	IN15K	15X1Z, 5X6Z
XFEB330508R-PW	0.031 R	IN15K	15X1Z, 5X6Z
XFEB330516R-P	0.062 R	IN15K	15X1Z, 5X6Z
XFEB330516R-PW	0.062 R	IN15K	15X1Z, 5X6Z
XFEB330532R-P	0.125 R	IN15K	15X1Z, 5X6Z
XFEB330550L-P	0.197 (5mm) R	IN15K	15X1Z, 5X6Z
XFEB330550R-P	0.197 (5mm) R	IN15K	15X1Z, 5X6Z
XFEB330564R-P	0.250 R	IN15K	15X1Z, 5X6Z
XPET140405FR-P	0.020 R	IN15K	15X1W, 15X1W (HSK ADAPTION), 15X1W (TOP-ON STYLE), 5X6W
XPET140408FR-P	0.031 R	IN15K	15X1W, 15X1W (HSK ADAPTION), 15X1W (TOP-ON STYLE), 5X6W

Insert Number	Corner Radius	New Grade	Cutter Series
XPET140408FR-PW	0.031 Wiper w/ Radius	IN15K	15X1W, 15X1W (HSK ADAPTION), 15X1W (TOP-ON STYLE), 5X6W
XPET140416FR-P	0.062 R	IN15K	15X1W, 15X1W (HSK ADAPTION), 15X1W (TOP-ON STYLE), 5X6W
XPET140424FR-P	0.093 R	IN15K	15X1W, 15X1W (HSK ADAPTION), 15X1W (TOP-ON STYLE), 5X6W
XPET140432FR-P	0.125 R	IN15K	15X1W, 15X1W (HSK ADAPTION), 15X1W (TOP-ON STYLE), 5X6W
YNE324-100	0.031 R	IN2015, IN2030, IN2040, IN6515	5VK6V, VK5V (HI DENSITY), VK6V (COARSE-DENSITY), VK6V (MEDIUM-DENSITY)
YXM324L001	0.031 R	IN1505, IN1510, IN1540	SF6H, SF6N
YXM434L001	0.031 R	IN1505, IN1510, IN1540	SF6H, SF6N

GENERAL TECHNICAL INFORMATION

INSERT SCREW DATA

New Screw Number	Old Screw Number	Drive Size/Style	Thread	Overall Length	Torque		Torx® Drivers/w Interchangeable Bits		
					Setting in. lbs.	Standard Driver	Manual Handle	Preset Torque	Torx Bit
SA060-01	SA04-42	3mm hex	M6 x 1.0	.394	n/a	DS-H03T			
SA-06-37	SA06-37	3/16 hex	3/8-24 UNF	.500	n/a				
SB080-01	WS8	5mm hex			n/a	DS-H05T			
SB080-02	WS8S	5mm hex			n/a	DS-H05T			
SB080-03	D-M8	8mm hex			n/a				
SC-04-17	SC04-17	1/8 hex	1/4-28 UNF	.875	40-45				
SE-03-26	SE03-26	1/8 hex	10-32 UNF	.625	n/a				
SE-03-65	SE03-65	3mm hex	M5 x .8	.630	n/a	DS-H03T			
SE-04-09	SE04-09	5/32 hex	1/4-28 UNF	1.000	n/a				
SE05-031-00	SE02-45	Tx-10	5-40 UNC	.322	20-25	DS-T10T	DS-A00S	DTQ-27W	DS-T10QB
SE06-024-00	SE02-05	Tx-15	6-32 UNC	.241	25-30	DS-T15T	DS-A00S	DT-29-01	DS-T15B
SE06-028-00	SE02-02	Tx-15	6-32 UNC	.280	25-30	DS-T15T	DS-A00S	DT-29-01	DS-T15B
SE06-030-00	SE02-18	Tx-15	6-32 UNC	.300	25-30	DS-T15T	DS-A00S	DT-29-01	DS-T15B
SE06-037-00	SE02-04	Tx-15	6-32 UNC	.360	25-30	DS-T15T	DS-A00S	DT-29-01	DS-T15B
SE06-038-10	SE02-23	3/32 hex	6-32 UNC	.375	n/a				
SE06-042-00	SE02-11	Tx-15	6-32 UNC	.430	25-30	DS-T15T	DS-A00S	DT-29-01	DS-T15B
SE08-051-00	SE02-65	Tx-15	8-32 UNC	.522	30-35	DS-T15T	DS-A00S	DT-35-02	DS-T15B
SE10-061-00	SE03-10	Tx-15	10-32 UNF	.610	30-35	DS-T15T	DS-A00S	DT-35-02	DS-T15B
SE10-046-00	SE03-12	Tx-15	10-32 UNF	.460	30-35	DS-T15T	DS-A00S	DT-35-02	DS-T15B
SE10-049-00	SE03-23	Tx-15	10-32 UNF	.500	30-35	DS-T15T	DS-A00S	DT-35-02	DS-T15B
SE25-063-10	SE04-13	Tx-25	1/4 x 28 NF	.610	40-45	DS-T25T	DS-A00S	DT-40-01	DS-T25B
SF050-01	SF03-11	Tx-15	M5 x .8	.417	53-58	DS-T15T	DS-A00S		DS-T15B
SF060-01	SF03-12	Tx-20	M6 x 1.0	.535	65-70	DS-T20T	DS-A00S		DS-T20B
SF080-01	SF05-15	Tx-25	M8 x 1.25	.661	105-110	DS-T25T	DS-A00S		DS-T25B
SF080-02	SF05-16	Tx-25	M8 x 1.25	.820	105-110	DS-T25T	DS-A00S		DS-T25B
SM18-041-00	SM18-041-00	Tx-6IP	M1.8 x .35	.161	5	DS-TP06S		DTN005S	DS-TP06TB
SM22-052-00	SE01-16	Tx-07	M2.2 x .45	.205	7.5-8.5	DS-T07F	DS-A00S	DTQ-08W	DS-T07QB
SM25-049-00	SM25-05	Tx-08	M2.5 x .45	.191	9-11.5	DS-T08W	DS-A00S	DTQ-11W	DS-T08QB
SM25-052-80		Tx-06	M2.5 x .45	.204	5	DS-T06F		DTQ-05W	DS-T06QB
SM25-054-00	SE01-17	Tx-08	M2.5 x .45	.211	9-11.5	DS-T08W	DS-A00S	DTQ-11W	DS-T08QB
SM25-055-10	SE01-18	Tx-08	M2.5 x .45	.217	9-11.5	DS-T08W	DS-A00S	DTQ-11W	DS-T08QB
SM25-064-00	HZT.0001	Tx-08	M2.5 x .45	.250	9-11.5	DS-T08W	DS-A00S	DTQ-11W	DS-T08QB
SM25-072-30	SE01-21	Tx-07	M2.5 x .45	.287	7.5-8.5	DS-T07F	DS-A00S	DTQ-08W	DS-T07QB
SM25-075-20	TS25075I/HG	Tx-08	M2.5 x .45	.295	9-11.5	DS-T08W	DS-A00S	DTQ-11W	DS-T08QB
SM25-075-60	TS25A075I/HG	Tx-08	M2.5 x .45	.295	9-11.5	DS-T08W	DS-A00S	DTQ-11W	DS-T08QB
SM30-053-00	SM31-06	Tx-09	M3 x .5	.209	13-18	DS-T09W	DS-A00S	DTQ-18W	DS-T09QB
SM30-065-00	SE02-79	Tx-09	M3 x .5	.256	13-18	DS-T09W	DS-A00S	DTQ-18W	DS-T09QB
SM30-074-21		Tx-08	M3 x .5	.293	13-18	DS-T08W	DS-A00S	DTQ-18W	DS-T08QB
SM30-080-10		Tx-09	M3 x .5	.315	13-18	DS-T09W	DS-A00S	DTQ-18W	DS-T09QB
SM30-082-00	HZT.0028	Tx-09	M3 x .5	.323	13-18	DS-T09W	DS-A00S	DTQ-18W	DS-T09QB
SM30-082-B0	TS30F100	Tx-10IP	M3 x .5	.327	13-18	TD-10P			
SM30-082-21		Tx-08	M3 x .5	.323	13-18	DS-T08W	DS-A00S	DTQ-18W	DS-T08QB
SM35-034-50	HZT.0021	Tx-09	M3.5 x .6	.134	13-18	DS-T09W	DS-A00S	DTQ-18W	DS-T09QB
SM35-042-50	HZT.0022	Tx-09	M3.5 x .6	.165	13-18	DS-T09W	DS-A00S	DTQ-18W	DS-T09QB
SM35-076-10		Tx 10	M3.5 x .6	.300	25-30	DS-T10T	DS-A00S	DTQ-27W	DS-T10QB
SM35-088-10	HZT.0003	Tx-10	M3.5 x .6	.346	25-30	DS-T10T	DS-A00S	DTQ-27W	DS-T10QB
SM35-089-00	SE02-B2	Tx-15	M3.5 x .6	.350	25-30	DS-T15T	DS-A00S	DTQ-27W	DS-T15B
SM35-090-40	SE02-A8	Tx-10	M3.5 x .6	.354	18-22	DS-T10T	DS-A00S	DTQ-18W	DS-T10QB

INSERT SCREW DATA

New Screw Number	Old Screw Number	Drive Size/Style	Thread	Overall Length	Torque		Torx® Drivers/w Interchangeable Bits		
					Setting in. lbs.	Standard Driver	Manual Handle	Preset Torque	Torx Bit
SM35-097-00	SE02-C3	Tx-15	M3.5 x .6	.380	25-30	DS-T15T	DS-A00S	DTQ-27W	DS-T15B
SM35-110-00	SE02-63	Tx-15	M3.5 x .6	.433	25-30	DS-T15T	DS-A00S	DTQ-27W	DS-T15B
SM35-114-H0		Tx-15	M3.5 x .6	.449	25-30	DS-T15T	DS-A00S	DTQ-27W	DS-T15B
SM40-050-50	HZT.0023	Tx-15	M4 x .7	.197	30-35	DS-T15T	DS-A00S	DT-35-02	DS-T15B
SM40-060-50	HZT.0024	Tx-15	M4 x .7	.236	30-35	DS-T15T	DS-A00S	DT-35-02	DS-T15B
SM40-070-00	SM40-07	Tx-15	M4 x .7	.276	30-35	DS-T15T	DS-A00S	DT-35-02	DS-T15B
SM40-080-00	SM40-08D	Tx-15	M4 x .7	.315	30-35	DS-T15T	DS-A00S	DT-35-02	DS-T15B
SM40-080-10	SM41-09	Tx-15	M4 x .7	.315	30-35	DS-T15T	DS-A00S	DT-35-02	DS-T15B
SM40-080-30	SE02-B3	Tx-15	M4 x .7	.315	30-35	DS-T15T	DS-A00S	DT-35-02	DS-T15B
SM40-084-20	SE02-B7	Tx-15	M4 x .7	.337	30-35	DS-T15T	DS-A00S	DT-35-02	DS-T15B
SM40-090-00	SE02-55	Tx-15	M4 x .7	.354	30-35	DS-T15T	DS-A00S	DT-35-02	DS-T15B
SM40-093-20	SE02-82	Tx-15	M4 x .7	.354	30-35	DS-T15T	DS-A00S	DT-35-02	DS-T15B
SM40-100-10		Tx-15	M4 x .7	.394	30-35	DS-T15T	DS-A00S	DT-35-02	DS-T15B
SM40-100-R0		Tx-15	M4 x .7	.394	30-35	DS-T15T	DS-A00S	DT-35-02	DS-T15B
SM40-106-B0	TS40F120	Tx-15IP	M4 x .7	.470	25-30	TD-15P		DT-35-02	
SM40-110-00	SE02-78	Tx-15	M4 x .7	.433	30-35	DS-T15T	DS-A00S	DT-35-02	DS-T15B
SM40-120-00	SE02-75	Tx-15	M4 x .7	.472	30-35	DS-T15T	DS-A00S	DT-35-02	DS-T15B
SM40-120-20	SE02-81	Tx-15	M4 x .7	.472	30-35	DS-T15T	DS-A00S	DT-35-02	DS-T15B
SM40-120-40	SE02-A9	Tx-15	M4 x .7	.472	30-35	DS-T15T	DS-A00S	DT-35-02	DS-T15B
SM40-130-00	SE02-83	Tx-15	M4 x .7	.512	30-35	DS-T15T	DS-A00S	DT-35-02	DS-T15B
SM40-143-H0		Tx-15	M4 x .7	.561	30-35	DS-T15T	DS-A00S	DT-35-02	DS-T15B
SM45-120-R0	TS45120I	Tx-20	M4.5 x .75	.472	35-40	DS-T20T	DS-A00S	DT-40-01	DS-T20B
SM50-096-20	SE03-68	Tx-20	M5 x .8	.377	40-45	DS-T20T	DS-A00S	DT-40-01	DS-T20B
SM50-100-00	SM50-10B	Tx-20	M5 x .8	.393	35-40	DS-T20T	DS-A00S	DT-40-01	DS-T20B
SM50-100-10	SE03-79	Tx-20	M5 x .8	.393	40-45	DS-T20T	DS-A00S	DT-40-01	DS-T20B
SM50-105-10	SM52-10	Tx-20	M5 x .8	.240	40-45	DS-T20T	DS-A00S	DT-40-01	DS-T20B
SM50-120-00	SE03-58	Tx-15	M5 x .8	.472	30-35	DS-T15T	DS-A00S	DT-35-02	DS-T15B
SM50-120-10	SM52-12	Tx-20	M5 x .8	.472	40-45	DS-T20T	DS-A00S	DT-40-01	DS-T20B
SM50-120-30	HZT.0026	Tx-20	M5 x .8	.472	40-45	DS-T20T	DS-A00S	DT-40-01	DS-T20B
SM50-127-10	SE03-72	Tx-20	M5 x .8	.500	40-45	DS-T20T	DS-A00S	DT-40-01	DS-T20B
SM50-130-R0		Tx-20	M5 x .8	.512	40-45	DS-T20T	DS-A00S	DT-40-01	DS-T20B
SM50-138-B0	TS50F160	3mm hex	M5 x .8	.630	40-45	L-W3		DT-40-01	
SM50-150-40	SE03-80	Tx-20	M5 x .8	.591	40-45	DS-T20T	DS-A00S	DT-40-01	DS-T20B
SM50-160-10	SE03-70	Tx-20	M5 x .8	.625	40-45	DS-T20T	DS-A00S	DT-40-01	DS-T20B
SM50-190-00	SM50-19	Tx-20	M5 x .8	.748	40-45	DS-T20T	DS-A00S	DT-40-01	DS-T20B
SM50-190-10	SM52-19	Tx-20	M5 x .8	.748	40-45	DS-T20T	DS-A00S	DT-40-01	DS-T20B
SM50-200-40	SE03-81	Tx-20	M5 x .8	.787	40-45	DS-T20T	DS-A00S	DT-40-01	DS-T20B
SM60-093-S0	TS6040093S	4mm hex	M6 x 1.0	.366	40-45	DS-H40T		DT-40-01	
SM60-150-00		Tx-25	M6 x 1.0	.591	72-77	DS-T25T	DS-A00S		DS-T25B
SM60-127-00		Tx-25	M6 x 1.0	.500	72-77	DS-T25T	DS-A00S		DS-T25B
SM60-165-B0	TS60F200	4mm hex	M6 x 1.0		50-55	L-W4			
SM60-180-00		Tx-25	M6 x 1.0	.709	50-55	DS-T25T	DS-A00S		DS-T25B
SM60-220-40	SE03-88	4mm hex	M6 x 1.0	.866	72-77	DS-H04T			
SM70-210-B0	TS70F250	4mm hex	M7	.827	80-85	L-W4			
SM80-250-B0	TS80F300	4mm hex	M8 x 1.25	.985	95-100	L-W4			
STC-35	STC-35	1/8 hex	(2) 1/4-28 UNF	.781	75				

GENERAL TECHNICAL INFORMATION

STANDARD RETENTION BOLT DATA CHART

New Bolt Number	Old Bolt Number	Drive Size/Style	Thread	Head Diameter	Standard Length
SD-04-85	SD04-85	3/16 hex	1/4-28 UNF	3/8	.875
SD-06-46	SD06-46	5/16 hex	3/8-24 UNF	9/16	1.00
SD-06-47	SD06-47	5/16 hex	3/8-24 UNF	9/16	1.25
SD-06-48	SD06-48	5/16 hex	3/8-24 UNF	9/16	1.50
SD-06-49	SD06-49	5/16 hex	3/8-24 UNF	9/16	1.75
*SD-06-89	SD06-89-	5/16 hex	3/8-24 UNF	9/16	1.00
SD-07-13	SD07-13	10mm hex	M12 x 1.75	18mm	2.17
SD012-40	SD08-21	10mm hex	M12 x 1.75	18mm	1.57
SD-08-46	SD08-46	3/8 hex	1/2-20 UNF	3/4	1.00
SD-08-47	SD08-47	3/8 hex	1/2-20 UNF	3/4	1.25
SD-08-48	SD08-48	3/8 hex	1/2-20 UNF	3/4	1.50
SD-08-52	SD08-52	3/8 hex	1/2-20 UNF	3/4	2.50
*SD-08-92	SD08-92-	3/8 hex	1/2-20 UNF	3/4	1.00
SD-08LA2	SD08LA2	1/2 hex	1/2-13 UNC-LH	3/4	5.75
SD-10-46	SD10-46	1/2 hex	5/8-18 UNF	15/16	1.00
SD-10-47	SD10-47	1/2 hex	5/8-18 UNF	15/16	1.25
SD10-48	SD10-48	1/2 hex	5/8-18 UNF	15/16	1.50
SD-10-51	SD10-51	1/2 hex	5/8-18 UNF	15/16	2.25
SD-10-54	SD10-54	1/2 hex	5/8-18 UNF	15/16	3.00
*SD-10-99	SD10-99-	1/2 hex	5/8-18 UNF	15/16	1.25
SD-12-82	SD12-82-	5/8 hex	3/4-16 UNF	1-1/8	1.50
*SD-12-99	SD12-99-	5/8 hex	3/4-16 UNF	1-1/8	1.50
*CZ-0097		1/2 hex	3/4-16 UNF	2-1/4	2.00

*Equipped with coolant through.

STANDARD SCREW DRIVER CHART

Drive Size/Style	Standard Driver		Manual Handle		Torx Bit	
	New Part No.	Old Part No.	New Part No.	Old Part No.	New Part No.	Old Part No.
Tx-61P	DS-TP06	-	-	-	-	-
Tx-06	DS-T06F	DS-0038	DS-A00S	DS-0017	-	-
Tx-07	DS-T07F	DS-0036	DS-A00S	DS-0017	DS-T07B	DS-0028
Tx-08	DS-T08W	DS-0020	DS-A00S	DS-0017	DS-T08B	DS-0021
Tx-09	DS-T09W	DS-0022	DS-A00S	DS-0017	DS-T09B	DS-0029
Tx-10	DS-T10T	DS-0013	DS-A00S	DS-0017	DS-T10B	DS-0004
Tx-101P	TD-10P	-	-	-	-	-
Tx-15	DS-T15T	DS-0010	DS-A00S	DS-0017	DS-T15B	DS-0003
Tx-20	DS-T20T	DS-0034	DS-A00S	DS-0017	DS-T20B	DS-0035
Tx-25	DS-T25T	DS-0037	DS-A00S	DS-0017	DS-T25B	DS-0030
Tx-30	DS-T30T	-	-	-	DS-T30B	-
Tx-40	DS-T40T	-	-	-	DS-T40B	-
Tx-50	DS-T50L	-	-	-	DS-T50B	-
2mm hex	-	WS-0014	-	-	-	-
3mm hex	DS-H03T	DS-0033	-	-	-	-
4mm hex	DS-H04T	DS-0039	-	-	-	-
5mm hex	DS-H05T	WS-0023	-	-	-	-
6mm hex	-	WS-0024	-	-	-	-
1/8 hex	-	WS-0022	-	-	-	-

QWIKLIGHT™

QUICK CHANGE TORQUE DRIVER SYSTEM WITH BRIGHT LED DISPLAY.

Ingersoll brings a high tech and economical solution that will ensure your tooling screws are clamped to the correct torque value. An LED beacon shines brightly when the required clamping torque is reached.

FEATURES:

- Torque accuracy is +/- 6% to prolong the life of your locking screws.
- Interchangeable bit system for versatility of size/torque.
- Color coded Torx® driver and bit system.
- Long life battery needs no replacement.
- Hardened Steel Bits for long life.
- Qwik change bits.



Operating Instructions:

- Turn key clockwise. When reaching the required torque, the LED light will be activated.
- Operation temperature: 18-28°C, 64.4-82.4°F

Service:

- Keep the QwikLight clean and dry, without lubrication.

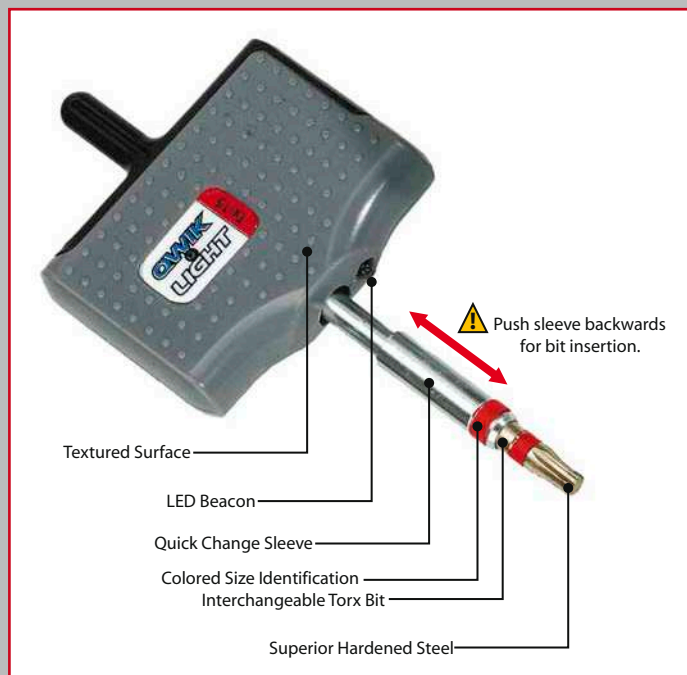

FULL RANGE OF COLOR CODED DRIVERS AND TIPS:

Torx® Size	Torque N•m	(Inch lbs.)	Torx® Size Color Identification
TX-06	0.60	(5.3)	White
TX-07	0.90	(8.0)	Black
TX-08	1.20	(10.6)	Green
TX-09	1.40	(12.4)	Blue
TX-10	2.00	(17.7)	Yellow
TX-15	3.00	(26.6)	Red

TORQUE DRIVERS

STOCK ITEMS:

Item Number	Description	Part Number	Torque	Color
7011852	Qwik-Light Driver	DTQ-05W	5.3 in. lbs.	White
7011853	Qwik-Light Driver	DTQ-08W	8.0 in. lbs.	Black
7011854	Qwik-Light Driver	DTQ-11W	10.6 in. lbs.	Green
7011855	Qwik-Light Driver	DTQ-13W	12.4 in. lbs.	Blue
7011856	Qwik-Light Driver	DTQ-18W	17.7 in. lbs.	Yellow
7011857	Qwik-Light Driver	DTQ-27W	26.6 in. lbs.	Red

Item Number	Description	Part Number	Torque	Color
7011858	Qwik-Light Driver w/ TX-6 Bit	DTQ-05WK	5.3 in. lbs.	White
7011859	Qwik-Light Driver w/ TX-7 Bit	DTQ-08WK	8.0 in. lbs.	Black
7011860	Qwik-Light Driver w/ TX-8 Bit	DTQ-11WK	10.6 in. lbs.	Green
7011861	Qwik-Light Driver w/ TX-9 Bit	DTQ-13WK	12.4 in. lbs.	Blue
7011862	Qwik-Light Driver w/ TX-10 Bit	DTQ-18WK	17.7 in. lbs.	Yellow
7011863	Qwik-Light Driver w/ TX-15 Bit	DTQ-27WK	26.6 in. lbs.	Red

Item Number	Description	Part Number	Color
7011870	5 PAK of Qwik-Light TX-6 Bits	DS-T06QB 5pc	White
7011872	5 PAK of Qwik-Light TX-7 Bits	DS-T07QB 5pc	Black
7011874	5 PAK of Qwik-Light TX-8 Bits	DS-T08QB 5pc	Green
7011876	5 PAK of Qwik-Light TX-9 Bits	DS-T09QB 5pc	Blue
7011878	5 PAK of Qwik-Light TX-10 Bits	DS-T10QB 5pc	Yellow
7011880	5 PAK of Qwik-Light TX-15 Bits	DS-T15QB 5pc	Red

Item Number	Description	Part Number	Color
7011871	10 PAK of Qwik-Light TX-6 Bits	DS-T06QB 10pc	White
7011873	10 PAK of Qwik-Light TX-7 Bits	DS-T07QB 10pc	Black
7011875	10 PAK of Qwik-Light TX-8 Bits	DS-T08QB 10pc	Green
7011877	10 PAK of Qwik-Light TX-9 Bits	DS-T09QB 10pc	Blue
7011879	10 PAK of Qwik-Light TX-10 Bits	DS-T10QB 10pc	Yellow
7011881	10 PAK of Qwik-Light TX-15 Bits	DS-T15QB 10pc	Red

QWIK TORQUE™

TORQUE DRIVERS THAT "CAM-OUT" FOR THE UTMOST IN ACCURACY AND PROTECTION.

FEATURES:

- Qwik Change Bits.
- Comfortable Grip Rubberized Handles.
- Steel Bits are Hardened for Long Life.
- DT-35 and DT-40 Drivers for higher torque requirements with TX-15 and TX-20 screws.



DRIVERS:

Item Number	Description	Part Number	Torque
7011223	Torque Driver Handle	DTN005S	5in. lbs
7018948	Torque Driver Handle	DT-35-02	35in. lbs.
7011847	Torque Driver Handle	DT-40-01	40in. lbs.

INTERCHANGEABLE BITS:

Item Number	Description	Part Number
7011224	TX Plus 06 Bit	DS-TP06TB
7000078	TX 15 Bit (1/4" Hex Shank)	DS-T15B
7011883	TX 15 Bit (1/4" Hex Shank) long	DS-T15B1
7001303	TX 20 Bit (1/4" Hex Shank)	DS-T20B
7018957	TX 20 Bit (1/4" Hex Shank) long	DS-T20B1



Short bit for "on-edge" product.

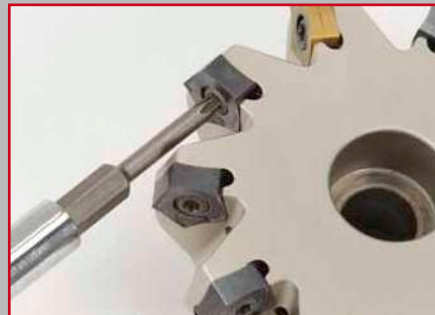

Long bit for traditional mounted inserts.

INDEX

End Mills, Angle Mills

Series 12J1R, 12J1X, 12V1X, 12R1X, 22J3X, 22N3X, 12J1G, 12V1G, 12J1B, 12J4B, 12R1B, 12N1B, 12S1B, 22J5B, 22J3B, 22J3G, 22J3Q.....	346
Series 15L1G, 15M1G, 15N1F, 15N1G.....	346
Series 12J1D, 22J3D, 12P1D, 12N1D, 12M1D.....	347
Series 15J1H.....	347
Series 12J1Q, 12R1Q, 12M1Q, 12N1Q, 12P1Q, 12S1Q, 22J3Q, 22J7Q.....	348
Series 15M1H, 15N1H.....	349
Series 12J1P, 22J3P, 2J1P.....	349
Series 15R1V, 15R4H.....	350
Series 22J3F, 12J1F.....	350
Series 27E2V.....	351
Series 25J3F, 25J3G, 25J3H, 25J3J, 23J.....	351
Series 15X1W, 15X1X, 15U1G.....	352
Series 15X1Z.....	352
Series 12J1E, 22J3E.....	352
Series 1TJ1N, 2TJ3N, TJ5N, TJ6N, TN1N.....	353
Series 25J3E, 15N1E, 15P1E, 15J1E.....	353
Series 15N1F, 15N1H.....	346
Series 2SJ1L.....	354
Series 2SJ1H.....	355
Series 1SJ1Y, 2SJ3Y, SJ5Y, SJ6Y.....	355
Series 1SJ1F, SJ5F, SJ5H, SJ6F, 2SJ3F.....	356
Series SJ2J, SJ5J, SJ6J, 2SJ3J, SN2J, SN6J.....	356

Face Mills

Series 2L1Q, 2J1Q, 2J1D.....	358
Series 2J1E, 2J4E, 2L1E.....	358
Series 2J1P, 22J3P, 2J1P.....	349
Series 2J1X, 2J1G, TFM90, 2J4B, 2L6B.....	359
Series 5J1E, 2J1F.....	359
Series 5J1H, 5J2H.....	360
Series 5N6F, 5N2H.....	361
Series ON5H, ON6H, OP1N, OP6N.....	362
Series 5N6J, 5N6R.....	362
Series 5N6H, 5N6K, 5N2L.....	363
Series DN5H/DN6H, DL5H/DL6H, DJ5H/DJ6H.....	364
Series DJ6T, DJ5T.....	364
Series 6X1V, 6X2V, 6X3V, 6X4V.....	365
Series DM5G, DM6G.....	365
Series SJ2R, SN2R.....	365
Series SF6H, SF6N.....	366
Series SJ2N, SJ6N, SN2N, SN6N, 2SJ1N, VM2N.....	366
Series SJ6H, SJ5E, SJ6H.....	367
Series SJ5V, SJ6V.....	368

Contour Milling

Series VM6V, VL6V, VK6V, VK5V.....	369
Series 12W.....	370
Series 15V1E, 5V6E, 1TG1F, TG1F.....	370
Series 15V1H, 5V6H.....	371
Series 15V1Z, 5V6G, 15V1D, 15V1G.....	371
Series SP6H/SP6N.....	372
Series DG6H, 1DG1H, 1DP1G, DP5G.....	372
Series 15W7V, 25W1V.....	373
Series 13W7X, 23W1X.....	373
Series 15B.....	374
Series 1DB1H, DW_H, TFMR, TBRP.....	374
Series 5W7.....	375
Series 5W.....	375
Series 5W6S.....	376
Series VHU.....	376
Series SHU.....	377
Series DHU.....	377
Series 5E6K, 15E1K.....	378
Series 2BW3Y, 1BW7W, 1BW7Y, 1BW8V.....	379

Slotters

Series 31J, TSC_K, TSC_A.....	380
Series 35J, 38L.....	380
Series 3SJ6E, 3SJ6H.....	381
Series 3SJ6L.....	381
Series 15T, 12T.....	382
Series 5VK6V, 3VL5V.....	382

GENERAL OPERATING GUIDELINES

THESE OPERATING GUIDELINES ARE RECOMMENDED STARTING POINTS FOR SAFE, EFFECTIVE PERFORMANCE IN A VARIETY OF MATERIALS

The parameters outlined on the following pages represent recommended general operating guidelines. They are intended to act as starting points as you look for the optimum operating parameters for a specific application.

Optimum parameters for any application are bound to vary according to the unique combination of variables which may be present in that particular application. Such variables might include the machine tool condition, rigidity of the workpiece and fixturing, the work material condition, the precise hardness and machinability of the material, and the shape and finish requirements of the workpiece, to name a few.

Once the application is operating reasonably well and safely, adjustments to these guidelines can be made based on variables present and the performance of the tool.

Extended length end mills require special operating parameters. They are NOT intended for channel cutting. Feed rates must generally be reduced due to their length-to-diameter ratios. Always use the shortest extension possible for best performance. Refer to "Rigidity Analysis" on [page 310](#).

When ball nose end milling, two critical parameters are directly affected by the Depth of Cut (DOC): cutting speed in Surface Feet per Minute (SFM) and chip thickness. It is necessary to recognize these factors and to follow the guidelines relating to them. Refer to "Ball Nose Chip Thinning" on [page 312](#).

For additional information regarding specific grades, refer to the grade chart on [page 322](#). If you have questions regarding a specific application, contact your Ingersoll Cutting Tool Company sales engineer for assistance.

END MILL OPERATING GUIDELINES

Series 12J1R, 12J1X, 12V1X, 12R1X, 22J3X, 22N3X, 12J1G, 12V1G, 12J1B, 12J4B, 12R1B, 12N1B, 12S1B, 22J5B, 22J3B, 22J3G, 22J3Q					Grades							Coolant
Material	Brinell Hardness	SFM	Feed per Insert	IN1DK	IN2005/IN2505	IN2010/IN2510	IN1030	IN2030	IN2040	INDD15		
Aluminum	7075-T6, 6061-T6, 2024	-	1500-8000	.004-.010	1	3	2				Yes	
Cast Iron	Gray	150-250	300-1000	.004-.010		3	1			2	No	
	Nodular		300-600									
Steel	Low Carbon 1018-8620	100-250	400-1000	.004-.010		2		1	1*	3	No	
	High Carbon F-6180	250-400	350-500	.004-.008								
	Alloyed Steel 4140, 4340	150-300	300-700	.004-.010		3		1	1*	2		
	Tool Steel A-6, D-1, D-2	Up to 300										
Stainless Steel	300 Series, 304, 316	-	300-700	.004-.010		2		1	1*	3	May not be required at high speeds	
	400 Series 15-5 PH	-	400-900								Yes	
	13-8 PH	-	200-400									
Nickel Alloys	Inconel 600, 706, 718, 903, Hastelloy, Waspalloy	-	75-120	.003-.006		2	3	1	1*		Yes	
Titanium	6AL-4V	-	100-150	.005-.008		2		1	1		Yes	

*Preferred for higher SFM.

Series 15L1G, 15M1G, 15N1F, 15N1G					Grades							Coolant		
Material	Brinell Hardness	SFM	Feed per Insert	IN30M	IN40P	IN2005	IN1030	IN6530	SHLT11	IN2005	IN1030		IN6515	SHLT09
Aluminum	7075-T6, 6061-T6, 2024	-	1000-8000	.010-.020	1						1			Yes
Cast Iron	Gray	150-250	250-400	.006-.010			2	1	1		2	3	1	No
	Nodular		200-350											
Steel	Low Carbon 1018, 8620	100-250	250-500	.006-.010		3	2	1	4		2	1		No
	High Carbon F-6180	250-400	200-350	.005-.008										
	Alloyed Steel 4140, 4340	150-300	250-400	.006-.010		3	2	1	4		2	1		
	Tool Steel A-6, D-1, D-2	Up to 300												
Stainless Steel	300 Series, 304, 316	-	250-400	.005-.008										May not be required at high speeds
	400 Series 15-5 PH	Up to 320	300-600		3		2	1	3		2	1	3	Yes
	13-8 PH	-	200-250											
Nickel Alloys	Inconel 600, 706, 718, 903, Hastelloy, Waspalloy	-	75-120	.004-.006	3		2	1	3		2	1		Yes
Titanium	6AL-4V	-	100-150	.004-.006	3		2	1			2	1		Yes

The success of any cutter application is a function of many variables. Our initial preference of grade is based on applying a more tough grade.

Series 12J1D, 22J3D, 12P1D, 12N1D, 12M1D					Grades			
Material	Brinell Hardness	SFM	Feed per Insert	IN05S	IN200S/IN250S	IN1030	IN2030	Coolant
Aluminum	6061 T-6, 7075 T-6, 2024	-	1000-8000	.003-.008	1	2		Yes
Cast Iron	Gray	150-250	500-1200	.002-.004		1	2	1
	Nodular		400-800					
Steel	Low Carbon 1018-8620	150-250	600-1200	.002-.004		3	1	2
	High Carbon F-6180, Nitalloy 52100	250-400	400-600					
	Alloyed Steel 4140, 4340, 6150	150-300	400-800					
	Tool Steel A-6, D-1, D-2, P-20	Up to 300						
Stainless Steel	300 Series, 304, 316	-	400-800	.002-.004	2	1	1	May not be required at high speeds
	400 Series 15-5 PH, 17-4 PH	Up to 320	500-1000					
	13-8 PH	-	200-400					Yes
Nickel Alloys	Inconel, Hastelloy, Waspalloy	-	75-120	.002-.003	2	3	1	Yes
Titanium	6AL-4V	-	80-150	.002-.003	2	1	1	Yes

Series 15J1H					Grades		
Material	Brinell Hardness	SFM	Feed per Insert	IN15K	IN1540	Coolant	
Aluminum	6061 T-6, 7075 T-6	-	1000-8000	.003-.005	1	Yes	
Steel	Low Carbon 1018-8620	100-250	400-1000	.003-.006		1	Yes
	High Carbon F-6180, Nitalloy 52100	250-400	300-500				
	Alloyed Steel 4140, 4340, 6150	150-300	300-700				
	Tool Steel A-6, D-1, D-2, P-20	Up to 300					
Stainless Steel	300 Series, 304, 316	-	300-700	.003-.006		1	May not be required at high speeds
	400 Series 15-5 PH, 17-4 PH	-	400-900				
	13-8 PH	-	200-400				Yes

The success of any cutter application is a function of many variables. Our initial preference of grade is based on applying a more tough grade.

END MILL OPERATING GUIDELINES

Series 12J1Q, 12R1Q, 12M1Q, 12N1Q, 12P1Q, 12S1Q, 22J3Q, 22J7Q					Grades								Coolant	
Material	Brinell Hardness	SFM	Feed per Insert	IN30M	IN2005	IN2015	IN1030	IN2030	IN2040	IN5015	IN6530			
Aluminum	6061 T-6, 7075 T-6, 2024	-	1500-8000	.003-.008	1	3	2						Yes	
Cast Iron	Gray	150-250	300-1000	.003-.008		3	1				2		No	
	Nodular		300-600											
Steel	Low Carbon 1018-8620	100-250	400-1000	.003-.008									No	
	High Carbon F-6180, Nitr alloy 52100	250-400	350-500	.003-.006										
	Alloyed Steel 4140, 4340, 6150	150-300	300-700	.003-.007	3		1	1*	2			4		
	Tool Steel A-6, D-1, D-2, P-20	Up to 300												
Stainless Steel	300 Series, 304, 316	-	300-700	.003-.006		2	3	1	1*			4	May not be required at high speeds	
	400 Series 15-5 PH, 17-4 PH	-	400-900											Yes
	13-8 PH	-	200-400											
Nickel Alloys	Inconel 600, 706, 718, 903, Hastelloy, Waspalloy	-	75-120	.003-.006	2		1	3					Yes	
Titanium	6AL-4V	-	100-150	.003-.006			2		1	1			Yes	

*Preferred for higher SFM.

The success of any cutter application is a function of many variables. Our initial preference of grade is based on applying a more tough grade.

Series 15M1H, 15N1H		Brinell Hardness	SFM	Feed per Insert	Grades		Coolant
Material					IN15K	IN1540	
Aluminum	6061 T-6, 7075-T6	-	1000-8000	.003-.006	1	2	Yes
Cast Iron	Gray	150-250	300-1000	.003-.006		1	No
	Nodular		300-600				
Steel	Low Carbon 1018-8620	100-250	400-1000	.003-.006		1	No
	High Carbon F-6180, Nitralloy 52100	250-400	300-500				
	Alloyed Steel 4140, 4340, 6150	150-300	300-700				
	Tool Steel A-6, D-1, D-2, P-20						
Stainless Steel	300 Series, 304, 316	-	300-700	.003-.006		1	May not be required at high speeds
	400 Series 15-5 PH, 17-4 PH	-	400-900				
	13-8 PH	-	200-400				Yes

Series 12J1P, 22J3P, 2J1P		Brinell Hardness	SFM	Feed per Insert	Grades			Coolant
Material					IN10K	IN2305	IN2030	
Aluminum	6061 T-6, 7075 T-6, 2024	-	1000-8000	.003-.006	1			Yes
Cast Iron	Gray	150-250	500-1200	.002-.006		1	2	No
	Nodular		400-800					
Steel	Low Carbon 1018-8620	150-250	600-1200	.002-.006		2	1	No
	High Carbon F-6180, Nitralloy 52100	250-400	400-600	.002-.005		2	1	
	Alloyed Steel 4140, 4340, 6150	150-300	400-800					
	Tool Steel A-6, D-1, D-2, P-20							
Stainless Steel	300 Series, 304, 316	-	400-800					.002-.005
	400 Series 15-5 PH, 17-4 PH	Up to 320	500-1000					
	13-8 PH	-	200-400	Yes				
Nickel Alloys	Inconel, Hastelloy, Waspalloy	-	75-120	.002-.004		2	1	Yes
Titanium	6AL-4V	-	80-150	.002-.005		2	1	Yes

The success of any cutter application is a function of many variables. Our initial preference of grade is based on applying a more tough grade.

END MILL OPERATING GUIDELINES

Series 15R1V, 15R4H		Brinell Hardness	SFM	Feed per Insert	Grades		Coolant
Material					IN2030	IN2040	
Aluminum	7075-T6, 6061-T6, 2024	-	1500-8000	.004-.006	1		Yes
Cast Iron	Gray	150-250	700-1500	.004-.006	1		No
	Nodular						
Steel	Low Carbon 1018, 8620	100-250	600-1500	.004-.006	1	2	No
	High Carbon F-6180	250-400					
	Alloyed Steel 4140, 4340	150-300					
	Tool Steel A-6, D-1, D-2	Up to 300					
Stainless Steel	300 Series, 304, 316	-	350-1000	.004-.006	1	2	May not be required at high speeds
	400 Series, 15-5 PH, 17-4 PH	-					Yes
	13-8 PH	-					
Nickel Alloys	Inconel 600, 706, 718, 903, Hastelloy, Waspalloy	-	75-120	.004-.006	1		Yes
Titanium	6AL-4V	-	100-150	.004-.006	1		Yes

Series 22J3F, 12J1F, 2J1F		Brinell Hardness	SFM	Feed per Insert	Grades*						Coolant					
Material					IN30M	IN2005	IN2015	IN1030	IN2030	IN2040						
Aluminum	6061 T-6, 7075 T-6, 2024	-	1500-8000	.004-.010	1	3	2					Yes				
Cast Iron	Gray	150-250	300-1000	.004-.010	2	1	3	3				No				
	Nodular		300-600													
Steel	Low Carbon 1018, 8620	100-250	400-1000	.004-.010	2		1	1*	3			No				
	High Carbon F-6180, Nitralloy 52100	250-400	350-500	.004-.008												
	Alloyed Steel 4140, 4340, 6150	150-300	300-700	.004-.010									3	1	1*	2
	Tool Steel A-6, D-1, D-2, P-20	Up to 300														
Stainless Steel	300 Series, 304, 316	-	300-700	.004-.010	2	3	1	1*				May not be required at high speeds				
	400 Series 15-5 PH, 17-4 PH	Up to 320	400-900									Yes				
	13-8 PH	-	200-400									.004-.008				
Nickel Alloys	Inconel 600, 706, 718, 903, Hastelloy, Waspalloy	-	75-120	.003-.006	2	3	1	1				Yes				
Titanium	6AL-4V	-	100-150	.003-.006	2		1	1				Yes				

*Preferred for higher SFM.

The success of any cutter application is a function of many variables. Our initial preference of grade is based on applying a more tough grade.

Series 27E2V		Material	Brinell Hardness	SFM	Feed per Insert	Grades			Coolant
						IN30M	IN1530	IN5530	
Cast Iron	Gray	150-250	250-400	.006-.010	2	1	3	No	
	Nodular		200-350						
Steel	Low Carbon 1018-8620	150-250	250-500	.006-.010	2	1	2	No	
	High Carbon F-6180, Nitralloy 52100	250-400	200-350	.005-.008					
	Alloyed Steel 4140, 4340, 6150	150-300	250-400	.006-.010					
	Tool Steel A-6, D-1, D-2, P-20	Up to 300							
Stainless Steel	300 Series, 304, 316	-	250-400	.005-.008	2	1	2	May not be required at high speeds	
	400 Series 15-5 PH, 17-4 PH	Up to 320	300-600					Yes	
	13-8 PH	-	200-250						
Nickel Alloys	Inconel 600, 706, 718, 903, Hastelloy, Waspalloy	-	75-120	.004-.006	2	1	2	Yes	
Titanium	6AL-4V	-	100-150	.004-.006	2	1		Yes	

Series 25J3F, 25J3G, 25J3H, 25J3J, 23J		Material	Brinell Hardness	SFM	Feed per Insert		Grades										Coolant	
					SHLT, (SHLP-32, 33)	SHLH, (SHLP-44)	Side					End ¹						
						IN2030	IN2015/IN5015	IN2040	IN2005	IN1030	IN6550	IN2005	IN1030	IN2030	IN2040	IN2015		
Aluminum	6061-T6, 7075 T-6	-	1000-8000	.003-.006	.004-.020		1	1	2		1	2				1	Yes	
Cast Iron	Gray	150-250	250-400	.003-.006	.004-.010		1	2								1	No	
	Nodular		200-350															
Steel	Low Carbon 1018-8620	150-250	250-500	.003-.006	.004-.010			3	2	1							No	
	High Carbon F-6180, Nitralloy 52100	250-400	200-350	.003-.006	.004-.008			3	2	1								
	Alloyed Steel 4140, 4340, 6150	150-300	250-400	.003-.006	.004-.010			3	2	1		2	1	1	2			
	Tool Steel A-6, D-1, D-2, P-20	Up to 300	250-400					3	2	1								
Stainless Steel	300 Series, 304, 316	-	250-400	.003-.006	.004-.008	2	3	2	1	1	2	1	1				May not be required at high speeds	
	400 Series 15-5 PH, 17-4 PH	Up to 320	300-600														Yes	
	13-8 PH	-	200-250															
Nickel Alloys	Inconel 600, 706, 718, 903, Hastelloy, Waspalloy	-	75-120	.003-.006	.004-.006	2			2	3	1	2	2				Yes	
Titanium	6AL-4V	-	100-150	.003-.006	.003-.006	1			2	1		2	1	1			Yes	

¹For Series 23J6G and 23S2G only.

The success of any cutter application is a function of many variables. Our initial preference of grade is based on applying a more tough grade.

END MILL OPERATING GUIDELINES

Series 15X1W, 15X1X, 15U1G

Material		Brinell Hardness	SFM	Feed per Insert	Grade	Coolant
Aluminum	7075-T6, 6061-T6, 2024	-	1000-10000	.008-.020	IN15K	Yes

Series 15X1Z

Material		Brinell Hardness	SFM	Feed per Insert	Grade	Coolant
Aluminum	7075-T6, 6061-T2, 2024	-	1000-10000	.008-.020	IN15K	Yes

Series 12J1E, 22J3E

Material		Brinell Hardness	SFM	Feed per Insert	Grades						Coolant
					IN30M/IN35S	IN2005	IN2015	IN1030	IN2030	IN2040	
Aluminum	7075-T6, 6061-T6, 2024	-	1500-8000	.004-.018	1	3	2				Yes
Cast Iron	Gray	150-250	300-1000	.004-.018		2	1				No
	Nodular		300-600								
Steel	Low Carbon 1018-8620	100-250	400-1000	.004-.018		2		1	1*	3	
	High Carbon F-6180	250-400	350-500	.004-.015							No
	Alloyed Steel 4140, 4340	150-300	300-700	.004-.018		3		1	1*	2	
Tool Steel A-6, D-1, D-2	Up to 300										
Stainless Steel	300 Series, 304, 316	-	300-700	.004-.018							May not be required at high speeds
	400 Series, 15-5 PH	-	400-900			2	3	1	1*		
	13-8 PH	-	200-400								
Nickel Alloys	Inconel 600, 706, 718, 903, Hastelloy, Waspalloy	-	75-120	.003-.006		1	3	2	2		Yes
Titanium	6AL-4V	-	100-150	.005-.008		2		1	1		Yes

*Preferred for higher SFM.

The success of any cutter application is a function of many variables. Our initial preference of grade is based on applying a more tough grade.

Series 1TJ1N, 2TJ3N, TJ5N, TJ6N, TN1N					Grades				
Material	Brinell Hardness	SFM	Feed per Insert	IN10K	IN2030	IN2505	IN2540	INDD15/IN2010	Coolant
Aluminum	7075 - T6, 6061 - T6, 2024	-	1500-8000	.004-.018	1				Yes
Cast Iron	Gray	150-250	300-1000	.004-.010		2	1		No
	Nodular		300-600	.004-.010		2	1		No
Steel	Low Carbon 1018, 8620	100-250	400-1000	.004-.010	1	3	2		No
	High Carbon F-6180	250-400	350-500	.004-.008					No
	Alloyed Steel 4140, 4340	150-300	300-700	.004-.010					No
	Tool Steel A-6, D-1, D-2	Up to 300							No
Stainless Steel	300 Series, 304, 316	-	300-550	.004-.010	1	2			May not be required at HighSpeed
	400 Series 15-5 PH	Up to 320	350-600						Yes
	13-8 PH	-	200-400						Yes
Nickel Alloys	Inconel, Hastelloy, Waspalloy	-	75-120	.003-.006	2	1			Yes
Titanium	6AL-4V	-	100-150	.005-.008	1	2			Yes

Series 25J3E, 15N1E, 15P1E, 15J1E					Grades					
Material	Brinell Hardness	SFM	Feed per Insert	IN30M	IN2005	IN2015	IN1030/IN1530	IN2030	IN2040	Coolant
Aluminum	7075-T6, 6061-T6, 2024	-	1500-8000	.003-.008	1					Yes
Cast Iron	Gray	150-250	300-1000	.003-.008	2	1	3	3*		No
	Nodular		300-600							No
Steel	Low Carbon	100-250	400-1000	.003-.008	3	1	1*	2		No
	High Carbon	250-400	350-500	.003-.006						
	Alloyed Steel	150-300	300-700	.003-.007						
	Tool Steel	Up to 300								
Stainless Steel	300 Series, 304, 316	-	300-700	.003-.006	2	1	1*	3	Yes	May not be required at high speeds
	400 Series, 15-5 PH, 17-4 PH	-	400-900							
	13-8 PH	-	200-400							
Nickel Alloys	Inconel 600, 706, 718, 903, Hastelloy, Waspalloy	-	75-120	.003-.006	1	2	2			Yes
Titanium	6AL-4V	-	100-150	.003-.006	2	1	1*			Yes

*Preferred for higher SFM.

The success of any cutter application is a function of many variables. Our initial preference of grade is based on applying a more tough grade.

END MILL OPERATING GUIDELINES

Series 15N1F, 15N1H		Material	Brinell Hardness	SFM	Feed per Insert	Grades					Coolant
						IN30M/IN40P	IN2005	IN2510	IN1030	IN2030	
Aluminum	7075-T6, 6061-T6, 2024	-	1500-8000	.004-.010	1	2					Yes
Cast Iron	Gray	150-250	300-1000	.004-.010		2	1				No
	Nodular		300-600								
Steel	Low Carbon	100-250	400-1000	.004-.010		3		1	1*	2	No
	High Carbon	250-400	350-500	.004-.008							
	Alloyed Steel	150-300	300-700	.004-.010							
	Tool Steel	Up to 300									
Stainless Steel	300 Series, 304, 316	-	300-700	.004-.010	2		1	1*		May not be required at high speeds	
	400 Series, 15-5 PH, 17-4 PH	-	400-900							Yes	
	13-8 PH	-	200-400							Yes	
Nickel Alloys	Inconel 600, 706, 718, 903, Hastelloy, Waspalloy	-	75-120	.003-.006	1		2	2		Yes	
Titanium	6AL-4V	-	100-150	.003-.006	2		1	1*		Yes	

*Preferred for higher SFM.

Series 2SJ1L		Material	Brinell Hardness	SFM	Feed per Insert	Grades				Coolant
						IN2005	IN2015	IN1530	IN2040	
Cast Iron	Gray	150-280	400-750	.007-.018	2	1				No
	Nodular		300-650							
Steel	Low Carbon 1018, 8620	100-250	250-500	.005-.015	1		3	2		No
	High Carbon F-6180	250-400	200-350	.006-.013						
	Alloyed Steel 4140, 4340	150-300	250-400	.006-.015						
	Tool Steel A-6, D-1, D-2	Up to 300								
Stainless Steel	300 Series, 304, 316	-	250-400	.005-.010	2		1		May not be required at high speeds	
	400 Series, 15-5 PH	Up to 300	300-600						Yes	
	13-8 PH	-	200-250						Yes	
Nickel Alloys	Inconel 600, 706, 718, 903, Hastelloy, Waspalloy	-	75-150	.004-.007	1		2		Yes	
Titanium	6AL-4V	-	100-150	.004-.007	2		1		Yes	

The success of any cutter application is a function of many variables. Our initial preference of grade is based on applying a more tough grade.

Series 2SJ1H		Material	Brinell Hardness	SFM	Feed per Insert	Grades				Coolant
						IN2005	IN2015	IN1530	IN2040	
Cast Iron	Gray	150-280	400-750	.003-.006	2	1			No	
	Nodular		300-650							
Steel	Low Carbon 1018, 8620	100-250	250-500	.003-.006	1	2	1	No		
	High Carbon F-6180	250-400	200-350							
	Alloyed Steel 4140, 4340	150-300	250-400	.003-.005						
	Tool Steel A-6, D-1, D-2	Up to 300								
Stainless Steel	300 Series, 304, 316	-	400-600	.003-.006	1	2	May not be required at high speeds			
	400 Series, 15-5 PH	Up to 320	300-600							
	13-8 PH	-	200-600				Yes			
Nickel Alloys	Inconel 600, 706, 718, 903, Hastelloy, Waspalloy	-	75-150	.003-.005	1	2	Yes			
Titanium	6AL-4V	-	100-200	.003-.005	2	1	Yes			

Series 1SJ1V, 2SJ3Y, SJ5Y, SJ6Y		Material	Brinell Hardness	SFM	Feed per Insert	Grades			Coolant
						IN2005	IN2015	IN2030	
Cast Iron	Gray	150-280	400-750	.003-.006	2	1		No	
	Nodular		300-650						
Steel	Low Carbon 1018, 8620	100-250	250-500	.003-.006	1	2	No		
	High Carbon F-6180	250-400	200-350						
	Alloyed Steel 4140, 4340	150-300	250-400	.003-.005					
	Tool Steel A-6, D-1, D-2	Up to 300							
Stainless Steel	300 Series, 304, 316	-	400-600	.003-.006	2	1	May not be required at high speeds		
	400 Series, 15-5 PH	Up to 320	300-600						
	13-8 PH	-	200-600				Yes		
Nickel Alloys	Inconel 600, 706, 718, 903, Hastelloy, Waspalloy	-	75-150	.003-.005	1	2	Yes		
Titanium	6AL-4V	-	100-200	.003-.005	2	2	Yes		

The success of any cutter application is a function of many variables. Our initial preference of grade is based on applying a more tough grade.

END MILL OPERATING GUIDELINES

Series 1SJ1F, SJ5F, SJ5H, SJ6F, 2SJ3F		Material	Brinell Hardness	SFM	Feed per Insert	Grades					Coolant
						IN2005	IN2015	IN2030	IN2040	IN6515	
Cast Iron	Gray	150-250	400-750	.005-.012	3	1			2	No	
	Nodular		300-650								
Steel	Low Carbon 1018, 8620	100-250	400-850	.005-.012	1	3	2		No		
	High Carbon F-6180	250-400	300-500								
	Alloyed Steel 4140, 4340	150-300	300-600	.005-.010							
	Tool Steel A-6, D-1, D-2	Up to 300									
Stainless Steel	300 Series, 304, 316	-	300-600	.005-.012	1	2		May not be required at high speeds			
	400 Series 15-5 PH	-	350-700								
	13-8 PH	-	200-400								
Nickel Alloys	Inconel 600, 706, 718, 903, Hastelloy, Waspalloy	-	75-150	.004-.008	1	2		Yes			
Titanium	6AL-4V, TI-10-2-3, TI-5553	-	75-200	.004-.008	2	1		Yes			

Series SJ2J, SJ5J, SJ6J, 2SJ3J, SN2J, SN6J		Material	Brinell Hardness	SFM	Feed per Insert	Grades					Coolant
						IN1530	IN2005	IN2015	IN2030	IN2040	
Cast Iron	Gray	150-250	400-750	.005-.015	3	1			2	No	
	Nodular		300-650								
Steel	Low Carbon 1018, 8620	100-250	400-850	.005-.014	1	1	2	3	No		
	High Carbon F-6180	250-400	300-500								
	Alloyed Steel 4140, 4340	150-300	300-600	.005-.012							
	Tool Steel A-6, D-1, D-2	Up to 300									
Stainless Steel	300 Series, 304, 316	-	300-600	.005-.012	2	1	2		May not be required at high speeds		
	400 Series 15-5 PH	-	350-700								
	13-8 PH	-	200-400								
Nickel Alloys	Inconel 600, 706, 718, 903, Hastelloy, Waspalloy	-	75-150	.004-.008	1	2		Yes			
Titanium	6AL-4V, TI-10-2-3, TI-5553	-	75-200	.004-.008	2	1		Yes			

The success of any cutter application is a function of many variables. Our initial preference of grade is based on applying a more tough grade.

**STARTING FEED RATE GUIDELINES FOR EXTENDED FLUTE MILL
BASED ON WIDTH OF CUT**

Material	Material Specification	Radial WOC	Feed Rate (APT)			
			2.00 Diameter	2.50 Diameter	3.00 Diameter	4.00 Diameter
Aluminum	7075 - T6, 6061 - T6, 2024	0.02	0.050	0.060	0.070	0.080
		Diameter / 8	0.015	0.015	0.015	0.015
		Diameter / 4	0.012	0.012	0.012	0.012
		Diameter / 2	0.010	0.010	0.010	0.010
Cast Iron	Gray / Nodular	0.02	0.035	0.048	0.056	0.064
		Diameter / 8	0.009	0.011	0.011	0.011
		Diameter / 4	0.007	0.008	0.008	0.008
		Diameter / 2	0.006	0.006	0.006	0.006
Steel	Low / Med Carbon 1018, 1045, 8620	0.02	0.035	0.048	0.056	0.064
		Diameter / 8	0.009	0.011	0.011	0.011
		Diameter / 4	0.007	0.008	0.008	0.008
		Diameter / 2	0.006	0.006	0.006	0.006
	Alloyed Steel, 4140, 4340, Tool Steel A-6, D-1, D-2	0.02	0.030	0.042	0.049	0.056
		Diameter / 8	0.008	0.009	0.009	0.009
		Diameter / 4	0.006	0.007	0.007	0.007
		Diameter / 2	0.005	0.005	0.005	0.005
Stainless Steel	300 Series, 304, 316, 13-8PH	0.02	0.030	0.042	0.049	0.056
		Diameter / 8	0.008	0.009	0.009	0.009
		Diameter / 4	0.006	0.007	0.007	0.007
		Diameter / 2	0.005	0.005	0.005	0.005
	400 Series 15-5PH, 17-4PH	0.02	0.035	0.048	0.056	0.064
		Diameter / 8	0.009	0.011	0.011	0.011
		Diameter / 4	0.007	0.008	0.008	0.008
		Diameter / 2	0.006	0.006	0.006	0.006
Nickel Alloys & Titanium	Inconel, Hastelloy, Waspalloy, 6AL-4V	0.02	0.030	0.042	0.049	0.056
		Diameter / 8	0.008	0.009	0.009	0.009
		Diameter / 4	0.006	0.007	0.007	0.007
		Diameter / 2	0.005	0.005	0.005	0.005

The success of any cutter application is a function of many variables. Our initial preference of grade is based on applying a more tough grade.

FACE MILL OPERATING GUIDELINES

Series 2L1Q, 2J1Q, 2J1D		Brinell Hardness	SFM	Feed per Insert	Grades					Coolant
Material					IN30M/IN05S	IN2005	IN2505	IN1030	IN2030	
Aluminum	6061-T6, 7075-T6, 2024	-	1500-8000	.003-.008	1	2				Yes
Cast Iron	Gray	150-250	300-1000	.003-.008		1		2		No
	Nodular		300-600							
Steel	Low Carbon 1018, 8620	100-250	400-1000	.003-.008		2	1	1*	No	
	High Carbon F-6180, Nitalloy 52100	250-400	350-500	.003-.006						
	Alloyed Steel 4140, 4340, 6150	150-300	300-700	.003-.007	2	1	1*			
	Tool Steel A-6, D-1, D-2, P-20	Up to 300								
Stainless Steel	300 Series, 304, 316	-	300-700	.003-.006		2	1	1*	May not be required at high speeds	
	400 Series, 15-5 PH, 17-4 PH	-	400-900						Yes	
	13-8 PH	-	200-400							
Nickel Alloys	Inconel 600, 706, 718, 903, Hastelloy, Waspalloy	-	75-120	.003-.006		1	2	2	Yes	
Titanium	6AL-4V	-	100-150	.003-.006		2	1	1	Yes	

*Preferred for higher SFM.

Series 2J1E, 2J4E, 2L1E		Brinell Hardness	SFM	Feed per Insert	Grades						Coolant
Material					IN30M/IN05S	IN2005	IN2015	IN1030	IN2030	IN2040	
Aluminum	7075-T6, 6061-T6, 2024	-	1500-8000	.004-.018	1	3	2				Yes
Cast Iron	Gray	150-250	300-1000	.004-.018		2	1				No
	Nodular		300-600								
Steel	Low Carbon 1018-8620	100-250	400-1000	.004-.018	3	1	1*	2	No		
	High Carbon F-6180	250-400	350-500	.004-.015							
	Alloyed Steel 4140, 4340	150-300	300-700	.004-.018							
	Tool Steel A-6, D-1, D-2	Up to 300									
Stainless Steel	300 Series, 304, 316	-	300-700	.004-.018		2	3	1	1*	Yes	
	400 Series, 15-5 PH	-	400-900								
	13-8 PH	-	200-400								
Nickel Alloys	Inconel 600, 706, 718, 903, Hastelloy, Waspalloy	-	75-120	.003-.006		1	2	2	Yes		
Titanium	6AL-4V	-	100-150	.005-.008		2	1	1*	Yes		

*Preferred for higher SFM.

The success of any cutter application is a function of many variables. Our initial preference of grade is based on applying a more tough grade.

Series 2J1X, 2L1X, 2J1G, TFM90, 2J1B, 2J4B, 2L6B					Grades						Coolant
Material	Brinell Hardness	SFM	Feed per Insert	IN10K	IN2005/IN2305	IN2010/IN2510	IN1030	IN2030	IN2040	INDD15	
Aluminum	6061-T6, 7075-T6, 2024	-	1500-8000	.004-.010	1	3	2				Yes
Cast Iron	Gray	150-250	300-1000	.004-.010	3	1			2		No
	Nodular		300-600								
Steel	Low Carbon 1018, 8620	100-250	400-1000	.004-.010	2		1	1*	3		No
	High Carbon F-6180, Nitralloy 52100	250-400	350-500	.004-.008							
	Alloyed Steel 4140, 4340, 6150	150-300	300-700	.004-.010							
	Tool Steel A-6, D-1, D-2, P-20	Up to 300									
Stainless Steel	300 Series, 304, 316	-	300-700	.004-.010	2		1	1*	2		May not be required at high speeds
	400 Series, 15-5 PH, 17-4 PH	-	400-900								Yes
	13-8 PH	-	200-400								
Nickel Alloys	Inconel 600, 706, 718, 903, Hastelloy, Waspalloy	-	75-120	.003-.006	1	3	2	2			Yes
Titanium	6AL-4V	-	100-150	.005-.008	2		1	1			Yes

*Preferred for higher SFM.

Series 5J1E, 2J1F					Grades						Coolant
Material	Brinell Hardness	SFM	Feed per Insert	IN30M	IN2005	IN2015	IN1030/IN1530	IN2030	IN2040		
Aluminum	7075-T6, 6061-T6, 2024	-	1500-8000	.003-.008	1	3	2				Yes
Cast Iron	Gray	150-250	300-1000	.003-.008	2	1	3	3			No
	Nodular		300-600								
Steel	Low Carbon 1018-8620	100-250	400-1000	.003-.008	3		1	1*	2		No
	High Carbon F-6180	250-400	350-500	.003-.006							
	Alloyed Steel 4140, 4340	150-300	300-700	.003-.007							
	Tool Steel A-6, D-1, D-2	Up to 300									
Stainless Steel	300 Series, 304, 316	-	300-700	.003-.006	2		1	1*			May not be required at high speeds
	400 Series, 15-5 PH	-	400-900								Yes
	13-8 PH	-	200-400								
Nickel Alloys	Inconel 600, 706, 718, 903, Hastelloy, Waspalloy	-	75-120	.003-.006	2		1	1*			Yes
Titanium	6AL-4V	-	100-150	.003-.006	1		2	2			Yes

*Preferred for higher SFM.

The success of any cutter application is a function of many variables. Our initial preference of grade is based on applying a more tough grade.

FACE MILL OPERATING GUIDELINES

Series 5J1H		Material	Brinell Hardness	SFM	Feed per Insert	Grades					Coolant
						IN2005	IN1030	IN2015	IN2030	IN5015	
Aluminum	6061-T6, 7075-T6, 2024	-	1500-8000	.003-.008	2	1				Yes	
Cast Iron	Gray	150-250	300-1000	.003-.008	2	3	1	3	1	No	
	Nodular		300-600								
Steel	Low Carbon 1018, 8620	100-250	400-1000	.003-.008		1		1*		No	
	High Carbon F-6180, Nitralloy 52100	250-400	350-500	.003-.006				1*			
	Alloyed Steel 4140, 4340, 6150	150-300	300-700	.003-.007	2	1		1*			
	Tool Steel A-6, D-1, D-2, P-20	Up to 300									
Stainless Steel	300 Series, 304, 316	-	300-700	.003-.006	2	1		1*		May not be required at high speeds	
	400 Series, 15-5 PH, 17-4 PH	-	400-900								
	13-8 PH	-	200-400						Yes		
Nickel Alloys	Inconel 600, 706, 718, 903, Hastelloy, Waspalloy	-	75-120	.003-.006	1	2		2*		Yes	
Titanium	6AL-4V	-	100-150	.003-.006	2	1		1*		Yes	

*Preferred for higher SFM.

The success of any cutter application is a function of many variables. Our initial preference of grade is based on applying a more tough grade.

Series 5N6F, 5N2H		Material	Brinell Hardness	SFM	Feed per Insert	Grades						Coolant
						IN30M	IN200S	IN25T0	IN1030	IN2030	IN2040/IN2540	
Aluminum	7075-T6, 6061-T6, 2024	-	1500-8000	.004-.010	1	2					Yes	
Cast Iron	Gray	150-250	300-1000	.004-.010	2	1	3	3*			No	
	Nodular		300-600									
Steel	Low Carbon 1018-8620	100-250	400-1000	.004-.010	3	1	1*	2			No	
	High Carbon F-6180	250-400	350-500	.004-.008								
	Alloyed Steel 4140, 4340	150-300	300-700	.004-.010								
	Tool Steel A-6, D-1, D-2	Up to 300										
Stainless Steel	300 Series, 304, 316	-	300-700	.004-.010	2	1	1*			May not be required at high speeds		
	400 Series, 15-5 PH	-	400-900									
	13-8 PH	-	200-400									
Nickel Alloys	Inconel 600, 706, 718, 903, Hastelloy, Waspalloy	-	75-120	.003-.006	1	2	2			Yes		
Titanium	6AL-4V	-	100-150	.003-.006	2	1	1*			Yes		

*Preferred for higher SFM.

Series 5J2H		Material	Brinell Hardness	SFM	Feed per Insert	Grades		Coolant
						IN70N	IN72N	
Cast Iron	Gray	150-250	1800+	.005-.008	1	1		No
	Nodular		1500+	.004-.007				

The success of any cutter application is a function of many variables. Our initial preference of grade is based on applying a more tough grade.

FACE MILL OPERATING GUIDELINES

Series ON5H, ON6H, OP1N, OP6N					Grades*						Coolant
Material	Brinell Hardness	SFM	Feed per Insert	IN10K	IN20T0/IN25T0	IN20C30	IN2505/IN2005	IN20M0	IN20M4**	IN65T5	
Aluminum	6061 T-6, 7075 T-6, 2024	-	1500-8000	.006-.012	1						Yes
Cast Iron	Gray	150-250	500-1000	.008-.016	1				3	2	No
	Nodular		400-800	.007-.014	1				3	2	
Steel	Low Carbon 1018, 8620	100-250	400-1000	.006-.015							No
	High Carbon F-6180,	250-400	400-800	.006-.012		1	2	3			
	Alloyed Steel 4140, 4340	150-300	300-700								
	Tool Steel A-6, D-1, D-2	Up to 300	300-500								
Stainless Steel	300 Series, 304, 316	-	300-700	.005-.009		1	2	1			May not be required at high speeds
	400 Series 15-5 PH,	Up to 320	400-700								
	13-8 PH	-	200-400								Yes
Nickel Alloys	Inconel, Hastelloy, Waspalloy	-	75-120	.003-.006		2	1				Yes
Titanium	6AL-4V	-	100-150	.004-.007		1	2	2			Yes

*Preferred for higher SFM.
 **Preferred for CGI.

Series 5N6J, 5N6R					Grades						Coolant
Material	Brinell Hardness	SFM	Feed per Insert	IN15K/IN30M	IN2005	IN20T0/IN20T15	IN1030/IN1530	IN20M0	IN6530		
Aluminum	6061 T-6, 7075 T-6, 2024	-	1500-8000	.006-.020	1	2				Yes	
Cast Iron	Gray	150-250	300-1000	.006-.015		2	1	3		No	
	Nodular		300-600								
Steel	Low Carbon 1018, 8620	100-250	400-1000	.006-.015		3	1	2		No	
	High Carbon F-6180, Nitralloy 52100	250-400	350-600								
	Alloyed Steel 4140, 4340, 6150	150-300	300-800			2	1	3	4		
	Tool Steel A-6, D-1, D-2, P-20	Up to 300									
Stainless Steel	300 Series, 304, 316	-	300-700	.006-.015						Yes	
	400 Series, 15-5 PH, 17-4 PH	Up to 320	400-900			2	1				
	13-8 PH	-	200-400								
Nickel Alloys	Inconel 600, 706, 718, 903, Hastelloy, Waspalloy	-	75-120	.003-.010		1	2			Yes	
Titanium	6AL-4V	-	100-150	.003-.010		2	1			Yes	

The success of any cutter application is a function of many variables. Our initial preference of grade is based on applying a more tough grade.

Series 5N6H, 5N6K, 5N6L					Grades								Coolant
Material	Brinell Hardness	SFM	Feed per Insert	IN10K	IN30M	IN2005	IN2015	IN1030	IN2030	IN2040	IN1530	IN1540	
Aluminum	6061-T6, 7075-T6, 2024	-	1500-8000	.003-.007	1	1							Yes
Cast Iron	Gray	150-250	400-600	.003-.006	4	2	1	3	3	3	3		No
	Nodular		300-500										
Steel	Nitralloy Low Carbon 1018, 8620	100-250	400-1000	.003-.008			3	1	1*	2*	1	2	No
	High Carbon F-6180, 52100	250-400	400-600	.003-.007		2		1	1*	3	1	3	
	Alloyed Steel 4140, 4340, 6150	150-300	350-600										
	Tool Steel A-6, D-1, D-2, P-20	Up to 300											
Stainless Steel	300 Series, 304, 316	-	300-600	.003-.006		2	1	1*		1			May not be required at high speeds
	400 Series, 15-5 PH, 17-4 PH	Up to 320											Yes
	13-8 PH	-											
Nickel Alloys	Inconel 600, 706, 718, 903, Hastelloy, Waspalloy	-	70-100	.002-.004			1	2	2	1			Yes
Titanium	6AL-4V	-	100-150	.003-.005			2	1	1*	2			Yes

*Preferred for higher SFM.

Series 5H6G, 5X6Z, 5X6X, 5X6W					Grade	Coolant
Material	Brinell Hardness	SFM	Feed per Insert	IN15K		
Aluminum	7075-T6, 6061-T2, 2024	-	2000-15000	.008-.025	1	Yes

The success of any cutter application is a function of many variables. Our initial preference of grade is based on applying a more tough grade.

FACE MILL OPERATING GUIDELINES

Series DN5H/DN6H, DL5H/DL6H, DJ5H/DJ6H					Grades					Coolant
Material	Brinell Hardness	SFM	Feed per Insert	IN70K	IN2010/IN2510	IN2030	IN2505	IN62C	INDD15	
Aluminum	7075 - T6, 6061 - T6, 2024	-	1500-8000	.004-.020	1					Yes
Cast Iron	Gray	150-250	300-1000	.006-.018	1			W	2	No
	Nodular		300-600	.006-.018	1			W	2	No
Steel	Low Carbon 1018, 8620	100-250	400-1000	.006-.018		1	2			No
	High Carbon F-6180	250-400	350-500	.006-.015						No
	Alloyed Steel 4140, 4340	150-300	300-800	.006-.018						No
	Tool Steel A-6, D-1, D-2	Up to 300								
Stainless Steel	300 Series, 304, 316	-	300-700	.004-.008		1	2			May not be required at high speeds
	400 Series 15-5 PH	Up to 320	400-700							Yes
	13-8 PH	-	200-400							
Nickel Alloys	Inconel, Hastelloy, Waspalloy	-	75-120	.003-.006		2	1			Yes
Titanium	6AL-4V	-	100-150	.004-.006		1	2			Yes

W=WIPER

Series DJ6T, DJ5T					Grades					Coolant
Material	Brinell Hardness	SFM	Feed per Insert	IN2010	IN2030	IN2505	IN2540	INDD15		
Cast Iron	Gray	150-250	500-1000	.008-.010	2				1	No
	Nodular		400-800	.007-.009	1				2	
Steel	Low Carbon 1018, 8620	100-250	400-1000	.006-.012		1	3	2		No
	High Carbon F-6180	250-400	400-800	.006-.010						
	Alloyed Steel 4140, 4340	150-300	300-700							
	Tool Steel A-6, D-1, D-2	Up to 300	300-500							
Stainless Steel	300 Series, 304, 316	-	300-700	.005-.008		1	2			May not be required at high speeds
	400 Series, 15-5 PH	Up to 320	400-700							Yes
	13-8 PH	-	200-400							
Nickel	Inconel, Hastelloy, Waspalloy	-	75-120	.003-.006		2	1			Yes
Titanium	6AL-4V	-	100-150	.004-.007		1	2			Yes

*Preferred for higher SFM.

The success of any cutter application is a function of many variables. Our initial preference of grade is based on applying a more tough grade.

Series 6X1V, 6X2V, 6X3V, 6X4V

Material	Material	Brinell Hardness	SFM	Feed per Insert	Grades		Coolant
					IN10K	IN9DD	
Aluminum	6061 T-6, 7075 T-6	-	1500-8000	.004-.015	2	1	Yes
Cast Iron	Gray	150-250	300-1000	.004-.012	1	2	Yes
	Nodular		300-600				

Series DM5G, DM6G

Material	Material	Brinell Hardness	SFM	Feed per Insert	Grades							Coolant	
					IN05S	IN1030	IN2005/IN2505	IN2015	IN2030	INDD15	IN70N		
Aluminum	7075-T6, 6061-T6, 2024	-	1000-8000	.005-.020	1		3	2					Yes
Cast Iron	Grey	150-250	300-1000	.008-.020			3	2			1		No
			1800+	.005-.008							1		
	Nodular	150-250	300-600	.008-.015			3	1		2			No
			1500+	.004-.007							1		
Steel	Low Carbon 1018, 8620	150-250	400-1000	.008-.020									No
	High Carbon F-6180	250-400	350-500	.008-.015									
	Alloyed Steel 4140, 4340	150-300	300-700	.008-.020	1	2		1*	2				
	Tool Steel A-6, D-1, D-2	Up to 300											
Stainless Steel	300 Series, 304, 316	-	300-700										May not be required at high speeds
	400 Series, 15-5 PH	Up to 320	400-900	.007-.015	1	2		1*					
	13-8 PH	-	200-400									Yes	
Nickel	Inconel, Hastelloy, Waspalloy	-	75-120	.004-.012			1	2				Yes	
Titanium	6AL-4V	-	100-150	.005-.014			2	1				Yes	

*Preferred for higher SFM.

Series SJ2R, SN2R

Material	Material	Brinell Hardness	SFM	Feed per Insert	Grades						Coolant	
					IN2030	IN2005	IN2015/IN6515	IN1530	IN2040	IN6530		
Cast Iron	Gray	150-280	400-750	.008-.030			2	1				No
	Nodular		300-650									
Steel	Low Carbon 1018, 8620	100-250	250-500	.008-.025								No
	High Carbon F-6180	250-400	200-350	.008-.020								
	Alloyed Steel 4140, 4340	150-300	250-400	.008-.025	2	1		2	3	3		
	Tool Steel A-6, D-1, D-2	Up to 300										
Stainless Steel	300 Series, 304, 316	-	250-400									May not be required at high speeds
	400 Series, 15-5 PH	Up to 300	300-600	.006-.014	1	2		1				
	13-8 PH	-	200-250								Yes	
Nickel Alloys	Inconel 600, 706, 718, 903, Hastelloy, Waspalloy	-	75-150	.004-.007	2	1		2			Yes	

The success of any cutter application is a function of many variables. Our initial preference of grade is based on applying a more tough grade.

FACE MILL OPERATING GUIDELINES

Series SF6H, SF6N		Brinell Hardness	SFM	Feed per Insert	Grades			Coolant
Material					IN1505	IN1510	IN1540	
Aluminum	7075-T6, 6061-T6, 2024	-	1000-8000	.020-.050	1	2		Yes
Cast Iron	Gray	150-250	1000-1500	.010-.050		1		No
	Nodular							
Steel	Low Carbon 1018, 8620	100-250	800-1200	.010-.050	1	2	2	No
	High Carbon F-6180	250-400	500-800					
	Alloyed Steel 4140, 4340	150-300	600-1000					
	Tool Steel A-6, D-1, D-2	Up to 300						
Stainless Steel	300 Series, 304, 316	-	400-600	.010-.050	1		2	No
	400 Series, 15-5 PH	Up to 320	500-800					
	13-8 PH	-	400-600					
Nickel Alloys	Inconel 600, 706, 718, 903, Hastelloy, Waspalloy	-	75-150	.010-.030	1			Yes
Titanium	6AL-4V	-	100-200	.010-.030	1			Yes

Series SJ2N, SJ6N, SN2N, SN6N, 2SJ1N, VM2N		Brinell Hardness	SFM	Feed per Insert	Grades						Coolant
Material					IN2005	IN2015/IN6510	IN1530	IN2040	IN6515	IN2030	
Cast Iron	Gray	150-280	400-750	.007-.018	3	1			2		No
	Nodular		300-650								
Steel	Low Carbon 1018, 8620	100-250	250-500	.005-.015	1		3	2		2	No
	High Carbon F-6180	250-400	200-350								
	Alloyed Steel 4140, 4340	150-300	250-400								
	Tool Steel A-6, D-1, D-2	Up to 300									
Stainless Steel	300 Series, 304, 316	-	250-400	.005-.010	2		1		1	May not be required at high speeds	
	400 Series, 15-5 PH	Up to 300	300-600							Yes	
	13-8 PH	-	200-250							.006-.012	
Nickel Alloys	Inconel 600, 706, 718, 903, Hastelloy, Waspalloy	-	75-150	.004-.007	1		2		2	Yes	
Titanium	6AL-4V	-	100-150	.004-.007	2		1		1	Yes	

The success of any cutter application is a function of many variables. Our initial preference of grade is based on applying a more tough grade.

Series DJ1H		Material	Brinell Hardness	SFM	Feed per Insert	Grades			Coolant
						IN2305	IN2010	IN80B	
Cast Iron	Gray	150-250	300-1000	.006-.012	1			No	
			1800 +	.005-.008		1		No	
	Nodular	150-250	300-600	.005-.011	1			No	
			1500 +	.004-.007		1		No	
Steel	-	-	500-1000	.004-.008	1			No	
Stainless Steel	-	-	500-1000	.004-.008	1			No	

Series SJ6H, SJ5E		Material	Brinell Hardness	SFM	Feed per Insert	Grades				Coolant
						IN2205	IN2015/IN2010	IN1530	IN2040	
Cast Iron	Gray	150-280	400-750	.003-.006			1		No	
	Nodular		300-650						No	
Steel	Low Carbon 1018, 8620	100-250	250-500	.003-.006					No	
	High Carbon F-6180	250-400	200-350	.003-.005	1	3	2	2		
	Alloyed Steel 4140, 4340	150-300	250-400							
	Tool Steel A-6, D-1, D-2	Up to 300								
Stainless Steel	300 Series, 304, 316	-	400-600	.003-.006	1	3	2		May not be required at high speeds	
	400 Series, 15-5 PH	Up to 320	300-600						Yes	
	13-8 PH	-	200-600							
Nickel Alloys	Inconel 600, 706, 718, 903, Hastelloy, Waspalloy	-	75-150	.003-.005	1		2		Yes	
Titanium	6AL-4V	-	100-200	.003-.005	2		1		Yes	

The success of any cutter application is a function of many variables. Our initial preference of grade is based on applying a more tough grade.

FACE MILL OPERATING GUIDELINES

Series SJ5V, SJ6V		Brinell Hardness	SFM	Feed per Insert	Grades			Coolant
Material					IN2005	IN2015	IN2030	
Aluminum	7075-T6, 6061-T6, 2024	-	1500-8000	.003-.007	1	2	Yes	
Cast Iron	Gray	150-280	400-750	.003-.006	2	1	No	
	Nodular		300-650					
Steel	Low Carbon 1018, 8620	100-250	250-500	.003-.006	1	2	No	
	High Carbon F-6180	250-400	200-350					
	Alloyed Steel 4140, 4340	150-300	250-400	.003-.005				
	Tool Steel A-6, D-1, D-2	Up to 300						
Stainless Steel	300 Series, 304, 316	-	400-600	.003-.006	2	1	May not be required at high speeds	
	400 Series, 15-5 PH	Up to 320	300-600					
	13-8 PH	-	200-600				Yes	
Nickel Alloys	Inconel 600, 706, 718, 903, Hastelloy, Waspalloy	-	75-150	.003-.005	1	2	Yes	
Titanium	6AL-4V	-	100-200	.003-.005	2	1	Yes	

Series DM5Q, DM6Q, DM2Q		Brinell Hardness	SFM	Feed per Insert	Grades				Coolant			
Material					IN2005	IN2030	IN2040	INDD15				
Cast Iron	Gray	150-250	300-1000	.007-.025	2			1	No			
	Nodular		300-600							.007-.020	2	
Steel	Low Carbon 1018-8620	150-250	400-1000	.008-.025	3	2	1		No			
	High Carbon F-6180	250-400	350-500							.008-.020		
	Alloyed Steel 4140, 4340	150-300	300-700	.008-.020							3	1
	Tool Steel A-6, D-1, D-2	Up to 300										
Stainless Steel	300 Series, 304, 316	-	250-600	.007-.018	2	1			May not be required at high speeds			
	400 Series 15-5 PH	Up to 320	300-600									
	13-8 PH	-	200-550						Yes			

The success of any cutter application is a function of many variables. Our initial preference of grade is based on applying a more tough grade.

Series VM6V, VL6V, VK6V, VK5V					Grades								Coolant
Material	Material	Brinell Hardness	SFM	Feed per Insert	IN15K	IN2005	IN2015/IN2010	IN1530	IN2030	IN2040	IN6515	IN70N	
Aluminum	6061-T6, 7075-T6, 2024	-	1500-8000	.004-.015	1								Yes
Cast Iron	Gray	150-280	400-750	.005-.012	3	1				2			No
	Nodular		300-650										
			1500+	.004-.007									
Steel	Low Carbon 1018, 8620	100-250	250-500	.005-.010	2			2	1				No
	High Carbon F-6180, Nitralloy 52100	250-400	200-350	.005-.008									
	Alloyed Steel 4140, 4340, 6150	150-300	250-400	.005-.010									
	Tool Steel A-6, D-1, D-2, P-20	Up to 300											
Stainless Steel	300 Series, 304, 316	-	250-400	.003-.006	1		2	2					May not be required at high speeds
	400 Series, 15-5 PH, 17-4 PH	Up to 320	300-600										Yes
	13-8 PH	-	200-250										.004-.008
Nickel Alloys	Inconel 600, 706, 718, 903, Hastelloy, Waspalloy	-	75-120	.003-.006	1		1	2					Yes
Titanium	6AL-4V	-	100-150	.003-.006	2		1	1					Yes

*Preferred for higher SFM.

The success of any cutter application is a function of many variables. Our initial preference of grade is based on applying a more tough grade.

CONTOUR MILLING OPERATING GUIDELINES

Series 12W9, 12W5					Grades			Coolant
Material	Brinell Hardness	SFM	Feed per Insert	IN2005	IN2006	IN035		
Aluminum	6061 T-6, 7075 T-6	-	1000-8000	.003-.006	2		1	Yes
Cast Iron	Gray	150-250	500-1200	.002-.006	1			No
	Nodular	150-250	400-800	.002-.006	1			
Steel	Low Carbon 1018-8620	150-250	600-1200	.002-.006	1			No
	High Carbon F-6180	250-400*	400-600	.002-.005	2	1		
	Alloyed Steel 4140	150-300	400-800	.002-.005	1	2		
	Tool Steel P-20-H13	Up to 460*	400-800	.002-.005	2	1		
Stainless Steel	300 Series, 304, 316	-	400-800	.002-.005	1	2		No
	400 Series, 15-5 PH, 17-4 PH	Up to 320	500-1000	.002-.005	1	2		
	13-8 PH	-	200-400	.002-.005	1	2		
Nickel Alloys	Inconel 600, 706, 718, 903, Hastelloy	75-120	75-120	.002-.004	1	2		Yes
Titanium	6AL-4V	-	80-150	.002-.005	1	2		Yes

*58Rc & Above use IN2006.

Series 15V1E, 5V6E, 1TG1F, TG1F					Grades				Coolant
Material	Brinell Hardness	SFM	Feed per Insert	IN2005/IN2505	IN2030	IN2040/IN2540	IN0530		
Steel	Mild 1018-1045	125-425	500-1100	.010-.035		1	2	2	No
	Low Alloy 4140, 8620, 4340	150-425	400-1000	.008-.018	1	3	2	4	
	Med Alloy P20, S7, H13, O1, A2	150-425	300-900		1	2		3	
	High Alloy A7-D2	200-425	300-600	.005-.015	1	2		3	
Stainless Steel	Free Machining 303, 416	150-425	300-800	.010-.030	2	1		3	No
	300 Series 304, 310, 316	150-425	200-600	.005-.015					
	400 Series 410, 420, 15-5PH, 17-4 PH	150-425	200-600						
	PH Series 13-8	150-425	200-500						
Hardened Steel	ALL		200-400	.002-.010	1		2	3	No

The success of any cutter application is a function of many variables. Our initial preference of grade is based on applying a more tough grade.

Series 15V1H, 5V6H					Grades			Coolant
Material	Brinell Hardness	SFM	Feed per Insert	IN2005	IN2030	IN2040		
Steel	Mild 1018-1045	125-425	500-1100	.015-.035				No
	Low Alloy 4140, 8620, 4340	150-425	400-1000	.010-.025	1	3	2	
	Med Alloy P20, S7, H13, O1, A2	150-425	300-900					
	High Alloy A7-D2	200-425	300-600	.005-.020	1	2		
Stainless Steel	Free Machining 303, 416	150-425	300-800	.010-.030	1	2		No
	300 Series 304, 310, 316	150-425	200-600	.005-.030				
	400 Series 410, 420, 15-5PH, 17-4 PH	150-425	200-600					
	PH Series 13-8	150-425	200-500					
Hardened Steel	ALL		200-400	.002-.010	1	2	No	

Series 15V1Z, 5V6G, 15V1D, 15V1G					Grades				
Material	Brinell Hardness	SFM	Feed per Insert	IN2005*	IN2005	IN1030	IN2040	IN3005**	
Steel	Alloyed Steel 4140, 4340	150-300	500-10000	.003-.006	1	3	2		No
	Tool Steel A-6, D-1, D-2	Up to 300							
Stainless Steel	300 Series, 304, 316	-	300-700	.003-.006	1	2	3		No
	400 Series, 15-5 PH	Up to 320	400-900	.003-.006	1	2	3		Yes
	13-8 PH	-	200-400	.003-.006	1	2	3		No

*Preferred for hardened steel RC58-62.

**Preferred for milling graphite.

The success of any cutter application is a function of many variables. Our initial preference of grade is based on applying a more tough grade.

CONTOUR MILLING OPERATING GUIDELINES

Series DG6H, 1DG1H, 1DP1G, DP5G						Grades			
Material	Brinell Hardness	SFM	Feed per Insert	IN2005	IN2505	IN2030	IN6530	IN2340	Coolant
Steel	Mild 1018-1045	125-425	300-650	.035-.157	1				No
	Low Alloy 4140, 8620, 4340	150-425				2	1	3	
	Med Alloy P20, S7, H13, O1, A2		300-700						
Stainless Steel	Free Machining 303, 416	150-425	200-550	.030-.100	1	2	3	4	Yes
	300 Series 304, 310, 316								
	400 Series 410, 420, 15-5PH, 17-4 PH								
	PH Series 13-8								
Hardened Steel	ALL	-	200-400	.030-.075	1	2			No

Series SP6H/SP6N							Grades			
Material	Brinell Hardness	SFM	Feed per Insert	DOC		IN2005	IN1530	IN2030	IN2015	Coolant
				DPM324L	DPM434L					
Steel	Low Carbon 1018, 8620	100-250	500-800	.035-.100	.040-.080	.060-.120	1	2	2	No
	High Carbon F-6180	250-400	400-700							
	Alloyed Steel 4140, 4340	150-300	300-600							
	Tool Steel A-6, D-1, D-2	Up to 300								
Stainless Steel	300 Series, 304, 316	-	300-600	.030-.080	.030-.080	.050-.100	1	2	3	May not be required at high speeds.
	400 Series 15-5 PH	Up to 320	300-500							
	13-8 PH	-	200-400							
Titanium	6AL-4V	-	100-200	.030-.060	.030-.070	.040-.100	2	1		Yes

The success of any cutter application is a function of many variables. Our initial preference of grade is based on applying a more tough grade.

Series 15W7V, 25W1V		Brinell Hardness	SFM	Feed per Insert	Grades			Coolant
Material					IN30M	IN1030		
Aluminum	7075-T6, 6061-T2, 2024	-	1500-8000	.003-.008	2	1	Yes	
Cast Iron	Gray	150-250	300-1000	.003-.008		1	No	
	Nodular		300-600					
Steel	Low Carbon 1018, 8620	150-250	400-1000	.003-.008		1	No	
	High Carbon F-6180	250-400	350-500	.003-.006		1		
	Alloyed Steel 4140, 4340	150-300	300-700	.003-.008		1		
	Tool Steel A-6, D-1, D-2, P-20	Up to 300						
Stainless Steel	300 Series, 304, 316	-	300-700	.003-.006		1	Yes	
	400 Series 15-5 PH	Up to 320	400-900					
	13-8 PH	-	200-400					
Nickel Alloys	Inconel 600, 706, 718, 903, Hastelloy, Waspalloy	-	75-120	.003-.006	2	1	Yes	
Titanium	6AL-4V	-	100-150	.003-.006	2	1	Yes	

Series 13W7X, 23W1X		Brinell Hardness	SFM	Feed per Insert	Grades			Coolant	
Material					IN40P	IN1530	IN1540		
Cast Iron	Gray GM-241M, M3A71-A G2500	150-250	600-900	.015-.025	3	1	2	No	
	Nodular GM-245M		500-800						
Steel	Low Carbon 1018-8620	150-250	500-800	.010-.020	3	2	1	No	
	Cast Steel GM-190M, M3A76-A								
	Alloyed Steel 4140, 4340, 6150								150-300
	Tool Steel A-6, D-1, D-2, P-20, W2								Up to 300
Stainless Steel	300 Series, 304, 316	-	300-500	.008-.015		1	Yes		
	400 Series 15-5 PH, 17-4 PH	Up to 320							
	13-8 PH	-	250-350						

The success of any cutter application is a function of many variables. Our initial preference of grade is based on applying a more tough grade.

CONTOUR MILLING OPERATING GUIDELINES

Series 15B		Material	Brinell Hardness	SFM	RPLT, RPLH, (RPLP)	RPLW, (RPLB)	Feed per Insert			Grades								Coolant
							RPLW, RPLB, (RPLS)	RPCW, (RPCB)		IN05S/IN10K	IN1530/IN6530	IN2030	IN2040	IN1540	IN2015/IN6515	IN2005/IN2505	IN2004*	
Aluminum	6061 T-6, 7075 T-6	-	1500-8000	.005-.015	-	-	.005-.015	1										Yes
Cast Iron	Gray	150-250	250-800	.005-.015	.008-.020	-	.005-.015	2	3			1	3					No
	Nodular		200-800															
Steel	Low Carbon 1018-8620	100-250	250-1000	.005-.015	.008-.020	-	.005-.015			1	1	3	5	4	2			No
	High Carbon F-6180, Nitralloy 52100	250-400	200-750															
	Alloyed Steel 4140, 4340, 6150	150-300	250-750															
	Tool Steel A-6, D-1, D-2, P-20	Up to 300	250-750															
Stainless Steel	300 Series, 304, 316	-	250-750	.005-.015	.005-.015	.005-.015	.005-.015	2	1	4		3	2					Yes
	400 Series 15-5 PH, 17-4 PH	Up to 320	300-800															
	13-8 PH	-	200-600															
Nickel Alloys	Inconel 600, 706, 718, 903, Hastelloy, Waspalloy	-	75-120	.005-.008	-	.003-.006	.003-.006	1	2									Yes
Titanium	6AL-4V	-	100-150	.005-.010	-	.005-.008	.005-.008	2	1			3	2					Yes

*Preferred for CGI
 **Preferred for milling hardened steel RC58-62

Series 1DB1H, DW_H, TFMR, TBRP		Material	SFM	Feed per Insert	Depth of Cut	Grade	Coolant
		Inconel	985 - 2600	.002 - .004	.040 - .120	IN72N	No
		Ductile Cast Iron	1970 - 2600	.004 - .012	.040 - .157	X	No

The success of any cutter application is a function of many variables. Our initial preference of grade is based on applying a more tough grade.

Series 5W7		Material	Brinell Hardness	SFM	Feed per Insert	Grades						Coolant
						IN05S	IN2004	IN2005	IN2015	IN2030	IN2040	
Aluminum	6061-T6, 7075-T6	-	1500-8000	.010-.025	1							Yes
Cast Iron	Gray	150-250	250-800	.008-.025			2	1	3			No
	Nodular		200-800									
Steel	Low Carbon 1018-8620	150-250	250-1000	.008-.025			3	1	2			No
	High Carbon F-6180	250-400	200-750									
	Alloyed Steel 4140	150-300	150-300			2			1	3	*	
	Tool Steel P20-H13	Up to 300	Up to 300									
Stainless Steel	300 Series, 304, 316	-	250-750	.007-.018			2	3	1	4		Yes
	400 Series 15-5 PH, 17-4 PH	Up to 320	300-800									
	13-8 PH	-	200-600									
Nickel Alloys	Inconel 600, 706, 718, 903, Hastelloy	-	75-120	.005-.015			2		1			Yes
Titanium	6AL-4V	-	100-150	.004-.015			2		1			Yes

*Preferred for milling hardened steel RC58-62.

Series 5W		Material	Brinell Hardness	SFM	Feed per Insert		Grades						Coolant
					RPLT, RPLH, (RNLM, RPLP)	RPLW, (RPLB)	IN40P	IN1530	IN2030	IN2040	IN1540	IN6330	
Aluminum	6061 T-6, 7075 T-6	-	1500-8000	.005-.015	-			1				2	Yes
Cast Iron	Gray	150-250	250-800	.005-.015	.008-.020			2	3	4		1	No
	Nodular		200-800										
Steel	Low Carbon 1018, 8620	100-250	250-1000	.005-.015	.008-.020	6	1	2	3	5	4	No	
	High Carbon F-6180, Nitralloy 52100	250-400	200-750										
	Alloyed Steel 4140, 4340, 6150	150-300	250-750				6	5	3	2	4		1
	Tool Steel A-6, D-1, D-2, P-20	Up to 300											
Stainless Steel	300 Series, 304, 316	-	250-750	.005-.015	.005-.015			2	1	4		3	May not be required at high speeds
	400 Series, 15-5 PH, 17-4 PH	Up to 320	300-800										Yes
	13-8 PH	-	200-600										
Nickel Alloys	Inconel 600, 706, 718, 903, Hastelloy, Waspalloy	-	75-120	.005-.008	-		1	2			3	Yes	
Titanium	6AL-4V	-	100-150	.005-.010	-		2	1			3	Yes	

The success of any cutter application is a function of many variables. Our initial preference of grade is based on applying a more tough grade.

CONTOUR MILLING OPERATING GUIDELINES

Series 15W, 5W6		Brinell Hardness	SFM	Feed per Insert	Grades			Coolant
Material					IN2030	IN2040	IN6530	
Aluminum	6061-T6, 7075-T6	-	1500-8000	.012-.035	1	3	2	Yes
Cast Iron	Gray	150-250	250-800	.010-.025	1	2	3	No
	Nodular		200-800					
Steel	Low Carbon 1018-8620	150-250	250-1000	.010-.025	3	2	1	No
	High Carbon F-6180	250-400	200-750					
	Alloyed Steel 4140	150-300	150-300					
	Tool Steel P20-H13	Up to 300	Up to 300					
Stainless Steel	300 Series, 304, 316	-	250-750	.005-.015	1	2	Yes	
	400 Series 15-5 PH, 17-4 PH	Up to 320	300-800					
	13-8 PH	-	200-600					
Nickel Alloys	Inconel 600, 706, 718, 903, Hastelloy	-	75-120	.005-.008	1	2	Yes	
Titanium	6AL-4V	-	100-150	.005-.010	1			Yes

Series VHU		Brinell Hardness	SFM	Feed per Insert	Grades					Coolant
Material					IN2015/IN2010	IN1530	IN2030	IN2040	IN6515/IN6510	
Aluminum	6061-T6, 7075-T6, 2024	-	1500-8000	.004-.015	1					Yes
Cast Iron	Gray	150-280	400-750	.005-.012	1			2		No
	Nodular		300-650							
			1500+							
Steel	Low Carbon 1018, 8620	100-250	250-500	.005-.010	3	2	1			No
	High Carbon F-6180, Nitralloy 52100	250-400	200-350	.005-.008						
	Alloyed Steel 4140, 4340, 6150	150-300	250-400	.005-.010						
	Tool Steel A-6, D-1, D-2, P-20	Up to 300								
Stainless Steel	300 Series, 304, 316	-	250-400	.003-.006	1	2				May not be required at high speeds
	400 Series, 15-5 PH, 17-4 PH	Up to 320	300-600							
	13-8 PH	-	200-250							.004-.008
Nickel Alloys	Inconel 600, 706, 718, 903, Hastelloy, Waspalloy	-	75-120	.003-.006	1	2			Yes	
Titanium	6AL-4V	-	100-150	.003-.006	2	2			Yes	

The success of any cutter application is a function of many variables. Our initial preference of grade is based on applying a more tough grade.

Series SHU		Material	Brinell Hardness	SFM	Feed per Insert	Grades			Coolant
						IN2005	IN1530		
Cast Iron	Gray	150-280	400-750	.007-.018	1			No	
	Nodular		300-650						
Steel	Low Carbon 1018, 8620	100-250	250-500	.005-.015	1	2		No	
	High Carbon F-6180	250-400	200-350	.006-.013					
	Alloyed Steel 4140, 4340	150-300	250-400	.006-.015					
	Tool Steel A-6, D-1, D-2	Up to 300							
Stainless Steel	300 Series, 304, 316	-	250-400	.005-.010	2	1		May not be required at high speeds	
	400 Series, 15-5 PH	Up to 300	300-600					Yes	
	13-8 PH	-	200-250					.006-.012	Yes
Nickel Alloys	Inconel 600, 706, 718, 903, Hastelloy, Waspalloy	-	75-150	.004-.007	2	1		Yes	
Titanium	6AL-4V	-	100-150	.004-.007	2	1		Yes	

Series DHU		Material	Brinell Hardness	SFM	Feed per Insert	Grades						Coolant
						IN30M	IN1030/IN1530	IN2005	IN6515	IN6530	IN6520	
Aluminum	6061 T-6, 7075 T-6	-	1500-8000	.004-.010	1	2						No
Cast Iron	Gray	150-250	250-800	.005-.012		2	1	3	4			No
	Nodular		200-800									
Steel	Low Carbon 1018-8620	100-250	250-800	.004-.012		1	2					No
	High Carbon F-6180, Nitalloy 52100	250-400	200-700	.005-.012								
	Alloyed Steel 4140, 4340, 6150	150-300	250-700		1	2		2	3			
	Tool Steel A-6, D-1, D-2, P-20	Up to 300										
Stainless Steel	300 Series, 304, 316	-	250-600	.004-.008								Yes
	400 Series 15-5 PH, 17-4 PH	Up to 320	300-700	.005-.010	1	2	1	3	4			
	13-8 PH	Up to 320	200-250	.004-.008								
Nickel Alloys	Inconel 600, 706, 718, 903, Hastelloy, Waspalloy	-	75-120	.004-.008	1	2	1		3		Yes	
Titanium	6AL-4V	-	100-150	.004-.008	1	2			3		Yes	

The success of any cutter application is a function of many variables. Our initial preference of grade is based on applying a more tough grade.

CONTOUR MILLING OPERATING GUIDELINES

Series 5E6, 15E1		Brinell Hardness	SFM	Feed per Insert			Grades					Coolant
				CC/CC1/CC2	CP	PH/PH2	IN2005	IN2015	IN2030	IN05S	IN2040	
Material												
Aluminum	6061 T-6, 7075 T-6	-	1600-3300	-	.007-.012	-				1		Yes
Cast Iron	Gray	150-250	500-800	.007-.010	-	.015-.039	2	1				No
	Nodular		450-800									
Steel	Low Carbon 1018-8620	150-250	500-700	.007-.012	-	.015-.039	1	3	2			No
	High Carbon F-6180	250-400	450-500	.007-.010	-	.015-.039	1	3	2		3	
	Alloyed Steel 4140	150-300										
	Tool Steel P20-H13	up to 300										
Stainless Steel	300 Series, 304, 316	up to 320	250-500	.006-.010	-	.011-.023	2	3	1			Yes
	400 Series, 15-5 PH, 17-4 PH											
	13-8 PH											
Nickel Alloys	Inconel 600, 706, 718, 903, Hastelloy	-	50-250	.006-.010	-	.011-.023	2	3	1			Yes
Titanium	6AL-4V	-	50-250	.006-.010	-	.009-.015	2		1			Yes

Recommended Starting Ranges

The success of any cutter application is a function of many variables. Our initial preference of grade is based on applying a more tough grade.

Series 1BW, 2BW					Grades				
Material		Brinell Hardness	SFM	Feed per Insert	IN2005	IN2015/IN6515	IN2030	IN2040	Coolant
Aluminum	6061 T-6, 7075 T-6	-	1000-3000	.003-.008	1				Yes
Cast Iron	Gray	150-250	500-1200	.002-.008	2	1			No
	Nodular	150-250	400-800	.002-.008					
Steel	Low Carbon 1018-8620	150-250	600-1200	.005-.020	2		1	3	No
	High Carbon F-6180	250-400	400-600	.005-.020					
	Alloyed Steel 4140	150-300	400-800	.005-.025					
	Tool Steel P-20-H13	Up to 460	400-800	.005-.025					
Stainless Steel	300 Series, 304, 316	-	400-800	.003-.015	2		1	3	No
	400 Series 15-5 PH, 17-4 PH	Up to 320	500-1000	.003-.015					Yes
	13-8 PH	-	200-400	.003-.015					
Nickel Alloys	Inconel 600, 706, 718, 903 Hastelloy	75-120	75-120	.003-.010	2			1	Yes
Titanium	6AL-4V	-	80-150	.002-.006	2			1	Yes

Note: Feed and speed recommendations are starting operating parameters. They are only guidelines from which further optimization should take place. Operating parameters are influenced by many machining variables. These variables may cause for reductions in feeds and speed or dramatic increases. Additionally, DOC and WOC may need to be revised to optimize the tools performance.

The success of any cutter application is a function of many variables. Our initial preference of grade is based on applying a more tough grade.

SLOTTER OPERATING GUIDELINES

Series 31J, TSC_K, TSC_A

Material	Brinell Hardness	SFM	Feed per Insert by Width				Coolant		
			.063	.122	.188	.250			
Aluminum	7075-T6, 6061-T2, 2024	-	1300-8000	.001-.004	.0015-.007	.0025-.009	.0025-.010	1	Yes
Cast Iron	Gray	150-250	200-400	.001-.004	.0015-.007	.0025-.009	.0025-.010	1	No
	Nodular		200-330						
Steel	Low Carbon 1018-8620	150-250	600-1200	.001-.004	.0015-.007	.0025-.009	.0025-.010	1	No
	High Carbon F-6180	250-400	400-600						
	Alloyed Steel 4140, 4340	150-300	350-800						
	Tool Steel A-6, D-1, D-2	Up to 300	350-800						
Stainless Steel	300 Series, 304, 316	-	400-850	.001-.004	.0015-.007	.0025-.009	.0025-.010	1	Yes
	400 Series, 15-5 PH	Up to 320	460-800						
	13-8 PH	-	115-330						
Nickel Alloys	Inconel 600, 706, 718, 903, Hastelloy, Waspalloy	-	70-200	.001-.004	.0015-.007	.0025-.009	.0025-.010	1	Yes
Titanium	6AL-4V	-	115-200	.001-.004	.0015-.007	.0025-.009	.0025-.010	1	Yes

Series 35J, 38L

Material	Brinell Hardness	SFM	Feed per Insert	Grades						Coolant	
				IN30M	IN2005	IN2015	IN1030	IN2030	IN2040		
Aluminum	6061 T-6, 7075 T-6	-	1500-8000	.004-.015	1	3			2		Yes
Cast Iron	Gray	150-250	250-400	.003-.008			1	2	3		No
	Nodular		200-350								
Steel	Low Carbon 1018-8620	100-250	250-600	.003-.008							No
	High Carbon F-6180, Nitr alloy 52100	250-400	200-350	.005-.010	2	1	1	3			
	Alloyed Steel 4140, 4340, 6150	150-320	250-400								
	Tool Steel A-6, D-1, D-2, P-20	Up to 320									
Stainless Steel	300 Series, 304, 316	Up to 320	200-350	.005-.010	3	2	1				Yes
	400 Series 15-5 PH, 17-4 PH	Up to 320	200-500								
	13-8 PH	Up to 320	120-250								
Nickel Alloys	Inconel 600, 706, 718, 903, Hastelloy, Waspalloy	Up to 320	75-180	.003-.006	2		1	2			Yes
Titanium	6AL-4V	Up to 320	100-150	.004-.008	2		1	1			Yes

The success of any cutter application is a function of many variables. Our initial preference of grade is based on applying a more tough grade.

Series 3SJ6E, 3SJ6H		Material	Brinell Hardness	SFM	Feed per Insert	Grades				Coolant
						IN2005	IN2015	IN1530	IN2040	
Cast Iron	Gray	150-280	400-750	.003-.006			1		No	
	Nodular		300-650							
Steel	Low Carbon 1018, 8620	100-250	250-500	.003-.006	1			2	No	
	High Carbon F-6180	250-400	200-350							
	Alloyed Steel 4140, 4340	150-300	250-400	.003-.005						
	Tool Steel A-6, D-1, D-2	Up to 300								
Stainless Steel	300 Series, 304, 316	-	400-600	.003-.006	2	2	1	May not be required at high speeds		
	400 Series, 15-5 PH	Up to 320	300-600					Yes		
	13-8 PH	-	200-600							
Nickel Alloys	Inconel 600, 706, 718, 903, Hastelloy, Waspalloy	-	75-150	.003-.005	1	2	3	Yes		
Titanium	6AL-4V	-	100-200	.003-.005	2	2	1	Yes		

Series 3SJ6L		Material	Brinell Hardness	SFM	Feed per Insert	Grades					Coolant
						IN2005	IN2015	IN1530	IN2040	IN6515	
Cast Iron	Gray	150-280	400-750	.007-.018	3	1			2	No	
	Nodular		300-650								
Steel	Low Carbon 1018, 8620	100-250	250-500	.005-.015	1	3	2		No		
	High Carbon F-6180	250-400	200-350							.006-.013	
	Alloyed Steel 4140, 4340	150-300	250-400	.006-.015							
	Tool Steel A-6, D-1, D-2	Up to 300									
Stainless Steel	300 Series, 304, 316	-	250-400	.005-.010	2		1		May not be required at high speeds		
	400 Series, 15-5 PH	Up to 300	300-600						Yes		
	13-8 PH	-	200-250						.006-.012		
Nickel Alloys	Inconel 600, 706, 718, 903, Hastelloy, Waspalloy	-	75-150	.004-.007	1	2		Yes			
Titanium	6AL-4V	-	100-150	.004-.007	2	1		Yes			

The success of any cutter application is a function of many variables. Our initial preference of grade is based on applying a more tough grade.

SLOTTER OPERATING GUIDELINES

Series 15T, 12T		Material	Brinell Hardness	SFM	Feed per Insert		Grades					Coolant	
					SPLT06	SHLT09, APKT	IN2030	IN2005	IN1030	IN2040/IN1040	IN2015	12T1B, 15T	15T1D
Aluminum	6061 T-6, 7075 T-6	-	1000-8000	.003-.006	.004-.008						1	Yes	Yes
Cast Iron	Gray	150-250	350-1000	.002-.005	.003-.007		2				1	Optional	Yes
	Nodular												
Steel	Low Carbon 1018, 8620	100-250	450-800	.003-.008	.004-.009	1	2	1	3			Optional	Yes
	High Carbon F-6180, Nitralloy 52100	250-400	200-600	.003-.008	.004-.009								
	Alloyed Steel 4140, 4340, 6150	150-300	400-800	.003-.008	.004-.008	1	2	1	3				
	Tool Steel A-6, D-1, D-2, P-20	Up to 300	250-600	.002-.005	.003-.006								
Stainless Steel	300 Series, 304, 316	150-270	350-800	.003-.006	.004-.009							Yes	Yes
	400 Series 15-5 PH, 17-4 PH	Up to 320	275-600	.002-.005	.003-.006	1	2	1					
	13-8 PH		150-270										
Nickel Alloys	Inconel 600, 706, 718, 903, Hastelloy, Waspalloy	180-475	150-475	.002-.004	.003-.005	3	2	1				Yes	Yes
Titanium	6AL-4V	110-400	90-250	.002-.005	.003-.006	1	2	1				Yes	Yes

Series 5VK6V, 3VL5V		Material	Brinell Hardness	SFM	Feed per Insert	Grades							Coolant
						IN15K	IN2005	IN2015/IN2010	IN1530	IN2030	IN2040	IN6515/IN6510	
Aluminum	6061-T6, 7075-T6, 2024	-	1500-8000	.004-.015	1								Yes
Cast Iron	Gray	150-280	400-750	.005-.012			1				2		No
	Nodular		300-650	.004-.007							1		
			1500+										
Steel	Low Carbon 1018, 8620	100-250	250-500	.005-.010									No
	High Carbon F-6180, Nitralloy 52100	250-400	200-350	.005-.008		3		2	1				
	Alloyed Steel 4140, 4340, 6150	150-300	250-400	.005-.010									
	Tool Steel A-6, D-1, D-2, P-20	Up to 300											
Stainless Steel	300 Series, 304, 316	-	250-400	.003-.006									May not be required at high speeds Yes
	400 Series, 15-5 PH, 17-4 PH	Up to 320	300-600	.003-.006	3		1	2					
	13-8 PH	-	200-250	.004-.008									
Nickel Alloys	Inconel 600, 706, 718, 903, Hastelloy, Waspalloy	-	75-120	.003-.006		2	1	3				Yes	
Titanium	6AL-4V	-	100-150	.003-.006		2	2	1				Yes	

*Preferred for higher SFM.

The success of any cutter application is a function of many variables. Our initial preference of grade is based on applying a more tough grade.

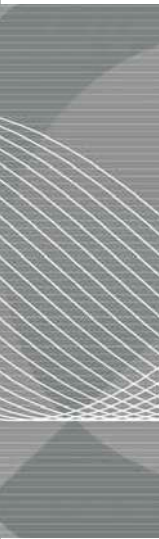

Ingersoll



SOLID CARBIDE MILLING CUTTERS.

Cutting Tools



Member IMC Group
Ingersoll
Cutting Tools

SOLID CARBIDE MILLING CUTTERS.

	Diameter	Cutting Depth	Description	Series	Page
	.312 - 1.000	.20 - .88	CHIP SURFER 0° Lead, 45° Helix, Center Cutting for Roughing & Finishing	47C, 47D Rough-fin Solid Carbide End Mill Tip	392
	.312 - .750	.20 - .62	CHIP SURFER 0° Lead, 45° Helix, Center Cutting	47C, 48C Solid Carbide Serrated Roughing Tip	393
	.312 - .500	.20 - .37	CHIP SURFER 0° Lead, 45° Helix, High Precision	46J, 46D Solid Carbide Center Cutting End Mill Tip	394
	.312 - 1.000	.20 - .88	CHIP SURFER 0° Lead, 38° Helix, Center Cutting	47J, 47D, 47C Solid Carbide End Mill Tip, Variable Pitch	395
	.312 - .750	.20 - .62	CHIP SURFER 0° Lead, 45° Helix, High Precision	47J, 47D Solid Carbide Center Cutting End Mill Tip	396
	.250	.20	CHIP SURFER 0° Lead, 45° Helix, Center Cutting	47J End Mill Tip	397
	.312 - 1.000	.20 - .88	CHIP SURFER 0° Lead, 45° Helix, Not Center Cutting	48D, 48J, 49D, 49J Solid Carbide Finishing End Mill Tip	398
	.312 - .750	.20 - .50	CHIP SURFER 0° Lead, 45° Helix, Center Cutting, Polished, Sharp	45D, 45J, 46D, 46J End Mill Tip for Aluminum	399
	.375 - .625	.38 - .60	CHIP SURFER 0° Lead, Center Cutting	45D Drill Mill Tip	400
	.375 - .625	.38 - .60	CHIP SURFER 3° Back Draft, Center Cutting	45V Flat Bottom Plunge Tip	401

	Diameter	Cutting Depth	Description	Series	Page
	.375 - .750	.02 - .06	CHIP SURFER High Feed Roughing, Center Cutting	45A Solid Carbide Ultra High Feed Tip	402
	.314 - 1.000	.016 - .145	CHIP SURFER High Feed Roughing, Center Cutting	47A, 48A 4 & 6 Flute High Feed Tip	403
	.375 - .625	.19 - .35	CHIP SURFER Back Draft Finishing, Not Center Cutting	48U Solid Carbide Backdraft Toroidal	404
	.312 - .625	.31 - .63	CHIP SURFER Straight Ball Nose	45B Ball Nose Tip	405
	.312 - .625	.31 - .63	CHIP SURFER High Precision Tip for Hardened Steel	45B Ball Nose Tip	405
	.375 - .750	.33 - .66	CHIP SURFER Straight Ball Nose	45X Straight Ball Nose Tip	406
	.312 - .750	.20 - .62	CHIP SURFER Helical Ball Nose	45B, 47B High Precision Ball Nose Tip	407
	.250	.20	CHIP SURFER Helical Ball Nose	47B High Precision Ball Nose Tip	408
	.312 - .750	.20 - .50	CHIP SURFER Helical Ball Nose	45B Helical Ball Nose Tip for Aluminum	409
	.315 - .390	.14 - .29	CHIP SURFER 30°, 45°, 60°, 72° Center Cutting	45N, 45M, 45P Chamfer and Spotting Tip	410

SOLID CARBIDE MILLING CUTTERS.

	Diameter	Cutting Depth	Description	Series	Page
	.500 - .787	.20 - .29	CHIP SURFER 45° Helix, Not Center Cutting	47N, 48N Solid Carbide Chamfer and Countersink	411
	.394 - .630	.425 - .560	CHIP SURFER Corner .062", .094", .156", .187" O.D. Radius	45R Solid Carbide Corner Rounding Tip	412
	.625	.13	CHIP SURFER Chamfer .062" x 45°	18T Front/Back Chamfer, V-Form Tip	413
	.500 - 1.000	.09 - .19	CHIP SURFER Corner .015"R, Chamfer .006" x 45°	18T Precision T-Slot Milling Tip	414
	.394 - .630	.252 - .445	CHIP SURFER Solid Carbide Thread Milling Tip	47Y	416
	.129 - .254	.181 - .350	CHIP SURFER 120° Included Point Angle, 10° - 15° Helical Flute, Center Drill	45Z	417
	.375 - .750	.22	CHIP SURFER 90° Lead End Mill	12J1D	418
	.750 - 1.000	.31	EVO TEC MINI 0° Lead End Mill	1SJ1Y (Chip Surfer Style)	420
	.500 - .750	.250 - .375	CHIP SURFER Pro-ball Tip	1BW7	421
	.312 - 1.250	-	CHIP SURFER Necked Down Straight Shanks	SO_SA, WB_SA	422

	Diameter	Cutting Depth	Description	Series	Page
	.625 - 1.25	-	CHIP SURFER Conical Shanks	SO_SK, WB_SK	423
	.312 - .750	-	CHIP SURFER Straight Shank, No Neck	SO_CA, SO_SA, SO_HA	430
	.25 - 1.00	-	CHIP SURFER Integral ER-Adaptor	ER_SA	425
	.300 - .940	-	CHIP SURFER Extension	T_SA	426
	.315 - 1.001	-	CHIP SURFER Blanks	4RJ	430
	.315 - .630	-	CHIP SURFER Ball Nose Blanks	4RB	430
	.075 - .405	-	CHIP SURFER T-Slot Preform Blanks	18T_RS000	429
	.250 - 1.000	.50 - 2.00	POWER ROUNDS Roughing End Mills, 3-flute, 38° Helix, w/Chipsplitters	46C_RM	432
	.125 - 1.000	1.50 - 4.50	POWER ROUNDS Precision End Mills, Medium and Long Length, 45° Helix	47J_RD, 48J_RD	433
	.250 - 1.000	.50 - 1.50	POWER ROUNDS Precision End Mills for Aluminum, 45° Helix	45J_RD, 46J_RD	434

SOLID CARBIDE MILLING CUTTERS.

	Diameter	Cutting Depth	Description	Series	Page
	.125 - .750	.50 - 1.25	POWER•ROUNDS Precision Center-Cutting End Mills, 2-Flute, 30° Helix	45C_RB	435
	.125 - .750	.38 - 1.50	POWER•ROUNDS Precision Center-cutting End Mills, 4 Flute, 38° Helix	47J_RC, 47D_RC	436
	.125 - 1.000	.25 - 1.50	POWER•ROUNDS Precision Center-cutting End Mills, 3 Flute, 38° Helix	46J_RC, 46D_RC	438
	.125 - 1.000	.25 - 2.00	STEDI•ROUNDS Solid Carbide End Mills for Roughing & Finishing, Variable Pitch	47C_RQ	439
	.250 - 1.000	.35 - 1.50	STEDI•ROUNDS Solid Carbide End Mills for Aluminum, 3-Flute, Variable Helix	46D_RQ	440
	.250 - 1.000	.50 - 1.50	ROUGHAN•ROUNDS Solid Carbide End Mills, Combination Roughing/Finishing	47C_RU	442
	.250 - .750	.50 - 1.87	ENI•ROUNDS 4 & 5 Flute Hi Feed Roughing End Mill w/ Variable Pitch & Chip Splitters	45D_RP	443
	.062 - .500	.03 - .25	PRO•ROUNDS Bull Nose Solid Carbide End Mills, 2 Flutes	45U	444
	.250 - .500	.12 - .18	FEED•ROUNDS Hi Feed Solid Carbide End Mills, 4 Flutes	45A_RA	445
	.125 - .750	.19 - 1.50	PRO•ROUNDS Ball Nose Solid Carbide End Mills, Multi-purpose	45B_RB, 46B_RB, 47B_RB	446

CHIP SURFER™ ROUGH-FIN SOLID CARBIDE END MILL TIP - 47C, 47D

0° LEAD, 45° HELIX, CENTER CUTTING FOR ROUGHING & FINISHING

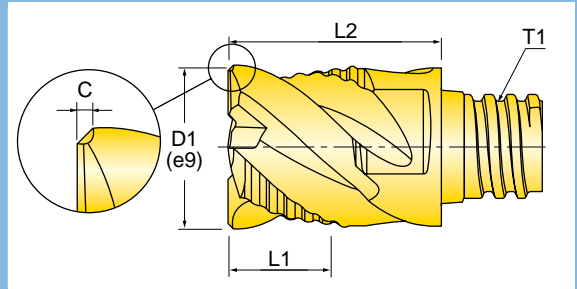
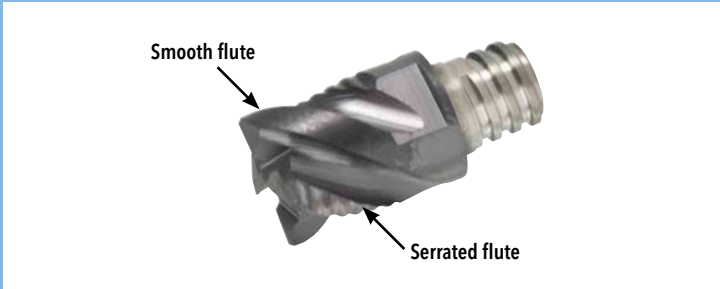
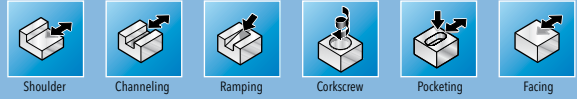

GRADES	P	M	K	N _(K)	S _(M)	H _(PK)
IN2005	+	+	+		+	

+ Good ○ Bad



Cutter Number	# Effective	D1 Nominal Diameter	L1 Cutting Edge Length	T1 Thread Size	L2 Extension Length	C Corner
47C-3120TQRU01	4	.312	.20	T05	.390	.012 x 45
47C-3727T6RU01	4	.375	.27	T06	.510	.012 x 45
47D-3727T6RU03	4	.375	.27	T06	.495	R .031
47C-5037T8RU01	4	.500	.37	T08	.650	.015 x 45
47D-5037T8RU03	4	.500	.37	T08	.645	R .031
47C-6247TRRU02	4	.625	.47	T10	.800	.024 x 45
47D-6247TRRU06	4	.625	.47	T10	.795	R .062
47C-7562TSRU02	4	.750	.62	T12	1.000	.024 x 45
47D-7562TSRU06	4	.750	.62	T12	.995	R .062
47C-1088TURU02	4	1.000	.88	T15	1.45	.024 x 45

Operating guidelines on [page 402](#).

Thread Size	HARDWARE	
	Wrench	Optional Torque Wrench
T05	WS-0043	DT-60-06
T06	WS-0029	DT-90-08
T08	WS-0030	DT-130-10
T10	WS-0044	DT-250-13
T12	WS-0059	DT-250-16
T15	WS-0061	-

When assembling, be sure carbide tip is seated firmly on shank with no gap.
 Note: DO NOT apply lubricant to the thread connection. Wrench not included with carbide tip or shank purchase.

CHIP SURFER™ SOLID CARBIDE SERRATED ROUGHING TIP - 47C, 48C

0° LEAD, 45° HELIX, 4 FLUTE CENTER CUTTING, 5 & 6 FLUTE NON-CENTER CUTTING

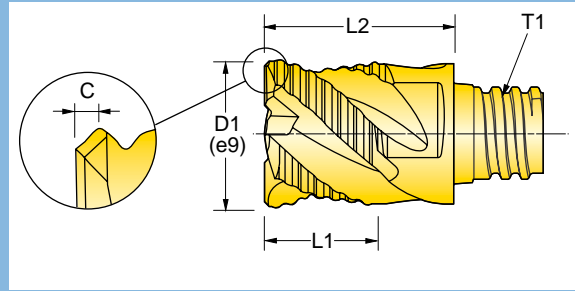
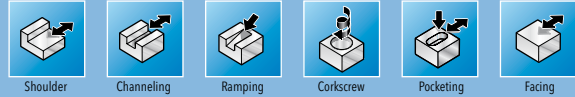

GRADES	P	M	K	N _(K)	S _(M)	H _(PK)
IN2005	+	+	+		+	

+ Good ○ Bad



Cutter Number	# Effective	D1 Nominal Diameter	L1 Cutting Edge Length	T1 Thread Size	L2 Extension Length	C Corner	Ramp Angle
47C-3120TQRN01	4	.312	.20	T05	.390	.010 x 45	90
47C-3727T6RN01	4	.375	.27	T06	.500	.013 x 45	90
47D-3727T6RN03	4	.375	.27	T06	.500	R .031	90
47C-5037T8RN01	4	.500	.37	T08	.650	.012 x 45	90
47D-5037T8RN03	4	.500	.37	T08	.645	R .031	90
47D-5037T8RN06	4	.500	.37	T08	.645	R .062	90
47C-6247TRRN01	5	.625	.47	T10	.800	.014 x 45	7
48C-7562TSRN01	6	.750	.62	T12	1.000	.016 x 45	3
48D-7562TSRN06	6	.750	.62	T12	.995	R .062	3

Operating guidelines on [page 402](#).

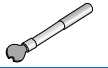
HARDWARE		
Thread Size	Wrench	Optional Torque Wrench
T05	WS-0043	DT-60-06
T06	WS-0029	DT-90-08
T08	WS-0030	DT-130-10
T10	WS-0044	DT-250-13
T12	WS-0059	DT-250-16

When assembling, be sure carbide tip is seated firmly on shank with no gap.

Note: DO NOT apply lubricant to the thread connection. Wrench not included with carbide tip or shank purchase.

CHIP SURFER™ SOLID CARBIDE END MILL TIP - 46J, 46D

0° LEAD, 45° HELIX, HIGH PRECISION, CENTER CUTTING

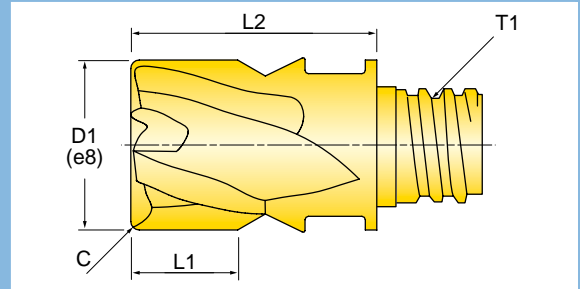
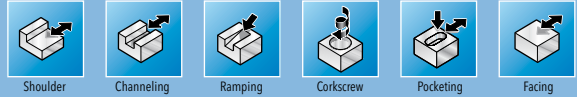

GRADES	P	M	K	N _(K)	S _(M)	H _(PK)
IN2005	+	+	+		+	○

+ Good ○ Bad



Cutter Number	# Effective	D1 Nominal Diameter	L1 Cutting Edge Length	T1 Thread Size	L2 Extension Length	C Corner
3-Flute End Mill Heads						
46J-3120TQRD04	3	.312	.20	T05	.39	SHARP
46D-3120TQRD03	3	.312	.20	T05	.39	R .031
46J-3727T6RD05	3	.375	.27	T06	.50	SHARP
46D-3727T6RD01	3	.375	.27	T06	.50	R .015
46D-3727T6RD03	3	.375	.27	T06	.50	R .031
46D-3727T6RD06	3	.375	.27	T06	.50	R .062
46J-5037T8RD06	3	.500	.37	T08	.65	SHARP
46D-5037T8RD01	3	.500	.37	T08	.65	R .015
46D-5037T8RD03	3	.500	.37	T08	.65	R .031
46D-5037T8RD06	3	.500	.37	T08	.65	R .062

Operating guidelines on [page 402](#).

Thread Size	Hardware	
	Wrench	Optional Torque Wrench
T05	WS-0043	DT-60-06
T06	WS-0029	DT-90-08
T08	WS-0030	DT-130-10

When assembling, be sure carbide tip is seated firmly on shank with no gap.

Note: DO NOT apply lubricant to the thread connection. Wrench not included with carbide tip or shank purchase.

CHIP SURFER™ SOLID CARBIDE END MILL TIP- VARIABLE PITCH - 47J, 47D, 47C

0° LEAD, 38° HELIX, CENTER CUTTING

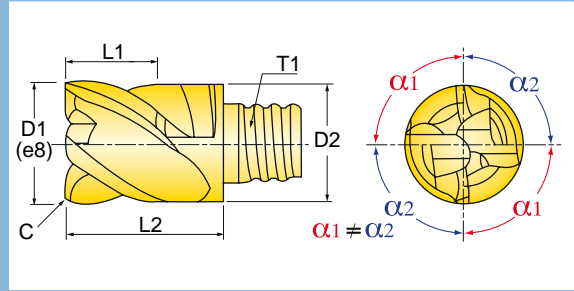
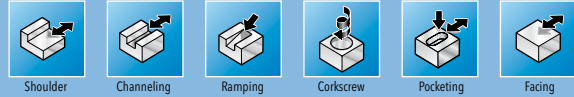

GRADES	P	M	K	N _(K)	S _(M)	H _(PK)
IN2005	+	+	+		+	○

+ Good ○ Bad



Cutter Number	# Effective	D1 Nominal Diameter	L1 Length of Cut	T1 Thread Size	L2 Extention Length	D2 Neck Diameter	C Corner
47J-3120TQRQ04	4	.312	.200	T5	.390	.300	SC
47D-3120TQRQ01	4	.312	.200	T5	.390	.300	R.015
47C-3120TQRQ01	4	.312	.200	T5	.390	.300	.012 x 45
47J-3727T6RQ05	4	.375	.270	T6	.510	.364	SC
47D-3727T6RQ01	4	.375	.270	T6	.510	.364	R.015
47C-3727T6RQ01	4	.375	.270	T6	.510	.364	.016 x 45
47J-5037T8RQ06	4	.500	.370	T8	.650	.480	SC
47D-5037T8RQ03	4	.500	.370	T8	.650	.480	R.031
47C-5037T8RQ02	4	.500	.370	T8	.650	.480	.020 x 45
47D-6247TRRQ03	4	.625	.470	T10	.810	.600	R.031
47C-6247TRRQ02	4	.625	.470	T10	.810	.600	.024 x 45
47D-7562TSRQ03	4	.750	.620	T12	1.000	.720	R.031
47D-7562TSRQ12	4	.750	.620	T12	1.000	.720	R.125
47C-7562TSRQ02	4	.750	.620	T12	1.000	.720	.024 x 45
47C-1088TURQ02	4	1.000	.880	T15	1.450	.940	.024 x 45
47D-1088TURQ03	4	1.000	.880	T15	1.450	.940	R.031
47D-1088TURQ12	5	1.000	.880	T15	1.450	.940	R.125

Operating guidelines on [page 402](#).

Thread Size	HARDWARE	
	Wrench	Optional Torque Wrench
T05	WS-0043	DT-60-06
T06	WS-0029	DT-90-08
T08	WS-0030	DT-130-10
T10	WS-0044	DT-250-13
T12	WS-0059	DT-250-16
T15	WS-0061	-

When assembling, be sure carbide tip is seated firmly on shank with no gap.
Note: DO NOT apply lubricant to the thread connection. Wrench not included with carbide tip or shank purchase.

CHIP SURFER™ SOLID CARBIDE END MILL TIP - 47J, 47D

0° LEAD, 45° HELIX, HIGH PRECISION, CENTER CUTTING

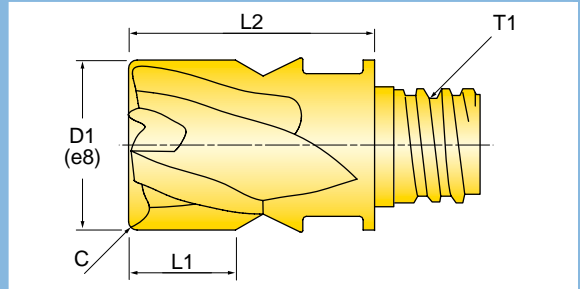
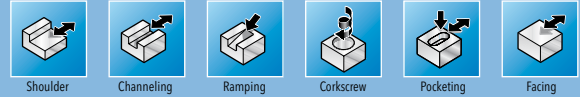

GRADES	P	M	K	N _(K)	S _(M)	H _(PK)
IN2005	+	+	+		+	○

+ Good ○ Bad



Cutter Number	# Effective	D1 Nominal Diameter	L1 Cutting Edge Length	T1 Thread Size	L2 Extension Length	C Corner
4-Flute End Mill Heads						
47J-3120QRD04	4	.312	.20	T05	.39	SHARP
47D-3120QRD01	4	.312	.20	T05	.39	R .015
47D-3120QRD03	4	.312	.20	T05	.39	R .031
47D-3120QRD06	4	.312	.20	T05	.39	R .062
47J-3727T6RD05	4	.375	.27	T06	.50	SHARP
47D-3727T6RD01	4	.375	.27	T06	.50	R .015
47D-3727T6RD03	4	.375	.27	T06	.50	R .031
47D-3727T6RD06	4	.375	.27	T06	.50	R .062
47J-5037T8RD06	4	.500	.37	T08	.65	SHARP
47D-5037T8RD01	4	.500	.37	T08	.65	R .015
47D-5037T8RD03	4	.500	.37	T08	.65	R .031
47D-5037T8RD06	4	.500	.37	T08	.65	R .062
47J-6247TRRD08	4	.625	.47	T10	.80	SHARP
47D-6247TRRD03	4	.625	.47	T10	.80	R .031
47D-6247TRRB06	4	.625	.47	T10	.80	R .062
47D-7562TSRD03	4	.750	.62	T12	1.00	R .031
47D-7562TSRB06	4	.750	.62	T12	1.00	R .062

Operating guidelines on [page 402](#).

CHIPSURFER PAKS

ORDER THIS PAK NUMBER	End Mill Tip	Straight Shank	D1 End Mill Diameter	R End Mill Corner	D2 Shank Adaption	L1 Length of Cut	L2 Projection Length	L3 Assm Length	Wrench
S037T06KA-06-11	47D-3727T6RD03	S037T06SA-06 (Steel)	.375	.031	.375 Cyl	.27	1.00	3.50	WS-0029
S050T08KA-06-11	47D-5037T8RD03	S050T08SA-06 (Steel)	.500	.031	.500 Cyl	.37	1.18	4.15	WS-0030

HARDWARE	Wrench	Optional Torque Wrench
Thread Size		
T05	WS-0043	DT-60-06
T06	WS-0029	DT-90-08
T08	WS-0030	DT-130-10
T10	WS-0044	DT-250-13
T12	WS-0059	DT-250-16





When assembling, be sure carbide tip is seated firmly on shank with no gap.

Note: DO NOT apply lubricant to the thread connection. Wrench not included with carbide tip or shank purchase.

CHIP SURFER™ END MILL TIP - 47J

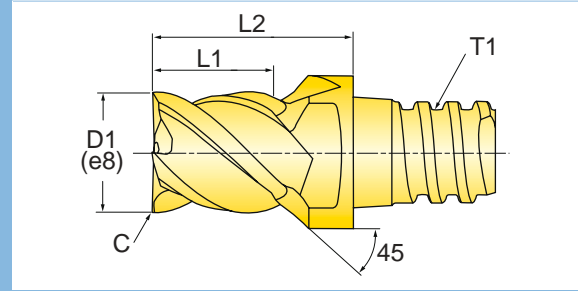
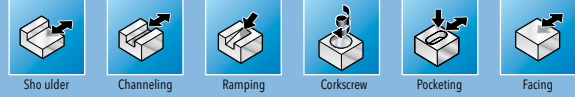
0° LEAD, 45° HELIX, CENTER CUTTING



GRADES	P	M	K	N _(K)	S _(M)	H _(PK)
IN2005	+	+	+		+	○

+ Good ○ Bad



Cutter Number	# Effective	D1 Nominal Diameter	L1 Length of Cut	T1 Thread Size	L2 Extension Length	C Corner
47J-2520TQRD04	4	0.250	0.20	T5	0.39	Sharp

Operating guidelines on [page 402](#).

HARDWARE		
Thread Size	Wrench	Optional Torque Wrench
T05	WS-0043	DT-60-06

When assembling, be sure carbide tip is seated firmly on shank with no gap.
 Note: DO NOT apply lubricant to the thread connection. Wrench not included with carbide tip or shank purchase.

0° LEAD, 45° HELIX, NOT CENTER CUTTING

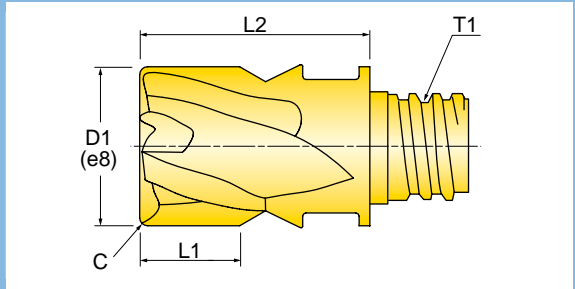
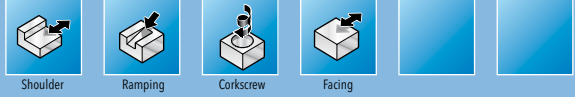

GRADES	P	M	K	N _(K)	S _(M)	H _(PK)
IN2005	+	+	+		+	+

+ Good ○ Bad



Cutter Number	# Effective	D1 Nominal Diameter	L1 Cutting Edge Length	T1 Thread Size	L2 Extension Length	C Corner	Ramp Angle
48J-3120TQRD04	6	.312	.20	T05	.39	SHARP	3
48D-3120TQRD03	6	.312	.20	T05	.39	R .031	3
48J-3727T6RD05	6	.375	.27	T06	.50	SHARP	5
48D-3727T6RD01	6	.375	.27	T06	.50	R .015	5
48D-3727T6RD03	6	.375	.27	T06	.50	R .031	5
48D-3727T6RD06	6	.375	.27	T06	.50	R .062	5
48J-5037T8RD06	6	.500	.37	T08	.65	SHARP	5
48D-5037T8RD01	6	.500	.37	T08	.65	R .015	5
48D-5037T8RD03	6	.500	.37	T08	.65	R .031	5
48D-5037T8RD06	6	.500	.37	T08	.65	R .062	5
49J-6247TRRD08	8	.625	.47	T10	.80	SHARP	5
49D-6247TRRD03	8	.625	.47	T10	.80	R .031	5
49D-6247TRRD06	8	.625	.47	T10	.80	R .062	5
49D-7562TSRD03	10	.750	.62	T12	1.00	R .031	3
49D-7562TSRD06	10	.750	.62	T12	1.00	R .062	3
49D-7562TSRD12	8	.750	.62	T12	1.00	R .125	-
49D-1088TURD12	10	1.000	.88	T15	1.45	R .125	-

Operating guidelines on [page 402](#).

Thread Size	HARDWARE	
	Wrench	Optional Torque Wrench
T05	WS-0043	DT-60-06
T06	WS-0029	DT-90-08
T08	WS-0030	DT-130-10
T10	WS-0044	DT-250-13
T12	WS-0059	DT-250-16
T15	WS-0061	-

When assembling, be sure carbide tip is seated firmly on shank with no gap.
 Note: DO NOT apply lubricant to the thread connection. Wrench not included with carbide tip or shank purchase.

CHIP SURFER™ END MILL TIP FOR ALUMINUM - 45D, 45J, 46D, 46J

0° LEAD, 45° HELIX, CENTER CUTTING, POLISHED, SHARP

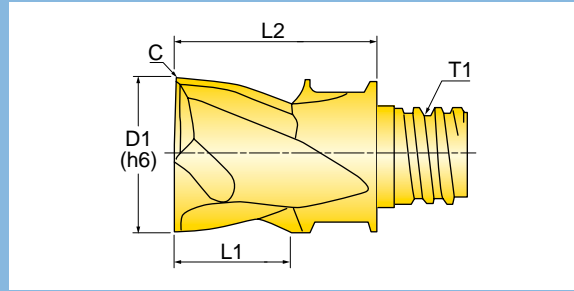
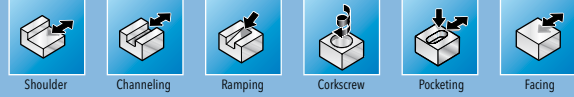

GRADES	P	M	K	N _(K)	S _(M)	H _(PK)
IN05S				+		

+ Good ○ Bad



Cutter Number	# Effective	D1 Nominal Diameter	L1 Cutting Edge Length	T1 Thread Size	L2 Extension Length	C Corner
46D-3120TQRD02-P	3	.312	.20	T05	.39	R .020
45J-3727T6RD05-P	2	.375	.27	T06	.50	SHARP
45D-3727T6RD02-P	2	.375	.27	T06	.50	R .020
46D-3727T6RD03-P	3	.375	.27	T06	.50	R .031
46D-3727T6RD06-P	3	.375	.27	T06	.50	R .062
45J-5037T8RD06-P	2	.500	.37	T08	.65	SHARP
46D-5037T8RD02-P	2	.500	.37	T08	.65	R .020
46D-5037T8RD03-P	3	.500	.37	T08	.65	R .031
46D-5037T8RD06-P	3	.500	.37	T08	.65	R .062
46D-5037T8RD09-P	3	.500	.37	T08	.65	R .094
46D-5037T8RD12-P	3	.500	.37	T08	.65	R .125
46J-6239TRRD08-P	3	.625	.39	T10	.80	SHARP
46D-6239TRRD03-P	3	.625	.39	T10	.80	R .031
46D-6239TRRD06-P	3	.625	.39	T10	.80	R .062
46D-6239TRRD09-P	3	.625	.39	T10	.80	R .094
46D-6239TRRD12-P	3	.625	.39	T10	.80	R .125
46D-7550TSRD02-P	3	.750	.50	T12	1.00	R .020
46D-7550TSRD06-P	3	.750	.50	T12	1.00	R .062
46D-7550TSRD09-P	3	.750	.50	T12	1.00	R .094
46D-7550TSRD12-P	3	.750	.50	T12	1.00	R .125

Operating guidelines on [page 402](#).

Thread Size	HARDWARE	
	Wrench	Optional Torque Wrench
T05	WS-0043	DT-60-06
T06	WS-0029	DT-90-08
T08	WS-0030	DT-130-10
T10	WS-0044	DT-250-13
T12	WS-0059	DT-250-16

When assembling, be sure carbide tip is seated firmly on shank with no gap.

Note: DO NOT apply lubricant to the thread connection. Wrench not included with carbide tip or shank purchase.

0° LEAD, CENTER CUTTING

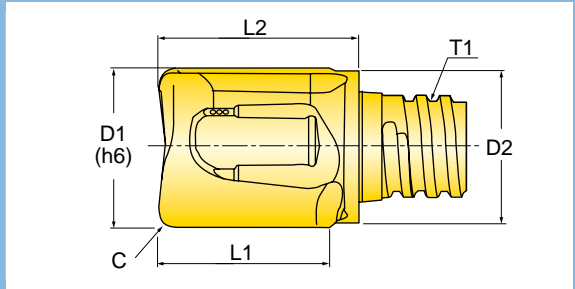
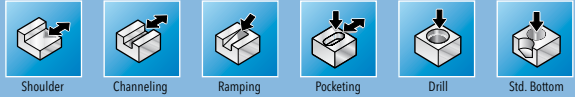

GRADES	P	M	K	N _(K)	S _(M)	H _(PK)
IN2005	+	+	+		+	○

+ Good ○ Bad



Cutter Number	# Effective	D1 Nominal Diameter	D2 Flange Diameter	T1 Thread Size	L1* Edge Length	L2 Extension Length	C Corner
45D-3738T6RA01	2	.375	.35	T06	.38	.48	R .015
45D-5045T8RA01	2	.500	.48	T08	.45	.60	R .015
45D-6263TRRA01	2	.625	.60	T10	.60	.75	R .015

*Drill depth not to exceed 2/3 edge length.
Operating guidelines on [page 402](#).

CHIPSURFER PAKS

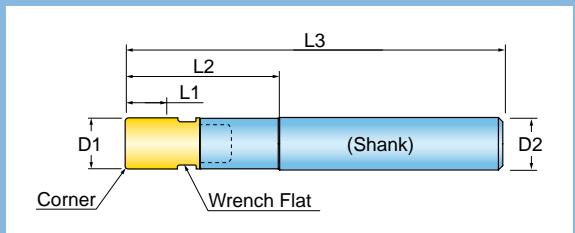

ORDER THIS PAK NUMBER	(QTY) End Mill Tip	Straight Shank	D1 End Mill Dia.	End Mill Corner	D2 Shank Adaption	L1 Length of Cut	L2 Projection Length	L3 Assem. Length	Wrench
S037T06KA-06-D1	(2) 45D-3738T6RA01	S037T06SA-06 (Steel)	.375	.015	.375 Cylindrical	.38	.98	3.48	WS-0029
S050T08KA-06-D1	(2) 45D-5045T8RA01	S050T08SA-06 (Steel)	.500	.015	.500 Cylindrical	.45	1.13	4.10	WS-0030

HARDWARE		
Thread Size	Wrench	Optional Torque Wrench
T06	WS-0029	DT-90-08
T08	WS-0030	DT-130-10
T10	WS-0044	DT-250-13

When assembling, be sure carbide tip is seated firmly on shank with no gap.
Note: DO NOT apply lubricant to the thread connection. Wrench not included with carbide tip or shank purchase.

CHIP SURFER™ FLAT BOTTOM PLUNGE TIP - 45V

3° BACK DRAFT, CENTER CUTTING

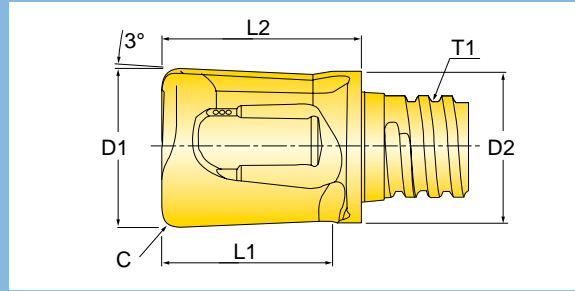

GRADES	P	M	K	N _(K)	S _(M)	H _(PK)
IN2005	+	+	+		+	○

+ Good ○ Bad



Cutter Number	# Effective	D1 Nominal Diameter	D2 Flange Diameter	T1 Thread Size	* L1 Edge Length	L2 Extension Length	C Corner
45V-3738T6RA03	2	.375	.35	T06	.38	.48	R .031
45V-5045T8RA03	2	.500	.48	T08	.45	.60	R .031
45V-6260TRRA03	2	.625	.60	T10	.60	.75	R .031

*If used for spot facing, drilling or boring, drill depth not to exceed 2/3 edge length.
Operating guidelines on [page 402](#).

CHIPSURFER PAKS

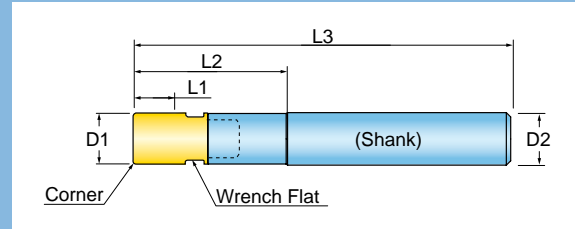

ORDER THIS PAK NUMBER	(QTY) End Mill Tip	Straight Shank	D1 End Mill Dia.	End Mill Corner	D2 Shank Adaption	L1 Length of Cut	L2 Projection Length	L3 Assem. Length	Wrench
S037T06KA-06-P1	(2) 45V-3738T6RA03	S037T06SA-06 (Steel)	.375	.030	.375 Cylindrical	.38	.98	3.48	WS-0029
S050T08KA-06-P1	(2) 45V-5045T8RA03	S050T08SA-06 (Steel)	.500	.030	.500 Cylindrical	.45	1.13	4.10	WS-0030

HARDWARE	Wrench	Optional Torque Wrench
Thread Size		
T06	WS-0029	DT-90-08
T08	WS-0030	DT-130-10
T10	WS-0044	DT-250-13

When assembling, be sure carbide tip is seated firmly on shank with no gap.
Note: DO NOT apply lubricant to the thread connection. Wrench not included with carbide tip or shank purchase.

HIGH FEED ROUGHING, CENTER CUTTING

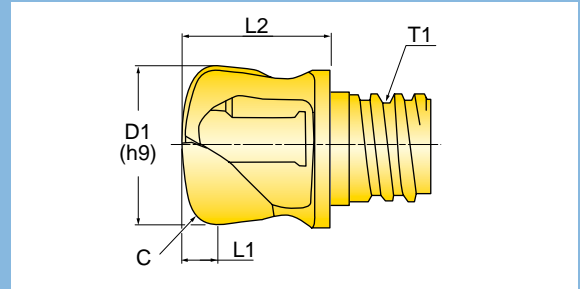
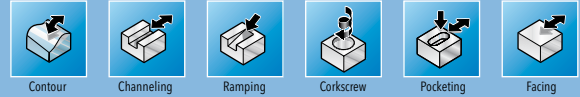

GRADES	P	M	K	N _(K)	S _(M)	H _(PK)
IN2005	+	+	+		+	+

+ Good ○ Bad



Cutter Number	# Effective	D1 Nominal Diameter	L1 Depth of Cut	T1 Thread Size	L2 Extension Length	C Corner
45A-3703T6RA06	2	.375	.02	T06	.47	0.080
45A10001T6RA20	2	.394 (10mm)	.02	T06	.49	0.080
45A12001T8RA25	2	.472 (12mm)	.04	T08	.44	0.100
45A-5004T8RA08	2	.500	.04	T08	.59	0.100
45A16001TRRA30	2	.629 (16mm)	.04	T10	.80	0.120
45A-7506TSRA12	2	.750	.06	T12	.70	0.120

Operating guidelines on [page 406](#).

CHIPSURFER PAKS



NOTE: Program as for a square bottom end mill with noted corner radius. This method will ensure and minimize remaining stock for secondary passes.

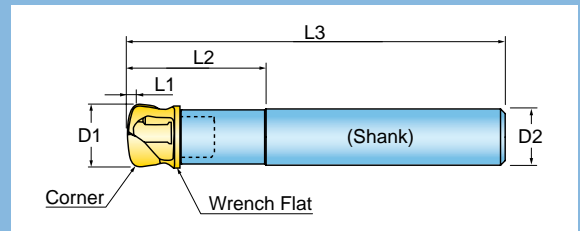
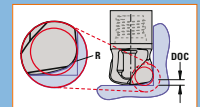

ORDER THIS PAK NUMBER	(QTY) End Mill Tip	Straight Shank	D1 End Mill Dia.	D2 Shank Adaption	L1 Depth of Cut	L2 Projection Length	L3 Assem. Length	Wrench
S037T06KA-06-F2	(2) 45A-3703T6RA06	S037T06SA-06 (stl)	.375	.375 Cyl	.02	.98	3.48	WS-0029
S037T06KA-20-F2	(2) 45A-3703T6RA06	S037T06CA-20 (carb)	.375	.375 Cyl	.02	2.43	5.23	WS-0029
S050T08KA-06-F1	(2) 45A12001T8RA25	S050T08SA-061(stl)	.472 (12mm)	.500 Cyl	.04	1.07	3.94	WS-0030
S050T08KA-25-F1	(2) 45A12001T8RA25	S050T08CA-251(carb)	.472 (12mm)	.500 Cyl	.04	2.90	5.94	WS-0030
S050T08KA-06-F2	(2) 45A-5004T8RA08	S050T08SA-06 (stl)	.500	.500 Cyl	.04	1.33	4.30	WS-0030
S050T08KA-25-F2	(2) 45A-5004T8RA08	S050T08CA-25 (carb)	.500	.500 Cyl	.04	3.25	6.30	WS-0030

HARDWARE	Wrench	Optional Torque Wrench
Thread Size		
T06	WS-0029	DT-90-08
T08	WS-0030	DT-130-10
T10	WS-0044	DT-250-13
T12	WS-0059	DT-250-16

When assembling, be sure carbide tip is seated firmly on shank with no gap.
 Note: DO NOT apply lubricant to the thread connection. Wrench not included with carbide tip or shank purchase.

CHIP SURFER™ 4 & 6 FLUTE HIGH FEED TIP - 47A, 48A

HIGH FEED ROUGHING, CENTER CUTTING

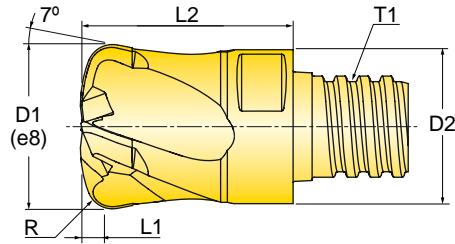
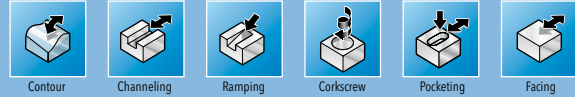

GRADES	P	M	K	N _(K)	S _(M)	H _(PK)
IN2006	+	+	+		+	+

+ Good ○ Bad



Cutter Number	# Effective	D1 Nominal Diameter	D2 Flange Diameter	R Radius	T1 Thread Size	L1 Depth of Cut	L2 Extension Length
47A08001TQRA16	4	.314 (8 mm)	0.295	0.065	T05	0.016	0.393
47A10001T6RA20	4	.393 (10 mm)	0.374	0.080	T06	0.019	0.511
47A-5004T8RA09	4	0.500	0.480	0.100	T08	0.023	0.649
47A16001TRRA32	4	.630 (16 mm)	0.608	0.125	T10	0.031	0.807
47A20001TSRA40	4	.787 (20 mm)	0.726	0.160	T12	0.039	1.000
48A-1004TURA20	6	1.000	0.940	0.145	T15	0.047	1.450

Operating guidelines on [page 404](#).

NOTE: Program as for a square bottom end mill with noted corner radius. This method will ensure and minimize remaining stock for secondary passes.

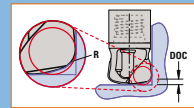

Thread Size	HARDWARE	
	Wrench	Optional Torque Wrench
T05	WS-0043	DT-60-06
T06	WS-0029	DT-90-08
T08	WS-0030	DT-130-10
T10	WS-0044	DT-250-13
T12	WS-0059	DT-250-16
T15	WS-0061	-

When assembling, be sure carbide tip is seated firmly on shank with no gap.

Note: DO NOT apply lubricant to the thread connection. Wrench not included with carbide tip or shank purchase.

BACK DRAFT FINISHING, NOT CENTER CUTTING

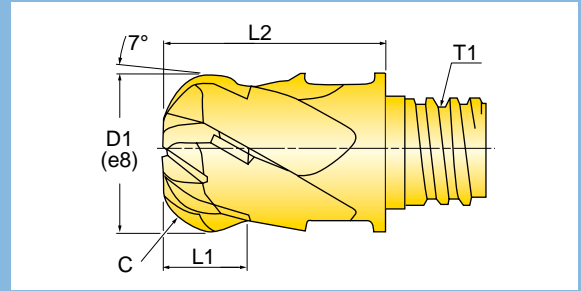

GRADES	P	M	K	N _(K)	S _(M)	H _(PK)
IN2005	+	+	+		+	○

+ Good ○ Bad



Cutter Number	# Effective	D1 Nominal Diameter	L1 Cutting Edge Length	T1 Thread Size	L2 Extension Length	C Corner	Ramp Angle
48U-3719T6RB03	6	.375	.19	T06	.50	R .031	9°
48U-3719T6RB06	6	.375	.19	T06	.50	R .062	9°
48U-5027T8RB03	6	.500	.27	T08	.65	R .031	9°
48U-5027T8RB06	6	.500	.27	T08	.65	R .062	9°
48U-5027T8RB12	6	.500	.27	T08	.65	R .125	9°
48U-6235TRRB20	6	.625	.35	T10	.80	R .200	9°

Operating guidelines on [page 402](#).

Thread Size	HARDWARE	
	Wrench	Optional Torque Wrench
T06	WS-0029	DT-90-08
T08	WS-0030	DT-130-10
T10	WS-0044	DT-250-13

When assembling, be sure carbide tip is seated firmly on shank with no gap.
 Note: DO NOT apply lubricant to the thread connection. Wrench not included with carbide tip or shank purchase.

CHIP SURFER™ BALL NOSE TIPS - 45B

STRAIGHT BALL NOSE

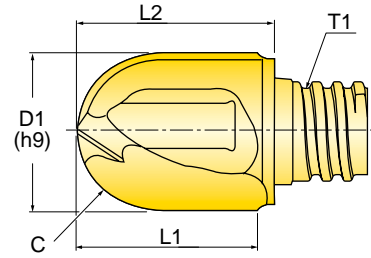
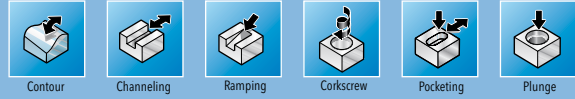

GRADES

IN2005

P	M	K	N _(K)	S _(M)	H _(PK)
+	+	+		+	+

+ Good ○ Bad



Cutter Number	# Effective	D1 Nominal Diameter	L1 Cutting Edge Length	T1 Thread Size	L2 Extension Length	C Corner
45B-3131TQRA04	2	.312	.31	T05	.39	R .156
45B-3738T6RA04	2	.375	.38	T06	.48	R .187
45B-5050T8RA06	2	.500	.50	T08	.64	R .250
45B-6263TRRA07	2	.625	.63	T10	.75	R .312

Operating guidelines on [page 402](#).

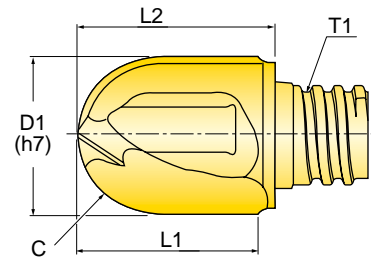

HIGH PRECISION TIP FOR HARDENED STEEL

GRADES

IN2006

P	M	K	N _(K)	S _(M)	H _(PK)
+		+			+

+ Good ○ Bad



Cutter Number	# Effective	D1 Nominal Diameter	L1 Cutting Edge Length	T1 Thread Size	L2 Extension Length	C Corner
45B-3131TQRW04	2	.312	.31	T05	.39	R .156
45B-3738T6RW04	2	.375	.38	T06	.48	R .187
45B-5050T8RW06	2	.500	.50	T08	.64	R .250
45B-6263TRRW07	2	.625	.63	T10	.75	R .312

Operating guidelines on [page 402](#).

HARDWARE



Thread Size

Wrench

Optional Torque Wrench

T05	WS-0043	DT-60-06
T06	WS-0029	DT-90-08
T08	WS-0030	DT-130-10
T10	WS-0044	DT-250-13

When assembling, be sure carbide tip is seated firmly on shank with no gap.

Note: DO NOT apply lubricant to the thread connection. Wrench not included with carbide tip or shank purchase.

CHIP SURFER™ SPHERICAL BALL NOSE TIP - 45X

STRAIGHT BALL NOSE

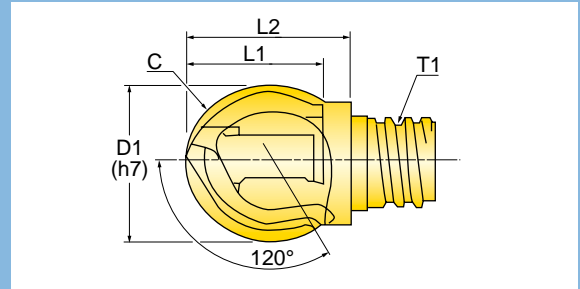
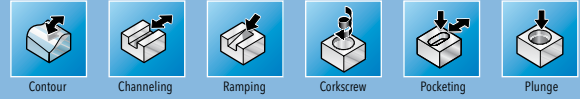

GRADES	P	M	K	N _(K)	S _(M)	H _(PK)
IN2005	+	+	+		+	+

+ Good ○ Bad



Cutter Number	# Effective	D1 Nominal Diameter	T1 Thread Size	L1 Cutting Length	L2 Extension Length	C Corner
45X-3727TQRA03	2	.375	T05	.33	.38	R .187
45X-5037T6RA04	2	.500	T06	.40	.48	R .250
45X-6248T8RA06	2	.625	T08	.55	.60	R .312
45X-7560TRRA07	2	.750	T10	.66	.71	R .375

Operating guidelines on [page 402](#).

Thread Size	HARDWARE	
	Wrench	Optional Torque Wrench
T05	WS-0043	DT-60-06
T06	WS-0029	DT-90-08
T08	WS-0030	DT-130-10
T10	WS-0044	DT-250-13

When assembling, be sure carbide tip is seated firmly on shank with no gap.

Note: DO NOT apply lubricant to the thread connection. Wrench not included with carbide tip or shank purchase.

CHIP SURFER™ HIGH PRECISION BALL NOSE TIP - 45B, 47B

HELICAL BALL NOSE

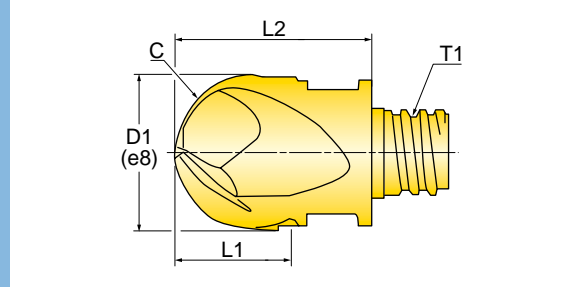
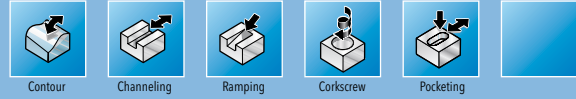

GRADES	P	M	K	N _(K)	S _(M)	H _(PK)
IN2005	+	+	+		+	○

+ Good ○ Bad



Cutter Number	# Effective	D1 Nominal Diameter	L1 Cutting Edge Length	T1 Thread Size	L2 Extension Length	C Corner	Tolerance
45B-3120QRB03	2	.312	.20	T05	.39	R.156	.0004
47B-3120QRB03	4	.312	.20	T05	.39	R.156	.0004
45B-3727T6RB05	2	.375	.27	T06	.51	R.187	.0004
47B-3727T6RB05	4	.375	.27	T06	.51	R.187	.0004
45B-5037T8RB06	2	.500	.37	T08	.65	R.250	.0005
47B-5037T8RB06	4	.500	.37	T08	.65	R.250	.0005
45B-6235TRRB08	2	.625	.35	T10	.80	R.312	.0005
47B-6247TRRB08	4	.625	.47	T10	.80	R.312	.0005
45B-7550TSRB10	2	.750	.50	T12	1.00	R.374	.0005
47B-7562TSRB10	4	.750	.62	T12	1.00	R.374	.0005

Operating guidelines on [page 402](#).

CHIPSURFER PAKS

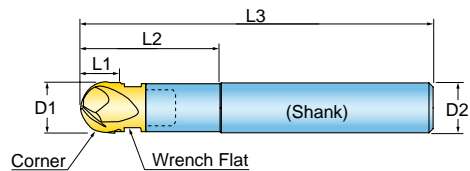

ORDER THIS Pak Number	(QTY) Ball Nose Tip	Straight Shank	D1 Ball Nose Dia.	Ball Nose Corner	D2 Shank Adaption	L1 Length of Cut	L2 Projection Length	L3 Assem. Length	Wrench
S037T06KA-06-05	(2) 47B-3727T6RB05	S037T06SA-06 (Steel)	.375	.187	.375 Cyl	.27	1.00	3.50	WS-0029
S037T06KA-20-05	(2) 47B-3727T6RB05	S037T06CA-20 (Carbide)	.375	.187	.375 Cyl	.27	2.45	5.25	WS-0029
S050T08KA-06-05	(2) 47B-5037T8RB06	S050T08SA-06 (Steel)	.500	.250	.500 Cyl	.37	1.18	4.15	WS-0030
S050T08KA-25-05	(2) 47B-5037T8RB06	S050T08CA-25 (Carbide)	.500	.250	.500 Cyl	.37	3.10	6.15	WS-0030

HARDWARE

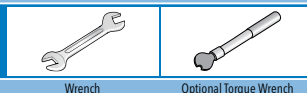

Thread Size	Wrench	Optional Torque Wrench
T05	WS-0043	DT-60-06
T06	WS-0029	DT-90-08
T08	WS-0030	DT-130-10
T10	WS-0044	DT-250-13
T12	WS-0059	DT-250-16

When assembling, be sure carbide tip is seated firmly on shank with no gap.

Note: DO NOT apply lubricant to the thread connection. Wrench not included with carbide tip or shank purchase.

HELICAL BALL NOSE

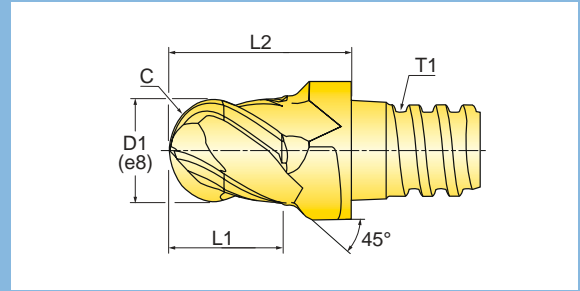
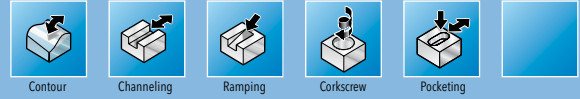

GRADES	P	M	K	N _(K)	S _(M)	H _(PK)
IN2005	+	+	+		+	○

+ Good ○ Bad



Cutter Number	# Effective	D1 Nominal Diameter	L1 Length of Cut	T1 Thread Size	L2 Extension Length	Corner	Tolerance
47B-2520TQRB03	4	0.250	0.20	T5	0.39	0.125	0.0004

Operating guidelines on [page 402](#).

Thread Size	HARDWARE	
	Wrench	Optional Torque Wrench
T05	WS-0043	DT-60-06
T06	WS-0029	DT-90-08
T08	WS-0030	DT-130-10
T10	WS-0044	DT-250-13
T12	WS-0059	DT-250-16

When assembling, be sure carbide tip is seated firmly on shank with no gap.
 Note: DO NOT apply lubricant to the thread connection. Wrench not included with carbide tip or shank purchase.

CHIP SURFER™ HIGH PRECISION BALL NOSE TIP FOR ALUMINUM - 45B

HELICAL BALL NOSE

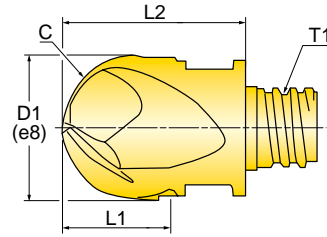
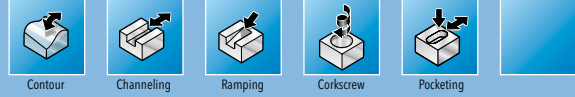

GRADES

IN05S

P	M	K	N _(K)	S _(M)	H _(PK)
			+		

+ Good ○ Bad



Cutter Number	# Effective	D1 Nominal Diameter	L1 Cutting Edge Length	T1 Thread Size	L2 Extension Length	C Corner	Tolerance
45B-3120QRB03-P	2	.312	.20	T05	.39	R.156	.0004
45B-3727T6RB05-P	2	.375	.27	T06	.51	R.187	.0004
45B-5037T8RB06-P	2	.500	.37	T08	.65	R.250	.0005
45B-6247TRRB08-P	2	.625	.47	T10	.80	R.312	.0005
45B-7550TSRB10-P	2	.750	.50	T12	1.00	R.375	.0005

Operating guidelines on [page 402](#).

HARDWARE



Thread Size

Wrench

Optional Torque Wrench

T05	WS-0043	DT-60-06
T06	WS-0029	DT-90-08
T08	WS-0030	DT-130-10
T10	WS-0044	DT-250-13
T12	WS-0059	DT-250-16

When assembling, be sure carbide tip is seated firmly on shank with no gap.

Note: DO NOT apply lubricant to the thread connection. Wrench not included with carbide tip or shank purchase.

CHIP SURFER™ CHAMFER AND SPOTTING TIP - 45N, 45M, 45P

30°, 45°, 60°, 72°, CENTER CUTTING



Spot Drilling



Chamfering

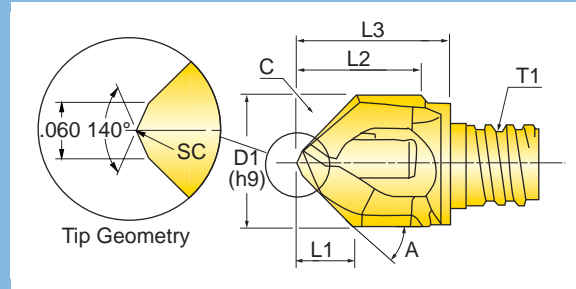

GRADES

IN2005

P	M	K	N _(K)	S _(M)	H _(PK)
+	+	+	○	+	○

+ Good ○ Bad



Cutter Number	A Nominal Chamfer Angle	# Effective	D1 Nominal Diameter	L1 Cutting Length	T1 Thread Size	L2 Depth	L3 Extension Length
45N08007TQRA45	45°	2	.315	.14	T05	.27	.38
45N10009T6RA45	45°	2	.390	.18	T06	.35	.50
45N10009T6RA72	72°	2	.390	.06	T06	.35	.50
45N16015TRRA45	45°	2	.625	.29	T10	.59	.75
45M10009T6RA30	30°	2	.390	.26	T06	.37	.50
45P10009T6RA60	60°	2	.390	.10	T06	.39	.50

Operating guidelines on [page 402](#).

CHIPSURFER PAKS

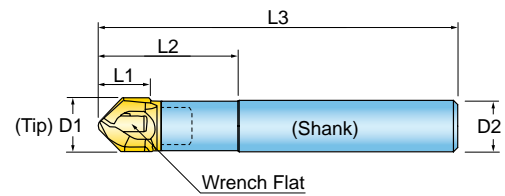

ORDER THIS PAK NUMBER	(QTY) Chamfer/Spotter Tip	Straight Shank	D ₁ End Mill Dia.	Included Angle	D ₂ Shank Adaption	L ₁ Length of Cut	L ₂ Projection Length	L ₃ Assem. Length	Wrench
S037T06KA-06-07	(2) 45N-10009T6RA45	S037T06SA-06 (Steel)	.400	90°	.375 Cylindrical	.46	.96	3.50	WS-0029

HARDWARE



Wrench



Optional Torque Wrench

Thread Size

T05	WS-0043	DT-60-06
T06	WS-0029	DT-90-08
T10	WS-0044	DT-250-13

When assembling, be sure carbide tip is seated firmly on shank with no gap.

Note: DO NOT apply lubricant to the thread connection. Wrench not included with carbide tip or shank purchase.

CHIP SURFER™ SOLID CARBIDE CHAMFER AND COUNTERSINK - 47N, 48N

45° HELIX, NOT CENTER CUTTING



Chamfering



Counter-Sink

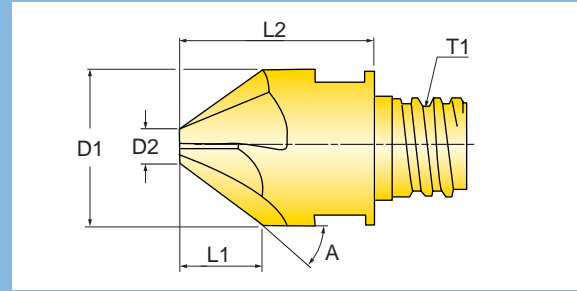

GRADES	P	M	K	N _(K)	S _(M)	H _(PK)
IN2005	+	+	+	○	+	○

+ Good ○ Bad



Cutter Number	A Nominal Chamfer Angle	# Effective	D1 Nominal Diameter	D2 Inner Diameter	T1 Thread Size	L1 Length of Cut	L2 Extension Length
47N-5006T8RA45	45°	4	.500	.078	T08	0.20	.65
48N20025TSRA45	45°	6	.787	.197	T12	0.29	1.00

Operating guidelines on [page 402](#).

HARDWARE		
Thread Size	Wrench	Optional Torque Wrench
T08	WS-0030	DT-130-10
T12	WS-0059	DT-250-16

When assembling, be sure carbide tip is seated firmly on shank with no gap.

Note: DO NOT apply lubricant to the thread connection. Wrench not included with carbide tip or shank purchase.

CORNER .062", .094", .125", .156" and .187" R (O.D. Radius)

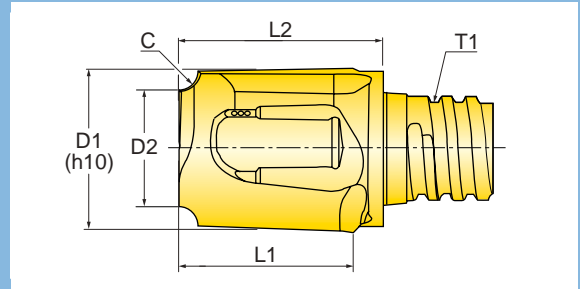

GRADES	P	M	K	N _(K)	S _(M)	H _(PK)
IN2005	+	+	+	○	+	○

+ Good ○ Bad



Cutter Number	# Effective	D1 Nominal Diameter	D2 Inner Diameter	L1 Length	T1 Thread Size	L2 Extension Length	C Corner
45R10009T6RA16	2	0.394 (10mm)	.268	.425	T06	.49	R .06 (1.6mm)
45R10009T6RA25	2	0.394 (10mm)	.200	.395	T06	.49	R .09 (2.5mm)
45R12012T8RA30	2	0.472 (12mm)	.256	.485	T08	.61	R .12 (3.0mm)
45R12012T8RA40	2	0.472 (12mm)	.185	.455	T08	.61	R .15 (4.0mm)
45R16015TRRA50	2	0.630 (16mm)	.244	.560	T10	.75	R .19 (5.0mm)

Operating guidelines on [page 402](#).

HARDWARE



Thread Size

Wrench

Optional Torque Wrench

T06	WS-0029	DT-90-08
T08	WS-0030	DT-130-10
T10	WS-0044	DT-250-13

When assembling, be sure carbide tip is seated firmly on shank with no gap.

Note: DO NOT apply lubricant to the thread connection. Wrench not included with carbide tip or shank purchase.

CHIP SURFER™ FRONT/BACK CHAMFER, V-FORM TIP - 18T

CHAMFER .062" x 45°

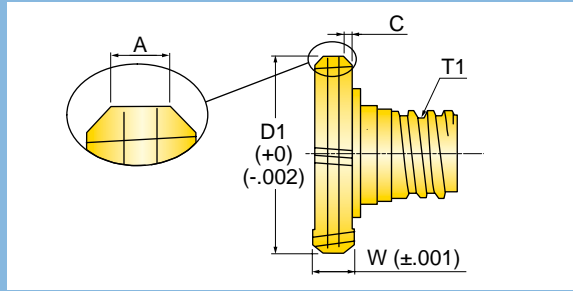
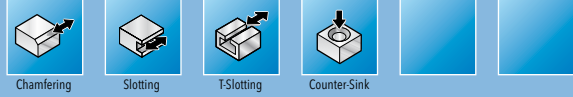

GRADES	P	M	K	N _(K)	S _(M)	H _(PK)
IN1030	+	+	+		+	○

+ Good ○ Bad



Cutter Number	# Effective	D1 Nominal Diameter	Max. Radial Depth of Cut	T1 Thread Size	A Width	W Width	C Corner	Driver Size/Torque Value (in lbs.)
18T-6216T6RN06	6	.625	.13	T06	.030	.156	.062 x 45°	1/60

Operating guidelines on [page 410](#).

HARDWARE		
Driver Size	Torx Driver	Optional Torque Bit
1	DS-T20T	DS-T20B

When assembling, be sure carbide tip is seated firmly on shank with no gap.
 Note: DO NOT apply lubricant to the thread connection. Wrench not included with carbide tip or shank purchase.

CORNER .015"R, CHAMFER .006" x 45°

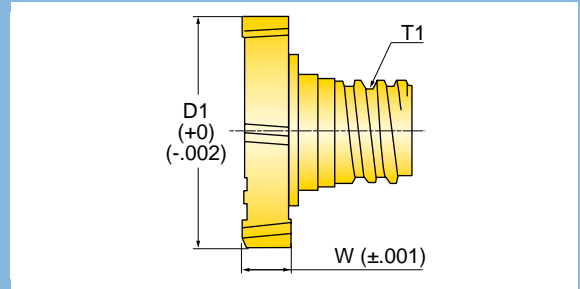

GRADES	P	M	K	N _(K)	S _(M)	H _(PK)
IN1030	+	+	+		+	○

+ Good ○ Bad



Cutter Number	# Effective	D1 Nominal Diameter	W Width	Max. Radial Depth of Cut	T1 Thread Size	C Corner	Driver Size/Torque Value (in. lbs.)
18T-5006TQRN00	6	.500	.062	.09	T05	.006 x 45°	1 / 60
18T-5012TQRN00	6	.500	.125	.09	T05	R .015	1 / 60
18T-6205T6RN02	6	.625	.056	.10	T06	R .015	1 / 90
18T-6206T6RN01	6	.625	.062	.13	T06	R .015	1 / 90
18T-6206T6RN02	6	.625	.068	.11	T06	R .015	1 / 90
18T-6208T6RN01	6	.625	.078	.13	T06	R .015	1 / 90
18T-6208T6RN02	6	.625	.086	.12	T06	R .015	1 / 90
18T-6210T6RN01	6	.625	.105	.13	T06	R .015	1 / 90
18T-6212T6RN01	6	.625	.125	.13	T06	R .015	2 / 90
18T-6216T6RN01	6	.625	.156	.13	T06	R .015	2 / 90
18T-7516T8RN01	6	.750	.156	.13	T08	R .015	3 / 130
18T-7519T8RN01	6	.750	.187	.13	T08	R .015	3 / 130
18T-7525T8RN01	6	.750	.250	.13	T08	R .015	3 / 130
18T-8718T8RN01	6	.875	.187	.19	T08	R .015	4 / 130
18T-8725T8RN01	6	.875	.250	.19	T08	R .015	4 / 130
18T-8731T8RN01	6	.875	.312	.19	T08	R .015	4 / 130
18T-10018TRRN02	6	1.000	.187	.19	T10	R .015	5 / 250
18T-10025TRRN02	6	1.000	.250	.19	T10	R .015	5 / 250
18T-10037TRRN02	6	1.000	.375	.19	T10	R .015	5 / 250

Operating guidelines on [page 410](#).

HARDWARE		
Driver Size	Torx Driver	Optional Torque Bit
1	DS-T20T	DS-T20B / .250"
2	DS-T25T	DS-T25B / .250"
3	DS-T30T	DS-T30B / .250"
4	DS-T40T	DS-T40B / .250"
5	DS-T50L	DS-T50B / .312"

When assembling, be sure carbide tip is seated firmly on shank with no gap.
 Note: DO NOT apply lubricant to the thread connection. Wrench not included with carbide tip or shank purchase.

CHIP SURFER™ PAKS FOR PRECISION T-SLOT MILLING TIP - 18T

CHIPSURFER PAKS

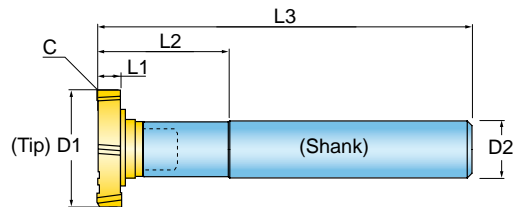

ORDER THIS PAK NUMBER	(QTY) T-Slot Tip	Straight Shank	D1 T-Slot Dia.	T-Slot Corner	D2 Shank Adaption	L1 Length of Cut	L2 Projection Length	L3 Assem. Length	Wrench
S037T06KA-06-08	(2) 18T-6208T6RN01	S037T06SA-06 (Steel)	.625	.15	.375 Cylindrical	.078	.70	3.10	DS-T20T
S037T06KA-06-18	(2) 18T-6212T6RN01	S037T06SA-06 (Steel)	.625	.15	.375 Cylindrical	.125	.75	3.15	DS-T20T
S037T06KA-06-28	(2) 18T-6216T6RN01	S037T06SA-06 (Steel)	.625	.15	.375 Cylindrical	.156	.80	3.19	DS-T20T
S050T08KA-06-38	(2) 18T-7519T8RN01	S050T08SA-06 (Steel)	.750	.15	.500 Cylindrical	.187	.85	3.72	DS-T30T
S050T08KA-06-48	(2) 18T-7525T8RN01	S050T08SA-06 (Steel)	.750	.15	.500 Cylindrical	.250	.91	3.78	DS-T30T

CHIP SURFER™ PAK FOR SNAP RING GROOVES - 18T

CONTENTS: 4 DIFFERENT TIPS, 1 SHANK AND 1 WRENCH



T-Slot Pak
(6 Flutes) Multi-Purpose, PVD - TiAlN-Coated IN1030

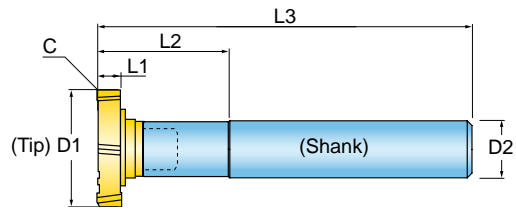

Order This Pak Number	Shank	(Qty) T-Slot Tips	L1 Width of Cut	D1 Nominal Diameter	L2 Projection Length	L3 Assm Length	Corner	D2 Shank Adaption	Wrench
S037T06KA-12-98	S037T06CA-12(Carbide)	(1) 18T-6205T6RN02	.056	.625	1.45	4.190	.015R	.375 Cyl	DS-T20T
		(1) 18T-6206T6RN02	.068						
		(1) 18T-6208T6RN02	.086						
		(1) 18T-6212T6RN01	.125						

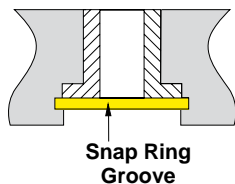

When assembling, be sure carbide tip is seated firmly on shank with no gap.
Note: DO NOT apply lubricant to the thread connection. Wrench not included with carbide tip or shank purchase.

THREAD MILL



Threading

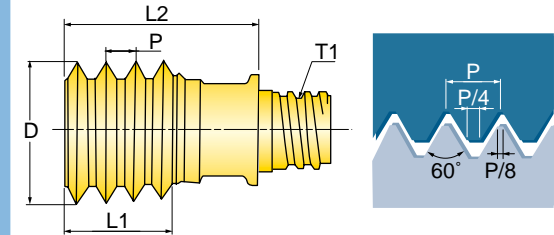

GRADES	P	M	K	N _(K)	S _(M)	H _(PK)
IN2005	+	+	+		+	

+ Good ○ Bad

INCH

Cutter Number	P Pitch (TPI)	UNC	UNF	UNEF	D Nominal Diameter	# Effective	T1 Thread Size	L1 Length of Cut	L2 Extension Length
47Y-24UNTQRA13	24	-	-	9/16 & 5/8	.394	4	T05	.252	.526
47Y-20UNTQRA13	20	-	1/2	-	.394	4	T05	.252	.526
47Y-18UNTQRA13	18	-	9/16 & 5/8	1-1/8 & 1-5/8	.394	4	T05	.220	.526
47Y-16UNT6RA17	16	-	3/4	-	.472	4	T06	.315	.671
47Y-14UNT8RA21	14	-	7/8	-	.630	5	T08	.500	.821
47Y-12UNT8RA21	12	-	1 & 1-1/2	-	.630	5	T08	.500	.821
47Y-10UNT8RA21	10	3/4	-	-	.602	4	T08	.500	.821
46Y-09UNT8RA21	9	7/8	-	-	.630	3	T08	.445	.821

METRIC

Cutter Number	P Pitch (mm)	M Coarse	M Fine	D Nominal Diameter	# Effective	T1 Thread Size	L1 Length of Cut	L2 Extension Length
47Y075ISTQRA13	.75	-	Ø≥12	.394	4	T05	.236	.526
47Y100ISTQRA13	1.0	-	Ø≥12	.394	4	T05	.236	.526
47Y150ISTQRA13	1.5	-	Ø≥14	.394	4	T05	.236	.526
47Y150IST6RA17	1.5	-	Ø≥16	.472	4	T06	.295	.671
48Y150IST8RA21	1.5	-	Ø≥20	.630	6	T08	.472	.821
47Y200IST6RA17	2.0	M16	Ø≥17	.472	4	T06	.315	.671
47Y200IST8RA21	2.0	-	Ø≥19	.630	5	T08	.472	.821
47Y250IST8RA20	2.5	M20	Ø≥22	.606	5	T08	.492	.821
46Y300IST8RA21	3.0	M24	Ø≥25	.630	3	T08	.472	.821

Operating guidelines on [page 408](#).

HARDWARE



Thread Size

Wrench

Optional Torque Wrench

T05	WS-0043	DT-60-06
T06	WS-0029	DT-90-08
T08	WS-0030	DT-130-10

When assembling, be sure carbide tip is seated firmly on shank with no gap.

Note: DO NOT apply lubricant to the thread connection. Wrench not included with carbide tip or shank purchase.

CHIP SURFER™ CENTER DRILL - 45Z

120° INCLUDED POINT ANGLE, 10°-15° HELICAL FLUTE

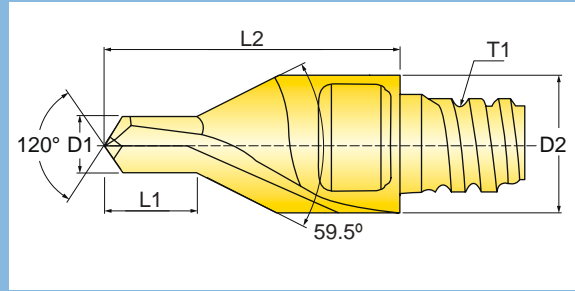

GRADES	P	M	K	N _(K)	S _(M)	H _(PK)
IN2005	+	+	+	○	+	

+ Good ○ Bad



Cutter Number	Size Designation (ANSI B94)	D1 Drill Diameter	D2 Flange Diameter	T1 Thread Size	L1 Drill Length	L2 Extension Length
45Z03208TQRA15	#4	0.129	0.315	T5	0.181	0.59
45Z-1851T8RA09	#5	0.187	0.500*	T8	0.242	0.90
45Z-2152T8RA09	#6	0.218	0.500	T8	0.281	0.90
45Z06517TRRA28	#7	0.254	0.630	T10	0.350	1.10

*Diameter is larger than ANSI standard.
Operating guidelines on [page 407](#).

HARDWARE		
Thread Size	Wrench	Optional Torque Wrench
T05	WS-0043	DT-60-06
T08	WS-0030	DT-130-10
T10	WS-0044	DT-250-13

When assembling, be sure carbide tip is seated firmly on shank with no gap.
Note: DO NOT apply lubricant to the thread connection. Wrench not included with carbide tip or shank purchase.

CHIP SURFER™ 0 DEGREE LEAD END MILL - 12J1D

DIAMETERS
.375" TO .750"

MAX. DEPTH OF CUT
.22"

INSERT CORNER
.008", .015", .031" AND .062" R



Shoulder



Channeling



Ramping



Corkscrew



Pocketing



Facing

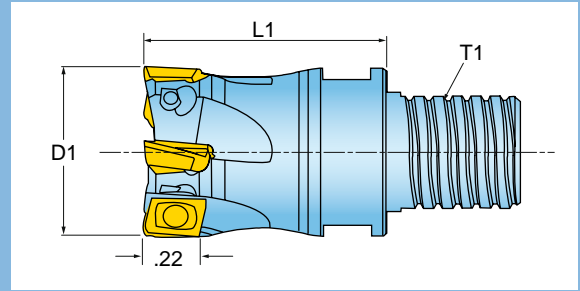

Cutter Number	D1 Nominal Diameter	# Inserts	T1 Thread Size	L1 Extension Length	Ramp Angle
12J1D-03006T6R01	.375	2	T06	0.625	9.6
12J1D-05006T8R01	.500	2	T08	0.650	6.0
12J1D-05006T8R02	.500	3	T08	0.650	6.0
12J1D-06008TRR01	.625	4	T10	0.800	4.0
12J1D-07010TSR01	.750	5	T12	1.000	2.6
12J1D-07010TSR02	.750	3	T12	1.000	2.6

Operating guidelines on [page 347](#).

Thread Size	HARDWARE	
	Wrench	Optional Torque Wrench
T06	WS-0029	DT-90-08
T08	WS-0030	DT-130-10
T10	WS-0044	DT-250-13
T12	WS-0059	DT-250-16

When assembling, be sure carbide tip is seated firmly on shank with no gap.

Note: DO NOT apply lubricant to the thread connection. Wrench not included with carbide tip or shank purchase.

INSERTS

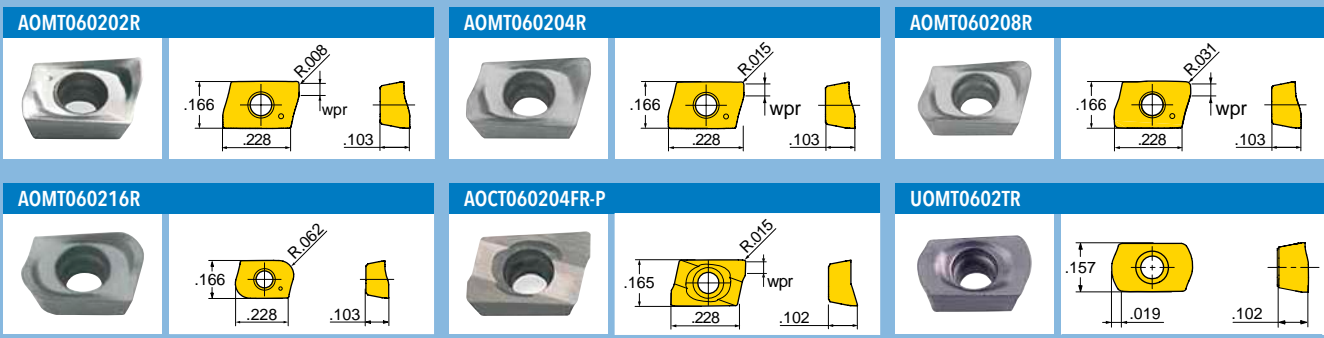

Insert Number	Application	Corner	GRADE	IN2005	IN2030	IN1030	IN05S	IN2505				
AOMT060202R	Multi-Purpose	.008r		●	●	●						
AOMT060204R	Multi-Purpose	.015r		●	●							
AOMT060208R	Multi-Purpose	.031r		●	●							
AOMT060216R*	Multi-Purpose	.062r		●	●							
AOCT060204FR-P	Ground/Polished (for Alum.)	.015r					●					
UOMT0602TR	Hi Feed	.040r			●			●				

* Cutter body should be relieved to accept .062"R insert.

● = P ● = M ● = K ● = N ● = S ○ = H

HARDWARE				
	SM18-041-00	DS-TP06S (Tx Plus 06)	DTN005S	DS-TP06TB

0 DEGREE LEAD END MILL

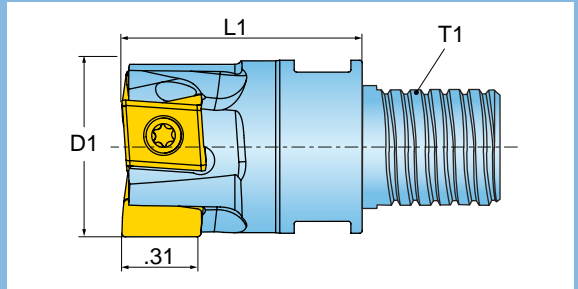

Cutter Number	D1 Nominal Diameter	T1 Adaption	L1 Extension Length	Number of Inserts
1SJ1Y-07010TSR01	0.750	T12	1.00	3
1SJ1Y-10012TUR01	1.000	T15	1.25	4

Operating guidelines on [page 355](#).

INSERTS

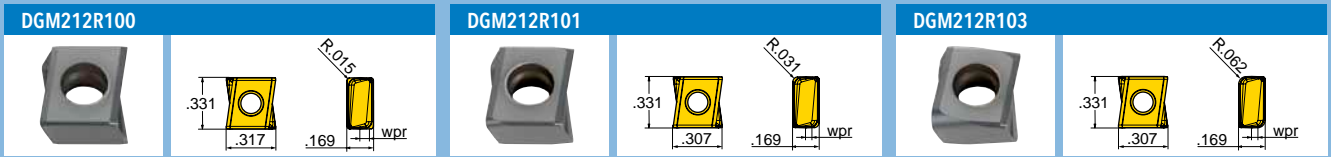

Part Number	Applications	Grade						
			IN2005	IN2015	IN2030			
DGM212R100	Multi-Purpose - 0.015" R		●	●	●			
DGM212R101	Multi-Purpose - 0.031" R		●	●	●			
DGM212R103	Multi-Purpose - 0.062" R		●	●	●			

● = P ● = M ● = K ● = N ● = S

HARDWARE

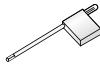

Insert Screw

Driver

Wrench

Optional Torque Wrench

1SJ1Y-07010TSR01	SM30-074-21	DS-T08W	WS-0059	DT-250-16
1SJ1Y-10012TUR01	SM30-082-21	DS-T08W	WS-0061	-

PROBALL™ BALL NOSE END MILL (CHIP-SURFER STYLE) - 1BW7

DIAMETERS
.500" TO .750"

DEPTH OF CUT
.250" TO .375"

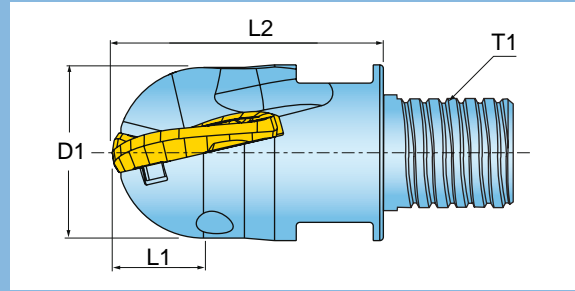
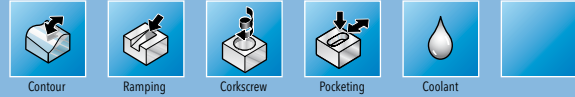

Cutter Number	D1 Nominal Diameter	L1 Depth of Cut	L2 Extension Length	T1 Thread Size
1BW7T-05007T8R01	.500	0.250	.750	T08
1BW7V-07010TSR01	.750	0.375	1.000	T12

Operating guidelines on [page 379](#).

Thread Size	HARDWARE	
	Wrench	Optional Torque Wrench
T08	WS-0030	DT-130-10
T12	WS-0059	DT-250-16

When assembling, be sure carbide tip is seated firmly on shank with no gap.

Note: DO NOT apply lubricant to the thread connection. Wrench not included with carbide tip or shank purchase.

INSERTS

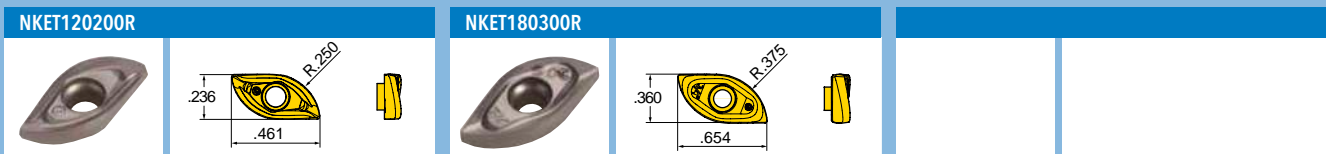

Cutter Diameter	Insert Number	Insert Radius	Number of Indexes	GRADE	IN2005	IN2030						
.500	NKET120200R	0.250	2		●	●						
.750	NKET180300R	0.375	2		●	●						

● = P ● = M ● = K ● = N ● = S ○ = H

HARDWARE	Insert Screw		Torx Driver	
		SM25-052-80	DS-0038	
	SM30-080-10	DS-0022		

CHIP SURFER™ NECKED DOWN STRAIGHT SHANKS

THREAD CONNECTIONS
T05, T06, T08, T10, T12 AND T15

SHANK MATERIALS
CARBIDE, STEEL, HEAVY METAL

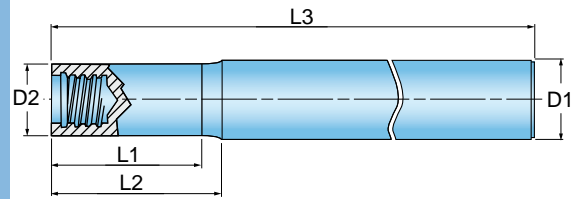

T1 Thread Size	Part Number	L1 Projection Length	L2 Extension Length	L3 Overall Length	D1 Shank Diameter	D2 Mating Diameter
STEEL SHANKS						
T05	S031T05SA-05	.51	.59	2.50	.312 CYL	.300
T06	S037T06SA-06	.50	.60	3.00	.375 CYL	.364
T08	S050T08SA-06	.53	.63	3.50	.500 CYL	.480
T08	*S050T08SA-061	.53	.63	3.50	.500 CYL	.455
T10	S075T10SA-00	-	.13	2.75	.750 CYL	.750
T10	S062T10SA-06	.68	.78	4.00	.625 CYL	.600
T12	S075T12SA-08	.88	1.00	5.00	.750 CYL	.720
T12	WB100T12SA-00	-	.24	3.00	1.000 WELDON	.720
T15	S100T15SA-13	1.30	1.40	5.30	1.000 CYL	.940
T15	WB125T15SA-00	-	.35	4.00	1.250 WELDON	.940

T1 Thread Size	Part Number	L1 Projection Length	L2 Extension Length	L3 Overall Length	D1 Shank Diameter	D2 Mating Diameter
CARBIDE SHANKS						
T05	S031T05CA-09	.95	1.00	3.00	.312 CYL	.300
T05	S031T05CA-19	1.95	2.00	4.00	.312 CYL	.300
T06	S037T06CA-12	1.20	1.25	4.00	.375 CYL	.364
T06	S037T06CA-20	1.95	2.00	4.75	.375 CYL	.364
T08	S012T08CA040	1.52	1.57	3.54	12mm CYL	.455
T08	S012T08CA080	3.10	3.15	5.12	12mm CYL	.455
T08	S050T08CA-15	1.45	1.50	4.00	.500 CYL	.480
T08	*S050T08CA-151	1.45	1.50	4.00	.500 CYL	.455
T08	S050T08CA-25	2.45	2.50	5.50	.500 CYL	.480
T08	*S050T08CA-251	2.45	2.50	5.50	.500 CYL	.455
T10	S062T10CA-34	3.43	3.50	5.50	.625 CYL	.600
T10	S062T10CA-49	4.93	5.00	7.00	.625 CYL	.600
T12	S075T12CA-14	1.43	1.50	4.00	.750 CYL	.720
T12	S075T12CA-29	2.93	3.00	5.50	.750 CYL	.720
T12	S075T12CA-44	4.43	4.50	8.00	.750 CYL	.720
T15	S100T15CA-24	2.40	2.50	5.00	1.000 CYL	.940
T15	S100T15CA-39	3.90	4.00	7.00	1.000 CYL	.940

*Necked down shanks for 12mm tips.

T1 Thread Size	Part Number	L1 Projection Length	L2 Extension Length	L3 Overall Length	D1 Shank Diameter	D2 Mating Diameter
HEAVY METAL SHANKS w/Coolant						
T08	S012T08HA040	1.55	1.57	3.54	12mm CYL	.455

When assembling, be sure carbide tip is seated firmly on shank with no gap.
Note: DO NOT apply lubricant to the thread connection.

CHIP SURFER™ CONICAL SHANKS

THREAD CONNECTIONS
T05, T06, T08, T10, T12 AND T15

SHANK MATERIALS
CARBIDE OR STEEL

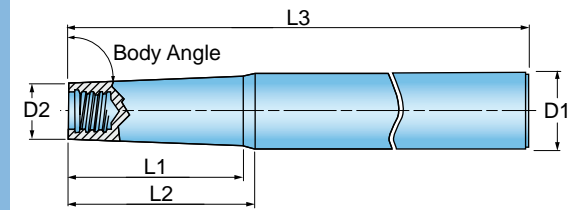

T1 Thread Size	° Body Angle	Part Number	L1 Projection Length	L2 Extension Length	L3 Overall Length	D1 Shank Diameter	D2 Mating Diameter
STEEL SHANKS							
T06	85°	S062T06SK-13	1.25	1.37	5.00	.625 CYL	.364
T06	89°	S062T06SK-21	1.75	2.15	6.30	.625 CYL	.364
T08	85°	S062T08SK-08	.75	.85	5.50	.625 CYL	.480
T08	89°	S075T08SK-31	2.75	3.15	6.50	.750 CYL	.480
T12	85°	S100T12SK-16	-	1.60	6.30	1.000 CYL	.720
T12	89°	S100T12SK-34	3.40	3.75	8.00	1.000 CYL	.720
T12	85°	S125T12SK-31	-	3.15	7.50	1.250 CYL	.720
T15	85°	WB150T15SK-34	-	3.40	10.00	1.500 WELDON	.940
T15	85°	S125T15SK-18	-	1.80	8.00	1.250 CYL	.940
T15	89°	S125T15SK-40	-	4.00	10.00	1.250 CYL	.940

T1 Thread Size	° Body Angle	Part Number	L1 Projection Length	L2 Extension Length	L3 Overall Length	D1 Shank Diameter	D2 Mating Diameter
CARBIDE SHANKS							
T05	89°	S037T05CK-15	-	1.50	3.50	.375 CYL	.300
T05	89°	S062T05CK-39	3.90	4.00	6.00	.625 CYL	.300
T06	88.5°	S050T06CK-25	2.50	2.50	5.50	.500 CYL	.364
T06	88.5°	S062T06CK-35	3.37	3.50	6.50	.625 CYL	.364
T08	89°	S062T08CK-35	3.45	3.50	6.50	.625 CYL	.480
T08	88.5°	S075T08CK-40	3.90	4.00	7.00	.750 CYL	.480
T10	89°	S075T10CK-40	-	4.00	6.50	.750 CYL	.600
T10	89°	S075T10CK-62	6.24	6.30	8.80	.750 CYL	.600
T12	89°	S100T12CK-55	-	5.50	10.00	1.000 CYL	.720
T15	89°	S125T15CK-50	-	5.00	8.00	1.250 CYL	.940
T15	89°	S125T15CK-80	-	8.00	12.00	1.250 CYL	.940

When assembling, be sure carbide tip is seated firmly on shank with no gap.
Note: DO NOT apply lubricant to the thread connection.

CHIP SURFER™ STRAIGHT SHANKS WITH NO NECK

THREAD CONNECTIONS
T05, T06, T08, T10 AND T12

SHANK MATERIALS
CARBIDE, STEEL, HEAVY METAL

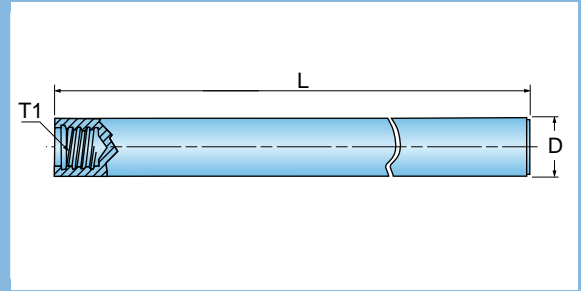

T1 Thread Size	Part Number	L Length	D Shank Diameter
CARBIDE SHANKS			
T05	S031T05CA-40	4.00	.312 CYL
T05	S031T05CA-65	6.50	.312 CYL
T06	S037T06CA-40	4.00	.375 CYL
T06	S037T06CA-70	7.00	.375 CYL
T08	S050T08CA-40	4.00	.500 CYL
T08	S050T08CA-75	7.50	.500 CYL
T10	S062T10CA-40	4.00	.625 CYL
T10	S062T10CA-80	8.00	.625 CYL
T12	S075T12CA-40	4.00	.750 CYL
T12	S075T12CA-80	8.00	.750 CYL

T1 Thread Size	Part Number	L Length	D Shank Diameter
STEEL SHANKS			
T05	S031T05SA-27	2.75	.312 CYL
T06	S037T06SA-21	2.13	.375 CYL
T06	S037T06SA-32	3.25	.375 CYL
T08	S050T08SA-37	3.75	.500 CYL
T10	S062T10SA-40	4.00	.625 CYL

T1 Thread Size	Part Number	L Length	D Shank Diameter
HEAVY METAL SHANKS w/Coolant			
T05	S031T05HA-35	3.50	.312 CYL
T06	S037T06HA-45	4.50	.375 CYL
T08	S012T08HA078	3.94	12mm CYL
T08	S050T08HA-55	5.50	.500 CYL
T10	S062T10HA-65	6.50	.625 CYL
T12	S075T12HA-75	7.50	.750 CYL

When assembling, be sure carbide tip is seated firmly on shank with no gap.
Note: DO NOT apply lubricant to the thread connection.

CHIPSURFER™ INTEGRAL ER-ADAPTOR

THREAD CONNECTIONS
T05, T06, T08, T10, T12 AND T15

SHANK MATERIALS
STEEL

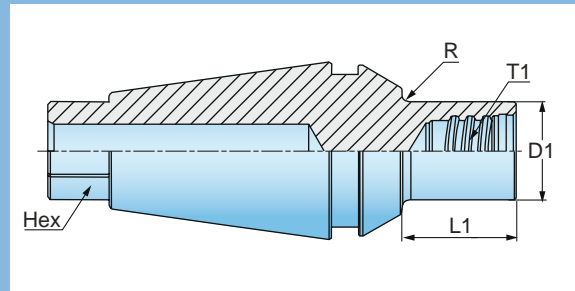

Part Number	ER Size	T1 Thread Size (End Mill Dia)	L1 Length	D1 Diameter	Hex	R	Coolant
ER11T05SA-02	11	T05 (.312)	0.157	.300	0.312	-	-
ER11T05SA-05	11	T05 (.312)	0.413	.300	0.312	-	-
ER16T05SA-02	16	T05 (.312)	0.157	.300	0.312	0.03	-
ER16T05SA-05	16	T05 (.312)	0.413	.300	0.312	0.03	-
ER16T06SA-02	16	T06 (.375)	0.157	.354	0.312	0.03	-
ER16T06SA-05	16	T06 (.375)	0.413	.354	0.312	0.03	-
ER16T08SA-02	16	T08 (.500)	0.157	.472	0.312	-	-
ER16T08SA-06	16	T08 (.500)	0.512	.472	0.312	-	-
ER20T05SA-02	20	T05 (.312)	0.157	.300	0.437	0.03	-
ER20T05SA-05	20	T05 (.312)	0.413	.300	0.437	0.03	-
ER20T06SA-02	20	T06 (.375)	0.157	.354	0.437	0.03	-
ER20T06SA-05	20	T06 (.375)	0.413	.354	0.437	0.03	-
ER20T08SA-02	20	T08 (.500)	0.157	.472	0.437	0.03	-
ER20T08SA-06	20	T08 (.500)	0.512	.472	0.437	0.03	-
ER20T10SA-02	20	T10 (.625)	0.157	.598	0.437	-	-
ER20T10SA-07	20	T10 (.625)	0.630	.598	0.437	-	-
ER32T05SA-10	32	T05 (.312)	0.984	.300	0.750	0.20	Yes
ER32T05SA-20	32	T05 (.312)	1.968	.300	0.750	0.32	Yes
ER32T06SA-10	32	T06 (.375)	0.984	.354	0.750	0.20	Yes
ER32T06SA-20	32	T06 (.375)	1.968	.354	0.750	0.24	Yes
ER32T08SA-10	32	T08 (.500)	0.984	.472	0.750	0.08	Yes
ER32T08SA-20	32	T08 (.500)	1.968	.472	0.750	0.20	Yes
ER32T10SA-10	32	T10 (.625)	0.984	.598	0.750	0.08	Yes
ER32T10SA-20	32	T10 (.625)	1.968	.598	0.750	0.12	Yes
ER32T12SA-10	32	T12 (.750)	0.984	.700	0.750	0.12	Yes
ER32T12SA-20	32	T12 (.750)	1.968	.700	0.750	0.12	Yes
ER32T15SA-10	32	T15 (1.000)	0.984	.950	0.750	0.03	Yes
ER32T15SA-20	32	T15 (1.000)	1.968	.950	0.750	0.03	Yes

When assembling, be sure carbide tip is seated firmly on shank with no gap.
Note: DO NOT apply lubricant to the thread connection.

THREAD CONNECTIONS T05, T06, T08, T10 AND T12

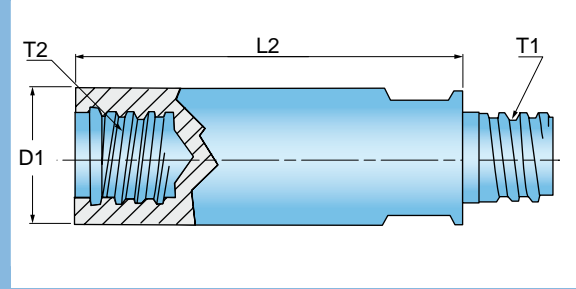

Part Number	D1 Nominal Diameter	T1 Thread Size	T2 Female Thread	L Extension Length
T05T05SA-10	.300	T05	T05	1.000
T06T06SA-10	.366	T06	T06	1.000
T08T08SA-10	.453	T08	T08	1.000
T10T10SA-15	.600	T10	T10	1.500
T12T12SA-15	.720	T12	T12	1.500
T15T15SA-17	.940	T15	T15	1.770

Thread Size	HARDWARE	
	Wrench	Optional Torque Wrench
T05	WS-0043	DT-60-06
T06	WS-0029	DT-90-08
T08	WS-0030	DT-130-10
T10	WS-0044	DT-250-13
T12	WS-0059	DT-250-16
T15	WS-0061	-

When assembling, be sure carbide tip is seated firmly on shank with no gap.
Note: DO NOT apply lubricant to the thread connection. Wrench not included with carbide tip or shank purchase.

THREAD SIZE
T05, T06, T08, T10, T12 AND T15

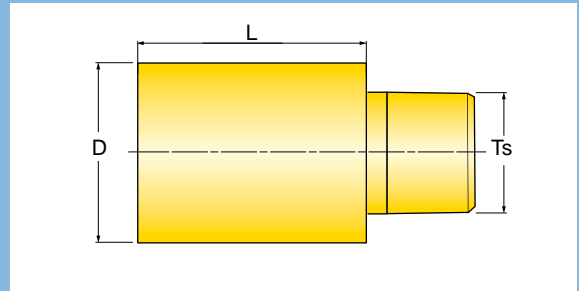

GRADES	P	M	K	N _(K)	S _(M)	H _(PK)
IN05S	+	+	+	+	+	+

+ Good ○ Bad



D Diameter	Part Number	L Length	Ts Thread Size
.315	4RJ08000TQ-S100	.407	T05
.394	4RJ10000T6-S140	.525	T06
.501	4RJ-5000T8-S060	.670	T08
.630	4RJ16000TR-S210	.820	T10
.787	4RJ20000TS-S260	1.025	T12
1.001	4RJ-1000TU-S140	1.475	T15



CHIP SURFER™ BALL NOSE BLANKS

THREAD SIZE
T05, T06, T08 AND T10

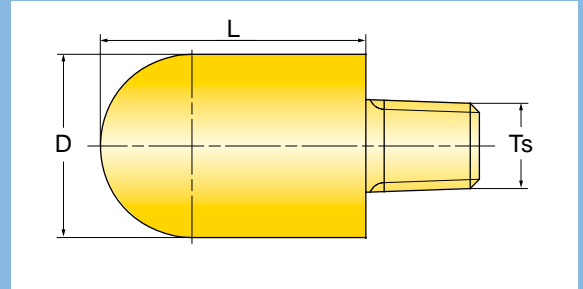

GRADES	P	M	K	N _(K)	S _(M)	H _(P/K)
IN05S	+	+	+	+	+	+

+ Good ○ Bad



D Diameter	Part Number	L Length	Ts Thread Size
.315	4RB08000TQ-S100	.407	T05
.394	4RB10000T6-S140	.525	T06
.501	4RB-5000T8-S060	.670	T08
.630	4RB16000TR-S210	.820	T10

CHIP SURFER™ T-SLOT PREFORM BLANKS

THREAD SIZE
T05, T06, T08 AND T10

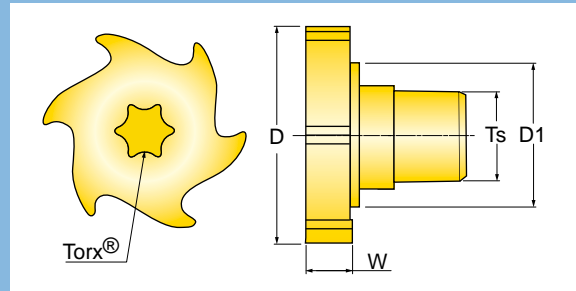

GRADES

IN30M

P	M	K	N _(K)	S _(M)	H _(PK)
+	+	+	+	+	○

+ Good ○ Bad



D Nominal Diameter	Part Number	W Width	Ts Thread Size	D1 Hub Diameter	Torx	Number of Teeth
.551	18T14019TQRS000	.075	T05	.320	T20	6
.551	18T14028TQRS000	.110	T05	.320	T20	6
.551	18T14033TQRS000	.130	T05	.320	T20	6
.551	18T14043TQRS000	.169	T05	.320	T20	6
.641	18T16323T6RS000	.090	T06	.364	T20	6
.641	18T16333T6RS000	.130	T06	.364	T25	6
.641	18T16343T6RS000	.169	T06	.364	T25	6
.762	18T19439T8RS000	.149	T08	.480	T30	6
.762	18T19444T8RS000	.173	T08	.480	T30	6
.762	18T19451T8RS000	.200	T08	.480	T30	6
.762	18T19467T8RS000	.263	T08	.480	T30	6
.779	18T19844T8RS000	.173	T08	.480	T30	6
.779	18T19854T8RS000	.212	T08	.480	T30	6
.779	18T19863T8RS000	.251	T08	.480	T30	6
.919	18T23453T8RS000	.208	T08	.480	T40	6
.919	18T23463T8RS000	.248	T08	.480	T40	6
.919	18T23483T8RS000	.327	T08	.480	T40	6
.919	18T23499T8RS000	.387	T08	.480	T40	6
1.015	18T25826TRRS000	.102	T10	.630	T50	6
1.015	18T25840TRRS000	.157	T10	.630	T50	6
1.015	18T25850TRRS000	.197	T10	.630	T50	6
1.015	18T25866TRRS000	.260	T10	.630	T50	6
1.015	18T25883TRRS000	.327	T10	.630	T50	6
1.015	18T25899TRRS000	.390	T10	.630	T50	6
1.125	18T28628TRRS000	.110	T10	.630	T40	6
1.125	18T28636TRRS000	.141	T10	.630	T40	6
1.125	18T28656TRRS000	.220	T10	.630	T40	6
1.125	18T28610TRRS000	.405	T10	.630	T40	6

Allow up to .015" on diameter for grind stock.
Operating guidelines on [page 410](#).



CHIP SURFER™ WRENCH KIT



6 DIFFERENT WRENCHES



ORDER THIS Pak Number	(QTY) Wrench P/N	Wrench Opening Sizes (mm)
KIT CHIP SURFER WRENCH	(1) WS-0043	4 and 6
	(1) WS-0029	5 and 8
	(1) WS-0030	7 and 10
	(1) WS-0044	8 and 13
	(1) WS-0059	9 and 16
	(1) WS-0061	20

NOTES

A large rectangular area with a light blue background and horizontal blue stripes, intended for taking notes.

ROUGHING END MILLS, 3-FLUTE, 38 DEGREE HELIX, W/CHIPSPLITTERS

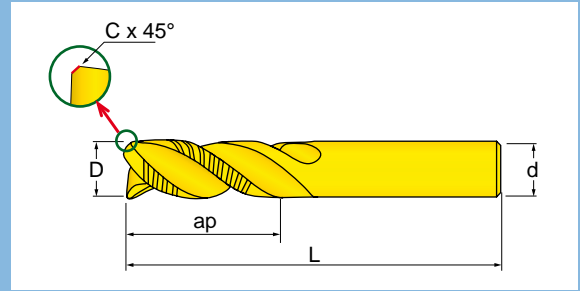

Grade	P	M	K	N _(K)	S _(M)	H _(PK)
IN2005	+	+	+		+	

	e9
	h6



+ Preferred choice ○ Second choice

Cutter Number	Grade	Helix (deg)	D Diameter	Z Flutes	C Chamfer	L Overall Length	Ap Cut Length	d Shank Size/Style
46C-2505R6RM00	IN2005	38.0	0.250	3	.010x45	2.50	0.50	.250" Cylindrical
46C-3106R7RM01	IN2005	38.0	0.312	3	.015x45	2.50	0.63	.312" Cylindrical
46C-3707R8RM01	IN2005	38.0	0.375	3	.015x45	3.00	0.75	.375" Cylindrical
46C-5010S4RM01	IN2005	38.0	0.500	3	.020x45	3.50	1.00	.500" Cylindrical
46C-6212S6RM02	IN2005	38.0	0.625	3	.020x45	3.50	1.25	.625" Cylindrical
46C-7515S7RM02	IN2005	38.0	0.750	3	.020x45	4.00	1.50	.750" Cylindrical
46C-1020S1RM02	IN2005	38.0	1.000	3	.024x45	6.00	2.00	1.000" Cylindrical

Operating guidelines on [page 402](#).

POWERROUNDS™ SERIES 47J_RD, 48J_RD

PRECISION END MILLS, MEDIUM & LONG LENGTH, 45 DEGREE HELIX



Shoulder



Ramping



Corkscrew

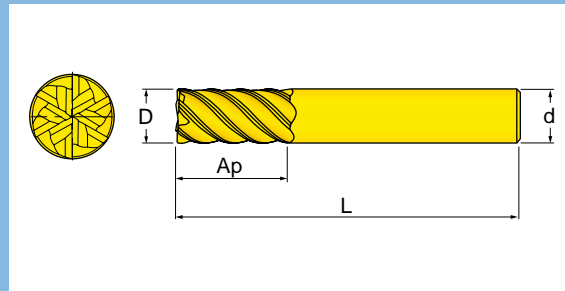

Grade	P	M	K	N _(K)	S _(M)	H _(PK)
IN2005	+	+	+		+	

	e8
	h6



+ Preferred choice ○ Second choice

Cutter Number	Length	Helix (deg)	D Diameter	Z Flutes	C Corner	L Overall Length	Ap Cut Length	d Shank Size/Style	
47J-1203R4RD15	IN2005	Medium	45	0.125	4	Sharp	1.50	0.37	.125" Cylindrical
47J-1805R5RD20	IN2005	Medium	45	0.188	4	Sharp	2.00	0.50	.188" Cylindrical
47J-2506R6RD25	IN2005	Medium	45	0.250	4	Sharp	2.50	0.62	.250" Cylindrical
47J-3107R7RD25	IN2005	Medium	45	0.312	4	Sharp	2.50	0.75	.312" Cylindrical
47J-3708R8RD25	IN2005	Medium	45	0.375	4	Sharp	2.50	0.87	.375" Cylindrical
47J-4310R9RD27	IN2005	Medium	45	0.437	4	Sharp	2.75	1.00	.438" Cylindrical
47J-5010S4RD30	IN2005	Medium	45	0.500	4	Sharp	3.00	1.00	.500" Cylindrical
47J-6212S6RD35	IN2005	Medium	45	0.625	4	Sharp	3.50	1.25	.625" Cylindrical
47J-7515S7RD40	IN2005	Medium	45	0.750	4	Sharp	4.00	1.50	.750" Cylindrical
48J-2506R6RD25	IN2005	Medium	45	0.250	6	Sharp	2.50	0.62	.250" Cylindrical
48J-2510R6RD30	IN2005	Long	45	0.250	6	Sharp	3.00	1.00	.250" Cylindrical
48J-3107R7RD25	IN2005	Medium	45	0.312	6	Sharp	2.50	0.75	.312" Cylindrical
48J-3112R7RD30	IN2005	Long	45	0.312	6	Sharp	3.00	1.25	.312" Cylindrical
48J-3708R8RD25	IN2005	Medium	45	0.375	6	Sharp	3.00	0.87	.375" Cylindrical
48J-3715R8RD40	IN2005	Long	45	0.375	6	Sharp	4.00	1.50	.375" Cylindrical
48J-4310R9RD30	IN2005	Medium	45	0.438	6	Sharp	3.00	1.00	.438" Cylindrical
48J-5010S4RD30	IN2005	Medium	45	0.500	6	Sharp	3.00	1.00	.500" Cylindrical
48J-5020S4RD42	IN2005	Long	45	0.500	6	Sharp	4.25	2.00	.500" Cylindrical
48J-6212S6RD35	IN2005	Medium	45	0.625	6	Sharp	3.50	1.25	.625" Cylindrical
48J-6225S6RD50	IN2005	Long	45	0.625	6	Sharp	5.00	2.50	.625" Cylindrical
48J-7515S7RD40	IN2005	Medium	45	0.750	6	Sharp	4.00	1.50	.750" Cylindrical
48J-7525S7RD50	IN2005	Long	45	0.750	6	Sharp	5.00	2.50	.750" Cylindrical
48J-1017S1RD45	IN2005	Medium	45	1.000	6	Sharp	4.50	1.75	1.000" Cylindrical

Operating guidelines on [page 402](#).

PRECISION END MILLS FOR ALUMINUM, 45 DEGREE HELIX

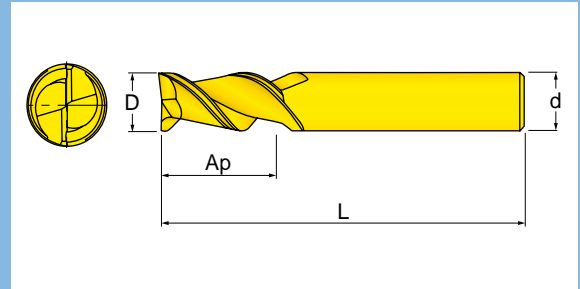

Grade	P	M	K	N _(K)	S _(M)	H _(PK)
IN05S				+		

	h6
	h6



+ Preferred choice ○ Second choice

Cutter Number	Length	Helix (deg)	D Diameter	Z Flutes	C Corner	L Overall Length	Ap Cut Length	d Shank Size/Style	
45J-2505R6RD25	IN05S	Medium	45	0.250	2	Sharp	2.50	0.50	.250" Cylindrical
45J-3106R7RD25	IN05S	Medium	45	0.312	2	Sharp	2.50	0.63	.312" Cylindrical
45J-3707R8RD30	IN05S	Medium	45	0.375	2	Sharp	3.00	0.75	.375" Cylindrical
45J-5010S4RD30	IN05S	Medium	45	0.500	2	Sharp	3.00	1.00	.500" Cylindrical
45J-6210S6RD35	IN05S	Medium	45	0.625	2	Sharp	3.50	1.00	.625" Cylindrical
45J-7512S7RD40	IN05S	Medium	45	0.750	2	Sharp	4.00	1.25	.750" Cylindrical
45J-1015S1RD45	IN05S	Medium	45	1.000	2	Sharp	4.50	1.50	1.000" Cylindrical
46J-2505R6RD25	IN05S	Medium	45	0.250	3	.008	2.50	0.50	.250" Cylindrical
46J-3106R7RD25	IN05S	Medium	45	0.312	3	.008	2.50	0.63	.312" Cylindrical
46J-3707R8RD30	IN05S	Medium	45	0.375	3	.008	3.00	0.75	.375" Cylindrical
46J-5010S4RD35	IN05S	Medium	45	0.500	3	.008	3.50	1.00	.500" Cylindrical
46J-6210S6RD35	IN05S	Medium	45	0.625	3	.008	3.50	1.00	.625" Cylindrical
46J-7512S7RD40	IN05S	Medium	45	0.750	3	.008	4.00	1.25	.750" Cylindrical
46J-1015S1RD45	IN05S	Medium	45	1.000	3	.008	4.50	1.50	1.000" Cylindrical

Operating guidelines on [page 402](#).

PRECISION CENTER-CUTTING END MILLS, 2-FLUTE, 30 DEGREE HELIX

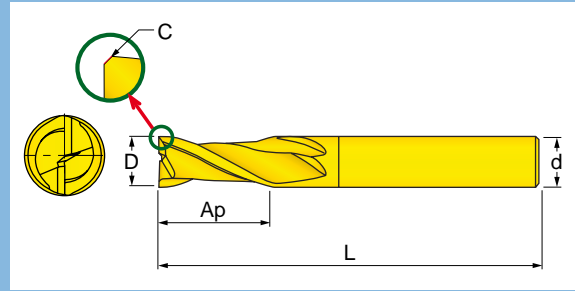

Grade	P	M	K	N _(K)	S _(M)	H _(PK)
IN2005	+	+	+		+	

	e8
	h6



+ Preferred choice ○ Second choice

Cutter Number	Grade	Helix (deg)	D Diameter	Z Flutes	C Chamfer	L Overall Length	Ap Cut Length	d Shank Size/Style
45C-1205R4RB00	IN2005	30.0	0.125	2	0.040-0.010 x 45	1.50	0.50	.125" Cylindrical
45C-1803R5RB00	IN2005	30.0	0.188	2	0.040-0.010 x 45	2.00	0.38	.188" Cylindrical
45C-2505R6RB00	IN2005	30.0	0.250	2	0.040-0.010 x 45	2.50	0.50	.250" Cylindrical
45C-2507R6RB00	IN2005	30.0	0.250	2	0.040-0.010 x 45	2.50	0.75	.250" Cylindrical
45C-3108R7RB00	IN2005	30.0	0.312	2	0.040-0.010 x 45	2.50	0.81	.312" Cylindrical
45C-3707R8RB00	IN2005	30.0	0.375	2	0.040-0.010 x 45	2.50	0.75	.375" Cylindrical
45C-370777RB00	IN2005	30.0	0.375	2	0.040-0.010 x 45	2.50	0.75	.375" Weldon
45C-3710R8RB00	IN2005	30.0	0.375	2	0.040-0.010 x 45	2.50	1.00	.375" Cylindrical
45C-4310R9RB00	IN2005	30.0	0.437	2	0.040-0.010 x 45	2.75	1.00	.438" Cylindrical
45C-5010S4RB00	IN2005	30.0	0.500	2	0.040-0.010 x 45	3.00	1.00	.500" Cylindrical
45C-501078RB00	IN2005	30.0	0.500	2	0.040-0.010 x 45	3.00	1.00	.500" Weldon
45C-6210S6RB00	IN2005	30.0	0.625	2	0.040-0.010 x 45	3.50	1.00	.625" Cylindrical
45C-7584S7RB00	IN2005	30.0	0.750	2	0.040-0.010 x 45	4.00	1.25	.750" Cylindrical

Operating guidelines on [page 402](#).

PRECISION CENTER-CUTTING END MILLS, 4-FLUTE, 38 DEGREE HELIX

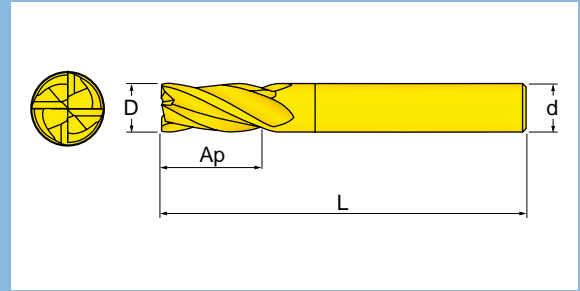
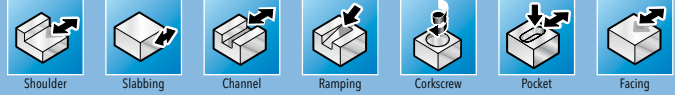

Grade	P	M	K	N _(K)	S _(M)	H _(PK)
IN2005	+	+	+		+	

	e8
	h6



+ Preferred choice ○ Second choice

Cutter Number	Grade	Helix (deg)	D Diameter	Z Flutes	C Corner	L Overall Length	Ap Cut Length	d Shank Size/Style
47J-1203R4RC15	IN2005	38.0	0.125	4	Sharp	1.50	0.38	.125" Cylindrical
47D-1203R4RC001	IN2005	38.0	0.125	4	.010	1.50	0.38	.125" Cylindrical
47J-1503R2RC15	IN2005	38.0	0.156	4	Sharp	1.50	0.38	.156" Cylindrical
47D-1203R4RC00	IN2005	38.0	0.156	4	.010	1.50	0.38	.156" Cylindrical
47J-1803R5RC15	IN2005	38.0	0.188	4	Sharp	2.00	0.38	.188" Cylindrical
47D-1203R5RC00	IN2005	38.0	0.188	4	.010	2.00	0.38	.188" Cylindrical
47J-2103R3RC20	IN2005	38.0	0.218	4	Sharp	2.00	0.38	.218" Cylindrical
47D-2103R3RC00	IN2005	38.0	0.218	4	.010	2.00	0.38	.218" Cylindrical
47J-2505R6RC25	IN2005	38.0	0.250	4	Sharp	2.50	0.50	.250" Cylindrical
47D-2505R6RC00	IN2005	38.0	0.250	4	.010	2.50	0.50	.250" Cylindrical
47D-2505R6RC02	IN2005	38.0	0.250	4	.020	2.50	0.50	.250" Cylindrical
47D-2505R6RC03	IN2005	38.0	0.250	4	.030	2.50	0.50	.250" Cylindrical
47D-2505R6RC06	IN2005	38.0	0.250	4	.060	2.50	0.50	.250" Cylindrical
47J-3106R7RC25	IN2005	38.0	0.312	4	Sharp	2.50	0.63	.312" Cylindrical
47D-3106R7RC00	IN2005	38.0	0.312	4	.010	2.50	0.63	.312" Cylindrical
47D-3106R7RC02	IN2005	38.0	0.312	4	.020	2.50	0.63	.312" Cylindrical
47D-3106R7RC03	IN2005	38.0	0.312	4	.030	2.50	0.63	.312" Cylindrical
47D-3106R7RC06	IN2005	38.0	0.312	4	.060	2.50	0.63	.312" Cylindrical
47J-3707R8RC25	IN2005	38.0	0.375	4	Sharp	2.50	0.75	.375" Cylindrical
47J-370777RC25	IN2005	38.0	0.375	4	Sharp	2.50	0.75	.375" Weldon
47D-3707R8RC00	IN2005	38.0	0.375	4	.010	2.50	0.75	.375" Cylindrical
47D-3707R8RC02	IN2005	38.0	0.375	4	.020	2.50	0.75	.375" Cylindrical
47J-3707R8RC03	IN2005	38.0	0.375	4	.030	2.50	0.75	.375" Cylindrical
47J-3707R8RC06	IN2005	38.0	0.375	4	.060	2.50	0.75	.375" Cylindrical
47D-4307R9RC27	IN2005	38.0	0.438	4	Sharp	2.75	0.75	.438" Cylindrical
47J-4307R9RC02	IN2005	38.0	0.438	4	.020	2.75	0.75	.438" Cylindrical
47D-5010S4RC30	IN2005	38.0	0.500	4	Sharp	3.00	1.00	.500" Cylindrical
47D-501078RC30	IN2005	38.0	0.500	4	Sharp	3.00	1.00	.500" Weldon
47J-5010S4RC30	IN2005	38.0	0.500	4	.010	3.00	1.00	.500" Cylindrical
47J-5010S4RC02	IN2005	38.0	0.500	4	.020	3.00	1.00	.500" Cylindrical
47J-5010S4RC03	IN2005	38.0	0.500	4	.030	3.00	1.00	.500" Cylindrical
47J-5010S4RC06	IN2005	38.0	0.500	4	.060	3.00	1.00	.500" Cylindrical

POWERROUNDS™ SERIES 47J_RC, 47D_RC

PRECISION CENTER-CUTTING END MILLS, 4-FLUTE, 38 DEGREE HELIX



Shoulder



Slabbing



Channel



Ramping



Corkscrew



Pocket



Facing

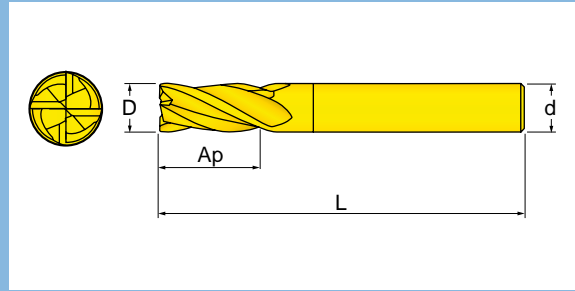

Grade
IN2005

P	M	K	N _(K)	S _(M)	H _(PK)
+	+	+		+	

	e8
	h6



+ Preferred choice ○ Second choice

Cutter Number	Grade	Helix (deg)	D Diameter	Z Flutes	C Corner	L Overall Length	Ap Cut Length	d Shank Size/Style
47D-6210S6RC35	IN2005	38.0	0.625	4	Sharp	3.50	1.00	.625" Cylindrical
47D-621079RC35	IN2005	38.0	0.625	4	Sharp	3.50	1.00	.625" Weldon
47J-6210S6RC00	IN2005	38.0	0.625	4	.010	3.50	1.00	.625" Cylindrical
47J-6210S6RC03	IN2005	38.0	0.625	4	.030	3.50	1.00	.625" Cylindrical
47J-6210S6RC06	IN2005	38.0	0.625	4	.060	3.50	1.00	.625" Cylindrical
47D-7510S7RC40	IN2005	38.0	0.750	4	Sharp	4.00	1.50	.750" Cylindrical
47D-751584RC40	IN2005	38.0	0.750	4	Sharp	4.00	1.50	.750" Weldon
47J-7515S7RC00	IN2005	38.0	0.750	4	.010	4.00	1.50	.750" Cylindrical
47J-7515S7RC02	IN2005	38.0	0.750	4	.020	4.00	1.50	.750" Cylindrical
47J-7515S7RC03	IN2005	38.0	0.750	4	.030	4.00	1.50	.750" Cylindrical
47J-7515S7RC06	IN2005	38.0	0.750	4	.060	4.00	1.50	.750" Cylindrical

Operating guidelines on [page 402](#).

PRECISION CENTER-CUTTING END MILLS, 3-FLUTE, 38 DEGREE HELIX

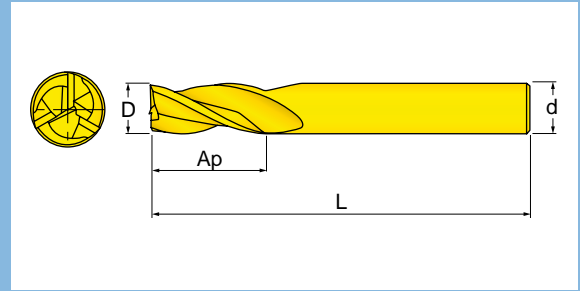

Grade	P	M	K	N _(K)	S _(M)	H _(PK)
IN2005	+	+	+		+	

	e8
	h6



+ Preferred choice ○ Second choice

Cutter Number	Grade	Helix (deg)	D Diameter	Z Flutes	C Corner	L Overall Length	Ap Cut Length	d Shank Size/Style
46J-1202R4RC15	IN2005	38.0	0.125	3	Sharp	1.50	0.25	.125" Cylindrical
46D-1202R4RC00	IN2005	38.0	0.125	3	.010	1.50	0.25	.125" Cylindrical
46J-1803R5RC20	IN2005	38.0	0.188	3	Sharp	2.00	0.38	.188" Cylindrical
46D-1803R5RC00	IN2005	38.0	0.188	3	.010	2.00	0.38	.188" Cylindrical
46J-2505R6RC25	IN2005	38.0	0.250	3	Sharp	2.50	0.50	.250" Cylindrical
46D-2505R6RC02	IN2005	38.0	0.250	3	.020	2.50	0.50	.250" Cylindrical
46J-3106R7RC25	IN2005	38.0	0.312	3	Sharp	2.50	0.63	.312" Cylindrical
46D-3106R7RC02	IN2005	38.0	0.312	3	.020	2.50	0.63	.312" Cylindrical
46J-3707R8RC25	IN2005	38.0	0.375	3	Sharp	2.50	0.75	.375" Cylindrical
46J-370777RC25	IN2005	38.0	0.375	3	Sharp	2.50	0.75	.375" Weldon
46D-3707R8RC02	IN2005	38.0	0.375	3	.020	2.50	0.75	.375" Cylindrical
46D-3710S4RC30	IN2005	38.0	0.500	3	Sharp	3.00	1.00	.500" Cylindrical
46D-501078RC30	IN2005	38.0	0.500	3	Sharp	3.00	1.00	.500" Weldon
46J-5010S4RC03	IN2005	38.0	0.500	3	.030	3.00	1.00	.500" Cylindrical
46J-6210R4RC35	IN2005	38.0	0.625	3	Sharp	3.50	1.00	.625" Cylindrical
46J-621079RC35	IN2005	38.0	0.625	3	Sharp	3.50	1.00	.625" Weldon
46D-6210R4RC03	IN2005	38.0	0.625	3	.030	3.50	1.00	.625" Cylindrical
46J-7512S7RC40	IN2005	38.0	0.750	3	Sharp	4.00	1.25	.750" Cylindrical
46J0751284RC40	IN2005	38.0	0.750	3	Sharp	4.00	1.25	.750" Weldon
46D-7512S7RC03	IN2005	38.0	0.750	3	.030	4.00	1.25	.750" Cylindrical
46JE1015S1RC15	IN2005	38.0	1.000	3	Sharp	4.00	1.50	1.000" Cylindrical
46JE1015S1RC40	IN2005	38.0	1.000	3	Sharp	4.00	1.50	1.000" Weldon
46DE1015S1RC03	IN2005	38.0	1.000	3	.030	4.00	1.50	1.000" Cylindrical

Operating guidelines on [page 402](#).

STEDI ROUNDS™ SERIES 47C_RQ

SOLID CARBIDE END MILLS FOR ROUGHING & FINISHING, VARIABLE PITCH



Shoulder



Slabbing



Channel



Ramping



Corkscrew



Pocket



Facing

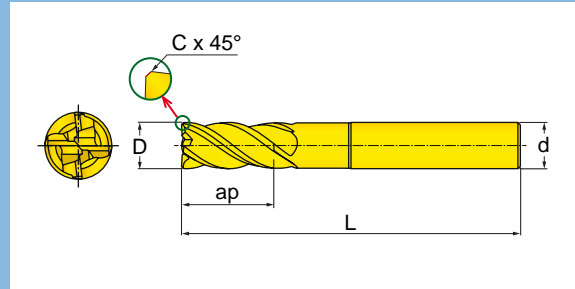

Grade	P	M	K	N _(K)	S _(M)	H _(PK)
IN2005	+	+	+		+	

	e8
	h6



+ Preferred choice ○ Second choice

Cutter Number	Grade	Helix (deg)	D Diameter	Z Flutes	C Chamfer	L Overall Length	Ap Cut Length	d Shank Size/Style
47C-1202R4RQ00	IN2005	38.0	0.125	4	.004x45	1.50	0.25	.125" Cylindrical
47C-1803R5RQ00	IN2005	38.0	0.188	4	.006x45	2.00	0.38	.188" Cylindrical
47C-2563R6RQ08	IN2005	38.0	0.250	5	.008x45	2.50	0.63	.250" Cylindrical
47C-2505R6RQ01	IN2005	38.0	0.250	4	.010x45	2.50	0.50	.250" Cylindrical
47C-3178R7RQ01	IN2005	38.0	0.312	5	.010x45	2.50	0.78	.312" Cylindrical
47C-3106R7RQ01	IN2005	38.0	0.312	4	.012x45	2.50	0.63	.312" Cylindrical
47C-3794R8RQ01	IN2005	38.0	0.375	5	.012x45	3.00	0.94	.375" Cylindrical
47C-379477RQ01	IN2005	38.0	0.375	5	.012x45	3.00	0.94	.375" Weldon
47C-3707R8RQ01	IN2005	38.0	0.375	4	.015x45	3.00	0.75	.375" Cylindrical
47C-370777RQ01	IN2005	38.0	0.375	4	.015x45	3.00	0.75	.375" Weldon
47C-5012S4RQ01	IN2005	38.0	0.500	5	.016x45	3.50	1.25	.500" Cylindrical
47C-501278RQ01	IN2005	38.0	0.500	5	.016x45	3.50	1.25	.500" Weldon
47C-5010S4RQ02	IN2005	38.0	0.500	4	.020x45	3.50	1.00	.500" Cylindrical
47C-501078RQ02	IN2005	38.0	0.500	4	.020x45	3.50	1.00	.500" Weldon
47C-6215S6RQ02	IN2005	38.0	0.625	5	.020x45	4.00	1.56	.625" Cylindrical
47C-621579RQ02	IN2005	38.0	0.625	5	.020x45	4.00	1.56	.625" Weldon
47C-6212S6RQ02	IN2005	38.0	0.625	4	.024x45	4.00	1.25	.625" Cylindrical
47C-621279RQ02	IN2005	38.0	0.625	4	.024x45	4.00	1.25	.625" Weldon
47C-7518S7RQ02	IN2005	38.0	0.750	5	.020x45	5.00	1.87	.750" Cylindrical
47C-751884RQ02	IN2005	38.0	0.750	5	.020x45	5.00	1.87	.750" Weldon
47C-7515S7RQ02	IN2005	38.0	0.750	4	.024x45	5.00	1.50	.750" Cylindrical
47C-751584RQ02	IN2005	38.0	0.750	4	.024x45	5.00	1.50	.750" Weldon
47C-1020S1RQ02	IN2005	38.0	1.000	4	.024x45	5.00	2.00	1.000" Cylindrical
47C-102080RQ02	IN2005	38.0	1.000	4	.024x45	5.00	2.00	1.000" Weldon

Operating guidelines on [page 402](#).

SOLID CARBIDE END MILLS FOR ALUMINIUM, 3-FLUTE, VARIABLE HELIX

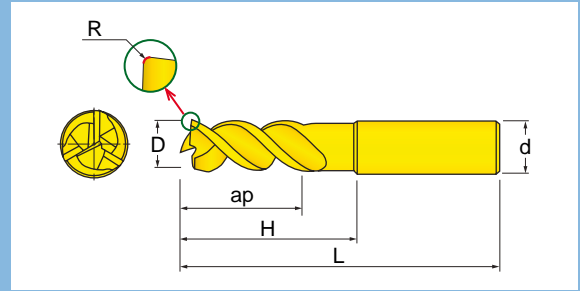

Grade	P	M	K	N _(K)	S _(M)	H _(PK)
IN05S				+		

	e8
	h6



+ Preferred choice ○ Second choice

Cutter Number	Grade	Helix (deg)	D Diameter	Z Flutes	R Radius	L Overall Length	H Height	Ap Cut Length	d Shank Size/Style
46D-2535R6RQ020	IN05S	39-41	0.250	3	0.020	2.50	0.750	0.35	.250" Cylindrical
46D-2535R6RQ030	IN05S	39-41	0.250	3	0.030	2.50	0.750	0.35	.250" Cylindrical
46D-2535R6RQ02	IN05S	39-41	0.250	3	0.020	2.50	1.250	0.35	.250" Cylindrical
46D-2535R6RQ03	IN05S	39-41	0.250	3	0.030	2.50	1.250	0.35	.250" Cylindrical
46D-3150R7RQ02	IN05S	39-41	0.312	3	0.020	2.50	0.900	0.50	.312" Cylindrical
46D-3150R7RQ03	IN05S	39-41	0.312	3	0.030	2.50	0.900	0.50	.312" Cylindrical
46D-3150R7RQ020	IN05S	39-41	0.312	3	0.020	2.50	1.560	0.50	.312" Cylindrical
46D-3150R7RQ030	IN05S	39-41	0.312	3	0.030	2.50	1.560	0.50	.312" Cylindrical
46D-3760R8RQ02	IN05S	39-41	0.375	3	0.020	2.50	1.125	0.60	.375" Cylindrical
46D-3760R8RQ03	IN05S	39-41	0.375	3	0.030	2.50	1.125	0.60	.375" Cylindrical
46D-3760R8RQ06	IN05S	39-41	0.375	3	0.060	2.50	1.125	0.60	.375" Cylindrical
46D-3760R8RQ020	IN05S	39-41	0.375	3	0.020	3.00	1.875	0.60	.375" Cylindrical
46D-3760R8RQ030	IN05S	39-41	0.375	3	0.030	3.00	1.875	0.60	.375" Cylindrical
46D-3760R8RQ060	IN05S	39-41	0.375	3	0.060	3.00	1.875	0.60	.375" Cylindrical
46D-5075S4RQ02	IN05S	39-41	0.500	3	0.020	3.00	1.500	0.75	.500" Cylindrical
46D-5075S4RQ03	IN05S	39-41	0.500	3	0.030	3.00	1.500	0.75	.500" Cylindrical
46D-5075S4RQ06	IN05S	39-41	0.500	3	0.060	3.00	1.500	0.75	.500" Cylindrical
46D-5075S4RQ020	IN05S	39-41	0.500	3	0.020	4.50	2.500	0.75	.500" Cylindrical
46D-5075S4RQ030	IN05S	39-41	0.500	3	0.030	4.50	2.500	0.75	.500" Cylindrical
46D-5075S4RQ060	IN05S	39-41	0.500	3	0.060	4.50	2.500	0.75	.500" Cylindrical
46D-6210S6RQ02	IN05S	39-41	0.625	3	0.020	3.50	1.870	1.00	.625" Cylindrical
46D-6210S6RQ03	IN05S	39-41	0.625	3	0.030	3.50	1.870	1.00	.625" Cylindrical
46D-6210S6RQ06	IN05S	39-41	0.625	3	0.060	3.50	1.870	1.00	.625" Cylindrical
46D-6210S6RQ09	IN05S	39-41	0.625	3	0.090	3.50	1.870	1.00	.625" Cylindrical
46D-6210S6RQ020	IN05S	39-41	0.625	3	0.020	5.00	3.125	1.00	.625" Cylindrical
46D-6210S6RQ030	IN05S	39-41	0.625	3	0.030	5.00	3.125	1.00	.625" Cylindrical
46D-6210S6RQ060	IN05S	39-41	0.625	3	0.060	5.00	3.125	1.00	.625" Cylindrical
46D-6210S6RQ090	IN05S	39-41	0.625	3	0.090	5.00	3.125	1.00	.625" Cylindrical
46D-7512S7RQ02	IN05S	39-41	0.750	3	0.020	5.00	2.250	1.20	.750" Cylindrical
46D-7512S7RQ03	IN05S	39-41	0.750	3	0.030	5.00	2.250	1.20	.750" Cylindrical
46D-7512S7RQ06	IN05S	39-41	0.750	3	0.060	5.00	2.250	1.20	.750" Cylindrical
46D-7512S7RQ09	IN05S	39-41	0.750	3	0.090	5.00	2.250	1.20	.750" Cylindrical
46D-7512S7RQ020	IN05S	39-41	0.750	3	0.020	6.00	3.750	1.20	.750" Cylindrical
46D-7512S7RQ030	IN05S	39-41	0.750	3	0.030	6.00	3.750	1.20	.750" Cylindrical
46D-7512S7RQ060	IN05S	39-41	0.750	3	0.060	6.00	3.750	1.20	.750" Cylindrical
46D-7512S7RQ090	IN05S	39-41	0.750	3	0.090	6.00	3.750	1.20	.750" Cylindrical

STEDI•ROUNDS™ SERIES 46D_RQ

SOLID CARBIDE END MILLS FOR ALUMINIUM, 3-FLUTE, VARIABLE HELIX



Shoulder



Slabbing



Channel



Ramping



Corkscrew



Pocket



Facing

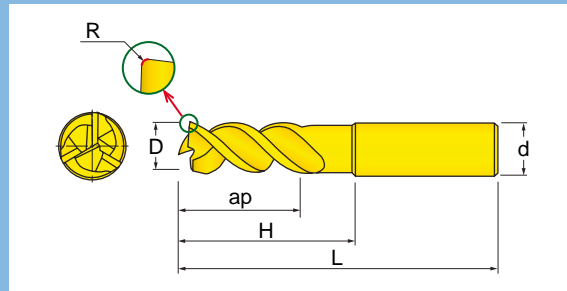

Grade
IN05S

P	M	K	N _(K)	S _(M)	H _(PK)
			+		

	e8
	h6



+ Preferred choice ○ Second choice

Cutter Number	Grade	Helix (deg)	D Diameter	Z Flutes	R Radius	L Overall Length	H Height	Ap Cut Length	d Shank Size/Style
46D-1015S1RQ02	IN05S	39-41	1.000	3	0.020	5.00	3.000	1.50	1.000" Cylindrical
46D-1015S1RQ03	IN05S	39-41	1.000	3	0.030	5.00	3.000	1.50	1.000" Cylindrical
46D-1015S1RQ06	IN05S	39-41	1.000	3	0.060	5.00	3.000	1.50	1.000" Cylindrical
46D-1015S1RQ09	IN05S	39-41	1.000	3	0.090	5.00	3.000	1.50	1.000" Cylindrical
46D-1015S1RQ12	IN05S	39-41	1.000	3	0.120	5.00	3.000	1.50	1.000" Cylindrical
46D-1015S1RQ020	IN05S	39-41	1.000	3	0.020	7.20	5.000	1.50	1.000" Cylindrical
46D-1015S1RQ030	IN05S	39-41	1.000	3	0.030	7.20	5.000	1.50	1.000" Cylindrical
46D-1015S1RQ060	IN05S	39-41	1.000	3	0.060	7.20	5.000	1.50	1.000" Cylindrical
46D-1015S1RQ090	IN05S	39-41	1.000	3	0.090	7.20	5.000	1.50	1.000" Cylindrical
46D-1015S1RQ120	IN05S	39-41	1.000	3	0.120	7.20	5.000	1.50	1.000" Cylindrical

Operating guidelines on [page 402](#).

SOLID CARBIDE END MILLS, COMBINATION ROUGHING/FINISHING

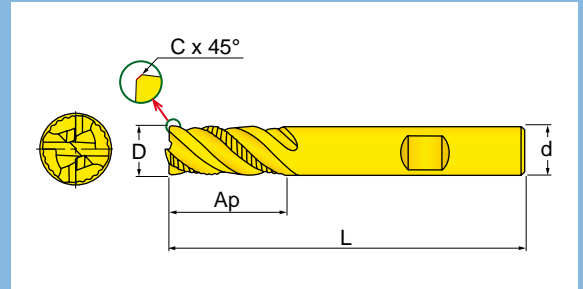

Grade
IN2005

P	M	K	N _(K)	S _(M)	H _(PK)
+	+	+		+	

	e9
	h6



+ Preferred choice ○ Second choice

Cutter Number	Grade	Helix (deg)	D Diameter	Z Flutes	C Chamfer	L Overall Length	Ap Cut Length	d Shank Size/Style
47C-2550R6RU01	IN2005	45	0.250	4	.010x45	2.50	0.50	.250" Cylindrical
47C-3162R7RU01	IN2005	45	0.312	4	.012x45	2.50	0.63	.312" Cylindrical
47C-3775R8RU01	IN2005	45	0.375	4	.012x45	3.00	0.75	.375" Cylindrical
47C-377577RU01	IN2005	45	0.375	4	.012x45	3.00	0.75	.375" Weldon
47C-5010S4RU01	IN2005	45	0.500	4	.016x45	3.00	1.00	.500" Cylindrical
47C-501078RU01	IN2005	45	0.500	4	.016x45	3.00	1.00	.500" Weldon
47C-6212S6RU02	IN2005	45	0.625	4	.024x45	3.50	1.00	.625" Cylindrical
47C-621279RU02	IN2005	45	0.625	4	.024x45	3.50	1.00	.625" Weldon
47C-7515S7RU02	IN2005	45	0.750	4	.024x45	4.00	1.25	.750" Cylindrical
47C-751584RU02	IN2005	45	0.750	4	.024x45	4.00	1.25	.750" Weldon
47C-1020S1RU02	IN2005	45	1.000	4	.024x45	5.00	1.50	1.000" Cylindrical
47C-102080RU02	IN2005	45	1.000	4	.024x45	5.00	1.50	1.000" Weldon

Operating guidelines on [page 402](#).

4 & 5 FLUTE HI FEED ROUGHING END MILL W/ VARIABLE PITCH & CHIP SPLITTERS



Shoulder



Slabbing



Channel



Ramping



Corkscrew



Pocket



Facing

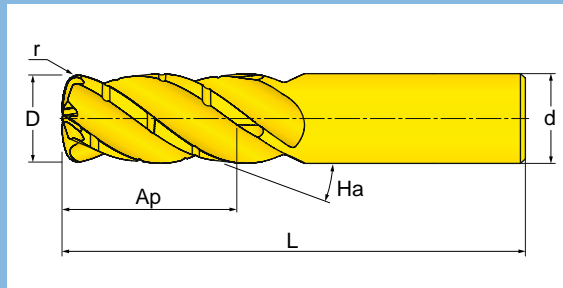

Grade	P	M	K	N _(K)	S _(M)	H _(PK)		e9
IN2005	+	+	○		+			h6

+ Preferred choice ○ Second choice



Cutter Number	Grade	Helix (deg)	D Diameter	Z Flutes	R Radius	L Overall Length	Ap Cut Length	d Shank Size/Style
45D-2550S3RP05	IN2005	38.0	0.250	4	0.050	2.50	0.500	.250" Cylindrical
45D-3162R7RP06	IN2005	38.0	0.312	4	0.060	2.50	0.625	.312" Cylindrical
45D-3775R8RP07	IN2005	38.0	0.375	4	0.070	3.00	0.750	.375" Cylindrical
45D-3793R8RP70	IN2005	38.0	0.375	5	0.070	3.00	0.938	.375" Cylindrical
45D-5010S4RP10	IN2005	38.0	0.500	4	0.100	3.00	1.000	.500" Cylindrical
45D-5012S4RP10	IN2005	38.0	0.500	4	0.100	3.00	1.250	.500" Cylindrical
45D-6212S6RP13	IN2005	38.0	0.625	4	0.130	3.50	1.200	.625" Cylindrical
45D-6215S6RP13	IN2005	38.0	0.625	5	0.130	3.00	1.560	.625" Cylindrical
45D-7515S7RP15	IN2005	38.0	0.750	4	0.150	4.00	1.500	.750" Cylindrical
45D-7518S7RP15	IN2005	38.0	0.750	5	0.150	4.00	1.870	.750" Cylindrical

Operating guidelines on [page 404](#).

BULL NOSE SOLID CARBIDE ENDMILLS, 2-FLUTES

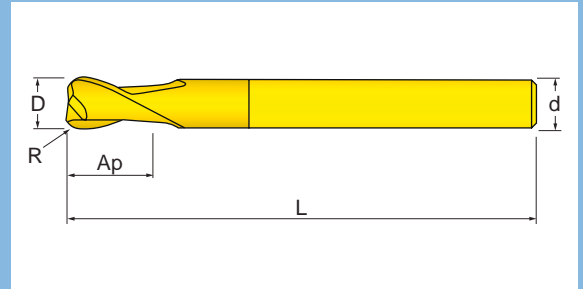

Grade
IN2005

P	M	K	N _(K)	S _(M)	H _(PK)
+	+	+		+	

	e8
	h6



+ Preferred choice ○ Second choice

Cutter Number	Grade	Helix (deg)	D Diameter	Z Flutes	R Radius	L Overall Length	Ap Cut Length	d Shank Size/Style
45U-0600R0RB01	IN2005	30.0	0.062	2	0.015	2.50	0.03	.062" Cylindrical
45U-0900R1RB03	IN2005	30.0	0.093	2	0.031	3.00	0.08	.093" Cylindrical
45U-1200R4RB03	IN2005	30.0	0.125	2	0.031	3.00	0.08	.125" Cylindrical
45U-2501R6RB06	IN2005	30.0	0.250	2	0.062	3.00	0.12	.250" Cylindrical
45U-2501R6RB061	IN2005	30.0	0.250	2	0.062	4.00	0.16	.250" Cylindrical
45U-3701R8RB06	IN2005	30.0	0.375	2	0.062	4.00	0.16	.375" Cylindrical
45U-3701R8RB061	IN2005	30.0	0.375	2	0.062	5.00	0.16	.375" Cylindrical
45U-5002S4RB12	IN2005	30.0	0.500	2	0.125	5.00	0.25	.500" Cylindrical
45U-5002S4RB121	IN2005	30.0	0.500	2	0.125	6.50	0.25	.500" Cylindrical

Operating guidelines on [page 402](#).

HI-FEED SOLID CARBIDE ENDMILLS, 4-FLUTES



Shoulder



Channel



Ramping



Corkscrew



Pocket



Facing



Contour

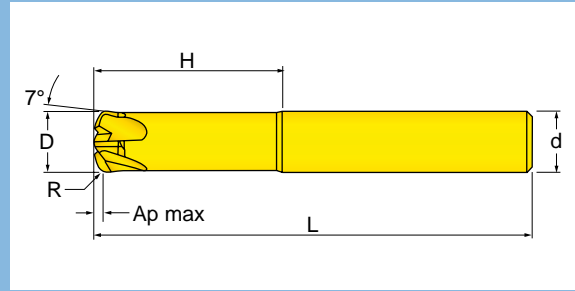

Grade	P	M	K	N _(K)	S _(M)	H _(PK)
IN2005	+	+	+		+	

+ Preferred choice ○ Second choice

	e8
	h6



Cutter Number	D Diameter	Z Flutes	C Radius	L Overall Length	H Height	Ap Cut Length	d Shank Size/Style	
45A-2500R6RA03	IN2005	0.250	4	0.040	2.48	0.780	0.12	.250" Cylindrical
45A-3100R7RA05	IN2005	0.312	4	0.050	2.48	1.030	0.13	.312" Cylindrical
45A-3700R8RA06	IN2005	0.375	4	0.060	2.98	1.230	0.15	.375" Cylindrical
45A-5000S4RA07	IN2005	0.500	4	0.080	2.98	1.320	0.18	.500" Cylindrical

Operating guidelines on [page 404](#).

PRO^oROUNDS™ SERIES 45B_RB, 46B_RB, 47B_RB

BALL NOSE SOLID CARBIDE END MILLS, MULTI-PURPOSE

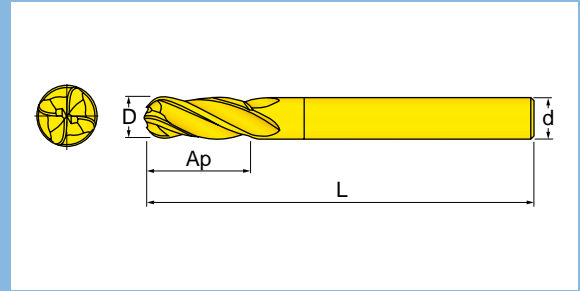

Grade	P	M	K	N _(K)	S _(M)	H _(PK)
IN2005	+	+	+		+	

	e8
	h6



+ Preferred choice ○ Second choice

Cutter Number	Grade	Length	Helix (deg)	D Diameter	Z Flutes	R Radius	L Overall Length	Ap Cut Length	d Shank Size/Style
45B-1201R4RB15	IN2005	Short	30.0	0.125	2	0.063	1.50	0.19	.125" Cylindrical
45B-1802R5RB20	IN2005	Short	30.0	0.188	2	0.094	2.00	0.25	.188" Cylindrical
45B-2503R6RB25	IN2005	Short	30.0	0.250	2	0.125	2.50	0.31	.250" Cylindrical
45B-3103R7RB25	IN2005	Short	30.0	0.312	2	0.157	2.50	0.38	.312" Cylindrical
45B-3704R8RB25	IN2005	Short	30.0	0.375	2	0.188	2.50	0.44	.375" Cylindrical
45B-4305R9RB27	IN2005	Short	30.0	0.438	2	0.219	2.75	0.50	.438" Cylindrical
45B-5005S4RB30	IN2005	Short	30.0	0.500	2	0.250	3.00	0.56	.500" Cylindrical
45B-6206S6RB35	IN2005	Short	30.0	0.625	2	0.313	3.50	0.69	.625" Cylindrical
46B-1201R4RB15	IN2005	Short	30.0	0.125	3	0.063	1.50	0.19	.125" Cylindrical
46B-1802R5RB20	IN2005	Short	30.0	0.188	3	0.094	2.00	0.25	.188" Cylindrical
46B-2503R6RB25	IN2005	Short	30.0	0.250	3	0.125	2.50	0.31	.250" Cylindrical
46B-3103R7RB25	IN2005	Short	30.0	0.312	3	0.157	2.50	0.38	.312" Cylindrical
46B-3704R8RB25	IN2005	Short	30.0	0.375	3	0.188	2.50	0.44	.375" Cylindrical
46B-5005S4RB30	IN2005	Short	30.0	0.500	3	0.250	3.00	0.56	.500" Cylindrical
46B-6206S6RB35	IN2005	Short	30.0	0.625	3	0.313	3.50	0.69	.625" Cylindrical
47B-1201R4RB15	IN2005	Short	30.0	0.125	4	0.063	1.50	0.02	.125" Cylindrical
47B-1205R4RB15	IN2005	Medium	30.0	0.125	4	0.063	1.50	0.69	.125" Cylindrical
47B-1202R4RB22	IN2005	Long	30.0	0.125	4	0.063	2.25	0.25	.125" Cylindrical
47B-1802R5RB20	IN2005	Short	30.0	0.188	4	0.094	2.00	0.25	.188" Cylindrical
47B-1806R5RB20	IN2005	Medium	30.0	0.188	4	0.094	2.00	0.50	.188" Cylindrical
47B-1803R5RB25	IN2005	Long	30.0	0.188	4	0.094	2.50	0.38	.188" Cylindrical
47B-2503R6RB25	IN2005	Short	30.0	0.250	4	0.125	2.50	0.31	.250" Cylindrical
47B-2507R6RB25	IN2005	Medium	30.0	0.250	4	0.125	2.50	0.63	.250" Cylindrical
47B-2505R6RB40	IN2005	Long	30.0	0.250	4	0.125	4.00	0.50	.250" Cylindrical
47B-3103R7RB25	IN2005	Short	30.0	0.312	4	0.157	2.50	0.38	.312" Cylindrical
47B-3108R7RB25	IN2005	Medium	30.0	0.312	4	0.157	2.50	0.75	.312" Cylindrical
47B-3107R7RB40	IN2005	Long	30.0	0.312	4	0.157	4.00	0.75	.312" Cylindrical
47B-3704R8RB25	IN2005	Short	30.0	0.375	4	0.188	2.50	0.44	.375" Cylindrical
47B-3710R8RB30	IN2005	Medium	30.0	0.375	4	0.188	3.00	0.81	.375" Cylindrical
47B-0308R8RB40	IN2005	Long	30.0	0.375	4	0.188	4.00	0.88	.375" Cylindrical
47B-4305R9RB27	IN2005	Short	30.0	0.438	4	0.219	2.75	0.50	.438" Cylindrical
47B-4310R9RB30	IN2005	Medium	30.0	0.438	4	0.219	3.00	1.00	.438" Cylindrical
47B-5005S4RB30	IN2005	Short	30.0	0.500	4	0.250	3.00	0.56	.500" Cylindrical
47B-5010S4RB30	IN2005	Medium	30.0	0.500	4	0.250	3.00	1.00	.500" Cylindrical
47B-5010S4RB45	IN2005	Long	30.0	0.500	4	0.250	4.50	1.00	.500" Cylindrical

PRO•ROUNDS™ SERIES 45B_RB, 46B_RB, 47B_RB

BALL NOSE SOLID CARBIDE END MILLS, MULTI-PURPOSE



Shoulder



Channel



Ramping



Corkscrew



Pocket



Contour

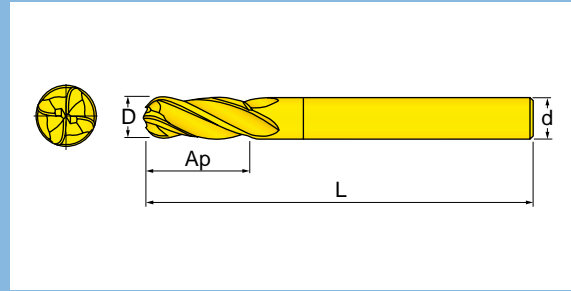

Grade

IN2005

P

+

M

+

K

+

N_(K)

S_(M)

+

H_(PK)

△

□

e8

h6

λ

≈ 30°

≤ 63 HRC



+ Preferred choice ○ Second choice

Cutter Number	Length	Helix (deg)	D Diameter	Z Flutes	R Radius	L Overall Length	Ap Cut Length	d Shank Size/Style	
47B-6206S6RB35	IN2005	Short	30.0	0.625	4	0.313	3.50	0.69	.625" Cylindrical
47B-6212S6RB35	IN2005	Medium	30.0	0.625	4	0.313	3.50	1.00	.625" Cylindrical
47B-6212S6RB50	IN2005	Long	30.0	0.625	4	0.313	5.00	1.25	.625" Cylindrical
47B-7515S7RB40	IN2005	Medium	30.0	0.750	4	0.375	4.00	1.25	.750" Cylindrical
47B-7515R8RB50	IN2005	Long	30.0	0.750	4	0.375	5.00	1.50	.750" Cylindrical

Operating guidelines on [page 402](#).

Ingersoll



- **DESIGNATION SYSTEM**
[PAGE 450](#)
- **GRADES**
[PAGE 452](#)
- **GENERAL MILLING FORMULA**
[PAGE 453](#)
- **ROUND LINE MARKING**
[PAGE 455](#)
- **SYMBOLS**
[PAGE 456](#)
- **APPLICATION EXAMPLES**
[PAGE 457](#)
- **REGRIND INFORMATION**
[PAGE 459](#)
- **INDEXING CHIP SURFER TIPS**
[PAGE 462](#)

TECHNICAL INFORMATION.

Cutting Tools

- **CHIP SURFER AND ROUND LINE BALL NOSE / END MILLS
OPERATING GUIDELINES**
[PAGE 464](#)
- **CHIP SURFER AND ROUND LINE HIGH FEED END MILL
(4 AND/OR 6 FLUTE) OPERATING GUIDELINES**
[PAGE 466](#)
- **CHIP SURFER HI FEED (2 FLUTE) END MILL
OPERATING GUIDELINES**
[PAGE 468](#)
- **CHIP SURFER CENTER DRILL OPERATING GUIDELINES**
[PAGE 469](#)
- **CHIP SURFER THREAD MILL OPERATING GUIDELINES**
[PAGE 470](#)
- **CHIP SURFER T-SLOTTER (18T) OPERATING GUIDELINES**
[PAGE 472](#)

DESIGNATION SYSTEM SOLID CARBIDE MILLING CUTTERS

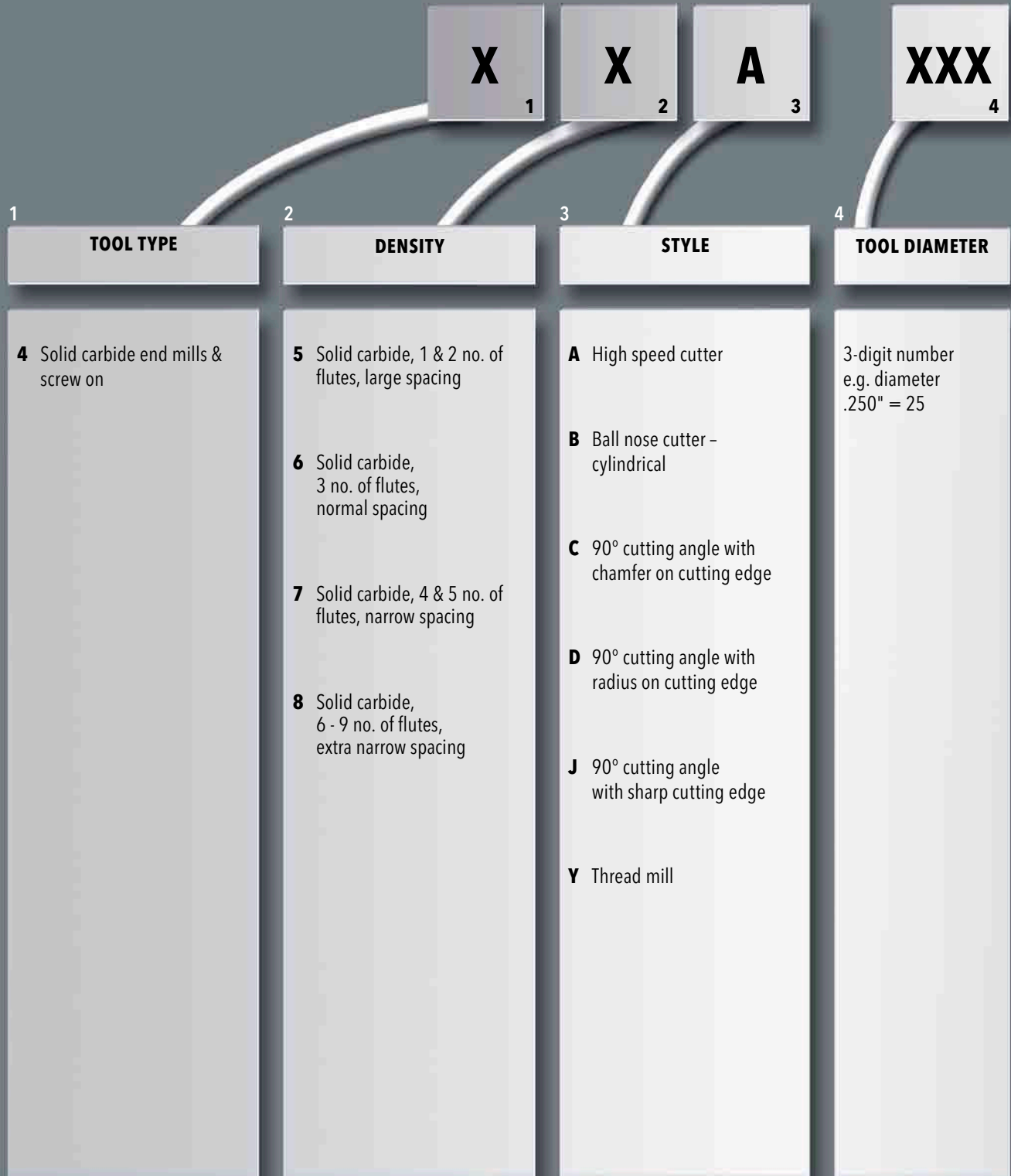

- A = Letter
- X = Number
- E = Number or letter
- H = Letter
- O = Standard or special design

* = Depending on tool type up to 4 digits can be used on this position when detailed designation is required.

<div style="border: 1px solid black; padding: 5px; text-align: center; font-weight: bold; font-size: 1.2em;">XX</div> <div style="text-align: center; font-weight: bold; font-size: 0.8em;">5</div> <div style="border: 1px solid black; padding: 5px; font-weight: bold; font-size: 0.8em;">CUTTING LENGTH OR TOOL HEIGHT</div>	<div style="border: 1px solid black; padding: 5px; text-align: center; font-weight: bold; font-size: 1.2em;">EE</div> <div style="text-align: center; font-weight: bold; font-size: 0.8em;">6</div> <div style="border: 1px solid black; padding: 5px; font-weight: bold; font-size: 0.8em;">ADAPTION CODE</div>	<div style="border: 1px solid black; padding: 5px; text-align: center; font-weight: bold; font-size: 1.2em;">H</div> <div style="text-align: center; font-weight: bold; font-size: 0.8em;">7</div> <div style="border: 1px solid black; padding: 5px; font-weight: bold; font-size: 0.8em;">ROTATING DIRECTION</div>	<div style="border: 1px solid black; padding: 5px; text-align: center; font-weight: bold; font-size: 1.2em;">00</div> <div style="text-align: center; font-weight: bold; font-size: 0.8em;">8</div> <div style="border: 1px solid black; padding: 5px; font-weight: bold; font-size: 0.8em;">STANDARD OR SPECIAL TOOLS</div>
<p>2-digit number e. g. cutting length .75" = 07 1.25" = 12</p>	<p>70 0.750 Weldon 71 0.312 Weldon 77 0.375 Weldon 78 .0500 Weldon 79 0.625 Weldon 80 1.000 Weldon 81 1.250 Weldon 82 2.000 Weldon 83 2.500 Weldon 84 0.750 Weldon 85 0.875 Weldon 86 1.500 Weldon R4 0.125 Straight Shank R5 0.187 Straight Shank R6 0.250 Straight Shank R7 0.312 Straight Shank R8 0.375 Straight Shank R9 0.437 Straight Shank S1 1.000 Straight Shank S2 2.000 Straight Shank S3 2.500 Straight Shank S4 0.500 Straight Shank S5 1.500 Straight Shank S6 0.625 Straight Shank S7 0.750 Straight Shank S8 0.875 Straight Shank S9 1.250 Straight Shank TQ T05 Chip Sufer T6 T06 Chip Sufer T8 T08 Chip Sufer TR T10 Chip Sufer TS T12 Chip Sufer TU T15 Chip Sufer</p>	<p>R R.H. mills L L.H. mills - neutral (R.H./L.H.)</p>	<p>A 0°-25° pos. helical angle B 26°-34° pos. helical angle C 35°-44° pos. helical angle D pos. helical angle > 45° N > 45° pos. helical angle with chip breaker resp. neutral slot mill Q HPC divers spacing U 45° roughing and finishing</p>

Subject to technical changes

CHIP SURFER & ROUND LINE

GRADES

UNCOATED CARBIDES

IN05S	M10-M20	Micro-grain carbide grade, well suitable for machining titanium and super alloys of the ISO material group S. Also applied successfully for non-ferrous metals as well as for light-duty milling in gray cast iron.
--------------	----------------	---

COATED CARBIDES

IN2005	P15-P30	Coated micro-grain carbide grade with good toughness and excellent wear resistance for machining steels with increased tenacity, stainless steels, titanium as well as gray cast iron and nodular cast iron.
	M15-M35	
	K20-K40	
IN2006	P05-P20	Coated micro-grain carbide grade with good toughness and excellent wear resistance for machining hardened steels up to 62 HRC.
	M10-M20	
IN1030	P20-P40	Universal grade for all steels. Wet milling of stainless steel at medium cutting speed. Very tough and resistant to chipping.
	M20-M40	
	K15-K30	
IN3005		Diamond coated for milling graphite.

PCD

IN90D	K01-K10	Polycrystalline diamond (PCD) for machining aluminum, plastics and graphite.
--------------	----------------	--

PCD

IN80B	K01-K20	Cubic Boron Nitride (CBN) for machining iron and hard steel.
--------------	----------------	--

CHIP SURFER & ROUND LINE

GENERAL FORMULA FOR MILLING OPERATIONS

Value	Unit	Formula
RPM	min ⁻¹	$n = \frac{v_c \times 1000}{D \cdot \pi}$
Cutting speed	ft/min	$v_c = \frac{D \cdot \pi \cdot n}{1000}$
Feed rate	inch/min	$v_f = f_z \cdot Z_{\text{eff}} \cdot n$
Feed per tooth	inch	$f_z = \frac{v_f}{Z_{\text{eff}} \cdot n}$
Chip removal rate	cm ³ /min	$Q = \frac{a_e \cdot a_p \cdot v_f}{1000}$
Average chip thickness	mm	$h_m = f_z \cdot \sqrt{a_e/D}$

Calculation example shoulder milling



Workpiece material:	4340
Cutter type:	HPC
Cutter designation:	47D-3707R8RC02
Cutter diameter:	.375
Effective no. of teeth:	4
Cutting depth a_p :	.125
Cutting width a_e :	.10
Cutting speed v_c :	450 SFM
Feed per tooth f_z :	.004
Calculation of no. of revolutions:	$n = \frac{450 \cdot 12}{.375 \cdot \pi} = 4584 \text{ min}^{-1}$
Calculation of feed rate:	$v_f = .004 \cdot 4 \cdot 4584 = 73.3 \text{ ipm}$
Calculation of chip removal rate:	$Q = 4584 \times .125 \times .10 \times .004 \times 4 = .91 \text{ in}^3/\text{min}$
Calculation of average chip thickness:	$h_m = .004 \cdot \sqrt{.10/.375} = .002 \text{ in}$

CHIP SURFER & ROUND LINE

GENERAL FORMULA FOR MILLING OPERATIONS

Explanation of catalog parameters and formula symbols

Symbol	Unit	Designation
D	inch	Nominal diameter
n	min ⁻¹	RPM
a_e	inch	Width of cut
a_p	inch	Cutting depth
f_z	inch	Feed per tooth
f	mm/U	Feed per revolution
h_m	inch	Average chip thickness
P_c	kW	Spindle power consumption
Q	ft ³ /min	Chip removal rate
v_c	ft/min	Cutting speed
v_f	in/min	Feed rate
C	x 45°	Chamfer
R	-	Radius

MARKING OF SOLID CARBIDE MILLING CUTTERS

Example

EXAMPLE 1

Designation	47C-370777RQ01
Marking	D.375 L.75 R.015 C.375
D	Diameter
0.375	Nominal cutter diameter in inches
Ap	Cutting length
0.750	Nominal cutting length in inches
C	Chamfer
0.015	Nominal size of chamfer in inches
W	Weldon-shank
0.375	Nominal diameter of shank in inches

EXAMPLE 2

Designation	47J-5010S4RC06
Marking	D.500 L1.00 R.060 C.500
D	Diameter
0.500	Nominal cutter diameter in inches
Ap	Cutting length
1.000	Nominal cutting length in inches
R	Radius
0.060	Nominal corner radius in inches
C	Weldon-shank
0.500	Nominal diameter of shank in inches

CHIP SURFER & ROUND LINE

SYMBOLS



Helix angle



Milling of hard materials up to HRC (Rockwell hardness)



Qualified for wet machining



Dry machining



Non-ferrous machining

CHIP SURFER & ROUND LINE

APPLICATION EXAMPLE

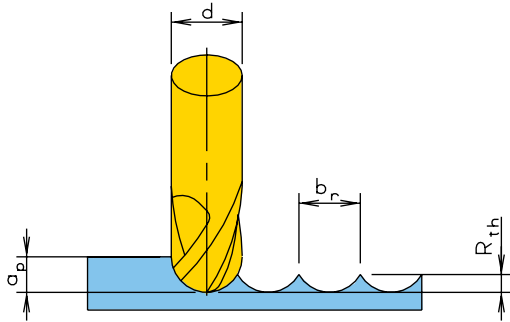

Influence of cutting line width on surface roughness

Calculation of cutting line width: $b_r = 2 \times \sqrt{a_p \times (d - a_p)}$

Kinematic roughness: $R_{th} = \frac{d}{2} - \sqrt{\frac{d^2 - b_r^2}{4}}$

MILLING OF HARD MATERIALS

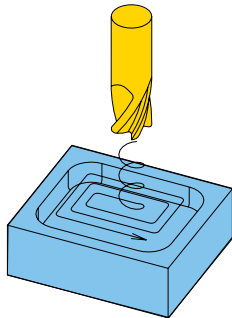

Roughing 3D

- Center plunging with circular interpolation
- Climb milling $a_e \leq$ cutter radius
- Edge honing
- Small widths of cut
- Constant feed rates

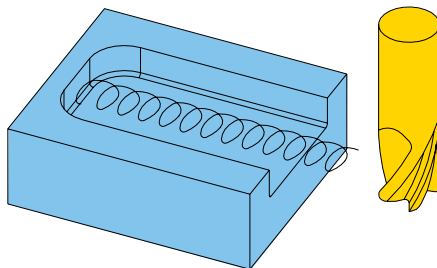

Milling of full slots in hardened steel ≥ 54 HRC

- Spiral-type machining (trochoidal milling)
- Constant feed
- Constant cutting conditions
- Good chip flow (air)

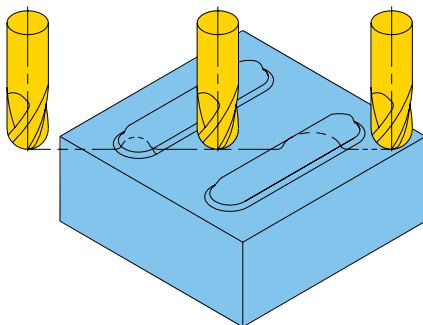





Finishing 3D

- Avoid complete arc of contact of cutter
- Diagonal machining
- Hone edges, if radius of geometry is \leq than cutter radius
- Pay attention to bevel angle of ball nose cutters (15° - 20°) to avoid $v_c \leq 0$

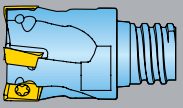
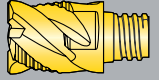
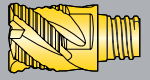
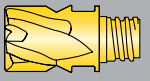
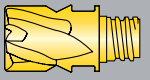
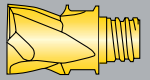
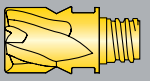
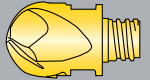
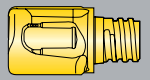
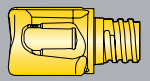
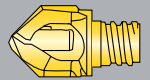
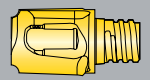
CHIP SURFER

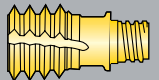
CHIP SURFER™ MODULAR MILLING SYSTEM FOR NC SWISS AND LIVE TOOLING APPLICATIONS

- Hi-PosMicro Indexable 
- Rough-Fin 
- Serrated Roughing 
- 0° Lead 45° Helix Center Cutting 
- Variable Pitch 0° Lead 38° Helix Center Cutting 
- Polished for Aluminum 
- Finishing 0° Lead, 45° Helix Non-Center Cutting 
- High Precision Helical Ball Nose 
- Flat Bottom Plunger 
- Drill-Mill 
- Chamfer & Spotting 
- Corner Rounding 
- Precision T-Slot 
- Thread Mill 
- Center Drill 

CONNECTION CHART	
END MILL SIZE	CONNECTION SIZE
.250/.312	T05
.375	T06
.500	T08
.625	T10
.750	T12
1.00	T15

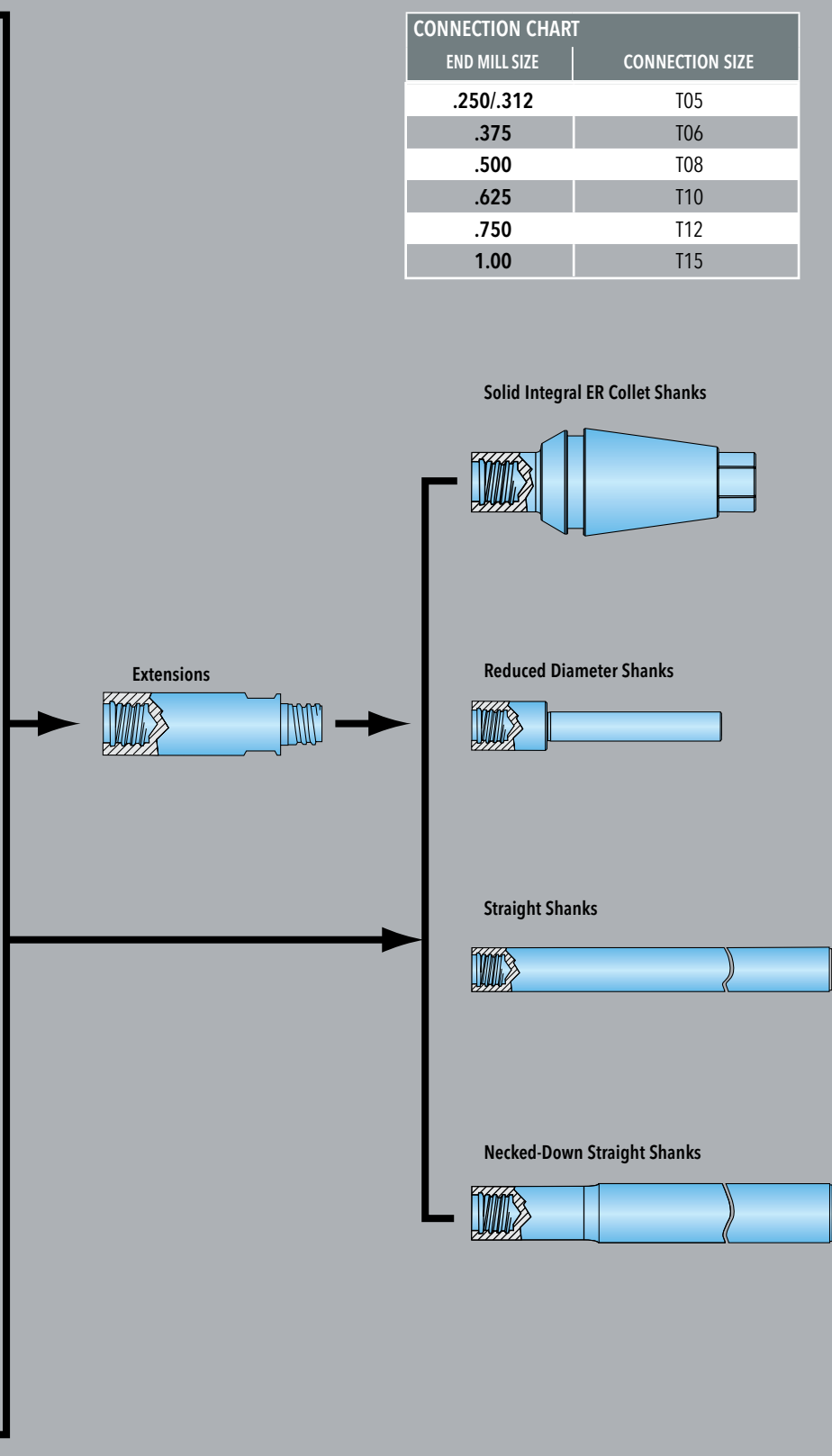

GENERAL TECHNICAL INFORMATION

DATA FOR REGRINDING SOLID CARBIDE MILLS

	d1	a	RA	Pra/Rra	SRa	tA	aA	PA	SA	W	A	A1	Lw	Aw	P	B
End mill																
2 flutes	<.300"	30	12	13	-	2.5	5	10	17	.007xd1	11.5	-	-	.004xd1	-	-
	<.300"	30	10	12	-	2	5	10	17	.007xd1	11.0	-	-	.004xd1	-	-
3 flutes	<.300"	38-45	12	13	-	2	6	8	16	.007xd1	10.5	-	-	.004xd1	-	-
	<.300"	38-45	10	12	-	1.5	6	7	16	.006xd1	9.5	-	-	.004xd1	-	-
4 flutes	<.300"	30-45	11	13.5	-	1.5	5	8	16	.0065xd1	10.8	-	-	.004xd1	-	-
	<.300"	30-45	10	12	-	1.5	5	7	16	.006xd1	9.5	-	-	.004xd1	-	-
6 flutes	<.300"	45	10	11	-	1.5	5	7	16	.0055xd1	9.0	-	-	.003xd1	-	-
	<.300"	45	10	10	-	1.5	5	7	16	.005xd1	8.5	-	-	.003xd1	-	-
Ball nose mill																
2 flutes	<.300"	30	12	11	22	-	7	11	22	.007xd1	11.0	22	.0023xd1	.004xd1	(.017xd1)/2	.0060xd1
	<.300"	30	11	11	22	-	6	11	22	.0065xd1	11.0	22	.002xd1	.004xd1	(.017xd1)/2	.0058xd1
3 flutes	<.300"	30	12	11	22	-	7	11	22	.007xd1	11.0	22	.0023xd1	.004xd1	(.017xd1)/2	.0060xd1
	<.300"	30	11	11	22	-	6	11	22	.0065xd1	11.0	22	.002xd1	.004xd1	(.017xd1)/2	.0058xd1
4 flutes	<.300"	30	12	11	23	-	7	11	23	.007xd1	11.0	23	.0023xd1	.004xd1	(.017xd1)/2	.0060xd1
	<.300"	30	11	11	22	-	6	11	22	.0065xd1	11.0	22	.002xd1	.004xd1	(.017xd1)/2	.0058xd1
End mill with corner radius																
3 flutes	<.300"	38-45	12	13.5	25	3	8	8	17	.007xd1	10.8	21	.0023xd1	.004xd1	(.017xd1)/2	.0060xd1
	<.300"	38-45	10	12	25	3	8	8	17	.0065xd1	10.0	21	.002xd1	.004xd1	(.017xd1)/2	.0058xd1
4 flutes	<.300"	30-45	11	13.5	25	3	8	8	17	.007xd1	10.8	21	.0023xd1	.004xd1	(.017xd1)/2	.0060xd1
	<.300"	30-45	10	12	25	3	8	8	17	.0065xd1	10.0	21	.002xd1	.004xd1	(.017xd1)/2	.0058xd1
6 flutes	<.300"	45	10	11	16	2	8	7	16	.0055xd1	9.0	16	.0023xd1	.004xd1	(.017xd1)/2	.0050xd1
	<.300"	45	10	10	18	1.5	7	7	16	.005xd1	8.5	17	.002xd1	.004xd1	(.017xd1)/2	.0046xd1
Rough mill																
	<.300"	45	12	10	-	2.5	7	7	17	.008xd1	9.0	-	-	.008xd1	-	-
	<.300"	45	11	9	-	2.5	5	7	17	.008xd1	8.0	-	-	.006xd1	-	-
Aluminum mill																
2 flutes	<.300"	45-55	18	14	27	4	11	12	25	.0065xd1	13.0	26	.0023xd1	.004xd1	(.017xd1)/2	.0060xd1
	<.300"	45-55	17	13	26	4	11	11	24	.0075xd1	12.0	25	.002xd1	.004xd1	(.017xd1)/2	.0067xd1

Parameters / Paramètres:

d1	=	Cutter diameter	PA	=	Axial primary relief angle
a	=	Helix angle	SA	=	Axial secondary clearance angle
Ra	=	Radial rake angle	aA	=	Axial rake angle
PRa	=	Radial primary relief angle	Aw	=	Axial land width
SRa	=	Radial secondary clearance angle	A	=	Radius / chamfer primary relief angle
W	=	Radial flute width	A1	=	Radius / chamfer 2nd clearance angle
Lw	=	Radial land width	P	=	Radius / Chamfer land
tA	=	Dish angle	B	=	Radius / chamfer flute land

Regrinding and surface coating of end mills

1. Regrinding may not influence the original composition of surface substrate.
2. End mills have to be cleansed after regrinding, to remove oil or other dirt. Areas that have to be coated should be cleaned once more shortly before.
3. Thickness of coating to be 2 - 4 µm for TiCN- and TiAlN-alloys.

GENERAL TECHNICAL INFORMATION

CHIP GULLET AND FRONT FLUTE DESIGN

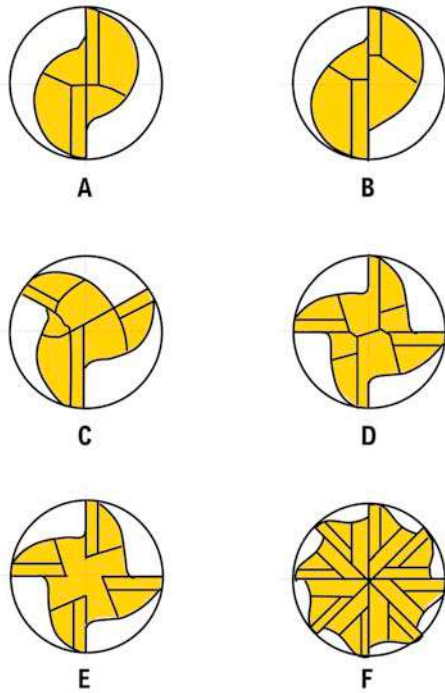

The number of flutes depends on:

- workpiece material.
- size of workpiece.
- milling conditions and profile shape.

Cutters with higher number of flutes have to be preferred, as long as chip flow is guaranteed.

Geometry of front flutes

- A = 2 flutes, 2 flutes cutting to center.
- B = 2 flutes, 1 flute cutting above center.
- C = 3 flutes, 1 flute cutting above center.
- D = 4 flutes, 2 flutes cutting to center.
- E = 2 or 4 flutes, **not** cutting above center.
- F = 5 or 6 flutes, **not** cutting above center.

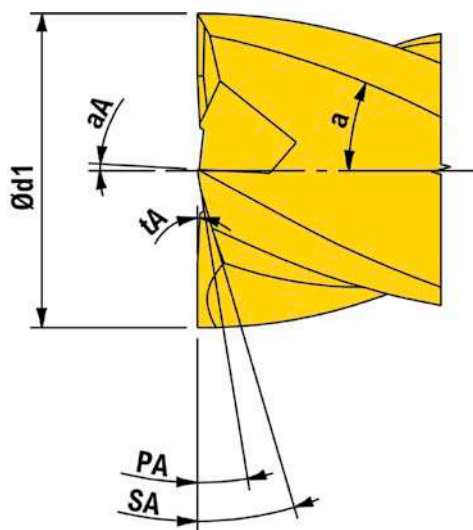

Geometry of front edges

- PA = Axial primary relief angle
- SA = Axial secondary clearance angle
- Ra = Radial rake angle
- aA = Axial rake angle
- tA = Dish angle
- d1 = Cutter diameter
- a = Helix angle

GENERAL TECHNICAL INFORMATION

RELIEF GRIND AND TOOL FLANK DESIGN

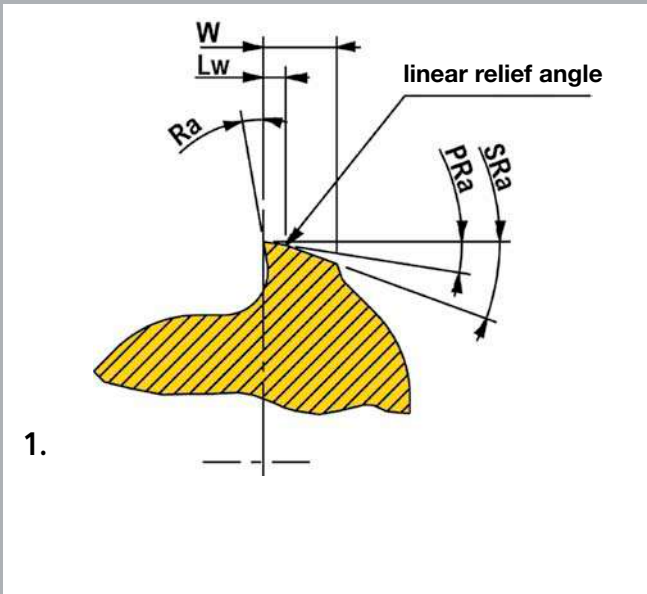

2 types of relief grinding:

1. 2-chamfered **linear relief grinding** with primary and secondary flute.
2. **Radial relief grinding**
The 2-chamfered surface relief grinding is the most common and easy to measure or to determine by the size of the relief angle.

The radial relief angle can be clearly indicated only over a determined measuring length, but the convex shape that reduces the angle, has to be taken into account also. This kind of grinding can offer considerable advantages, for example if regrinding shall only be carried out on the rake face.

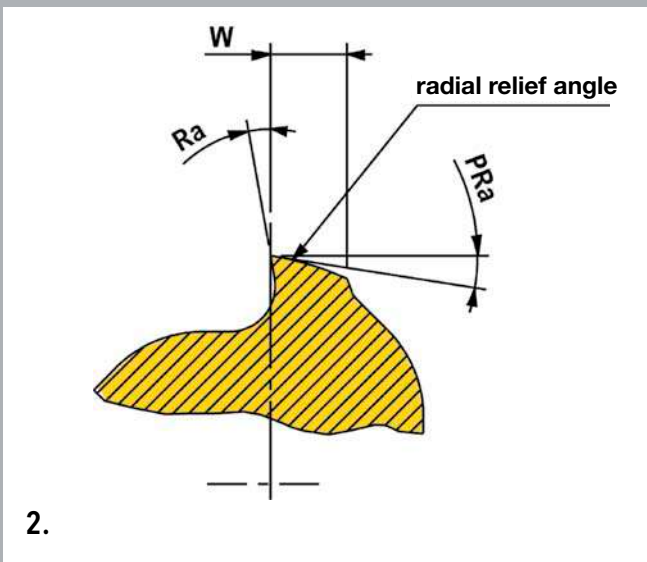

Milling performance and tool life of the cutter are very much influenced by the primary relief angle of the flutes. The primary relief angle depends on the application of the cutter (workpiece material etc.) as well as the suitable feed rate of the respective diameter. This is important especially for regrinding, because the performance of standard tools can thus be optimized.

- W** = Radial flute width
- LW** = Radial land width
- PRa** = Radial primary relief angle
- SRa** = Radial secondary relief angle
- Ra** = Radial rake angle

GENERAL TECHNICAL INFORMATION

INDEXING **CHIP SURFER**™ TIP GUIDELINES

- Step 1: Screw tip into shank until finger tight (Figure 1a). Note a .010" gap (Figure 1b).
- Step 2: Use wrench to torque approximately 1/4 turn, creating a simultaneous fit (Figure 2).
- Step 3: Use .001" shim stock to check the simultaneous fit at the intersection of the tip and the shank. The shim should not be able to enter the intersection (Figure 3a). If it does, tighten further with the wrench until there is no gap (Figure 3b).

Note: Pre-set torque wrenches (series DT- . . .) can be purchased.

Figure 1a. Finger tight



Figure 1b. .010" gap



Figure 2. 1/4 turn



Figure 3a. Shim should NOT enter intersection



Figure 3b. Proper fit



Series DT- . . . Optional Torque Wrench



Accuracy

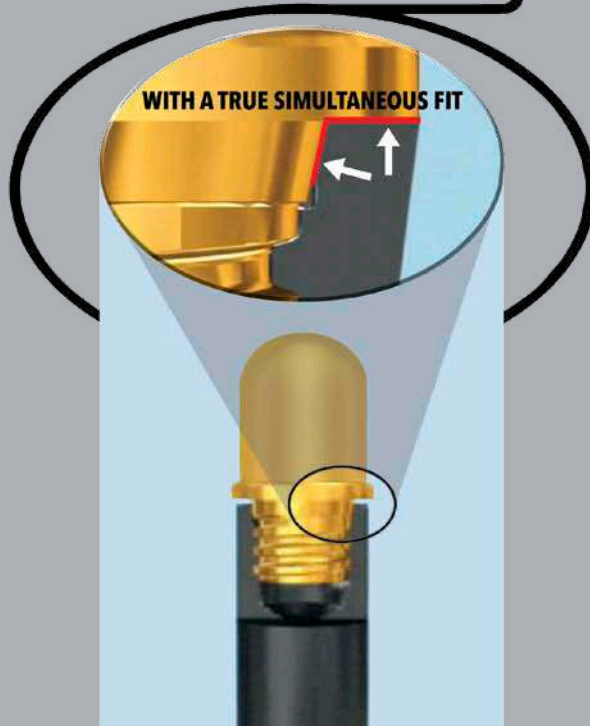

To view some of these products
in action, please visit us at:



OPERATING GUIDELINES

CHIP SURFER, ROUND LINE - STANDARD BALL NOSE AND END MILLS

Series 45B, 45D, 45J, 45M, 45N, 45P, 45X, 46D, 47C, 47D, 47J, 47N, 48C, 48D, 48J, 48N, 48U, 49D, 49J

Workpiece Material	Cutting speed vc in/min					Feed rate per tooth fz ft/min			
	DC in	Ball nose mill		End mill		Ball nose mill		End mill	
		Roughing copy milling	Finishing copy milling	Full slot	Shoulder	Roughing copy milling	Finishing copy milling	Full slot	Shoulder
Unalloyed steel P	.125-.250	525-725	725-975	300-600	450-800	.0015 - .0030	.0007 - .0020	.0006 - .0010	.0018 - .0030
	.312-.500	450-650	725-975	300-600	450-800	.0060 - .0080	.0040 - .0060	.0025 - .0040	.0040 - .0055
	.625-1.00	450-650	725-975	300-600	450-800	.0080 - .0100	.0060 - .0080	.0030 - .0040	.0060 - .0090
High Carbon steel < 1100N/mm ² P	.125-.250	400-600	325-600	250-500	325-725	.0013 - .0030	.0007 - .0020	.0006 - .0018	.0007 - .0025
	.312-.500	400-600	600-850	300-600	400-650	.0040 - .0070	.0030 - .0040	.0020 - .0030	.0030 - .0040
	.625-1.00	400-600	600-850	300-600	400-650	.0065 - .0090	.0040 - .0080	.0025 - .0040	.0040 - .0080
Alloyed / Tool steel < 1400N/mm ² P	.125-.250	325-525	500-800	250-450	325-525	.0018 - .0030	.0007 - .0020	.0006 - .0018	.0007 - .0020
	.312-.500	325-525	500-800	250-450	325-600	.0030 - .0055	.0028 - .0040	.0015 - .0028	.0028 - .0040
	.625-1.00	325-525	500-800	250-450	325-600	.0055 - .0080	.0040 - .0070	.0020 - .0030	.0040 - .0070
Stainless steel M	.125-.250	250-450	300-600	165-300	250-450	.0007 - .0015	.0007 - .0015	.0040 - .0007	.0040 - .0013
	.312-.500	250-450	300-600	165-300	250-450	.0030 - .0040	.0030 - .0040	.0015 - .0025	.0028 - .0040
	.625-1.00	250-450	300-600	165-300	250-450	.0040 - .0080	.0040 - .0080	.0025 - .0040	.0040 - .0080
Gray cast iron K	.125-.250	500-750	700-950	325-525	500-975	.0015 - .0030	.0007 - .0020	.0006 - .0010	.0018 - .0030
	.312-.500	500-750	700-950	325-525	500-900	.0060 - .0080	.0040 - .0060	.0025 - .0040	.0040 - .0055
	.625-1.00	500-750	700-950	250-550	500-900	.0080 - .0100	.0060 - .0080	.0030 - .0040	.0060 - .0090
Cast alloys K	.125-.250	400-650	600-850	250-550	400-650	.0013 - .0030	.0007 - .0020	.0006 - .0018	.0007 - .0025
	.312-.500	400-650	600-850	250-550	400-650	.0040 - .0070	.0030 - .0040	.0020 - .0030	.0030 - .0040
	.625-1.00	400-650	600-850	250-550	400-650	.0065 - .0090	.0040 - .0080	.0025 - .0040	.0040 - .0080
Aluminum N	.125-.250	825-2500	825-2500	825-2500	825-2500	.0015 - .0030	.0010 - .0025	.0007 - .0015	.0010 - .0030
	.312-.500	2500-3500	3000-5000	2500-3500	3000-5000	.0040 - .0070	.0040 - .0070	.0035 - .0040	.0040 - .0070
	.625-1.00	2500-3500	3000-5000	2500-3500	5000-6500	.0080 - .0100	.0060 - .0090	.0060 - .0070	.0070 - .0090
Plastics N	.125-.250	500-975	650-1300	400-650	650-1300	.0007 - .0015	.0007 - .0015	.0040 - .0018	.0070 - .0015
	.312-.500	500-975	650-1300	400-650	650-1300	.0030 - .0040	.0030 - .0040	.0020 - .0030	.0028 - .0040
	.625-1.00	500-975	650-1300	400-650	650-1300	.0040 - .0080	.0040 - .0080	.0028 - .0040	.0040 - .0080
Super alloys S	.125-.250	65-165	100-225	65-165	100-200	.0006 - .0010	.0007 - .0015	.0040 - .0006	.0040 - .0010
	.312-.500	65-165	100-225	65-165	100-200	.0020 - .0030	.0030 - .0040	.0010 - .0020	.0020 - .0040
	.625-1.00	65-165	100-225	65-165	100-200	.0030 - .0060	.0040 - .0080	.0020 - .0030	.0040 - .0070
Hardened steel 48 - 54 HRC	.125-.250	130-225	250-650	130-325	200-400	.0018 - .0030	.0007 - .0020	.0006 - .0018	.0007 - .0020
	.312-.500	130-225	250-650	130-325	200-400	.0030 - .0055	.0028 - .0040	.0015 - .0028	.0028 - .0040
	.625-1.00	130-225	250-650	130-325	200-400	.0055 - .0080	.0040 - .0070	.0020 - .0030	.0040 - .0070
Hardened steel 54 - 63 HRC	.125-.250	100-165	250-650	65-165	150-250	.0007 - .0025	.0007 - .0015	.0040 - .0007	.0040 - .0015
	.312-.500	100-165	250-650	65-200	150-250	.0025 - .0040	.0025 - .0030	.0010 - .0020	.0020 - .0030
	.625-1.00	100-165	250-650	65-200	150-250	.0040 - .0070	.0030 - .0040	.0015 - .0028	.0030 - .0060
Hardened steel > 63 HRC	.125-.250	65-165	100-350	65-100	100-200	.0006 - .0015	.0007 - .0010	.0040 - .0040	.0040 - .0010
	.312-.500	65-165	100-350	65-130	100-200	.0015 - .0040	.0015 - .0028	.0007 - .0015	.0015 - .0025
	.625-1.00	65-165	100-350	65-130	100-200	.0040 - .0060	.0028 - .0040	.0010 - .0025	.0025 - .0060

General Information:

Machining of aluminum and duroplastics with grade IN05S, any other materials with IN2005 / IN2006. Max. cutting depth of end mills is determined by cutting length a = xxx in; for ball nose cutters max. cutting depth is determined by radius.

Please consider the limitation of max. RPM of the machine! Cutting values refer to $n_{max} = 40000 \text{ min}^{-1}$

OPERATING GUIDELINES

CHIP SURFER[®], ROUND LINE - STANDARD BALL NOSE AND END MILLS

Workpiece Material	DC in	Cutting depth ap recomm. for		Cutting width Recommended ae %			
		Ball nose mill in	End mill in				
Unalloyed steel P	.125-.250	.004 x D	.0500 x D	40%			
	.312-.500	.004 x D	.0500 x D	40%			
	.625-1.00	.004 x D	.0500 x D	40%			
High Carbon steel < 1100N/mm ² P	.125-.250	.003 x D	.030 x D	30%			
	.312-.500	.003 x D	.030 x D	30%			
	.625-1.00	.003 x D	.030 x D	30%			
Alloyed / Tool steel < 1400N/mm ² P	.125-.250	.0025 x D	.030 x D	25%			
	.312-.500	.0025 x D	.030 x D	25%			
	.625-1.00	.0025 x D	.030 x D	25%			
Stainless steel M	.125-.250	.003 x D	.030 x D	30%			
	.312-.500	.003 x D	.030 x D	30%			
	.625-1.00	.003 x D	.030 x D	30%			
Gray cast iron K	.125-.250	.003 x D	.030 x D	40%			
	.312-.500	.003 x D	.030 x D	40%			
	.625-1.00	.003 x D	.030 x D	40%			
Cast alloys K	.125-.250	.003 x D	.030 x D	30%			
	.312-.500	.003 x D	.030 x D	30%			
	.625-1.00	.003 x D	.030 x D	30%			
Aluminum N	.125-.250	.040 x D	.040 x D	30%			
	.312-.500	.040 x D	.040 x D	30%			
	.625-1.00	.040 x D	.040 x D	30%			
Plastics N	.125-.250	.0040 x D	.040 x D	10%			
	.312-.500	.0040 x D	.040 x D	10%			
	.625-1.00	.0040 x D	.040 x D	10%			
Super alloys S	.125-.250	.0040 x D	.020 x D	10%			
	.312-.500	.0040 x D	.020 x D	10%			
	.625-1.00	.0040 x D	.020 x D	10%			
Hardened steel 48 - 54 HRC	.125-.250	.0025 x D	.030 x D	25%			
	.312-.500	.0025 x D	.030 x D	25%			
	.625-1.00	.0025 x D	.030 x D	25%			
Hardened steel 54 - 63 HRC	.125-.250	.002 x D	.027 x D	20%			
	.312-.500	.002 x D	.027 x D	20%			
	.625-1.00	.002 x D	.027 x D	20%			
Hardened steel > 63 HRC	.125-.250	.002 x D	.024 x D	10%			
	.312-.500	.002 x D	.024 x D	10%			
	.625-1.00	.002 x D	.024 x D	10%			

General Information:

Machining of aluminum and duroplastics with grade IN05S, any other materials with IN2005 / IN2006. Max. cutting depth of end mills is determined by cutting length a = xxx in; for ball nose cutters max. cutting depth is determined by radius. Please consider the limitation of max. RPM1 of the machine!

OPERATING GUIDELINES

CHIP SURFER, ROUND LINE - HIGH FEED END MILL (4 AND/OR 6 FLUTE) OPERATING GUIDELINES

Series 47A, 48A

Workpiece Material	Diameter / Programming radius in	cutting speed Vc in/min	feed per tooth		recommended cutting depth ap (in)
			fz (in)		
Unalloyed steel P	.250 R.040	650 - 950	.012		.012
	.312 R.065	650 - 950	.015		.015
	.375 R.080	650 - 950	.020		.020
	.500 R.100	650 - 950	.020		.025
	.625 R.125	650 - 950	.025		.030
	.750 R.160	650 - 950	.030		.040
	1.00 R.145	650 - 950	.030		.045
High Carbon steel P	.250 R.040	600 - 850	.012		.012
	.312 R.065	600 - 850	.015		.015
	.375 R.080	600 - 850	.020		.020
	.500 R.100	600 - 850	.020		.025
	.625 R.125	600 - 850	.025		.030
	.750 R.160	600 - 850	.030		.040
	1.00 R.145	600 - 850	.030		.045
Alloyed / Tool steel < 1400N/mm ² P	.250 R.040	500 - 700	.012		.008
	.312 R.065	500 - 700	.015		.012
	.375 R.080	500 - 700	.020		.015
	.500 R.100	500 - 700	.020		.020
	.625 R.125	500 - 700	.025		.025
	.750 R.160	500 - 700	.030		.030
	1.00 R.145	500 - 700	.030		.040
Stainless steel M	.250 R.040	450 - 650	.012		.008
	.312 R.065	450 - 650	.015		.012
	.375 R.080	450 - 650	.020		.015
	.500 R.100	450 - 650	.020		.020
	.625 R.125	450 - 650	.025		.025
	.750 R.160	450 - 650	.030		.030
	1.00 R.145	450 - 650	.030		.040
Gray cast iron K	.250 R.040	650 - 950	.012		.012
	.312 R.065	650 - 950	.015		.015
	.375 R.080	650 - 950	.020		.020
	.500 R.100	650 - 950	.020		.025
	.625 R.125	650 - 950	.025		.030
	.750 R.160	650 - 950	.030		.040
	1.00 R.145	650 - 950	.030		.045
Cast alloys K	.250 R.040	500 - 700	.012		.008
	.312 R.065	500 - 700	.015		.012
	.375 R.080	500 - 700	.020		.015
	.500 R.100	500 - 700	.020		.020
	.625 R.125	500 - 700	.025		.025
	.750 R.160	500 - 700	.030		.030
	1.00 R.145	500 - 700	.030		.040

OPERATING GUIDELINES

CHIP SURFER™, ROUND LINE - HIGH FEED END MILL (4 AND/OR 6 FLUTE) OPERATING GUIDELINES

Series 47A, 48A

Workpiece Material	Diameter / Programming radius in	cutting speed Vc in/min	feed per tooth fz (in)	recommended cutting depth ap (in)
Super alloys S	.250 R.040	130 - 250	.008	.004
	.312 R.065	130 - 250	.008	.008
	.375 R.080	130 - 250	.012	.012
	.500 R.100	130 - 250	.012	.012
	.625 R.125	130 - 250	.015	.020
	.750 R.160	130 - 250	.015	.020
	1.00 R.145	130 - 250	.018	.020
Hardened steel < 50 HRC	.250 R.040	300 - 450	.012	.004
	.312 R.065	300 - 450	.012	.008
	.375 R.080	300 - 450	.015	.012
	.500 R.100	300 - 450	.015	.012
	.625 R.125	300 - 450	.020	.020
	.750 R.160	300 - 450	.020	.020
	1.00 R.145	300 - 450	.020	.020
Hardened steel < 58 HRC	.250 R.040	150 - 250	.008	.004
	.312 R.065	150 - 250	.008	.008
	.375 R.080	150 - 250	.012	.008
	.500 R.100	150 - 250	.012	.012
	.625 R.125	150 - 250	.015	.015
	.750 R.160	150 - 250	.015	.015
	1.00 R.145	150 - 250	.015	.015

OPERATING GUIDELINES

SERIES 45A - HI FEED 2 FLUTE END MILLS

Workpiece Material	Diameter / Programming radius	cutting speed	feed per tooth	recommended cutting depth		
	In	Vc ft/min	fz (in)	ap (in)		
Unalloyed steel P	.375 R.08	650 - 950	.015 - .030	.020		
	.500 R.10	650 - 950	.020 - .040	.035		
	.625 R.12	650 - 950	.025 - .040	.040		
	.750 R.12	650 - 950	.025 - .040	.055		
High Carbon steel P	.375 R.08	600 - 850	.012 - .027	.018		
	.500 R.10	600 - 850	.015 - .030	.025		
	.625 R.12	600 - 850	.015 - .030	.027		
	.750 R.12	600 - 850	.020 - .030	.035		
Alloyed / Tool Steel P	.375 R.08	500 - 700	.012 - .027	.012		
	.500 R.10	500 - 700	.015 - .030	.015		
	.625 R.12	500 - 700	.015 - .030	.018		
	.750 R.12	500 - 700	.020 - .030	.027		
Stainless Steel M	.375 R.08	450 - 650	.012 - .025	.012		
	.500 R.10	450 - 650	.012 - .030	.015		
	.625 R.12	450 - 650	.020 - .030	.018		
	.750 R.12	450 - 650	.020 - .030	.027		
Gray Cast Iron K	.375 R.08	650 - 950	.015 - .030	.020		
	.500 R.10	650 - 950	.020 - .040	.035		
	.625 R.12	650 - 950	.025 - .040	.040		
	.750 R.12	650 - 950	.025 - .040	.055		
Cast alloys K	.375 R.08	500 - 700	.012 - .027	.018		
	.500 R.10	500 - 700	.015 - .030	.025		
	.625 R.12	500 - 700	.015 - .030	.027		
	.750 R.12	500 - 700	.020 - .030	.035		
Super alloys S	.375 R.08	130 - 250	.010 - .020	.007		
	.500 R.10	130 - 250	.010 - .020	.012		
	.625 R.12	130 - 250	.012 - .025	.015		
	.750 R.12	130 - 250	.012 - .025	.020		
Hardened Steel <50 HRC	.375 R.08	300 - 450	.010 - .015	.007		
	.500 R.10	300 - 450	.010 - .015	.012		
	.625 R.12	300 - 450	.012 - .020	.015		
	.750 R.12	300 - 450	.012 - .020	.020		
Hardened Steel <58 HRC	.375 R.08	150 - 250	.010 - .015	.007		
	.500 R.10	150 - 250	.010 - .015	.012		
	.625 R.12	150 - 250	.012 - .020	.015		
	.750 R.12	150 - 250	.012 - .020	.018		

OPERATING GUIDELINES

SERIES 45Z - CENTER DRILL OPERATING GUIDELINES

ISO	Material Number	Cutting Speed (SFM)	Feed (in/rev) Ø.118 - Ø.185	Feed (in/rev) Ø.189 - Ø.292	Feed (in/rev) Ø.295 - Ø.396	Feed (in/rev) Ø.397 - Ø.500
P	1	250 - 450	.002" - .006"	.003" - .007"	.005" - .010"	.006" - .012"
	2	250 - 450	.002" - .006"	.003" - .007"	.005" - .010"	.006" - .012"
	3	150 - 400	.002" - .004"	.003" - .005"	.005" - .008"	.006" - .010"
	4	150 - 400	.002" - .004"	.003" - .005"	.005" - .008"	.006" - .010"
	5	150 - 400	.002" - .004"	.003" - .005"	.005" - .008"	.006" - .010"
	6	120 - 250	.002" - .004"	.002" - .005"	.004" - .007"	.005" - .009"
	7	120 - 250	.002" - .004"	.002" - .005"	.004" - .007"	.005" - .009"
	8	120 - 250	.002" - .004"	.002" - .005"	.004" - .007"	.005" - .009"
	9	120 - 250	.002" - .004"	.002" - .005"	.004" - .007"	.005" - .009"
	10	100 - 240	.002" - .004"	.002" - .004"	.004" - .006"	.005" - .009"
	11	100 - 240	.002" - .004"	.002" - .004"	.004" - .006"	.005" - .009"
M	12	190 - 230	.002" - .004"	.002" - .004"	.003" - .006"	.005" - .008"
	13	160 - 200	.002" - .004"	.002" - .005"	.004" - .007"	.006" - .009"
	14	110 - 200	.002" - .004"	.002" - .004"	.003" - .006"	.005" - .008"
K	15	230 - 300	.005" - .008"	.007" - .011"	.009" - .015"	.012" - .020"
	16	230 - 300	.005" - .008"	.007" - .011"	.009" - .015"	.012" - .020"
	17	260 - 330	.006" - .010"	.008" - .013"	.011" - .017"	.013" - .024"
	18	260 - 330	.006" - .010"	.008" - .013"	.011" - .017"	.013" - .024"
	19	260 - 330	.006" - .010"	.008" - .013"	.011" - .017"	.013" - .024"
	20	260 - 330	.006" - .010"	.008" - .013"	.011" - .017"	.013" - .024"
N	21	300 - 400	.004" - .010"	.007" - .014"	.009" - .017"	.012" - .020"
	22	300 - 400	.004" - .010"	.007" - .014"	.009" - .017"	.012" - .020"
	23	300 - 400	.004" - .010"	.007" - .014"	.009" - .017"	.012" - .020"
	24	300 - 400	.004" - .010"	.007" - .014"	.009" - .017"	.012" - .020"
	25	300 - 400	.004" - .010"	.007" - .014"	.009" - .017"	.012" - .020"
	26	300 - 400	.003" - .007"	.007" - .014"	.009" - .017"	.012" - .020"
	27	300 - 400	.003" - .007"	.007" - .014"	.009" - .017"	.012" - .020"
	28	300 - 400	.003" - .007"	.007" - .014"	.009" - .017"	.012" - .020"
	29					
	30					
S	31	30 - 80	.001" - .003"	.002" - .003"	.003" - .004"	.004" - .005"
	32	30 - 80	.001" - .003"	.002" - .003"	.003" - .004"	.004" - .005"
	33	30 - 80	.001" - .003"	.002" - .003"	.003" - .004"	.004" - .005"
	34	30 - 80	.001" - .003"	.002" - .003"	.003" - .004"	.004" - .005"
	35	30 - 80	.001" - .003"	.002" - .003"	.003" - .004"	.004" - .005"
	36	70 - 140	.001" - .003"	.002" - .004"	.003" - .006"	.004" - .008"
	37	70 - 140	.001" - .003"	.002" - .004"	.003" - .006"	.004" - .008"
H	38	50 - 100	.001" - .002"	.001" - .003"	.001" - .003"	.002" - .004"
	39	50 - 100	.001" - .002"	.001" - .003"	.001" - .003"	.002" - .004"
	40	50 - 100	.001" - .002"	.001" - .003"	.001" - .003"	.002" - .004"
	41	50 - 100	.001" - .002"	.001" - .003"	.001" - .003"	.002" - .004"

●=P ●=M ●=K ●=N ●=S ○=H

OPERATING GUIDELINES

SERIES 47Y - OPERATING GUIDELINES FOR SOLID CARBIDE THREAD MILLS

Main ISO-group	Workpiece Material	Remark	Tensile Strength	Hardness	Machin. Group
P	< 0,25 % C	Annealed	420	125	1
	Unalloyed steel >= 0,25 % C	Annealed	650	190	2
	Cast steel < 0,25 % C	Tempered	850	250	3
	Free cutting steel >= 0,55 % C	Annealed	750	220	4
		Tempered	1000	300	5
	Steel medium tensile strength	Annealed	600	200	6
	and cast steel	Tempered	930	275	7
	(with less than 5 % C)	Tempered	1000	300	8
		Tempered	1200	350	9
	High-alloyed cast steel	Annealed	680	200	10
	Steel and tool steel	Tempered	1100	325	11
M	Stainless steel	Ferritic, martensitic	680	200	12
	and cast steel	Martensitic	820	240	13
		Austenitic	600	180	14
K	Nodular gray cast iron	Ferritic, pearlitic	-	180	15
	(GGG)	Pearlitic	-	260	16
	Gray cast iron	Ferritic	-	160	17
	(GG)	Pearlitic	-	250	18
	Malleable cast iron	Ferritic	-	130	19
	Malleable cast iron	Pearlitic	-	230	20
N	Aluminum-wrought alloy	Untreated	-	60	21
	Aluminum-wrought alloy	Forged, alloyed	-	100	22
	Aluminum cast alloy	Untreated	-	75	23
	Aluminum cast alloy	Forged, alloyed	-	90	24
	Aluminum cast alloy >12 % Si	High temp. resist.	-	130	25
	Copper alloys	Easy to machine	-	110	26
	CuZn-alloys (brass)		-	90	27
	Elektrolytic copper		-	100	28
	Duroplastics		-	90	29
	Graphite		-	-	30
Ebonite		-	-	-	
S	High temp. resisting alloys .	Fe-base, tempered	-	200	31
	Superalloys	Ni/Co-base, treated	-	280	32
	Superalloys	Ni/Co-base, tempered	-	250	33
	Superalloys	Ni/Co-base, treated	-	350	34
	Titanium, cast		-	320	35
	Titanium		400	-	36
	Titanium alloys	Alpha & beta alloy, treated	1050	-	37
H	Hardened steel	Hardened	-	55 HRC	38
	Hardened steel	Hardened	-	60 HRC	39
	Chill casting	Cast	400	-	40
	Cast iron	Hardened	-	55 HRC	41

OPERATING GUIDELINES







SERIES 47Y - OPERATING GUIDELINES FOR SOLID CARBIDE THREAD MILLS

IN 2005 (ft/min)	Feed (in/tooth) - Cutting Diameter											
	Ø 0.078	Ø 0.125	Ø 0.156	Ø 0.250	Ø 0.312	Ø 0.390	Ø 0.484	Ø 0.562	Ø 0.625	Ø 0.781	Ø 0.984	Ø 1.181
330-1085	0.001	0.002	0.002	0.002	0.003	0.003	0.004	0.004	0.005	0.006	0.007	0.008
265-690	0.001	0.002	0.002	0.002	0.003	0.003	0.004	0.004	0.005	0.006	0.007	0.008
215-600	0.001	0.002	0.002	0.002	0.003	0.003	0.004	0.004	0.005	0.006	0.007	0.008
360-590	0.001	0.001	0.001	0.002	0.002	0.003	0.003	0.004	0.004	0.005	0.006	0.007
315-525	0.001	0.001	0.001	0.002	0.002	0.003	0.003	0.004	0.004	0.005	0.006	0.007
300-525	0.001	0.001	0.001	0.001	0.002	0.002	0.002	0.002	0.003	0.003	0.004	0.004
215-660	0.001	0.001	0.001	0.001	0.002	0.002	0.002	0.002	0.003	0.003	0.004	0.004
230-690	0.001	0.001	0.001	0.001	0.002	0.002	0.002	0.002	0.003	0.003	0.004	0.004
315-525	0.001	0.001	0.001	0.001	0.002	0.002	0.002	0.002	0.003	0.003	0.004	0.004
430-600	0.001	0.001	0.001	0.001	0.002	0.002	0.002	0.002	0.003	0.003	0.004	0.004
245-330	0.001	0.001	0.001	0.001	0.002	0.002	0.002	0.002	0.003	0.003	0.004	0.004
360-600	0.001	0.001	0.001	0.001	0.002	0.002	0.002	0.002	0.003	0.003	0.004	0.004
230-510	0.001	0.001	0.001	0.001	0.002	0.002	0.002	0.002	0.003	0.003	0.004	0.004
280-330	0.001	0.001	0.001	0.001	0.002	0.002	0.002	0.002	0.003	0.003	0.004	0.004
230-495	0.001	0.002	0.002	0.002	0.003	0.003	0.004	0.004	0.005	0.006	0.007	0.008
360-500	0.001	0.002	0.002	0.002	0.003	0.003	0.004	0.004	0.005	0.006	0.007	0.008
400-525	0.001	0.002	0.002	0.002	0.003	0.003	0.004	0.004	0.005	0.006	0.007	0.008
245-525	0.001	0.002	0.002	0.002	0.003	0.003	0.004	0.004	0.005	0.006	0.007	0.008
400-525	0.001	0.002	0.002	0.002	0.003	0.003	0.004	0.004	0.005	0.006	0.007	0.008
360-500	0.001	0.002	0.002	0.002	0.003	0.003	0.004	0.004	0.005	0.006	0.007	0.008
525-985	0.001	0.002	0.002	0.002	0.003	0.003	0.004	0.004	0.005	0.006	0.007	0.008
-	-	-	-	-	-	-	-	-	-	-	-	-
-	-	-	-	-	-	-	-	-	-	-	-	-
-	-	-	-	-	-	-	-	-	-	-	-	-
-	-	-	-	-	-	-	-	-	-	-	-	-
-	-	-	-	-	-	-	-	-	-	-	-	-
-	-	-	-	-	-	-	-	-	-	-	-	-
-	-	-	-	-	-	-	-	-	-	-	-	-
330-1315	0.002	0.002	0.003	0.004	0.004	0.004	0.005	0.005	0.006	0.007	0.009	0.010
-	-	-	-	-	-	-	-	-	-	-	-	-
-	-	-	-	-	-	-	-	-	-	-	-	-
-	-	-	-	-	-	-	-	-	-	-	-	-
65-265	0.001	0.001	0.001	0.001	0.001	0.001	0.001	0.002	0.002	0.002	0.002	0.002
-	-	-	-	-	-	-	-	-	-	-	-	-
-	-	-	-	-	-	-	-	-	-	-	-	-
-	-	-	-	-	-	-	-	-	-	-	-	-
65-265	0.001	0.001	0.001	0.001	0.001	0.001	0.001	0.002	0.002	0.002	0.002	0.002
180-215	0.001	0.001	0.001	0.001	0.001	0.001	0.001	0.002	0.002	0.002	0.002	0.002
150-180	0.001	0.001	0.001	0.001	0.001	0.001	0.001	0.002	0.002	0.002	0.002	0.002
300-345	0.001	0.001	0.001	0.001	0.001	0.001	0.001	0.002	0.002	0.002	0.002	0.002
180-215	0.001	0.001	0.001	0.001	0.001	0.001	0.001	0.002	0.002	0.002	0.002	0.002

For cutters with long cutting flute reduce feed rate by 40 %.

OPERATING GUIDELINES

CHIP SURFER T-SLOTTER (18T) OPERATING GUIDELINES

Workpiece Material		Full Slot		Side Cut	
Cutting Speed	Feed rate per tooth	Cutting Speed	Feed rate per tooth	Cutting Speed	Feed rate per tooth
					
Vc (ft)	Fz (in)	Vc (ft)	Fz (in)	Vc (ft)	Fz (in)

Steel P	300-400	.002-.006	500-700	.001-.006		
Tool Steel P	200-350	.001-.004	500-650	.001-.006		
Stainless Steel M	250-400	.001-.006	250-450	.002-.006		
Gray Cast Iron K	400-650	.001-.004	500-800	.002-.006		
Super Alloys S	100-200	.001-.004	100-225	.001-.004		
Aluminum N	1000-2500	.004-.008	1000-4000	.004-.008		
Copper	250-350	.004-.006	450-800	.004-.008		

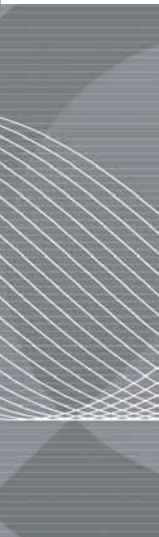
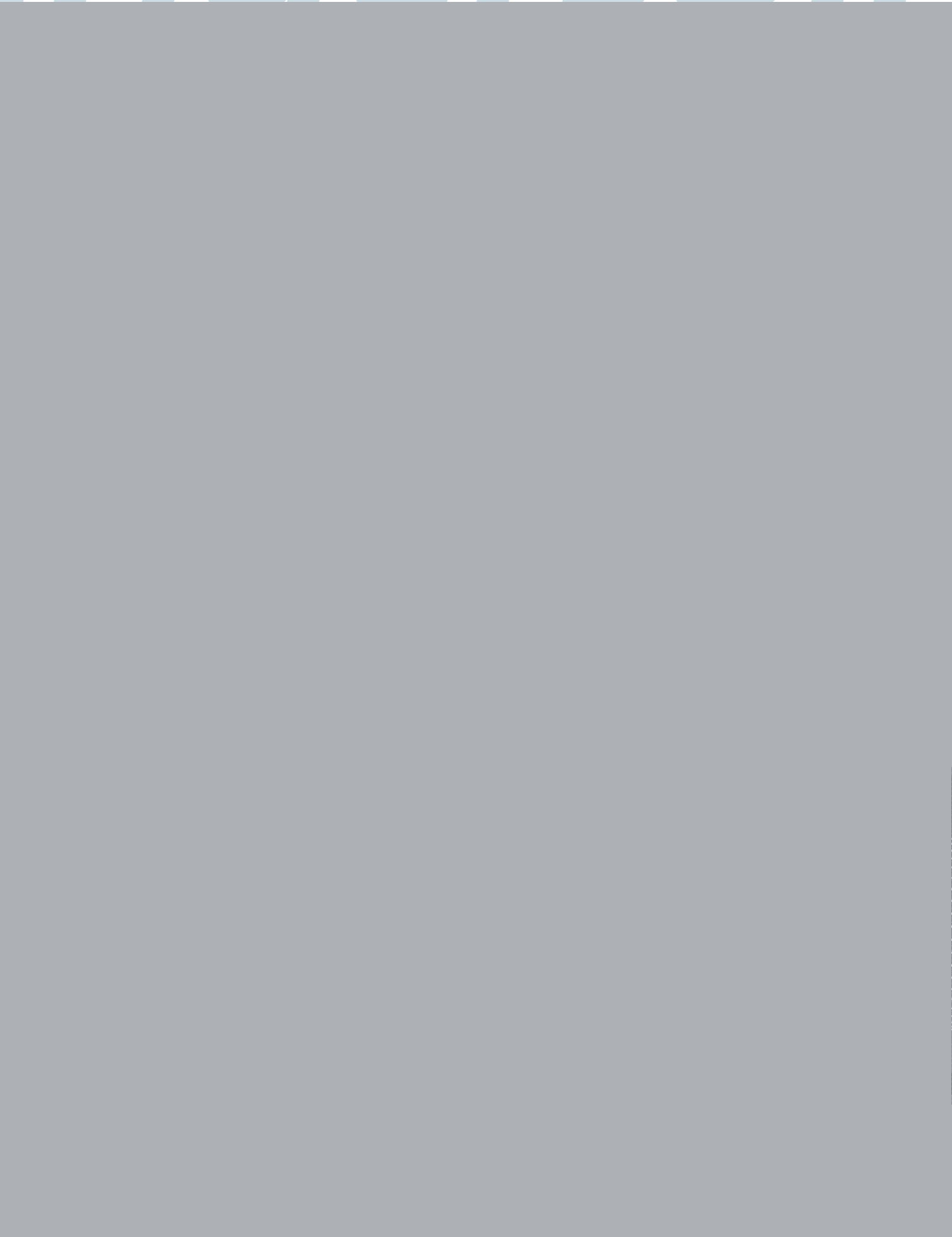



SR003-1M30

Ingersoll

END MILLS

EXTENDED FLUTE END MILLS

SHOULDER-TYPE FACE MILLS

FACE MILLS

SLOT MILLS

FORM MILLS

COPY & PLUNGING MILLS

SOLID CARBIDE MILLING CUTTERS

THREAD & BORING TOOLS

Ingersoll



CUTTING TOOLS

THREAD & BORING TOOLS.

Cutting Tools



Member IMC Group
Ingersoll
Cutting Tools

THREAD & BORING TOOLS.

	Diameter	Cutting Length	Description	Series	Page
	.782 - .842	.39 - .42	SPOT-IN Indexable Spotting Drill Using Triangle Insert	FAK (Triangle Insert)	490
	.685 - .761	.12 - .20	SPOT-IN Indexable Spotting Drill Using Quad Insert	FAK (Quad Insert)	491
	.472 - .630	.08 - .31	SPOT-IN Replaceable Point Spotting Drills	Y	493
	.188 - .472	24mm - 60mm	DRILL-IN Solid Carbide Drills	DR	494
	.250in - 10mm	5.79in - 225mm	DRILL-IN XL Solid Carbide Drills	DRXL	497
	.2953 - 1.0197	.87 - 2.95	QWIK-TWIST Replaceable Point Drills	Y - 3:1	498
	.2953 - 1.0197	1.46 - 4.92	QWIK-TWIST Replaceable Point Drills	Y - 5:1	500
	.3937 - 1.0197	3.150 - 7.870	QWIK-TWIST Replaceable Point Drills	Y - 8:1	502
	.2953 - .8228	.81 - 2.50	QWIK-TWIST Slip Fit Chamfer Shanks - (Straight Shanks w/Whistle Notch Flat)	MHK	504
	.2953 - .8228	1.020 - 2.600	QWIK-TWIST Slip Fit Drills	Y - 3:5:1	506

	Diameter	Cutting Length	Description	Series	Page
	.2677 - .8622	.827 - 1.98	QWIKTWIST™ Tap Drill/Chamfer Combo	YC	508
	1.26 - 2.05		QWIKTWIST™ Chamfer Rings	CB	510
	.500 - 2.00	1.00 - 4.00	QUAD•DRILL+ Square Insert Indexable Drills	Q - 2:1	518
	.500 - 2.00	1.50 - 6.00	QUAD•DRILL+ Square Insert Indexable Drills	Q 3:1	520
	.500 - 2.000	2.00 - 8.00	QUAD•DRILL+ Square Insert Indexable Drills	Q - 4:1	522
	.500 - 1.625	2.50 - 8.12	QUAD•DRILL+ Square Insert Indexable Drills	Q - 5:1	524
	2.125 - 3.250	4.25 - 6.50	QUAD•DRILL Large Indexable Drills	Q - 2:1 Large	525
	2.125 - 3.250	6.38 - 9.75	QUAD•DRILL Large Indexable Drills	Q - 3:1 Large	526
	2.125 - 3.250	8.50 - 13.00	QUAD•DRILL Large Indexable Drills	Q - 4:1 Large	527
	2.125 - 3.125	4.41 - 6.25	QUAD•DRILL+ Adjustable Cartridge Drills	QA - 2XD	530







THREAD & BORING TOOLS.

	Diameter	Cutting Length	Description	Series	Page
	2.125 - 3.125	6.61 - 9.38	QUAD•DRILL⁺ Adjustable Cartridge Drills	QA - 3XD	531
	.625 - 2.000	1.88 - 6.00	QUAD•DRILL⁺ Indexable Flat Bottom Drill	QF - 3:1	534
	1.000 - 1.500		QUAD•DRILL⁺ Eccentric Adjustment Bushings	BU	537
	.500 - 2.000	.50 - 2.0	QUAD•BORE[™] Center-Cutting Bore Tools	15S	538
	.438 - 2.000	.44 - 2.0	QUAD•BORE[™] Indexable Counter Boring Tools	15C	540
	.453 - 1.260	.366 - .504	QWIK•REAM[™] Qwik Ream Shanks - Inch	XS	542
	11.5mm - 32mm	9.33mm - 12.8mm	QWIK•REAM[™] Qwik Ream Shanks - Metric	XS (Metric)	543
	.500 - 1.250		QWIK•REAM[™] Carbide Reaming Head - Inch	XLB	544
	12mm - 32mm		QWIK•REAM[™] Carbide Reaming Head - Metric	XLB (Metric)	545
	.500 - 1.250		QWIK•REAM[™] Carbide Reaming Head - Inch	XSA	546

	Diameter	Cutting Length	Description	Series	Page
	12mm - 32mm		QWIKREAM™ Carbide Reaming Head - Metric	XSA (Metric)	547
	.098 - .750	.240 - 1.780	RAPID THREAD™ Solid Carbide Thread Mills - Internal for UN Thread	46Y_UN, 47Y_UN	548
	.087 - .750	.210 - 1.710	RAPID THREAD™ Solid Carbide Thread Mills - Internal for ISO Thread	46Y_IS_RA, 47Y_IS_RA	549
			RAPID THREAD™ Solid Carbide Thread Mills - External or Internal NPT Thread	46Y_NPT, 47Y_NPT	550
			RAPID THREAD™ Solid Carbide Thread Mills - External or Internal NPTF Thread	46Y_NPTF, 47Y_NPTF	551
	.045 - .567	.160 - 1.630	RAPID THREAD™ Solid Carbide Thread Mills - Small Dia. Short, UN, 2XD & 3XD	46Y_UN_RM, 47Y_UN_RM	552
	.061 - .591	.180 - 1.690	RAPID THREAD™ Solid Carbide Thread Mills - Small Dia. Short, ISO, 2XD & 3XD	46Y_IS_RM, 47Y_IS_RM	553
	.057 - .362	.150 - 1.080	RAPID THREAD™ Solid Carbide Thread Mills - Sm. Dia. Short, LH, UN, 2XD & 3XD	46Y_UN_LM	554
	.061 - .354	.252 - .445	RAPID THREAD™ Solid Carbide Thread Mills - Dia. Short, LH, ISO, 2XD & 3XD	46Y_IS_LM, 47Y_IS_LM, 48Y_IS_LM	555
	.394 - .630	.252 - .445	RAPID THREAD™ Solid Carbide Thread Milling Tip - Internal for UN Thread (Chip-Surfer Style)	47Y_UN_RA (Chip-Surfer Style)	556

THREAD & BORING TOOLS.

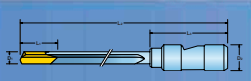
	Diameter	Cutting Length	Description	Series	Page
	.394 - .630	.236 - .472	RAPID•THREAD Solid Carbide Thread Milling Tip - Internal for ISO Thread	47Y_IS_RA (Chip-Surfer Style)	557
	.370 - .390	.472	RAPID•THREAD Indexable Thread Mills	12Y1H (12mm)	558
	.500 - .790	.551	RAPID•THREAD Indexable Thread Mills	12Y1J (14mm)	560
	.790 - 1.180	.827	RAPID•THREAD Indexable Thread Mills	12Y1N (21mm)	562
	1.140 - 1.580	1.181	RAPID•THREAD Indexable Thread Mills	12Y1S (30mm)	564
	1.730 - 1.970	1.575	RAPID•THREAD Indexable Thread Mills	12Y1U (40mm)	566
	.490 - .620	.551	RAPID•THREAD Indexable Thread Mills - Carbide Shank	12Y5J (14mm)	568
	.820	.827	RAPID•THREAD Indexable Thread Mills - Carbide Shank	12Y5N (21mm)	570
	2.480	.827	RAPID•THREAD Indexable Thread Mills - Shell Mill	12Y1N_D (21mm)	572
	2.480 - 3.940	1.181	RAPID•THREAD Indexable Thread Mills - Shell Mill	12Y1S_D (30mm)	574

	Diameter	Cutting Length	Description	Series	Page
	3.150 - 3.940	1.575	RAPID THREAD Indexable Thread Mills - Shell Mill	12Y1U_D (40mm)	576
	1.060	.900	RAPID THREAD Indexable Thread Mills - Helical End Mill	22Y3Q (23mm)	578
	1.260	-	RAPID THREAD Indexable Thread Mills - Helical End Mill	22Y3R (32mm)	579
	1.457	1.450	RAPID THREAD Indexable Thread Mills - Helical End Mill	22Y3S (37mm)	580
	1.496	1.490	RAPID THREAD Indexable Thread Mills - Helical End Mill	22Y3T (38mm)	581
	.100 - 1.575	5.9 - 118.0	Single Flute Brazed Gun Drills	GD SPGD	582
	.035 - .630	40 x D to 7.874	Solid Carbide Gun Drills	SCGD	583
	.125 - 1.000	10 - 60	Standard Brazed Gun Drills	STGD	584
	1.496 - 4.212	100 x D	BTA Indexable Drill - 3 Cartridge, Single Tube System - Outer Four Start Thread	TBTA3_SE4	597
	1.496 - 4.212	100 x D	BTA Indexable Drill, 3 Cartridge Inner Single Start Thread	TBTA3_SI1	598

THREAD & BORING TOOLS.

	Diameter	Cutting Length	Description	Series	Page
	1.496 - 4.212	100 x D	BTA Indexable Drill - 3 Cartridge, Double Tube System - Outer Four Start Thread	TBTA3_DE4	599
	4.213 - 6.653	100 x D	BTA Indexable Drill - 5 Cartridge Single Tube System - Outer Four Start Thread	TBTA5_SE4	603
	4.213 - 6.653	100 x D	BTA Indexable Drill - 5 Cartridge Single Tube System - Inner Single Start Thread	TBTA5_S11	604
	4.213 - 6.653	100 x D	BTA Indexable Drill - 5 Cartridge, Double Tube System - Outer Four Start Thread	TBTA5_DE4	605
	6.654 - 9.173	100 x D	BTA Indexable Drill - 7 Cartridge, Single Tube System - Outer Four Start Head	TBTA7_SE4	608
	6.654 - 9.685	100 x D	BTA Indexable Drill - 7 Cartridge, Single Tube System - Inner Single Start Thread	TBTA7_S11	609
	1.142 - 1.496	100 x D	BTA Indexable Drill for Small Diameters - Single Tube System, Outer Four Start Thread	TBTA-A_SE4	613
	1.142 - 1.496	100 x D	BTA Indexable Drill for Small Diameters - Single Tube System, Inner Single Start Thread	TBTA-A_S11	614
	.630 - 1.122	100 x D	BTA Indexable Drills for Small Diameters - Single Tube System, Outer Four Start Thread	TBTA-B_SE4	617
	.630 - 1.122	100 x D	BTA Indexable Drill for Small Diameters - Single Tube System - Inner Single Start Thread	TBTA-B_S11	618

	Diameter	Cutting Length	Description	Series	Page
	.984 - 2.094	100 x D	BTA Indexable Drills - Single Tube System - Outer Four Start Thread	TBTA-C_SE4	621
	.984 - 2.094	100 x D	BTA Indexable Drills - Double Tube System - Outer Four Start Thread	TBTA-C_DE4	622
	1.181 - 2.559	100 x D	BTA Indexable Drills - Single Tube System - Outer Four Start Thread	TBTA-D_SE4	625
	1.181 - 2.559	100 x D	BTA Indexable Drills - Single Tube System - Outer Four Start Thread	TBTA-D_DE4	626
	2.441 - 7.244	100 x D	BTA Indexable Drills for Large Diameters - Single Tube System - Outer Four Start Thread	TBTA-L_SE4	630
	.496 - 1.559	100 x D	BTA Drills Brazed Single Tube System - Outer Four Start Thread	BTA_SE4	633
	1.559 - 2.559	100 x D	BTA Drills Brazed Single Tube System - Outer Four Start Thread	BTA_SE4	634
	.725 - 1.559	100 x D	BTA Drills Brazed Double Tube System - Outer Four Start Thread	BTA_DE4	635
	1.559 - 2.559	100 x D	BTA Drills Brazed Double Tube System - Outer Four Start Thread	BTA_DE4	636
	.496 - .787	100 x D	BTA Drills Brazed Single Tube System - Outer Two Start and Four Start Thread	BTS_SE4	637

THREAD & BORING TOOLS.

	Diameter	Cutting Length	Description	Series	Page
	.315 - .570	100 x D	BTA Drill Brazed Single Tube System Outer Single Start Thread	BTS_SE1	638
	.571 - 2.559	100 x D	BTA Drill Brazed Single Tube System Inner Single Start Thread	BTS_SI1	639
	.984 - 1.574	100 x D	BTA Indexable Reamers Single Tube System Outer Four Start Thread	TBTA-R_SE4	643
	1.575 - 3.937	100 x D	BTA Indexable Reamers Single Tube System Outer Four Start Thread	TBTA-R_SE4-3	644
	.984 - 1.574	100 x D	BTA Indexable Reamers Single Tube System Inner Single Start Thread	TBTA-R_SI1	645
	1.575 - 4.370	100 x D	BTA Indexable Reamers Single Tube System Inner Single Start Thread	TBTA-R_SI1	646
	.571 - 2.559	100 x D	Head Change Reamers Single Tube System Inner Single Start Thread	BTA-R_SI1	650
	.744 - 2.559	100 x D	Head Change Reamers Single Tube System Outer Four Start Head	BTA-R_SE4	651
	.725 - 2.559	100 x D	Head Change Reamers Single Tube System Outer Four Start Head	BTA-R_DE4	652
	.236 - .984	100 x D	BTA Reamer Head - Shank System	BTRS	654

	Diameter	Cutting Length	Description	Series	Page
	.236 - .984	1.57 - 5.91	BTA Reamer Head Shank System	BTRW	655
	.236 - .984	1.57 - 5.91	BTA Reamer Head Shank System	BTRM	656
	.236 - .984	3.54 - 5.91	BT Reamer Bar for BTA Reamer Heads MT Shank	BTRO_MT	657
	.236 - .984	1.57 - 3.94	BT Reamer Bar for BTA Reamer Heads ST Shank	BTR_ST	657
	.433 - 8.898	-	Tube Single Tube System Inner Four Start Thread	BTSI	658
	.472 - 8.898	-	Tube Single Tube System Outer Single Start Thread	BTSE	659
	.280 - .472	-	Tube Single Tube System Outer Single Start Thread	BTSO	660
	.709 - 6.063	-	Double Tube System Inner Four Start Thread	BTDO, BTDI	661
	.724 - 4.878		Adaptor Type 'S'	DTC_S	662
	.724 - 7.240		Adaptor Type 'R'	DTC_R	662



THREAD & BORING TOOLS.

	Diameter	Cutting Length	Description	Series	Page
	.724 - 4.878		Adaptor Type 'RF'	DTC_RF	662
	.725 - 2.559		Collet	CT_#	663
	.725 - 2.559		Sealing Sleeve	SS_#	663

	Diameter	Cutting Length	Description	Series	Page

SPOT-IN™ FAK (TRIANGLE INSERT)

INDEXABLE SPOTTING DRILL USING TRIANGLE INSERT

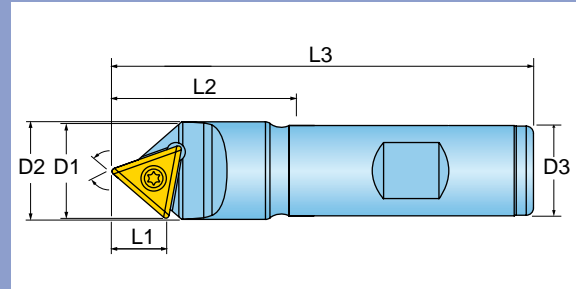

Part Number	Included Angle	D1 Max. Diam. Of Spot (inch)	D1 Max. Diam. Of Spot (mm)	L1 Maximum Depth of Cut	D2 Overall Diameter	L2 Extension from Holder	L3 Overall Length	D3 Shank Size/Style
FAK-0708284R01	82 degrees	0.782	19.86 mm	0.42	0.810	1.50	3.50	.750" Weldon
FAK-0809084R01	90 degrees	0.842	21.39 mm	0.39	0.810	1.50	3.50	.750" Weldon

Operating guidelines on [page 674](#).

INSERTS

TFLT15T303N

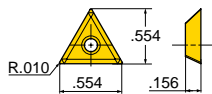

TFLT15T308N

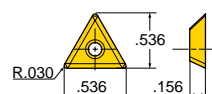

Part Number	Applications	Grade							
TFLT15T303N	Multi-Purpose - 0.010" R	IN1530							
TFLT15T308N	Multi-Purpose - 0.031" R								

○ = P ○ = M ○ = K ○ = N ○ = S

HARDWARE



Screw



Driver

SM30-065-00

DS-T09W

SPOTOIN™ FAK (QUAD INSERT)

INDEXABLE SPOTTING DRILL USING QUAD INSERT



Chamfer



Spot Drilling



C-sink/Chamfer

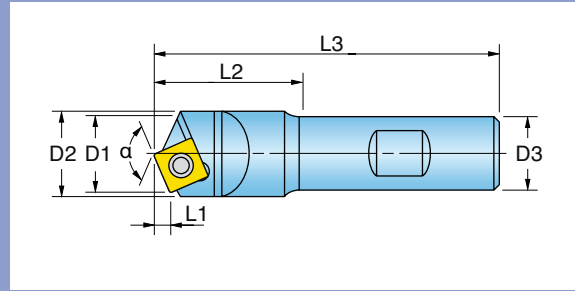

Part Number	Included Angle	D1 Max. Diam. Of Spot (inch)	D1 Max. Diam. Of Spot (mm)	L1 Maximum Depth of Cut	D2 Overall Diameter	L2 Extension from Holder	L3 Overall Length	D3 Shank Size/Style
FAK-0611884R01	118 degrees	0.685	17.40 mm	0.20	0.880	1.50	3.50	.750" Weldon
FAK-0713584R01	135 degrees	0.738	18.75 mm	0.15	0.880	1.50	3.50	.750" Weldon
FAK-0714484R01	144 degrees	0.761	19.33 mm	0.12	0.880	1.50	3.50	.750" Weldon

Operating guidelines on [page 674](#).

INSERTS

SELW100403N



Part Number

Applications

Grade

IN1530

SELW100403N

Multi-Purpose - 0.010" R



○ = P ● = M ● = K ● = N ● = S

HARDWARE



Screw



Driver

SM40-093-20

DS-T15T

FAK SERIES

- Engrave part numbers, serial numbers, lot numbers, company logos, etc. all in the same machine set-up.
- Utilize the CNC control capability to program the engraving.
- High speed engraving capability up to 100 inches/minute.

Item No.- 5110040
 Insert Part No.- TFLT15T303N
 Grade- IN1530 (Tough wear resistant grade, well suited for engraving)

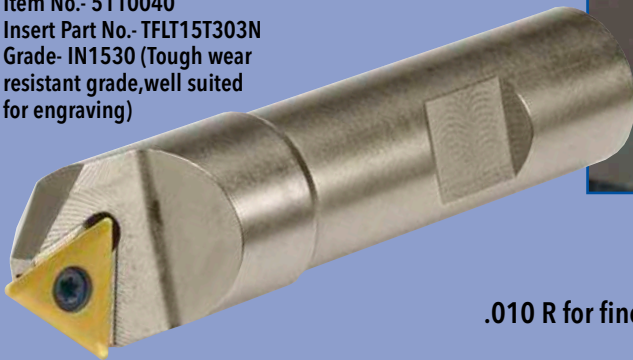

.010 R for fine engraving line width

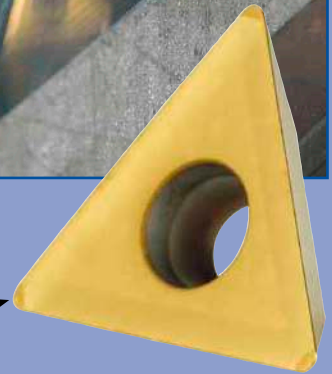

DRILL-PAK™ INDEXABLE SPOTTING DRILL PACKAGES

FAK SERIES



Included Angle	Package Number
82°	FAK-0708284K01
90°	FAK-0809084K01
118°	FAK-0611884K01
135°	FAK-0713584K01
144°	FAK-0714484K01

Spotting drills with indexable strength and convenience

Tooling Package Includes:

- One indexable spotting drill
- Ten inserts
- One Torx® screw driver
- Three additional insert screws
- Durable polypropylene case



REPLACEABLE POINT SPOTTING DRILLS



C-sink/Chamfer



Spot Drilling

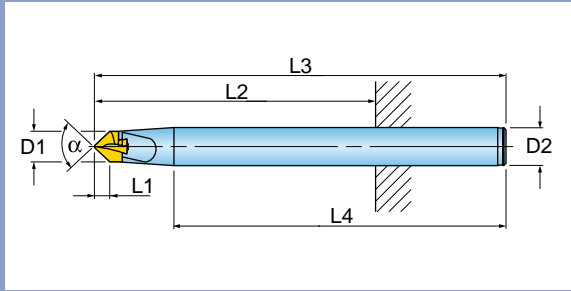

Part Number	D1 Dia. of Spot	D1 Dia. of Spot	L1 Max DOC 90deg Tip	L1 Max DOC 140deg Tip	L2 Max Ext. 90deg Tip	L2 Max Ext. 140deg Tip	L3 O'all Leng. 90deg Tip	L3 O'all Leng. 140deg Tip	L4 Shank Length	D3 Shank Size/Style
YB1200006S5R01	0.472	12mm	0.23	0.08	4.70	4.54	6.00	5.84	4.58	.500" Cyl.
YB1600008S7R01	0.630	16mm	0.31	0.11	6.40	6.20	8.00	7.80	6.50	.750" Cyl.

Operating guidelines on [page 674](#).

INSERTS

YAB1200R01

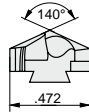

YAB1600R01

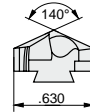

YCB1200R01

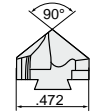

YCB1600R01

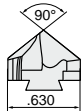

Part Number	Applications	Grade	IN1530	IN2005	IN2030	IN2505					
YAB1200R01	Multi-Purpose - n/a		●	●		●					
YAB1600R01	Multi-Purpose - n/a			●	●	●					
YCB1200R01	Multi-Purpose - n/a				●	●					
YCB1600R01	Multi-Purpose - n/a				●	●					

● = P ● = M ● = K ● = N ● = S

HARDWARE



Clamping Key



Optional Torque Key

YB1200006S5R01	KDCM-12-A	TKDCM-12
YB1600008S7R01	KDCM-16-A	TKDCM-16

SOLID CARBIDE DRILLS

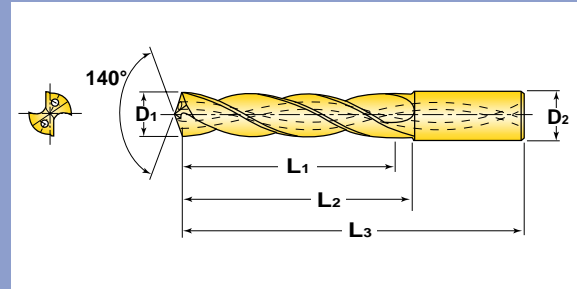

Part Number		D1 Max. Diam. Of Spot (inch)	D1 Max. Diam. Of Spot (mm)	D2 Shank Size/Style	L1 Maximum Depth of Cut	L2 Flute Length	L3 Overall Length
DR0300024T7R01	IN2005	0.118	3.00mm	6mm Cylindrical	24.00mm	28.00mm	66.00mm
DR0310023T7R01	IN2005	0.122	3.10mm	6mm Cylindrical	23.00mm	28.00mm	66.00mm
DR0320023T7R01	IN2005	0.126	3.20mm	6mm Cylindrical	23.00mm	28.00mm	66.00mm
DR0330023T7R01	IN2005	0.130	3.30mm	6mm Cylindrical	23.00mm	28.00mm	66.00mm
DR0340023T7R01	IN2005	0.134	3.40mm	6mm Cylindrical	23.00mm	28.00mm	66.00mm
DR0350023T7R01	IN2005	0.138	3.50mm	6mm Cylindrical	23.00mm	28.00mm	66.00mm
DR0360023T7R01	IN2005	0.142	3.60mm	6mm Cylindrical	23.00mm	28.00mm	66.00mm
DR0370022T7R01	IN2005	0.146	3.70mm	6mm Cylindrical	22.00mm	28.00mm	66.00mm
DR0380030T7R01	IN2005	0.150	3.80mm	6mm Cylindrical	30.00mm	36.00mm	74.00mm
DR0390030T7R01	IN2005	0.154	3.90mm	6mm Cylindrical	30.00mm	36.00mm	74.00mm
DR0400030T7R01	IN2005	0.158	4.00mm	6mm Cylindrical	30.00mm	36.00mm	74.00mm
DR0410030T7R01	IN2005	0.161	4.10mm	6mm Cylindrical	30.00mm	36.00mm	74.00mm
DR0420030T7R01	IN2005	0.165	4.20mm	6mm Cylindrical	30.00mm	36.00mm	74.00mm
DR0430030T7R01	IN2005	0.169	4.30mm	6mm Cylindrical	30.00mm	36.00mm	74.00mm
DR0440029T7R01	IN2005	0.173	4.40mm	6mm Cylindrical	29.00mm	36.00mm	74.00mm
DR0450029T7R01	IN2005	0.177	4.50mm	6mm Cylindrical	29.00mm	36.00mm	74.00mm
DR0460029T7R01	IN2005	0.181	4.60mm	6mm Cylindrical	29.00mm	36.00mm	74.00mm
DR0470029T7R01	IN2005	0.185	4.70mm	6mm Cylindrical	29.00mm	36.00mm	74.00mm
DR0480037T7R01	IN2005	0.189	4.80mm	6mm Cylindrical	37.00mm	44.00mm	82.00mm
DR0490037T7R01	IN2005	0.193	4.90mm	6mm Cylindrical	37.00mm	44.00mm	82.00mm
DR0500037T7R01	IN2005	0.197	5.00mm	6mm Cylindrical	39.00mm	46.00mm	84.00mm
DR0510036T7R01	IN2005	0.201	5.10mm	6mm Cylindrical	38.00mm	46.00mm	84.00mm
DR0520036T7R01	IN2005	0.205	5.20mm	6mm Cylindrical	38.00mm	46.00mm	84.00mm
DR0530036T7R01	IN2005	0.209	5.30mm	6mm Cylindrical	38.00mm	46.00mm	84.00mm
DR0540036T7R01	IN2005	0.213	5.40mm	6mm Cylindrical	38.00mm	46.00mm	84.00mm
DR0550036T7R01	IN2005	0.217	5.50mm	6mm Cylindrical	38.00mm	46.00mm	84.00mm
DR0560036T7R01	IN2005	0.221	5.60mm	6mm Cylindrical	38.00mm	46.00mm	84.00mm
DR0570035T7R01	IN2005	0.224	5.70mm	6mm Cylindrical	37.00mm	46.00mm	84.00mm
DR0580035T7R01	IN2005	0.228	5.80mm	6mm Cylindrical	37.00mm	46.00mm	84.00mm
DR0590035T7R01	IN2005	0.232	5.90mm	6mm Cylindrical	37.00mm	46.00mm	84.00mm
DR0600035T7R01	IN2005	0.236	6.00mm	6mm Cylindrical	37.00mm	46.00mm	84.00mm
DR0610044TOR01	IN2005	0.240	6.10mm	8mm Cylindrical	47.00mm	56.00mm	94.00mm
DR0620044TOR01	IN2005	0.244	6.20mm	8mm Cylindrical	47.00mm	56.00mm	94.00mm
DR0630044TOR01	IN2005	0.248	6.30mm	8mm Cylindrical	47.00mm	56.00mm	94.00mm
DR0640043TOR01	IN2005	0.252	6.40mm	8mm Cylindrical	47.00mm	56.00mm	94.00mm
DR0650043TOR01	IN2005	0.256	6.50mm	8mm Cylindrical	46.00mm	56.00mm	94.00mm
DR0660043TOR01	IN2005	0.260	6.60mm	8mm Cylindrical	46.00mm	56.00mm	94.00mm
DR0670043TOR01	IN2005	0.264	6.70mm	8mm Cylindrical	46.00mm	56.00mm	94.00mm
DR0680043TOR01	IN2005	0.268	6.80mm	8mm Cylindrical	46.00mm	56.00mm	94.00mm
DR0690043TOR01	IN2005	0.272	6.90mm	8mm Cylindrical	46.00mm	56.00mm	94.00mm

SOLID CARBIDE DRILLS



Drilling



Coolant

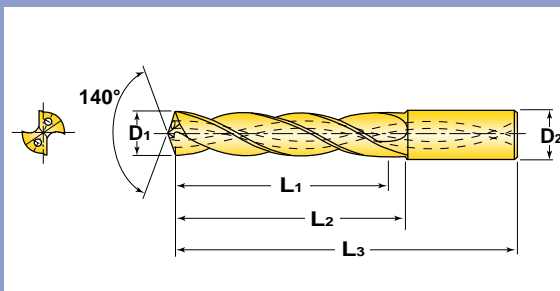

Part Number		D1 Max. Diam. Of Spot (inch)	D1 Max. Diam. Of Spot (mm)	D2 Shank Size/Style	L1 Maximum Depth of Cut	L2 Flute Length	L3 Overall Length
DR0700043TOR01	IN2005	0.276	7.00mm	8mm Cylindrical	46.00mm	56.00mm	94.00mm
DR0710042TOR01	IN2005	0.280	7.10mm	8mm Cylindrical	45.00mm	56.00mm	94.00mm
DR0720042TOR01	IN2005	0.284	7.20mm	8mm Cylindrical	45.00mm	56.00mm	94.00mm
DR0730042TOR01	IN2005	0.287	7.30mm	8mm Cylindrical	45.00mm	56.00mm	94.00mm
DR0740042TOR01	IN2005	0.291	7.40mm	8mm Cylindrical	45.00mm	56.00mm	94.00mm
DR0750042TOR01	IN2005	0.295	7.50mm	8mm Cylindrical	45.00mm	56.00mm	94.00mm
DR0760042TOR01	IN2005	0.299	7.60mm	8mm Cylindrical	45.00mm	56.00mm	94.00mm
DR0770041TOR01	IN2005	0.303	7.70mm	8mm Cylindrical	44.00mm	56.00mm	94.00mm
DR0780041TOR01	IN2005	0.307	7.80mm	8mm Cylindrical	44.00mm	56.00mm	94.00mm
DR0790041TOR01	IN2005	0.311	7.90mm	8mm Cylindrical	44.00mm	56.00mm	94.00mm
DR0800041TOR01	IN2005	0.315	8.00mm	8mm Cylindrical	44.00mm	56.00mm	94.00mm
DR0810049T1R01	IN2005	0.319	8.10mm	10mm Cylindrical	53.00mm	65.00mm	107.00mm
DR0820049T1R01	IN2005	0.323	8.20mm	10mm Cylindrical	53.00mm	65.00mm	107.00mm
DR0830049T1R01	IN2005	0.327	8.30mm	10mm Cylindrical	53.00mm	65.00mm	107.00mm
DR0840048T1R01	IN2005	0.331	8.40mm	10mm Cylindrical	52.00mm	65.00mm	107.00mm
DR0850048T1R01	IN2005	0.335	8.50mm	10mm Cylindrical	52.00mm	65.00mm	107.00mm
DR0860048T1R01	IN2005	0.339	8.60mm	10mm Cylindrical	52.00mm	65.00mm	107.00mm
DR0870048T1R01	IN2005	0.343	8.70mm	10mm Cylindrical	52.00mm	65.00mm	107.00mm
DR0880048T1R01	IN2005	0.347	8.80mm	10mm Cylindrical	52.00mm	65.00mm	107.00mm
DR0890048T1R01	IN2005	0.350	8.90mm	10mm Cylindrical	52.00mm	65.00mm	107.00mm
DR0900048T1R01	IN2005	0.354	9.00mm	10mm Cylindrical	52.00mm	65.00mm	107.00mm
DR0910047T1R01	IN2005	0.358	9.10mm	10mm Cylindrical	51.00mm	65.00mm	107.00mm
DR0920047T1R01	IN2005	0.362	9.20mm	10mm Cylindrical	51.00mm	65.00mm	107.00mm
DR0930047T1R01	IN2005	0.366	9.30mm	10mm Cylindrical	51.00mm	65.00mm	107.00mm
DR0940047T1R01	IN2005	0.370	9.40mm	10mm Cylindrical	51.00mm	65.00mm	107.00mm
DR0950047T1R01	IN2005	0.374	9.50mm	10mm Cylindrical	51.00mm	65.00mm	107.00mm
DR0960047T1R01	IN2005	0.378	9.60mm	10mm Cylindrical	51.00mm	65.00mm	107.00mm
DR0970046T1R01	IN2005	0.382	9.70mm	10mm Cylindrical	50.00mm	65.00mm	107.00mm
DR0980046T1R01	IN2005	0.386	9.80mm	10mm Cylindrical	50.00mm	65.00mm	107.00mm
DR0990046T1R01	IN2005	0.390	9.90mm	10mm Cylindrical	50.00mm	65.00mm	107.00mm
DR1000046T1R01	IN2005	0.394	10.00mm	10mm Cylindrical	50.00mm	65.00mm	107.00mm
DR1010056T2R01	IN2005	0.398	10.10mm	12mm Cylindrical	63.00mm	78.00mm	125.00mm
DR1020056T2R01	IN2005	0.402	10.20mm	12mm Cylindrical	63.00mm	78.00mm	125.00mm
DR1030056T2R01	IN2005	0.406	10.30mm	12mm Cylindrical	63.00mm	78.00mm	125.00mm
DR1040055T2R01	IN2005	0.409	10.40mm	12mm Cylindrical	62.00mm	78.00mm	125.00mm
DR1050055T2R01	IN2005	0.413	10.50mm	12mm Cylindrical	62.00mm	78.00mm	125.00mm
DR1060055T2R01	IN2005	0.417	10.60mm	12mm Cylindrical	62.00mm	78.00mm	125.00mm
DR1070055T2R01	IN2005	0.421	10.70mm	12mm Cylindrical	62.00mm	78.00mm	125.00mm
DR1080055T2R01	IN2005	0.425	10.80mm	12mm Cylindrical	62.00mm	78.00mm	125.00mm
DR1090055T2R01	IN2005	0.429	10.90mm	12mm Cylindrical	62.00mm	78.00mm	125.00mm



DRILLOIN™ SERIES DR 5:1

SOLID CARBIDE DRILLS

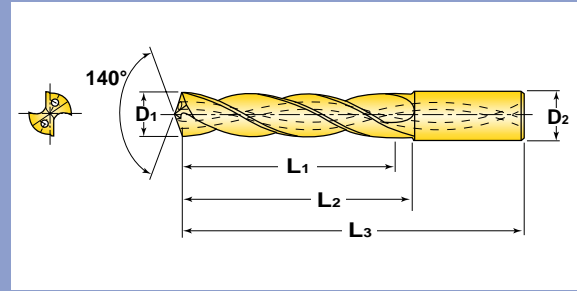

Part Number		D1 Max. Diam. Of Spot (inch)	D1 Max. Diam. Of Spot (mm)	D2 Shank Size/Style	L1 Maximum Depth of Cut	L2 Flute Length	L3 Overall Length
DR1100055T2R01	IN2005	0.433	11.00mm	12mm Cylindrical	62.00mm	78.00mm	125.00mm
DR1110054T2R01	IN2005	0.437	11.10mm	12mm Cylindrical	61.00mm	78.00mm	125.00mm
DR1120054T2R01	IN2005	0.441	11.20mm	12mm Cylindrical	61.00mm	78.00mm	125.00mm
DR1130054T2R01	IN2005	0.445	11.30mm	12mm Cylindrical	61.00mm	78.00mm	125.00mm
DR1140054T2R01	IN2005	0.449	11.40mm	12mm Cylindrical	61.00mm	78.00mm	125.00mm
DR1150054T2R01	IN2005	0.453	11.50mm	12mm Cylindrical	61.00mm	78.00mm	125.00mm
DR1160054T2R01	IN2005	0.457	11.60mm	12mm Cylindrical	61.00mm	78.00mm	125.00mm
DR1170053T2R01	IN2005	0.461	11.70mm	12mm Cylindrical	60.00mm	78.00mm	125.00mm
DR1180053T2R01	IN2005	0.465	11.80mm	12mm Cylindrical	60.00mm	78.00mm	125.00mm
DR1190053T2R01	IN2005	0.469	11.90mm	12mm Cylindrical	60.00mm	78.00mm	125.00mm
DR1200053T2R01	IN2005	0.472	12.00mm	12mm Cylindrical	60.00mm	78.00mm	125.00mm

Operating guidelines on [page 676](#).

SOLID CARBIDE DRILLS

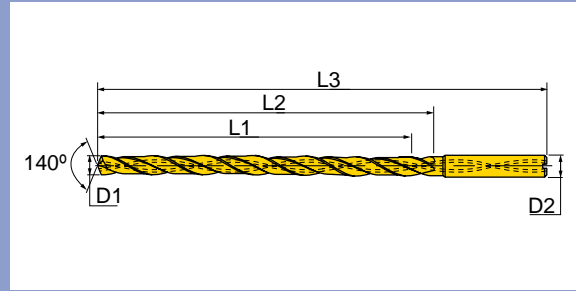

Part Number	D1 Max. Diam. Of Spot	D2 Shank Size/Style	L1 Maximum Depth of Cut	L2 Flute Length	L3 Overall Length
DRXL0500100U1R01	5mm	5mm Cylindrical	115.00mm	50.00mm	165.00mm
DRXL0600120T7R01	6mm	6mm Cylindrical	140.00mm	50.00mm	190.00mm
DRXL0635127R6R01	0.250	.250" Cylindrical	5.79 in	2.00mm	7.75 in
DRXL0700140UAR01	7mm	7mm Cylindrical	160.00mm	50.00mm	210.00mm
DRXL0793158R7R01	0.312	.312" Cylindrical	7.04 in	2.00mm	9.00 in
DRXL0800160TOR01	8mm	8mm Cylindrical	180.00mm	50.00mm	230.00mm
DRXL0900180U9R01	9mm	9mm Cylindrical	205.00mm	60.00mm	265.00mm
DRXL0952190R8R01	0.375	.375" Cylindrical	8.48 in	2.36mm	10.45 in
DRXL1000200T1R01	10mm	10mm Cylindrical	225.00mm	60.00mm	265.00mm

Operating guidelines on [page 676](#).

REPLACEABLE POINT DRILLS



Drilling



Coolant

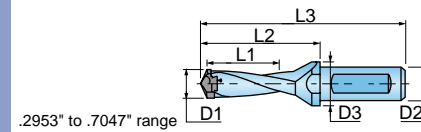

.2953" to .7047" range

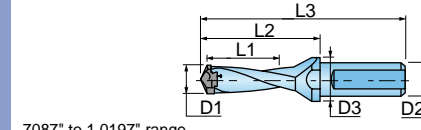

.7087" to 1.0197" range

D1 Nom. Dia. inch	D1 Nom. Dia. mm	Body Number	L1 DOC	L2 Ext.	L3 Overall	D2 Shank Size/Style	D3 Flange Dia.	Pocket Size	Chamfer Ring	Coolant Thru the Point
.2953-.3110	7.5-7.9	YD0750022B9R01	0.87	1.30	3.07	.500" Cyl.	0.63	8	NA	No
.3150-.3307	8.0-8.4	YD0800024B9R01	0.94	1.38	3.15	.500" Cyl.	0.63	8	NA	No
.3346-.3504	8.5-8.9	YD0850025B9R01	0.98	1.46	3.23	.500" Cyl.	0.63	8	NA	No
.3543-.3701	9.0-9.4	YD0900027B9R01	1.06	1.54	3.31	.500" Cyl.	0.63	9	NA	No
.3740-.3898	9.5-9.9	YD0950028B9R01	1.1	1.68	3.45	.500" Cyl.	0.63	9	NA	No
.3937-.4094	10.0-10.4	YD1000030COR01	1.18	1.73	3.62	.625" Cyl.	0.79	10	CB100-01	No
.4134-.4291	10.5-10.9	YD1050031COR01	1.24	1.81	3.7	.625" Cyl.	0.79	10	CB105-01	No
.4331-.4488	11.0-11.4	YD1100033COR01	1.3	1.89	3.78	.625" Cyl.	0.79	11	CB110-01	No
.4528-.4685	11.5-11.9	YD1150034COR01	1.35	1.97	3.86	.625" Cyl.	0.79	11	CB115-01	No
.4724-.4882	12.0-12.4	YD1200036COR01	1.41	2.06	3.95	.625" Cyl.	0.79	12	CB120-01	No
.4912-.5079	12.5-12.9	YD1250037COR01	1.47	2.12	4.01	.625" Cyl.	0.79	12	CB125-01	No
.5118-.5276	13.0-13.4	YD1300039COR01	1.53	2.22	4.11	.625" Cyl.	0.79	13	CB130-01	No
.5315-.5472	13.5-13.9	YD1350040COR01	1.59	2.30	4.19	.625" Cyl.	0.79	13	CB135-01	No
.5512-.5669	14.0-14.4	YD1400042COR01	1.65	2.41	4.3	.625" Cyl.	0.79	14	CB140-01	No
.5709-.5866	14.5-14.9	YD1450043COR01	1.71	2.49	4.38	.625" Cyl.	0.79	14	CB145-01	No
.5906-.6260	15.0-15.9	YD150004518R01	1.77	2.58	4.55	.750" Cyl.	0.98	15	CB150-01	No
.6299-.6654	16.0-16.9	YD160004818R01	1.89	2.75	4.72	.750" Cyl.	0.98	16	CB160-01	No
.6693-.7047	17.0-17.9	YD170005118R01	2.01	2.89	4.86	.750" Cyl.	0.98	17	CB170-01	No
.7087-.7441	18.0-18.9	YD1800054C8R01	2.13	3.08	5.28	1.000" Cyl.	1.26	18	CB180-01	No
.7480-.7835	19.0-19.9	YD1900057C8R01	2.24	3.24	5.44	1.000" Cyl.	1.26	19	CB190-01	No
.7874-.8228	20.0-20.9	YD2000060C8R01	2.36	3.42	5.62	1.000" Cyl.	1.26	20	CB200-01	No
.8268-.8622	21.0-21.9	YD2100063C8R01	2.48	3.57	5.77	1.000" Cyl.	1.26	21	NA	No
.8661-.9016	22.0-22.9	YD2200066C8R01	2.6	3.74	5.94	1.000" Cyl.	1.26	22	NA	Yes
.9055-.9409	23.0-23.9	YD2300069C8R01	2.71	3.92	6.12	1.000" Cyl.	1.26	23	NA	Yes
.9449-.9803	24.0-24.9	YD2400072C8R01	2.83	4.08	6.28	1.000" Cyl.	1.26	24	NA	Yes
.9843-1.0197	25.0-25.9	YD2500075C8R01	2.95	4.29	6.49	1.000" Cyl.	1.26	25	NA	Yes

For Qwik-Twist replaceable tip inserts, see [page 512 - 516](#).

Do not mount a smaller drill point than the D1 range listed for each drill body.

Metric shanks available as non-stock standard.

Operating guidelines on [page 674](#).

HARDWARE



Clamping Key

Optional Torque Key

	Clamping Key	Optional Torque Key
YD0750022B9R01	KDCM-8	TKDCM-8
YD0800024B9R01	KDCM-8	TKDCM-8
YD0850025B9R01	KDCM-8	TKDCM-8
YD0900027B9R01	KDCM-9	TKDCM-9
YD0950028B9R01	KDCM-9	TKDCM-9
YD1000030C0R01	KDCM-10	TKDCM-10
YD1050031C0R01	KDCM-10	TKDCM-10
YD1100033C0R01	KDCM-11	TKDCM-11
YD1150034C0R01	KDCM-11	TKDCM-11
YD1200036C0R01	KDCM-12	TKDCM-12
YD1250037C0R01	KDCM-12	TKDCM-12
YD1300039C0R01	KDCM-13	TKDCM-13
YD1350040C0R01	KDCM-13	TKDCM-13
YD1400042C0R01	KDCM-14	TKDCM-14
YD1450043C0R01	KDCM-14	TKDCM-14
YD150004518R01	KDCM-15	TKDCM-15
YD160004818R01	KDCM-16	TKDCM-16
YD170005118R01	KDCM-17	TKDCM-17
YD1800054C8R01	KDCM-18	TKDCM-18
YD1900057C8R01	KDCM-19	TKDCM-19
YD2000060C8R01	KDCM-20	TKDCM-20
YD2100063C8R01	KDCM-21	TKDCM-21
YD2200066C8R01	KDCM-22	TKDCM-22
YD2300069C8R01	KDCM-23	TKDCM-23
YD2400072C8R01	KDCM-24	TKDCM-24
YD2500075C8R01	KDCM-25	TKDCM-25

REPLACEABLE POINT DRILLS



Drilling



Coolant

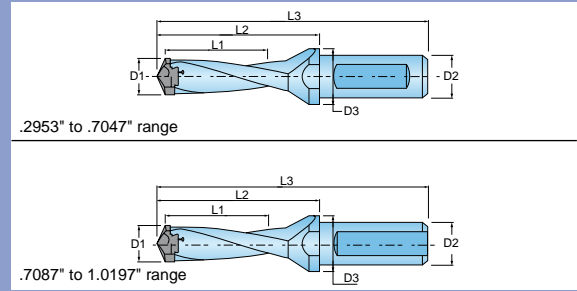

D1 Nom. Dia. inch	D1 Nom. Dia. mm	Body Number	L1 DOC	L2 Ext.	L3 Overall	D2 Shank Size/Style	D3 Flange Dia.	Pocket Size	Chamfer Ring	Coolant Thru the Point
.2953-.3110	7.5-7.9	YD0750037B9R01	1.46	2.01	3.78	.500" Cyl.	0.63	8	NA	No
.3150-.3307	8.0-8.4	YD0800040B9R01	1.57	2.01	3.78	.500" Cyl.	0.63	8	NA	No
.3346-.3504	8.5-8.9	YD0850042B9R01	1.65	2.13	3.9	.500" Cyl.	0.63	8	NA	No
.3543-.3701	9.0-9.4	YD0900045B9R01	1.77	2.25	4.02	.500" Cyl.	0.63	9	NA	No
.3740-.3898	9.5-9.9	YD0950047B9R01	1.85	2.37	4.14	.500" Cyl.	0.63	9	NA	No
.3937-.4094	10.0-10.4	YD1000050C0R01	1.96	2.52	4.41	.625" Cyl.	0.79	10	CB100-01	No
.4134-.4291	10.5-10.9	YD1050052C0R01	2.06	2.64	4.53	.625" Cyl.	0.79	10	CB105-01	No
.4331-.4488	11.0-11.4	YD1100055C0R01	2.16	2.76	4.65	.625" Cyl.	0.79	11	CB110-01	No
.4528-.4685	11.5-11.9	YD1150057C0R01	2.26	2.87	4.76	.625" Cyl.	0.79	11	CB115-01	No
.4724-.4882	12.0-12.4	YD1200060C0R01	2.36	3.00	4.89	.625" Cyl.	0.79	12	CB120-01	No
.4912-.5079	12.5-12.9	YD1250062C0R01	2.46	3.12	5.01	.625" Cyl.	0.79	12	CB125-01	No
.5118-.5276	13.0-13.4	YD1300065C0R01	2.56	3.24	5.13	.625" Cyl.	0.79	13	CB130-01	No
.5315-.5472	13.5-13.9	YD1350067C0R01	2.65	3.36	5.25	.625" Cyl.	0.79	13	CB135-01	No
.5512-.5669	14.0-14.4	YD1400070C0R01	2.75	3.51	5.4	.625" Cyl.	0.79	14	CB140-01	No
.5709-.5866	14.5-14.9	YD1450072C0R01	2.85	3.63	5.52	.625" Cyl.	0.79	14	CB145-01	No
.5906-.6260	15.0-15.9	YD150007518R01	2.95	3.76	5.73	.750" Cyl.	0.98	15	CB150-01	No
.6299-.6654	16.0-16.9	YD160008018R01	3.15	4.01	5.98	.750" Cyl.	0.98	16	CB160-01	No
.6693-.7047	17.0-17.9	YD170008518R01	3.35	4.23	6.2	.750" Cyl.	0.98	17	CB170-01	No
.7087-.7441	18.0-18.9	YD1800090C8R01	3.54	4.50	6.7	1.000" Cyl.	1.26	18	CB180-01	No
.7480-.7835	19.0-19.9	YD1900095C8R01	3.74	4.73	6.93	1.000" Cyl.	1.26	19	CB190-01	No
.7874-.8228	20.0-20.9	YD2000100C8R01	3.94	5.00	7.2	1.000" Cyl.	1.26	20	CB200-01	No
.8268-.8622	21.0-21.9	YD2100105C8R01	4.13	5.23	7.43	1.000" Cyl.	1.26	21	NA	No
.8661-.9016	22.0-22.9	YD2200110C8R01	4.33	5.47	7.67	1.000" Cyl.	1.26	22	NA	Yes
.9055-.9409	23.0-23.9	YD2300115C8R01	4.53	5.72	7.92	1.000" Cyl.	1.26	23	NA	Yes
.9449-.9803	24.0-24.9	YD2400120C8R01	4.72	5.97	8.17	1.000" Cyl.	1.26	24	NA	Yes
.9843-1.0197	25.0-25.9	YD2500125C8R01	4.92	6.26	8.46	1.000" Cyl.	1.26	25	NA	Yes

For Qwik-Twist replaceable tip inserts, see [page 512 - 516](#).

Do not mount a smaller drill point than the D1 range listed for each drill body.

Metric shanks available as non-stock standard.

Operating guidelines on [page 674](#).

HARDWARE



Clamping Key



Optional Torque Key

	Clamping Key	Optional Torque Key
YD0750037B9R01	KDCM-8	TKDCM-8
YD0800040B9R01	KDCM-8	TKDCM-8
YD0850042B9R01	KDCM-8	TKDCM-8
YD0900045B9R01	KDCM-9	TKDCM-9
YD0950047B9R01	KDCM-9	TKDCM-9
YD1000050C0R01	KDCM-10	TKDCM-10
YD1050052C0R01	KDCM-10	TKDCM-10
YD1100055C0R01	KDCM-11	TKDCM-11
YD1150057C0R01	KDCM-11	TKDCM-11
YD1200060C0R01	KDCM-12	TKDCM-12
YD1250062C0R01	KDCM-12	TKDCM-12
YD1300065C0R01	KDCM-13	TKDCM-13
YD1350067C0R01	KDCM-13	TKDCM-13
YD1400070C0R01	KDCM-14	TKDCM-14
YD1450072C0R01	KDCM-14	TKDCM-14
YD150007518R01	KDCM-15	TKDCM-15
YD160008018R01	KDCM-16	TKDCM-16
YD170008518R01	KDCM-17	TKDCM-17
YD1800090C8R01	KDCM-18	TKDCM-18
YD1900095C8R01	KDCM-19	TKDCM-19
YD2000100C8R01	KDCM-20	TKDCM-20
YD2100105C8R01	KDCM-21	TKDCM-21
YD2200110C8R01	KDCM-22	TKDCM-22
YD2300115C8R01	KDCM-23	TKDCM-23
YD2400120C8R01	KDCM-24	TKDCM-24
YD2500125C8R01	KDCM-25	TKDCM-25

REPLACEABLE POINT DRILLS

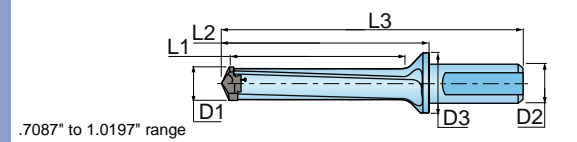
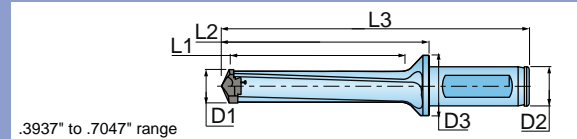

D1 Nom. Dia. inch	D1 Nom. Dia. mm	Body Number	L1 DOC	L2 Ext.	L3 Overall	D2 Shank Dia.	D3 Flange Dia.	Pocket Size
.3937-.4291	10.0-10.9	YD1000080C0R01	3.150	3.700	5.590	0.625	0.790	10
.4331-.4685	11.0-11.9	YD1100088C0R01	3.460	4.060	5.950	0.625	0.790	11
.4724-.5079	12.0-12.9	YD1200096C0R01	3.780	4.420	6.310	0.625	0.790	12
.5118-.5472	13.0-13.9	YD1300104C0R01	4.090	4.780	6.670	0.625	0.790	13
.5512-.5866	14.0-14.9	YD1400112C0R01	4.410	5.170	7.060	0.625	0.790	14
.5906-.6260	15.0-15.9	YD150012018R01	4.720	5.540	7.510	0.750	0.980	15
.6299-.6654	16.0-16.9	YD160012818R01	5.040	5.900	7.870	0.750	0.980	16
.6693-.7047	17.0-17.9	YD170013618R01	5.350	6.240	8.210	0.750	0.980	17
.7087-.7441	18.0-18.9	YD1800144C8R01	5.670	6.620	8.820	1.000	1.260	18
.7480-.7835	19.0-19.9	YD1900152C8R01	5.980	6.980	9.180	1.000	1.260	19
.7874-.8228	20.0-20.9	YD2000160C8R01	6.300	7.370	9.570	1.000	1.260	20
.8268-.8622	21.0-21.9	YD2100168C8R01	6.610	7.720	9.930	1.000	1.260	21
.8661-.9016	22.0-22.9	YD2200176C8R01	6.930	8.070	10.280	1.000	1.260	22
.9055-.9409	23.0-23.9	YD2300184C8R01	7.240	8.460	10.670	1.000	1.260	23
.9449-.9803	24.0-24.9	YD2400192C8R01	7.560	8.830	11.040	1.000	1.260	24
.9843-1.0197	25.0-25.9	YD2500200C8R01	7.870	9.200	11.410	1.000	1.260	25

For Qwik-Twist replaceable tip inserts, see [page 512 - 516](#).

Do not mount a smaller drill point than the D1 range listed for each drill body.

Metric shanks available as non-stock standard.

Operating guidelines on [page 674](#).

HARDWARE



Clamping Key



Optional Torque Key

	Clamping Key	Optional Torque Key
YD1000080C0R01	KDCM-10	TKDCM-10
YD1100088C0R01	KDCM-10	TKDCM-11
YD1200096C0R01	KDCM-12	TKDCM-12
YD1300104C0R01	KDCM-13	TKDCM-13
YD1400112C0R01	KDCM-14	TKDCM-14
YD150012018R01	KDCM-15	TKDCM-15
YD160012818R01	KDCM-16	TKDCM-16
YD170013618R01	KDCM-17	TKDCM-17
YD1800144C8R01	KDCM-18	TKDCM-18
YD1900152C8R01	KDCM-19	TKDCM-19
YD2000160C8R01	KDCM-20	TKDCM-20
YD2100168C8R01	KDCM-21	TKDCM-21
YD2200176C8R01	KDCM-22	TKDCM-22
YD2300184C8R01	KDCM-23	TKDCM-23
YD2400192C8R01	KDCM-24	TKDCM-24
YD2500200C8R01	KDCM-25	TKDCM-25

QWIKOTWIST™ SERIES MHK SLIP-FIT CHAMFER SHANKS

SLIP FIT CHAMFER SHANKS - (STRAIGHT SHANK W/WHISTLE NOTCH FLAT)

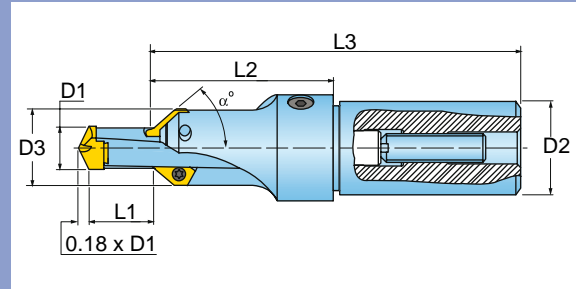

D1 Nom. Dia. inch	D1 Nom. Dia. mm	Chamfer Part Number	Slip Fit Drill Part Number	L1 Adjust Min	L1 Adjust Max	D2 Shank Dia.	D3 Insert Dia.	L2 Ext.	L3 Overall	Chamfer Inserts
.2953-.3110	7.5-7.9	MHK018047DBR01	YD0750026SDR00	0.43	0.81	1.000	0.740	1.87	4.07	GOMT06
.3150-.3307	8.0-8.4	MHK018047DBR01	YD0800028SDR00	0.49	0.85	1.000	0.740	1.87	4.07	GOMT06
.3346-.3504	8.5-8.9	MHK019047DBR01	YD0850029SER00	0.53	0.98	1.000	0.780	1.87	4.07	GOMT06
.3543-.3701	9.0-9.4	MHK019047DBR01	YD0900031SER00	0.55	1.00	1.000	0.780	1.87	4.07	GOMT06
.3740-.3898	9.5-9.9	MHK024067DBR01	YD0950033SFR00	0.61	1.08	1.000	0.980	2.65	4.85	GOMT08
.3937-.4094	10.0-10.4	MHK024067DBR01	YD1000033SFR00	0.49	1.04	1.000	0.980	2.65	4.85	GOMT08
.4134-.4291	10.5-10.9	MHK025067DBR01	YD1050034SGR00	0.49	1.08	1.000	1.020	2.65	4.85	GOMT08
.4331-.4488	11.0-11.4	MHK025067DBR01	YD1100036SGR00	0.63	1.14	1.000	1.020	2.65	4.85	GOMT08
.4528-.4685	11.5-11.9	MHK026067DBR01	YD1150038SHR00	0.53	1.22	1.000	1.060	2.65	4.85	GOMT08
.4724-.4882	12.0-12.4	MHK026067DBR01	YD1200042SHR00	0.67	1.30	1.000	1.060	2.65	4.85	GOMT08
.4921-.5079	12.5-12.9	MHK027067DBR01	YD1250042SJR00	0.67	1.38	1.000	1.100	2.65	4.85	GOMT08
.5118-.5276	13.0-13.4	MHK027067DBR01	YD1300042SJR00	0.75	1.42	1.000	1.100	2.65	4.85	GOMT08
.5315-.5472	13.5-13.9	MHK028067DCR01	YD1350044SKR00	0.67	1.46	1.250	1.120	2.65	5.01	GOMT08
.5512-.5669	14.0-14.4	MHK028067DCR01	YD1400048SKR00	0.75	1.54	1.250	1.120	2.65	5.01	GOMT08
.5709-.5866	14.5-14.9	MHK029067DCR01	YD1450050SLR00	0.69	1.56	1.250	1.160	2.65	5.01	GOMT08
.5906-.6260	15.0-15.9	MHK029067DCR01	YD1500052SLR00	0.89	1.61	1.250	1.160	2.65	5.01	GOMT08
.6299-.6654	16.0-16.9	MHK030067DCR01	YD1600052SMR00	0.93	1.83	1.250	1.200	2.65	5.01	GOMT08
.6693-.7047	17.0-17.9	MHK031067DCR01	YD1700055SNR00	1.00	1.95	1.250	1.240	2.65	5.01	GOMT08
.7087-.7441	18.0-18.9	MHK032067DCR01	YD1800060SPR00	1.10	2.13	1.250	1.280	2.65	5.01	GOMT08
.7480-.7835	19.0-19.9	MHK033075DCR01	YD1900062SQR00	1.30	2.36	1.250	1.310	2.95	5.31	GOMT08
.7874-.8228	20.0-20.9	MHK034075DCR01	YD2000066SRR00	1.42	2.50	1.250	1.350	2.95	5.31	GOMT08

For Qwik-Twist replaceable tip inserts, see [page 512 - 516](#).
 Minimum adjustment is with the smallest drill point diameter in the range.
 Maximum adjustment is with the largest drill point diameter in the range.
 Operating guidelines on [page 677](#).

HARDWARE					
	Screw	Driver	Wrench	Lock Screw	Rear Adj. Screw
MHK018, MHK019	SM25-064-00	DS-T08W	WS-0060	SA060-02	SC060-02

HARDWARE						
	Screw	Driver Blade	Driver Blade	Driver T-Handle	Rear Adj. Screw	Lock Screw
MHK024 and above	SM40-093-20	BLD T15/S7	DS-H05HB	SW6-T	SC100-02	SA100-02

INSERTS

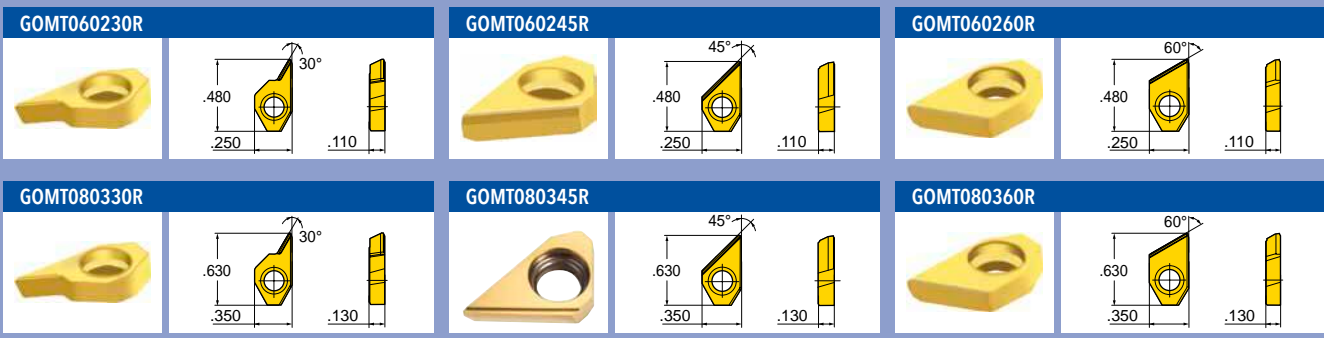

Part Number	Applications	Grade	IN1505										
-------------	--------------	-------	--------	--	--	--	--	--	--	--	--	--	--

GOMT060230R	Chamfering/Multi-Purpose - Chamfer 30 deg.		●										
GOMT060245R	Chamfering/Multi-Purpose - Chamfer		●										
GOMT060260R	Chamfering/Multi-Purpose - Chamfer 60 deg.		●										
GOMT080330R	Chamfering/Multi-Purpose - Chamfer 30 deg.		●										
GOMT080345R	Chamfering/Multi-Purpose - Chamfer		●										
GOMT080360R	Chamfering/Multi-Purpose - Chamfer 60 deg.		●										

● = P ● = M ● = K ● = N ● = S

CHAMFER SHANK INSERT DEPTHS

Chamfer Angle	Part Number	Max. Chamfer Depth	Hole Diameter
30 Degree	GOMT060230R	.06	.295" to .370" (7.5mm to 9.4mm)
45 Degree	GOMT060245R	.18	.295" to .370" (7.5mm to 9.4mm)
60 Degree	GOMT060260R	.10	.295" to .370" (7.5mm to 9.4mm)
30 Degree	GOMT080330R	.06	.374" to .823" (9.5mm to 20.9mm)
45 Degree	GOMT060345R	.24	.374" to .823" (9.5mm to 20.9mm)
60 Degree	GOMT060360R	.14	.374" to .823" (9.5mm to 20.9mm)

QWIKOTWIST™ SERIES Y SLIP-FIT DRILLS 3.5:1

SLIP FIT DRILLS



Drilling



Coolant

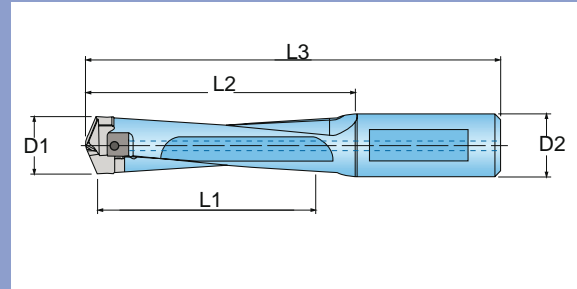

D1 Nom. Dia. inch	D1 Nom. Dia. mm	Body Number	L1 DOC	L2 Ext.	L3 Overall	D2 Shank Dia. mm	D2 Shank Dia. inch	Pocket Size	Optional Chamfer Shank
.2953-.3110	7.5-7.9	YD0750026SDR00	1.020	1.330	3.020	8mm	0.315	8	MHK018047DBR01
.3150-.3307	8.0-8.4	YD0800028SDR00	1.100	1.410	3.110	8mm	0.315	8	MHK018047DBR01
.3346-.3504	8.5-8.9	YD0850029SER00	1.140	1.450	3.150	9mm	0.354	8	MHK019047DBR01
.3543-.3701	9.0-9.4	YD0900031SER00	1.220	1.540	3.230	9mm	0.354	9	MHK019047DBR01
.3740-.3898	9.5-9.9	YD0950033SFR00	1.300	1.590	3.280	10mm	0.394	9	MHK024067DBR01
.3937-.4094	10.0-10.4	YD1000033SFR00	1.300	1.690	3.390	10mm	0.394	10	MHK024067DBR01
.4134-.4291	10.5-10.9	YD1050034SGR00	1.340	1.760	3.460	11mm	0.433	10	MHK025067DBR01
.4331-.4488	11.0-11.4	YD1100036SGR00	1.420	1.850	3.540	11mm	0.433	11	MHK025067DBR01
.4528-.4685	11.5-11.9	YD1150038SHR00	1.500	1.910	3.610	12mm	0.472	11	MHK026067DBR01
.4724-.4882	12.0-12.4	YD1200042SHR00	1.650	2.000	3.690	12mm	0.472	12	MHK026067DBR01
.4921-.5079	12.5-12.9	YD1250042SJR00	1.650	2.070	3.760	13mm	0.512	12	MHK027067DBR01
.5118-.5276	13.0-13.4	YD1300042SJR00	1.650	2.150	3.920	13mm	0.512	13	MHK027067DBR01
.5315-.5472	13.5-13.9	YD1350044SKR00	1.730	2.210	3.980	14mm	0.551	13	MHK028067DCR01
.5512-.5669	14.0-14.4	YD1400048SKR00	1.890	2.330	4.100	14mm	0.551	14	MHK028067DCR01
.5709-.5866	14.5-14.9	YD1450050SLR00	1.970	2.400	4.170	15mm	0.591	14	MHK029067DCR01
.5906-.6260	15.0-15.9	YD1500052SLR00	2.050	2.490	4.260	15mm	0.591	15	MHK029067DCR01
.6299-.6654	16.0-16.9	YD1600052SMR00	2.050	2.640	4.530	16mm	0.630	16	MHK030067DCR01
.6693-.7047	17.0-17.9	YD1700055SNR00	2.170	2.900	4.790	17mm	0.669	17	MHK031067DCR01
.7087-.7441	18.0-18.9	YD1800060SPR00	2.360	3.080	4.970	18mm	0.709	18	MHK032067DCR01
.7480-.7835	19.0-19.9	YD1900062SQR00	2.440	3.220	5.350	19mm	0.748	19	MHK033075DCR01
.7874-.8228	20.0-20.9	YD2000066SRR00	2.600	3.330	5.460	20mm	0.787	20	MHK034075DCR01

For Qwik-Twist replaceable tip inserts, see [page 512 - 516](#).

Do not mount a smaller drill point than the D1 range listed for each drill body.

Operating guidelines on [page 674](#).

HARDWARE



Clamping Key

Optional Torque Key

	Clamping Key	Optional Torque Key
YD0750026SDR00	KDCM-8	TKDCM-8
YD0800028SDR00	KDCM-8	TKDCM-8
YD0850029SER00	KDCM-8	TKDCM-8
YD0900031SER00	KDCM-9	TKDCM-9
YD0950033SFR00	KDCM-9	TKDCM-9
YD1000033SFR00	KDCM-10	TKDCM-10
YD1050034SGR00	KDCM-10	TKDCM-10
YD1100036SGR00	KDCM-11	TKDCM-11
YD1150038SHR00	KDCM-11	TKDCM-11
YD1200042SHR00	KDCM-12	TKDCM-12
YD1250042SJR00	KDCM-12	TKDCM-12
YD1300042SJR00	KDCM-13	TKDCM-13
YD1350044SKR00	KDCM-13	TKDCM-13
YD1400048SKR00	KDCM-14	TKDCM-14
YD1450050SLR00	KDCM-14	TKDCM-14
YD1500052SLR00	KDCM-15	TKDCM-15
YD1600052SMR00	KDCM-16	TKDCM-16
YD1700055SNR00	KDCM-17	TKDCM-17
YD1800060SPR00	KDCM-18	TKDCM-18
YD1900062SQR00	KDCM-19	TKDCM-19
YD2000066SRR00	KDCM-20	TKDCM-20

TAP DRILL/CHAMFER COMBO

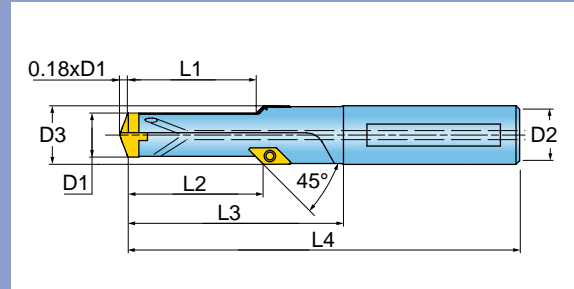

Body Number	Thread Size	D1 Nom. Point Size (inch, mm)	D1 Point Range	L1 Full Dia. to Chamfer	L2 Full Dia. to Top of Chmf.	L3 Ext.	L4 OAL	D2 Shank Dia. (mm, inch)	D3 Chamfer Dia.	Pocket Size
YC0770025RHR01	3/8 UNC	0.311", 7.90mm	.3031-.3110	1.000	1.150	1.800	3.690	15.88mm, 0.625"	0.590	8
YC0820025RHR01	3/8 UNF	0.335", 8.50mm	.3228-.3504	1.000	1.150	1.800	3.690	15.88mm, 0.625"	0.610	8
YC0910026RHR01	7/16 UNC	0.370", 9.40mm	.3583-.3898	1.060	1.200	1.830	3.720	15.88mm, 0.625"	0.630	9
YC0910026RHR01	7/16 UNF	0.390", 9.90mm	.3819-.3898	1.060	1.180	1.820	3.710	15.88mm, 0.625"	0.630	9
YC1050026RHR01	1/2 UNC	0.425", 10.80mm	.4134-.4291	1.060	1.170	1.890	3.780	15.88mm, 0.625"	0.630	10
YC1130026RHR01	1/2 UNF	0.453", 11.50mm	.4449-.4685	1.060	1.150	1.890	3.780	15.88mm, 0.625"	0.630	11
YC1210026RHR01	9/16 UNC	0.484", 12.30mm	.4764-.5079	1.060	1.140	1.890	3.780	15.88mm, 0.625"	0.630	12
YC1300026RHR01	9/16 UNF	0.512", 13.00mm	.5118-.5472	1.060	1.120	1.890	3.780	15.88mm, 0.625"	0.630	13
YC1330030RJ01	5/8 UNC	0.539", 13.70mm	.5236-.5472	1.200	1.320	2.010	3.980	19.05mm, 0.750"	0.750	13
YC1450030RJ01	5/8 UNF	0.575", 14.60mm	.5709-.5866	1.200	1.290	2.030	4.000	19.05mm, 0.750"	0.750	14
YC1650035RJ01	3/4 UNC	0.658", 16.70mm	.6496-.6654	1.400	1.470	2.200	4.170	19.05mm, 0.750"	0.780	16
YC1730035RLR01	3/4 UNF	0.689", 17.50mm	.6811-.7047	1.400	1.500	2.200	4.400	25.40mm, 1.000"	0.880	17
YC1920041RLR01	7/8 UNC	0.768", 19.50mm	.7559-.7835	1.650	1.780	2.480	4.680	25.40mm, 1.000"	1.000	19
YC2040041RLR01	7/8 UNF	0.807", 20.50mm	.8031-.8228	1.650	1.750	2.480	4.680	25.40mm, 1.000"	1.000	20
YC0680021SKR00	M08	0.268", 6.80mm	.2677-.2913	0.827	0.972	1.650	3.420	14.00mm, 0.551"	0.547	6.8
YC0830026SKR00	M10	0.335", 8.50mm	.3268-.3504	1.024	1.138	1.831	3.600	14.00mm, 0.551"	0.551	8
YC1000030SKR00	M12	0.402", 10.20mm	.3937-.4291	1.181	1.264	2.047	3.820	14.00mm, 0.551"	0.551	10
YC1200035SMR00	M14	0.472", 12.00mm	.4724-.5079	1.378	1.465	2.283	4.170	16.00mm, 0.630"	0.630	12
YC1400039SPR00	M16	0.551", 14.00mm	.5512-.5866	1.535	1.622	2.362	4.250	18.00mm, 0.709"	0.709	14
YC1730042SRR00	M20	0.689", 17.50mm	.6811-.7047	1.654	1.728	2.480	4.450	20.00mm, 0.787"	0.827	17
YC2100048SSR00	M24	0.827", 21.00mm	.8268-.8622	1.890	1.984	2.677	4.880	25.00mm, 0.984"	1.004	21

For Qwik-Twist replaceable tip inserts, see [page 512 - 516](#).
Operating guidelines on [page 674](#).

INSERTS

KOMT050104R





Part Number	Applications	Grade	IN2005							
-------------	--------------	-------	--------	--	--	--	--	--	--	--

KOMT050104R Chamfering/Multi-Purpose - Chamfer 

○ = P
 ○ = M
 ○ = K
 ○ = N
 ○ = S

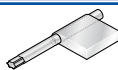
HARDWARE



	Screw	Driver	Clamping Key
YC0770025RHR01	SM22-046-00	DS-T07F	KDCM-8
YC0820025RHR01	SM22-046-00	DS-T07F	KDCM-8
YC0910026RHR01	SM22-046-00	DS-T07F	KDCM-9
YC0910026RHR01	SM22-046-00	DS-T07F	KDCM-9
YC1050026RHR01	SM22-046-00	DS-T07F	KDCM-10
YC1130026RHR01	SM22-046-00	DS-T07F	KDCM-11
YC1210026RHR01	SM22-046-00	DS-T07F	KDCM-12
YC1300026RHR01	SM22-046-00	DS-T07F	KDCM-13
YC1330030JR01	SM22-046-00	DS-T07F	KDCM-13
YC1450030JR01	SM22-046-00	DS-T07F	KDCM-14
YC1650035JR01	SM22-046-00	DS-T07F	KDCM-16
YC1730035RLR01	SM22-046-00	DS-T07F	KDCM-17
YC1920041RLR01	SM22-046-00	DS-T07F	KDCM-19
YC2040041RLR01	SM22-046-00	DS-T07F	KDCM-20
YC0680021SKR00	SM22-046-00	DS-T07F	KDCM-8
YC0830026SKR00	SM22-046-00	DS-T07F	KDCM-8
YC1000030SKR00	SM22-046-00	DS-T07F	KDCM-10
YC1200035SMR00	SM22-046-00	DS-T07F	KDCM-12
YC1400039SPR00	SM22-046-00	DS-T07F	KDCM-14
YC1730042SRR00	SM22-046-00	DS-T07F	KDCM-17
YC2100048SSR00	SM22-046-00	DS-T07F	KDCM-21

QWIKOTWIST™ SERIES CB CHAMFER RINGS

CHAMFER RINGS - COMBINE DRILLING & CHAMFERING IN ONE OPERATION.

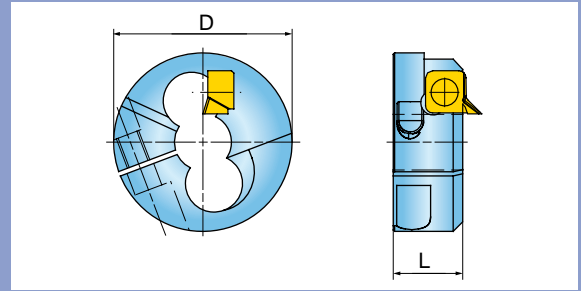

Part Number	A Fits Qwik-Twist Drill Series	Maximum Chamfer Size	D Diameter	H Height
CB100-01	YD1000	.06" x 45 deg	1.26	0.56
CB105-01	YD1050	.06" x 45 deg	1.26	0.56
CB110-01	YD1100	.06" x 45 deg	1.38	0.57
CB115-01	YD1150	.06" x 45 deg	1.38	0.57
CB120-01	YD1200	.06" x 45 deg	1.48	0.57
CB125-01	YD1250	.06" x 45 deg	1.48	0.57
CB130-01	YD1300	.06" x 45 deg	1.54	0.57
CB135-01	YD1350	.06" x 45 deg	1.54	0.57
CB140-01	YD1400	.06" x 45 deg	1.61	0.60
CB145-01	YD1450	.06" x 45 deg	1.61	0.60
CB150-01	YD1500	.06" x 45 deg	1.69	0.65
CB160-01	YD1600	.08" x 45 deg	1.77	0.67
CB170-01	YD1700	.08" x 45 deg	1.85	0.69
CB180-01	YD1800	.08" x 45 deg	1.89	0.71
CB190-01	YD1900	.08" x 45 deg	1.97	0.71
CB200-01	YD2000	.08" x 45 deg	2.05	0.71

Chamfer rings for use with 3:1 and 5:1 Qwik-Twist bodies on [pages 504](#) and [508](#). Operating guidelines on [page 682](#).

INSERTS

ZOMW090700R



Part Number	Applications	Grade	IN1530						
-------------	--------------	-------	--------	--	--	--	--	--	--

ZOMW090700R Chamfering/Multi-Purpose - Chamfer 

○ = P
 ○ = M
 ○ = K
 ○ = N
 ○ = S

HARDWARE



	Screw	Driver T-Handle	Clamp Screw Driver Blade	Cap Screw	Insert Driver Blade
CB100-01	SM40-093-20	SW6-T	BLDT25/S7	SD050-A5	BLD T15/S7
CB105-01	SM40-093-20	SW6-T	BLDT25/S7	SD050-A5	BLD T15/S7
CB110-01	SM40-093-20	SW6-T	BLDT25/S7	SD050-A5	BLD T15/S7
CB115-01	SM40-093-20	SW6-T	BLDT25/S7	SD050-A5	BLD T15/S7
CB120-01	SM40-093-20	SW6-T	BLDT25/S7	SD050-A5	BLD T15/S7
CB125-01	SM40-093-20	SW6-T	BLDT25/S7	SD050-A5	BLD T15/S7
CB130-01	SM40-093-20	SW6-T	BLDT25/S7	SD050-A5	BLD T15/S7
CB135-01	SM40-093-20	SW6-T	BLDT25/S7	SD050-A5	BLD T15/S7
CB140-01	SM40-093-20	SW6-T	BLDT25/S7	SD050-A5	BLD T15/S7
CB145-01	SM40-093-20	SW6-T	BLDT25/S7	SD050-A5	BLD T15/S7
CB150-01	SM40-093-20	SW6-T	BLDT25/S7	SD050-A5	BLD T15/S7
CB160-01	SM40-093-20	SW6-T	DS-H05HB	SD060-20	BLD T15/S7
CB170-01	SM40-093-20	SW6-T	DS-H05HB	SD060-20	BLD T15/S7
CB180-01	SM40-093-20	SW6-T	DS-H05HB	SD060-20	BLD T15/S7
CB190-01	SM40-093-20	SW6-T	DS-H05HB	SD060-20	BLD T15/S7
CB200-01	SM40-093-20	SW6-T	DS-H05HB	SD060-20	BLD T15/S7

DRILL POINTS - .2677" TO .4291"

General Purpose

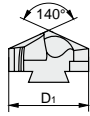

Cast Iron

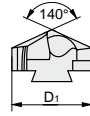

D1 Drill Diameter		General Purpose Part Number	Cast Iron* Part Number	Pocket Size	GRADE	2005
inch	mm					
.2677	6,8	YAB0680R01	YBB0680R01	6, 8		
.2953	7,5	YAB0750R01	YBB0750R01	8		
.2992	7,6	YAB0760R01	YBB0760R01	8		
.3031	7,7	YAB0770R01	YBB0770R01	8		
.3071	7,8	YAB0780R01	YBB0780R01	8		
.3110	7,9	YAB0790R01	YBB0790R01	8		
.3150	8,0	YAB0800R01	YBB0800R01	8		
.3189	8,1	YAB0810R01	YBB0810R01	8		
.3228	8,2	YAB0820R01	YBB0820R01	8		
.3268	8,3	YAB0830R01	YBB0830R01	8		
.3307	8,4	YAB0840R01	YBB0840R01	8		
.3346	8,5	YAB0850R01	YBB0850R01	8		
.3386	8,6	YAB0860R01	YBB0860R01	8		
.3425	8,7	YAB0870R01	YBB0870R01	8		
.3465	8,8	YAB0880R01	YBB0880R01	8		
.3504	8,9	YAB0890R01	YBB0890R01	8		
.3543	9,0	YAB0900R01	YBB0900R01	9		
.3583	9,1	YAB0910R01	YBB0910R01	9		
.3622	9,2	YAB0920R01	YBB0920R01	9		
.3661	9,3	YAB0930R01	YBB0930R01	9		
.3701	9,4	YAB0940R01	YBB0940R01	9		
.3740	9,5	YAB0950R01	YBB0950R01	9		
.3780	9,6	YAB0960R01	YBB0960R01	9		
.3819	9,7	YAB0970R01	YBB0970R01	9		
.3858	9,8	YAB0980R01	YBB0980R01	9		
.3898	9,9	YAB0990R01	YBB0990R01	9		
.3937	10,0	YAB1000R01	YBB1000R01	10		
.3976	10,1	YAB1010R01	YBB1010R01	10		
.4016	10,2	YAB1020R01	YBB1020R01	10		
.4055	10,3	YAB1030R01	YBB1030R01	10		
.4094	10,4	YAB1040R01	YBB1040R01	10		
.4134	10,5	YAB1050R01	YBB1050R01	10		
.4173	10,6	YAB1060R01	YBB1060R01	10		
.4213	10,7	YAB1070R01	YBB1070R01	10		
.4252	10,8	YAB1080R01	YBB1080R01	10		
.4291	10,9	YAB1090R01	YBB1090R01	10		

*Cast iron point also effective in reducing burrs and breakout in steel applications.

● = P ● = M ● = K ● = N ● = S

QWIKOTWIST™ SERIES Y REPLACEABLE DRILL POINTS

DRILL POINTS - .4331" TO .5866"

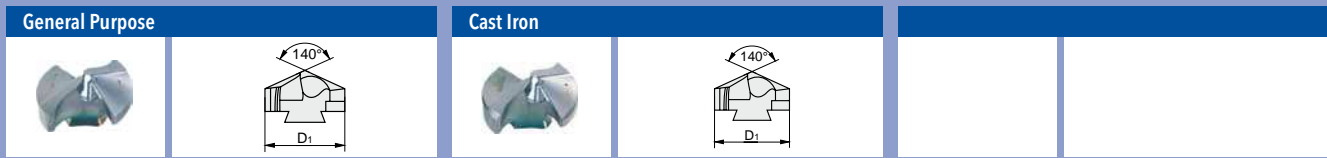

D1 Drill Diameter		General Purpose Part Number	Cast Iron* Part Number	Pocket Size	GRADE 2005
inch	mm				
.4331	11,0	YAB1100R01	YBB1100R01	11	
.4370	11,1	YAB1110R01	YBB1110R01	11	
.4409	11,2	YAB1120R01	YBB1120R01	11	
.4449	11,3	YAB1130R01	YBB1130R01	11	
.4488	11,4	YAB1140R01	YBB1140R01	11	
.4528	11,5	YAB1150R01	YBB1150R01	11	
.4567	11,6	YAB1160R01	YBB1160R01	11	
.4606	11,7	YAB1170R01	YBB1170R01	11	
.4646	11,8	YAB1180R01	YBB1180R01	11	
.4685	11,9	YAB1190R01	YBB1190R01	11	
.4724	12,0	YAB1200R01	YBB1200R01	12	
.4764	12,1	YAB1210R01	YBB1210R01	12	
.4803	12,2	YAB1220R01	YBB1220R01	12	
.4843	12,3	YAB1230R01	YBB1230R01	12	
.4882	12,4	YAB1240R01	YBB1240R01	12	
.4921	12,5	YAB1250R01	YBB1250R01	12	
.4961	12,6	YAB1260R01	YBB1260R01	12	
.5000	12,7	YAB1270R01	YBB1270R01	12	
.5039	12,8	YAB1280R01	YBB1280R01	12	
.5079	12,9	YAB1290R01	YBB1290R01	12	
.5118	13,0	YAB1300R01	YBB1300R01	13	
.5157	13,1	YAB1310R01	YBB1310R01	13	
.5197	13,2	YAB1320R01	YBB1320R01	13	
.5236	13,3	YAB1330R01	YBB1330R01	13	
.5276	13,4	YAB1340R01	YBB1340R01	13	
.5315	13,5	YAB1350R01	YBB1350R01	13	
.5354	13,6	YAB1360R01	YBB1360R01	13	
.5394	13,7	YAB1370R01	YBB1370R01	13	
.5433	13,8	YAB1380R01	YBB1380R01	13	
.5472	13,9	YAB1390R01	YBB1390R01	13	
.5512	14,0	YAB1400R01	YBB1400R01	14	
.5551	14,1	YAB1410R01	YBB1410R01	14	
.5591	14,2	YAB1420R01	YBB1420R01	14	
.5630	14,3	YAB1430R01	YBB1430R01	14	
.5669	14,4	YAB1440R01	YBB1440R01	14	
.5709	14,5	YAB1450R01	YBB1450R01	14	
.5748	14,6	YAB1460R01	YBB1460R01	14	
.5787	14,7	YAB1470R01	YBB1470R01	14	
.5827	14,8	YAB1480R01	YBB1480R01	14	
.5866	14,9	YAB1490R01	YBB1490R01	14	

*Cast iron point also effective in reducing burrs and breakout in steel applications.

○ = P ● = M ● = K ● = N ● = S

DRILL POINTS - .5906" TO .7441"

General Purpose

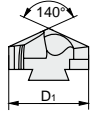

Cast Iron

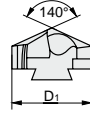

D1 Drill Diameter		General Purpose Part Number	Cast Iron* Part Number	Pocket Size	GRADE 2005
inch	mm				
.5906	15,0	YAB1500R01	YBB1500R01	15	
.5945	15,1	YAB1510R01	YBB1510R01	15	
.5984	15,2	YAB1520R01	YBB1520R01	15	
.6024	15,3	YAB1530R01	YBB1530R01	15	
.6063	15,4	YAB1540R01	YBB1540R01	15	
.6102	15,5	YAB1550R01	YBB1550R01	15	
.6142	15,6	YAB1560R01	YBB1560R01	15	
.6181	15,7	YAB1570R01	YBB1570R01	15	
.6220	15,8	YAB1580R01	YBB1580R01	15	
.6260	15,9	YAB1590R01	YBB1590R01	15	
.6299	16,0	YAB1600R01	YBB1600R01	16	
.6339	16,1	YAB1610R01	YBB1610R01	16	
.6378	16,2	YAB1620R01	YBB1620R01	16	
.6417	16,3	YAB1630R01	YBB1630R01	16	
.6457	16,4	YAB1640R01	YBB1640R01	16	
.6496	16,5	YAB1650R01	YBB1650R01	16	
.6535	16,6	YAB1660R01	YBB1660R01	16	
.6575	16,7	YAB1670R01	YBB1670R01	16	
.6614	16,8	YAB1680R01	YBB1680R01	16	
.6654	16,9	YAB1690R01	YBB1690R01	16	
.6693	17,0	YAB1700R01	YBB1700R01	17	
.6732	17,1	YAB1710R01	YBB1710R01	17	
.6772	17,2	YAB1720R01	YBB1720R01	17	
.6811	17,3	YAB1730R01	YBB1730R01	17	
.6850	17,4	YAB1740R01	YBB1740R01	17	
.6890	17,5	YAB1750R01	YBB1750R01	17	
.6929	17,6	YAB1760R01	YBB1760R01	17	
.6968	17,7	YAB1770R01	YBB1770R01	17	
.7008	17,8	YAB1780R01	YBB1780R01	17	
.7047	17,9	YAB1790R01	YBB1790R01	17	
.7087	18,0	YAB1800R01	YBB1800R01	18	
.7126	18,1	YAB1810R01	YBB1810R01	18	
.7165	18,2	YAB1820R01	YBB1820R01	18	
.7205	18,3	YAB1830R01	YBB1830R01	18	
.7244	18,4	YAB1840R01	YBB1840R01	18	
.7283	18,5	YAB1850R01	YBB1850R01	18	
.7323	18,6	YAB1860R01	YBB1860R01	18	
.7362	18,7	YAB1870R01	YBB1870R01	18	
.7402	18,8	YAB1880R01	YBB1880R01	18	
.7441	18,9	YAB1890R01	YBB1890R01	18	
.7480	19,0	YAB1900R01	YBB1900R01	19	

*Cast iron point also effective in reducing burrs and breakout in steel applications.

○ = P ● = M ● = K ● = N ● = S

QWIKOTWIST™ SERIES Y REPLACEABLE DRILL POINTS

DRILL POINTS - .7500" TO .8976"

General Purpose

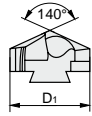

Cast Iron

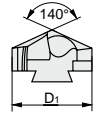

D1 Drill Diameter		General Purpose Part Number	Cast Iron* Part Number	Pocket Size	GRADE 2005
inch	mm				
.7500	19,05	YAB1905R01	YBB1905R01	19	●●●●●
.7520	19,1	YAB1910R01	YBB1910R01	19	●●●●●
.7559	19,2	YAB1920R01	YBB1920R01	19	●●●●●
.7598	19,3	YAB1930R01	YBB1930R01	19	●●●●●
.7638	19,4	YAB1940R01	YBB1940R01	19	●●●●●
.7677	19,5	YAB1950R01	YBB1950R01	19	●●●●●
.7717	19,6	YAB1960R01	YBB1960R01	19	●●●●●
.7756	19,7	YAB1970R01	YBB1970R01	19	●●●●●
.7795	19,8	YAB1980R01	YBB1980R01	19	●●●●●
.7835	19,9	YAB1990R01	YBB1990R01	19	●●●●●
.7874	20,0	YAB2000R01	YBB2000R01	20	●●●●●
.7913	20,1	YAB2010R01	YBB2010R01	20	●●●●●
.7953	20,2	YAB2020R01	YBB2020R01	20	●●●●●
.7992	20,3	YAB2030R01	YBB2030R01	20	●●●●●
.8031	20,4	YAB2040R01	YBB2040R01	20	●●●●●
.8071	20,5	YAB2050R01	YBB2050R01	20	●●●●●
.8110	20,6	YAB2060R01	YBB2060R01	20	●●●●●
.8150	20,7	YAB2070R01	YBB2070R01	20	●●●●●
.8189	20,8	YAB2080R01	YBB2080R01	20	●●●●●
.8228	20,9	YAB2090R01	YBB2090R01	20	●●●●●
.8268	21,0	YAB2100R01	YBB2100R01	21	●●●●●
.8307	21,1	YAB2110R01	YBB2110R01	21	●●●●●
.8346	21,2	YAB2120R01	YBB2120R01	21	●●●●●
.8386	21,3	YAB2130R01	YBB2130R01	21	●●●●●
.8425	21,4	YAB2140R01	YBB2140R01	21	●●●●●
.8465	21,5	YAB2150R01	YBB2150R01	21	●●●●●
.8504	21,6	YAB2160R01	YBB2160R01	21	●●●●●
.8543	21,7	YAB2170R01	YBB2170R01	21	●●●●●
.8583	21,8	YAB2180R01	YBB2180R01	21	●●●●●
.8622	21,9	YAB2190R01	YBB2190R01	21	●●●●●
.8661	22,0	YAB2200R01	YBB2200R01	22	●●●●●
.8701	22,1	YAB2210R01	YBB2210R01	22	●●●●●
.8740	22,2	YAB2220R01	YBB2220R01	22	●●●●●
.8750	22,22	YAB2222R01	YBB2222R01	22	●●●●●
.8780	22,3	YAB2230R01	YBB2230R01	22	●●●●●
.8819	22,4	YAB2240R01	YBB2240R01	22	●●●●●
.8858	22,5	YAB2250R01	YBB2250R01	22	●●●●●
.8898	22,6	YAB2260R01	YBB2260R01	22	●●●●●
.8937	22,7	YAB2270R01	YBB2270R01	22	●●●●●
.8976	22,8	YAB2280R01	YBB2280R01	22	●●●●●

*Cast iron point also effective in reducing burrs and breakout in steel applications.

● = P ● = M ● = K ● = N ● = S

DRILL POINTS - .9016" TO 1.0197"

General Purpose

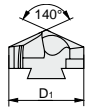

Cast Iron

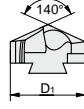

D1 Drill Diameter		General Purpose Part Number	Cast Iron* Part Number	Pocket Size	GRADE	2005
inch	mm					
.9016	22,9	YAB2290R01	YBB2290R01	22		
.9055	23,0	YAB2300R01	YBB2300R01	23		
.9094	23,1	YAB2310R01	YBB2310R01	23		
.9134	23,2	YAB2320R01	YBB2320R01	23		
.9173	23,3	YAB2330R01	YBB2330R01	23		
.9213	23,4	YAB2340R01	YBB2340R01	23		
.9252	23,5	YAB2350R01	YBB2350R01	23		
.9291	23,6	YAB2360R01	YBB2360R01	23		
.9331	23,7	YAB2370R01	YBB2370R01	23		
.9370	23,8	YAB2380R01	YBB2380R01	23		
.9409	23,9	YAB2390R01	YBB2390R01	23		
.9449	24,0	YAB2400R01	YBB2400R01	24		
.9488	24,1	YAB2410R01	YBB2410R01	24		
.9528	24,2	YAB2420R01	YBB2420R01	24		
.9567	24,3	YAB2430R01	YBB2430R01	24		
.9606	24,4	YAB2440R01	YBB2440R01	24		
.9646	24,5	YAB2450R01	YBB2450R01	24		
.9685	24,6	YAB2460R01	YBB2460R01	24		
.9724	24,7	YAB2470R01	YBB2470R01	24		
.9764	24,8	YAB2480R01	YBB2480R01	24		
.9803	24,9	YAB2490R01	YBB2490R01	24		
.9843	25,0	YAB2500R01	YBB2500R01	25		
.9882	25,1	YAB2510R01	YBB2510R01	25		
.9921	25,2	YAB2520R01	YBB2520R01	25		
.9961	25,3	YAB2530R01	YBB2530R01	25		
1.0000	25,4	YAB2540R01	YBB2540R01	25		
1.0039	25,5	YAB2550R01	YBB2550R01	25		
1.0079	25,6	YAB2560R01	YBB2560R01	25		
1.0118	25,7	YAB2570R01	YBB2570R01	25		
1.0157	25,8	YAB2580R01	YBB2580R01	25		
1.0197	25,9	YAB2590R01	YBB2590R01	25		

*Cast iron point also effective in reducing burrs and breakout in steel applications.

○ = P ○ = M ○ = K ○ = N ○ = S

TKDCM SERIES



Key Part Number	Drill Pocket Size	Minimal Clamping Torque (in-lb)
TKDCM-8	8	1.3 - 1.8
TKDCM-9	9	1.3 - 1.8
TKDCM-10	10	1.9 - 2.1
TKDCM-11	11	1.9 - 2.1
TKDCM-12	12	1.9 - 2.1
TKDCM-13	13	1.9 - 2.1
TKDCM-14	14	1.9 - 2.1
TKDCM-15	15	1.9 - 2.1
TKDCM-16	16	1.9 - 2.1
TKDCM-17	17	2.3 - 2.6
TKDCM-18	18	2.3 - 2.6
TKDCM-19	19	2.3 - 2.6
TKDCM-20	20	2.3 - 2.6
TKDCM-21	21	2.7 - 3.1
TKDCM-22	22	2.7 - 3.1
TKDCM-23	23	2.7 - 3.1
TKDCM-24	24	2.7 - 3.1
TKDCM-25	25	2.7 - 3.1

The number of drill point indexes is dependent on machine rigidity, workpiece stability and clamping, machining parameters, workpiece configuration, material coolant, coolant pressure and proper drill application.

It is recommended to use the torque key for inspection purposes only, not as a substitute for the standard key provided with each drill body.

Torque keys are available for checking minimal clamping torque. If a "click" is not heard or felt while slowly unclamping with the torque key, the drill must be replaced.

TYPICAL UNLOCKING TORQUE RANGE

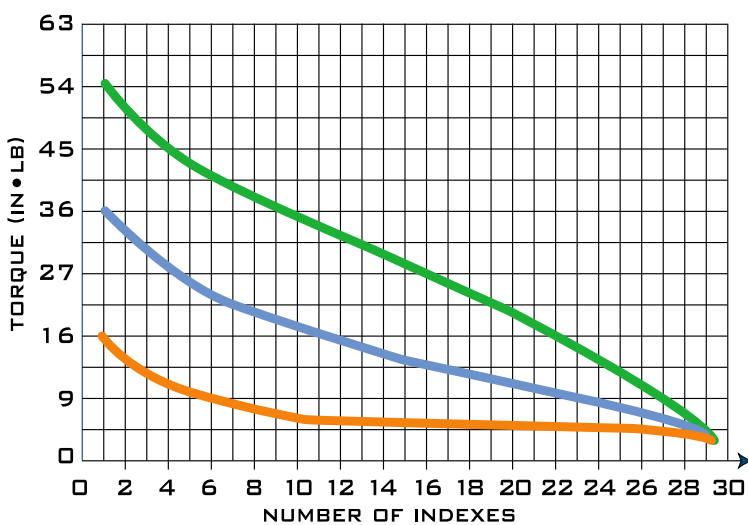

DIA=.669 - 1.020

DIA=.433 - .665

DIA=.295 - .429

SQUARE INSERT INDEXABLE DRILLS

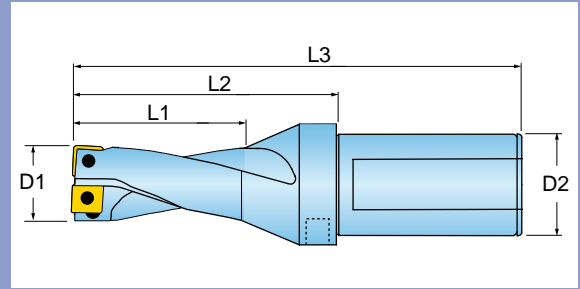

Part Number	D1 Nom. Dia. inch	D1 Nom. Dia. mm	L1 Drilling Length	L2 Ext. frm Holder	L3 Overall Length	D2 Shank Style/Size	Num of Inserts
Q0127025N5R01	0.500	12.7mm	1.00	2.05	4.25	1.000 Universal	2
Q0135027N5R01	0.531	13.5mm	1.06	2.13	4.33	1.000 Universal	2
Q0143029N5R01	0.563	14.3mm	1.13	2.13	4.33	1.000 Universal	2
Q0150030N5R01	0.594	15.0mm	1.19	2.24	4.44	1.000 Universal	2
Q0159032N5R01	0.625	15.9mm	1.25	2.36	4.57	1.000 Universal	2
Q0167033N5R01	0.657	16.7mm	1.31	2.44	4.65	1.000 Universal	2
Q0175035N5R01	0.688	17.5mm	1.38	2.56	4.76	1.000 Universal	2
Q0183037N5R01	0.719	18.3mm	1.44	2.56	4.76	1.000 Universal	2
Q0191038N5R01	0.750	19.0mm	1.50	2.64	4.84	1.000 Universal	2
Q0198040N5R01	0.781	19.8mm	1.56	2.80	5.00	1.000 Universal	2
Q0206041N5R01	0.813	20.6mm	1.63	2.87	5.08	1.000 Universal	2
Q0214042N5R02	0.843	21.4mm	1.69	2.95	5.16	1.000 Universal	2
Q0222044N5R02	0.875	22.2mm	1.75	2.95	5.16	1.000 Universal	2
Q0230046N6R01	0.906	23.0mm	1.81	3.19	5.55	1.250 Universal	2
Q0238048N6R01	0.938	23.8mm	1.88	3.31	5.67	1.250 Universal	2
Q0246049N6R01	0.969	24.6mm	1.94	3.43	5.79	1.250 Universal	2
Q0250050N6R01	0.984	25.0mm	1.97	3.07	5.35	1.250 Universal	2
Q0254051N6R01	1.000	25.4mm	2.00	3.50	5.87	1.250 Universal	2
Q0262052N6R01	1.031	26.2mm	2.06	3.50	5.87	1.250 Universal	2
Q0270054N6R01	1.063	27.0mm	2.13	3.58	5.94	1.250 Universal	2
Q0278056N6R02	1.094	27.8mm	2.19	3.70	6.06	1.250 Universal	2
Q0286057N6R02	1.125	28.6mm	2.25	3.78	6.14	1.250 Universal	2
Q0294059N6R01	1.156	29.4mm	2.31	3.98	6.34	1.250 Universal	2
Q0302060N6R01	1.187	30.2mm	2.37	3.98	6.34	1.250 Universal	2
Q0310062N6R01	1.219	31.0mm	2.44	4.09	6.45	1.250 Universal	2
Q0318063N6R01	1.250	31.7mm	2.50	4.17	6.53	1.250 Universal	2
Q0325065N6R01	1.281	32.5mm	2.56	4.29	6.65	1.250 Universal	2
Q0333067N6R01	1.312	33.3mm	2.62	4.29	6.65	1.250 Universal	2
Q0341068N6R02	1.343	34.1mm	2.69	4.37	6.73	1.250 Universal	2
Q0349070N6R02	1.375	34.9mm	2.75	4.49	6.85	1.250 Universal	2
Q0357071N6R02	1.406	35.7mm	2.81	4.61	6.97	1.250 Universal	2
Q0365073N6R01	1.437	36.5mm	2.87	4.72	7.08	1.250 Universal	2
Q0373075N6R01	1.468	37.3mm	2.94	4.72	7.08	1.250 Universal	2
Q0381076N6R01	1.500	38.1mm	3.00	4.84	7.20	1.250 Universal	2
Q0389078N6R01	1.531	38.9mm	3.06	4.92	7.28	1.250 Universal	2
Q0397079N6R01	1.562	39.7mm	3.12	5.04	7.40	1.250 Universal	2
Q0405081N6R01	1.594	40.5mm	3.19	5.16	7.52	1.250 Universal	2
Q0413083N6R01	1.625	41.3mm	3.25	5.16	7.52	1.250 Universal	2
Q0428086N6R02	1.687	42.8mm	3.37	5.35	7.71	1.250 Universal	2

SQUARE INSERT INDEXABLE DRILLS

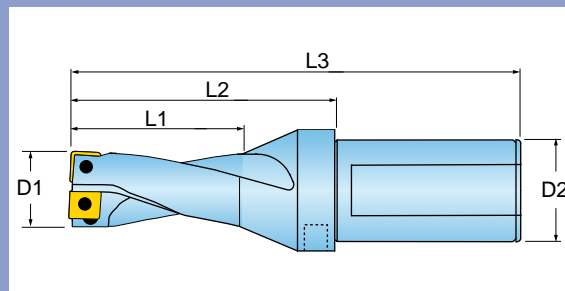

Part Number	D1 Nom. Dia. inch	D1 Nom. Dia. mm	L1 Drilling Length	L2 Ext. frm Holder	L3 Overall Length	D2 Shank Style/Size	Num of Inserts
Q0437087N6R01	1.719	43.7mm	3.44	5.43	7.79	1.250 Universal	2
Q0445089N6R01	1.750	44.5mm	3.50	5.59	7.95	1.250 Universal	2
Q0452090N7R01	1.781	45.2mm	3.56	5.59	8.35	1.500 Universal	2
Q0460092N7R01	1.813	46.0mm	3.63	5.71	8.46	1.500 Universal	2
Q0476095N7R01	1.875	47.6mm	3.75	5.91	8.66	1.500 Universal	2
Q0492098N7R01	1.937	49.2mm	3.87	5.98	8.74	1.500 Universal	2
Q0500100N7R01	1.969	50.0mm	3.94	6.10	8.86	1.500 Universal	2
Q0508102N7R01	2.000	50.8mm	4.00	6.22	8.98	1.500 Universal	2

For inserts, see [page 528](#). For hardware, see [page 529](#).
Operating guidelines on [page 686](#).

SQUARE INSERT INDEXABLE DRILLS

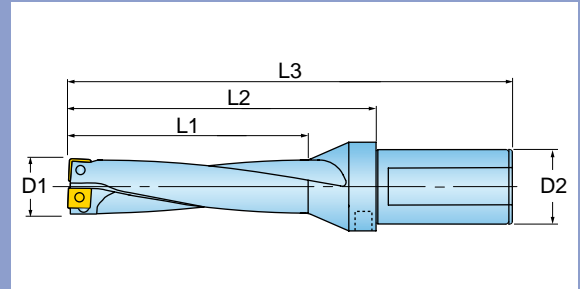

Part Number	D1 Nom. Dia. inch	D1 Nom. Dia. mm	L1 Drilling Length	L2 Ext. frm Holder	L3 Overall Length	D2 Shank Style/Size	Num of Inserts
Q0127038N5R01	0.500	12.7mm	1.50	2.56	4.76	1.000 Universal	2
Q0135041N5R01	0.531	13.5mm	1.59	2.68	4.88	1.000 Universal	2
Q0143043N5R01	0.563	14.3mm	1.69	2.68	4.88	1.000 Universal	2
Q0150045N5R01	0.594	15.0mm	1.78	2.83	5.03	1.000 Universal	2
Q0159048N5R01	0.626	15.9mm	1.88	2.99	5.20	1.000 Universal	2
Q0167050N5R01	0.657	16.7mm	1.97	3.11	5.31	1.000 Universal	2
Q0175053N5R01	0.688	17.5mm	2.06	3.27	5.47	1.000 Universal	2
Q0183055N5R01	0.719	18.3mm	2.16	3.27	5.47	1.000 Universal	2
Q0191057N5R01	0.750	19.0mm	2.25	3.39	5.59	1.000 Universal	2
Q0198059N5R01	0.781	19.8mm	2.34	3.59	5.79	1.000 Universal	2
Q0206062N5R01	0.813	20.6mm	2.44	3.70	5.91	1.000 Universal	2
Q0214064N5R02	0.843	21.4mm	2.53	3.82	6.02	1.000 Universal	2
Q0222067N5R02	0.875	22.2mm	2.63	3.82	6.02	1.000 Universal	2
Q0230069N6R01	0.906	23.0mm	2.72	4.09	6.46	1.250 Universal	2
Q0238071N6R01	0.938	23.8mm	2.81	4.25	6.61	1.250 Universal	2
Q0246074N6R01	0.969	24.6mm	2.91	4.41	6.77	1.250 Universal	2
Q0250075N6R01	0.984	25.0mm	2.95	4.06	6.34	1.250 Universal	2
Q0254076N6R01	1.000	25.4mm	3.00	4.53	6.89	1.250 Universal	2
Q0262079N6R01	1.031	26.2mm	3.09	4.53	6.89	1.250 Universal	2
Q0270081N6R01	1.063	27.0mm	3.19	4.65	7.01	1.250 Universal	2
Q0278083N6R02	1.094	27.8mm	3.28	4.80	7.17	1.250 Universal	2
Q0286086N6R02	1.125	28.6mm	3.38	4.92	7.28	1.250 Universal	2
Q0294088N6R01	1.156	29.4mm	3.47	5.16	7.52	1.250 Universal	2
Q0302090N6R01	1.187	30.2mm	3.56	5.16	7.52	1.250 Universal	2
Q0310093N6R01	1.219	31.0mm	3.66	5.31	7.67	1.250 Universal	2
Q0318095N6R01	1.250	31.7mm	3.75	5.43	7.79	1.250 Universal	2
Q0325098N6R01	1.281	32.5mm	3.84	5.59	7.95	1.250 Universal	2
Q0333100N6R01	1.312	33.3mm	3.94	5.59	7.95	1.250 Universal	2
Q0341102N6R02	1.343	34.1mm	4.03	5.71	8.07	1.250 Universal	2
Q0349105N6R02	1.375	34.9mm	4.13	5.87	8.23	1.250 Universal	2
Q0357107N6R02	1.406	35.7mm	4.22	6.02	8.38	1.250 Universal	2
Q0365110N6R01	1.437	36.5mm	4.31	6.18	8.54	1.250 Universal	2
Q0373112N6R01	1.468	37.3mm	4.40	6.18	8.54	1.250 Universal	2
Q0381114N6R01	1.500	38.1mm	4.50	6.34	8.70	1.250 Universal	2
Q0389117N6R01	1.531	38.9mm	4.59	6.46	8.82	1.250 Universal	2
Q0397119N6R01	1.562	39.7mm	4.69	6.61	8.97	1.250 Universal	2
Q0405122N6R01	1.594	40.5mm	4.78	6.77	9.13	1.250 Universal	2
Q0413124N6R01	1.625	41.3mm	4.88	6.77	9.13	1.250 Universal	2
Q0428128N6R02	1.687	42.8mm	5.06	7.05	9.41	1.250 Universal	2

SQUARE INSERT INDEXABLE DRILLS

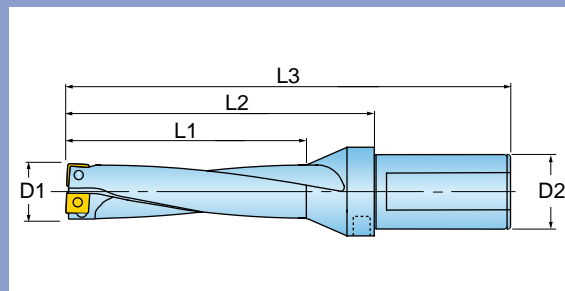

Part Number	D1 Nom. Dia. inch	D1 Nom. Dia. mm	L1 Drilling Length	L2 Ext. frm Holder	L3 Overall Length	D2 Shank Style/Size	Num of Inserts
Q0437131N6R01	1.719	43.7mm	5.16	7.17	9.53	1.250 Universal	2
Q0445134N6R01	1.750	44.5mm	5.25	7.36	9.72	1.250 Universal	2
Q0452136N7R01	1.781	45.2mm	5.34	7.36	10.12	1.500 Universal	2
Q0460138N7R01	1.813	46.0mm	5.44	7.52	10.28	1.500 Universal	2
Q0476143N7R01	1.875	47.6mm	5.63	7.80	10.55	1.500 Universal	2
Q0492148N7R01	1.937	49.2mm	5.81	7.91	10.67	1.500 Universal	2
Q0500150N7R01	1.969	50.0mm	5.91	8.07	10.83	1.500 Universal	2
Q0508152N7R01	2.000	50.8mm	6.00	8.23	10.98	1.500 Universal	2

For inserts, see [page 528](#). For hardware, see [page 529](#).
Operating guidelines on [page 686](#).

SQUARE INSERT INDEXABLE DRILLS

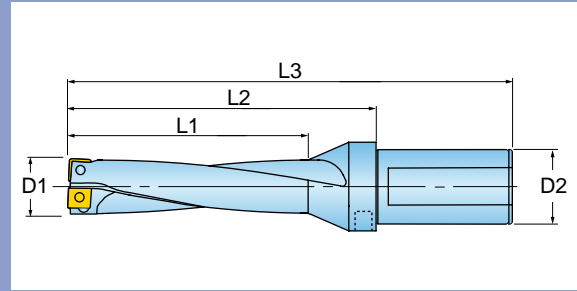

Part Number	D1 Nom. Dia. inch	D1 Nom. Dia. mm	L1 Drilling Length	L2 Ext. frm Holder	L3 Overall Length	D2 Shank Style/Size	Num of Inserts
Q0127051N5R01	0.500	12.7mm	2.00	3.07	5.27	1.000 Universal	2
Q0135054N5R01	0.531	13.5mm	2.12	3.23	5.43	1.000 Universal	2
Q0143057N5R01	0.563	14.3mm	2.25	3.23	5.43	1.000 Universal	2
Q0150060N5R01	0.594	15.0mm	2.38	3.43	5.63	1.000 Universal	2
Q0159064N5R01	0.626	15.9mm	2.50	3.62	5.83	1.000 Universal	2
Q0167067N5R01	0.657	16.7mm	2.63	3.78	5.98	1.000 Universal	2
Q0175070N5R01	0.688	17.5mm	2.75	3.98	6.18	1.000 Universal	2
Q0183073N5R01	0.719	18.3mm	2.88	3.98	6.18	1.000 Universal	2
Q0191076N5R01	0.750	19.0mm	3.00	4.13	6.34	1.000 Universal	2
Q0198079N5R01	0.781	19.8mm	3.12	4.37	6.57	1.000 Universal	2
Q0206082N5R01	0.813	20.6mm	3.25	4.53	6.73	1.000 Universal	2
Q0214086N5R02	0.843	21.4mm	3.37	4.69	6.89	1.000 Universal	2
Q0222089N5R02	0.875	22.2mm	3.50	4.69	6.89	1.000 Universal	2
Q0230092N6R01	0.906	23.0mm	3.62	5.00	7.36	1.250 Universal	2
Q0238095N6R01	0.938	23.8mm	3.75	5.20	7.56	1.250 Universal	2
Q0246098N6R01	0.969	24.6mm	3.88	5.39	7.76	1.250 Universal	2
Q0250100N6R01	0.984	25.0mm	3.94	5.04	7.32	1.250 Universal	2
Q0254102N6R01	1.000	25.4mm	4.00	5.55	7.91	1.250 Universal	2
Q0262105N6R01	1.031	26.2mm	4.12	5.55	7.91	1.250 Universal	2
Q0270108N6R01	1.063	27.0mm	4.25	5.71	8.27	1.250 Universal	2
Q0278111N6R02	1.094	27.8mm	4.38	5.91	7.79	1.250 Universal	2
Q0286114N6R02	1.125	28.6mm	4.50	6.06	8.43	1.250 Universal	2
Q0294118N6R01	1.156	29.4mm	4.62	6.34	8.70	1.250 Universal	2
Q0302120N6R01	1.187	30.2mm	4.75	6.34	8.90	1.250 Universal	2
Q0310124N6R01	1.219	31.0mm	4.88	6.54	8.82	1.250 Universal	2
Q0318127N6R01	1.250	31.8mm	5.00	6.69	9.05	1.250 Universal	2
Q0325130N6R01	1.281	32.5mm	5.12	6.89	9.25	1.250 Universal	2
Q0333133N6R01	1.312	33.3mm	5.25	6.89	9.25	1.250 Universal	2
Q0341136N6R02	1.343	34.1mm	5.37	6.65	9.33	1.250 Universal	2
Q0349140N6R02	1.375	34.9mm	5.50	7.24	9.60	1.250 Universal	2
Q0357143N6R02	1.406	35.7mm	5.62	7.44	9.80	1.250 Universal	2
Q0365146N6R01	1.437	36.5mm	5.75	7.64	10.00	1.250 Universal	2
Q0373149N6R01	1.468	37.3mm	5.87	7.64	10.00	1.250 Universal	2
Q0381152N6R01	1.500	38.1mm	6.00	7.83	10.19	1.250 Universal	2
Q0389156N6R01	1.531	38.9mm	6.12	7.99	10.35	1.250 Universal	2
Q0397159N6R01	1.562	39.7mm	6.25	8.19	10.55	1.250 Universal	2
Q0405162N6R01	1.594	40.5mm	6.38	8.39	10.75	1.250 Universal	2
Q0413165N6R01	1.625	41.3mm	6.50	8.39	10.75	1.250 Universal	2
Q0428171N6R02	1.687	42.8mm	6.75	8.74	11.10	1.250 Universal	2

SQUARE INSERT INDEXABLE DRILLS

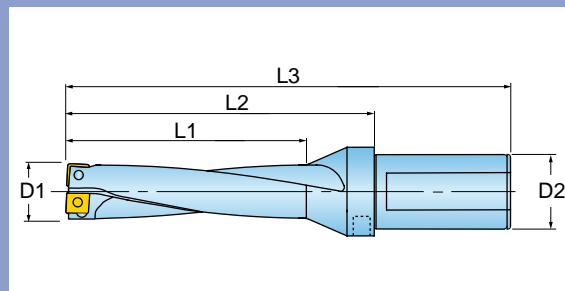

Part Number	D1 Nom. Dia. inch	D1 Nom. Dia. mm	L1 Drilling Length	L2 Ext. frm Holder	L3 Overall Length	D2 Shank Style/Size	Num of Inserts
Q0437175N6R01	1.719	43.7mm	6.88	8.90	11.26	1.250 Universal	2
Q0445178N6R01	1.750	44.5mm	7.00	9.13	11.49	1.250 Universal	2
Q0452181N7R01	1.781	45.2mm	7.12	9.13	11.89	1.500 Universal	2
Q0460184N7R01	1.813	46.0mm	7.25	9.33	12.09	1.500 Universal	2
Q0476190N7R01	1.875	47.6mm	7.50	9.69	12.44	1.500 Universal	2
Q0492197N7R01	1.937	49.2mm	7.75	9.84	12.60	1.500 Universal	2
Q0500200N7R01	1.969	50.0mm	7.88	10.04	12.80	1.500 Universal	2
Q0508203N7R01	2.000	50.8mm	8.00	10.24	12.99	1.500 Universal	2

For inserts, see [page 528](#). For hardware, see [page 529](#).
Operating guidelines on [page 686](#).

SQUARE INSERT INDEXABLE DRILLS

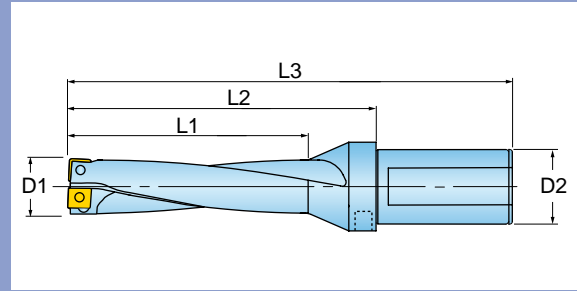

Part Number	D1 Nom. Dia. inch	D1 Nom. Dia. mm	L1 Drilling Length	L2 Ext. frm Holder	L3 Overall Length	D2 Shank Style/Size	Num of Inserts
Q0127064N5R01	0.500	12.7mm	2.50	3.57	5.77	1.000 Universal	2
Q0135067N5R01	0.531	13.3mm	2.65	3.76	5.96	1.000 Universal	2
Q0143072N5R01	0.563	14.3mm	2.81	3.79	5.99	1.000 Universal	2
Q0150075N5R01	0.594	15.1mm	2.97	4.02	6.22	1.000 Universal	2
Q0159080N5R01	0.625	15.9mm	3.13	4.25	6.46	1.000 Universal	2
Q0167083N5R01	0.657	16.7mm	3.29	4.45	6.65	1.000 Universal	2
Q0175087N5R01	0.688	17.5mm	3.44	4.69	6.89	1.000 Universal	2
Q0183091N5R01	0.719	18.3mm	3.60	4.69	6.89	1.000 Universal	2
Q0191095N5R01	0.750	19.1mm	3.75	4.88	7.09	1.000 Universal	2
Q0198099N5R01	0.781	19.8mm	3.91	5.16	7.36	1.000 Universal	2
Q0206103N5R01	0.813	20.7mm	4.07	5.35	7.56	1.000 Universal	2
Q0214107N5R01	0.844	21.4mm	4.22	5.55	7.76	1.000 Universal	2
Q0222111N5R01	0.875	22.2mm	4.38	5.55	7.76	1.000 Universal	2
Q0230115N6R01	0.906	23.0mm	4.53	5.91	8.27	1.250 Universal	2
Q0238119N6R01	0.938	23.8mm	4.69	6.14	8.50	1.250 Universal	2
Q0246123N6R01	0.969	24.6mm	4.85	6.38	8.74	1.250 Universal	2
Q0250125N6R01	0.984	25.0mm	4.92	6.38	8.74	1.250 Universal	2
Q0254127N6R01	1.000	25.4mm	5.00	6.57	8.94	1.250 Universal	2
Q0262131N6R01	1.031	26.2mm	5.16	6.57	8.94	1.250 Universal	2
Q0270135N6R01	1.063	27.0mm	5.32	6.77	9.13	1.250 Universal	2
Q0278139N6R02	1.094	27.8mm	5.47	7.00	9.36	1.250 Universal	2
Q0286143N6R02	1.125	28.6mm	5.62	7.19	9.55	1.250 Universal	2
Q0294147N6R01	1.156	29.4mm	5.78	7.49	9.86	1.250 Universal	2
Q0302151N6R01	1.187	30.1mm	5.93	7.53	9.89	1.250 Universal	2
Q0310155N6R01	1.219	31.0mm	6.09	7.75	10.12	1.250 Universal	2
Q0318159N6R01	1.250	31.8mm	6.25	7.94	10.31	1.250 Universal	2
Q0325163N6R01	1.281	32.5mm	6.40	8.17	10.53	1.250 Universal	2
Q0333167N6R01	1.312	33.3mm	6.56	8.20	10.56	1.250 Universal	2
Q0341171N6R02	1.343	34.1mm	6.71	8.39	10.75	1.250 Universal	2
Q0349175N6R02	1.375	34.9mm	6.87	8.62	10.98	1.250 Universal	2
Q0357179N6R02	1.406	35.7mm	7.03	8.85	11.21	1.250 Universal	2
Q0365182N6R01	1.437	36.5mm	7.18	9.07	11.44	1.250 Universal	2
Q0373186N6R01	1.468	37.3mm	7.34	9.11	11.47	1.250 Universal	2
Q0381191N6R01	1.500	38.1mm	7.50	9.33	11.70	1.250 Universal	2
Q0389194N6R01	1.531	38.9mm	7.65	9.52	11.89	1.250 Universal	2
Q0405202N6R01	1.594	40.5mm	7.97	9.98	12.34	1.250 Universal	2
Q0413206N6R01	1.625	41.3mm	8.12	10.01	12.37	1.250 Universal	2

For inserts, see [page 528](#). For hardware, see [page 529](#).
Operating guidelines on [page 686](#).

QUADODRILL™ SERIES Q INDEXABLE DRILLS 2:1 LARGE

LARGE INDEXABLE DRILLS



Drilling



Coolant

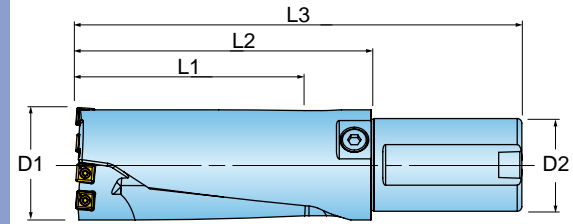

Part Number	D1 Nom. Dia. inch	D1 Nom. Dia. mm	L1 Drilling Length	L2 Ext. frm Holder	L3 Overall Length	D2 Shank Style/Size	Num of Inserts
Q0539108N8R01	2.125	53.9mm	4.25	6.00	9.25	2.000 Universal	4
Q0571114N8R01	2.250	57.1mm	4.50	6.00	9.25	2.000 Universal	4
Q0603121N8R01	2.375	60.3mm	4.75	6.50	9.75	2.000 Universal	4
Q0635127N8R01	2.500	63.5mm	5.00	6.38	9.63	2.000 Universal	4
Q0666133N8R01	2.625	66.6mm	5.25	6.75	10.00	2.000 Universal	4
Q0698140N8R01	2.750	69.8mm	5.50	7.00	10.25	2.000 Universal	4
Q0730146N8R01	2.875	73.0mm	5.75	7.25	10.50	2.000 Universal	4
Q0762152N8R01	3.000	76.2mm	6.00	7.50	10.75	2.000 Universal	4
Q0825165N8R01	3.250	82.5mm	6.50	8.00	11.25	2.000 Universal	4

For inserts, see [page 528](#). For hardware, see [page 529](#).
Operating guidelines on [page 686](#).

QUADODRILL™ SERIES Q INDEXABLE DRILLS 3:1 LARGE

LARGE INDEXABLE DRILLS

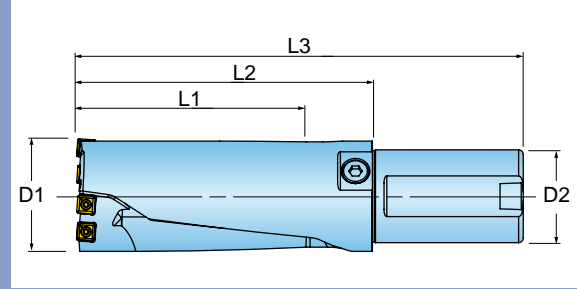

Part Number	D1 Nom. Dia. inch	D1 Nom. Dia. mm	L1 Drilling Length	L2 Ext. frm Holder	L3 Overall Length	D2 Shank Style/Size	Num of Inserts
Q0539162N8R01	2.125	53.9mm	6.38	7.88	11.13	2.000 Universal	4
Q0571172N8R01	2.250	57.1mm	6.75	8.25	11.50	2.000 Universal	4
Q0603181N8R01	2.375	60.3mm	7.13	8.88	12.13	2.000 Universal	4
Q0635191N8R01	2.500	63.5mm	7.50	8.88	12.13	2.000 Universal	4
Q0666200N8R01	2.625	66.6mm	7.88	8.38	12.63	2.000 Universal	4
Q0698210N8R01	2.750	69.8mm	8.25	9.75	13.00	2.000 Universal	4
Q0730219N8R01	2.875	73.0mm	8.63	10.13	13.38	2.000 Universal	4
Q0762229N8R01	3.000	76.2mm	9.00	10.50	13.75	2.000 Universal	4
Q0825248N8R01	3.250	82.5mm	9.75	11.25	14.50	2.000 Universal	4

For inserts, see [page 528](#). For hardware, see [page 529](#).
Operating guidelines on [page 686](#).

QUADODRILL™ SERIES Q INDEXABLE DRILLS 4:1 LARGE

LARGE INDEXABLE DRILLS

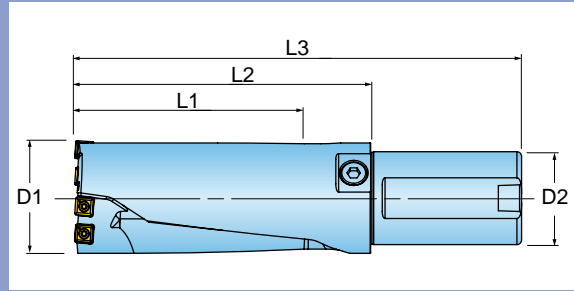

Part Number	D1 Nom. Dia. inch	D1 Nom. Dia. mm	L1 Drilling Length	L2 Ext. frm Holder	L3 Overall Length	D2 Shank Style/Size	Num of Inserts
Q0539216N8R01	2.125	54.0mm	8.50	10.00	13.25	2.000 Universal	4
Q0571229N8R01	2.250	57.2mm	9.00	10.50	13.75	2.000 Universal	4
Q0603241N8R01	2.375	60.3mm	11.25	11.25	14.50	2.000 Universal	4
Q0635254N8R01	2.500	63.5mm	10.00	11.25	14.63	2.000 Universal	4
Q0666267N8R01	2.625	66.7mm	10.50	12.00	15.25	2.000 Universal	4
Q0698279N8R02	2.750	69.9mm	11.00	12.50	15.75	2.000 Universal	4
Q0730292N8R01	2.875	73.0mm	11.50	13.00	16.25	2.000 Universal	4
Q0762305N8R01	3.000	76.2mm	12.00	13.50	16.75	2.000 Universal	4
Q0825330N8R01	3.250	82.6mm	13.00	14.50	17.75	2.000 Universal	4

For inserts, see [page 528](#). For hardware, see [page 529](#).
Operating guidelines on [page 686](#).

QUADODRILL™ AND QUADODRILL+™ INSERTS FOR SERIES Q DRILLS

INSERTS

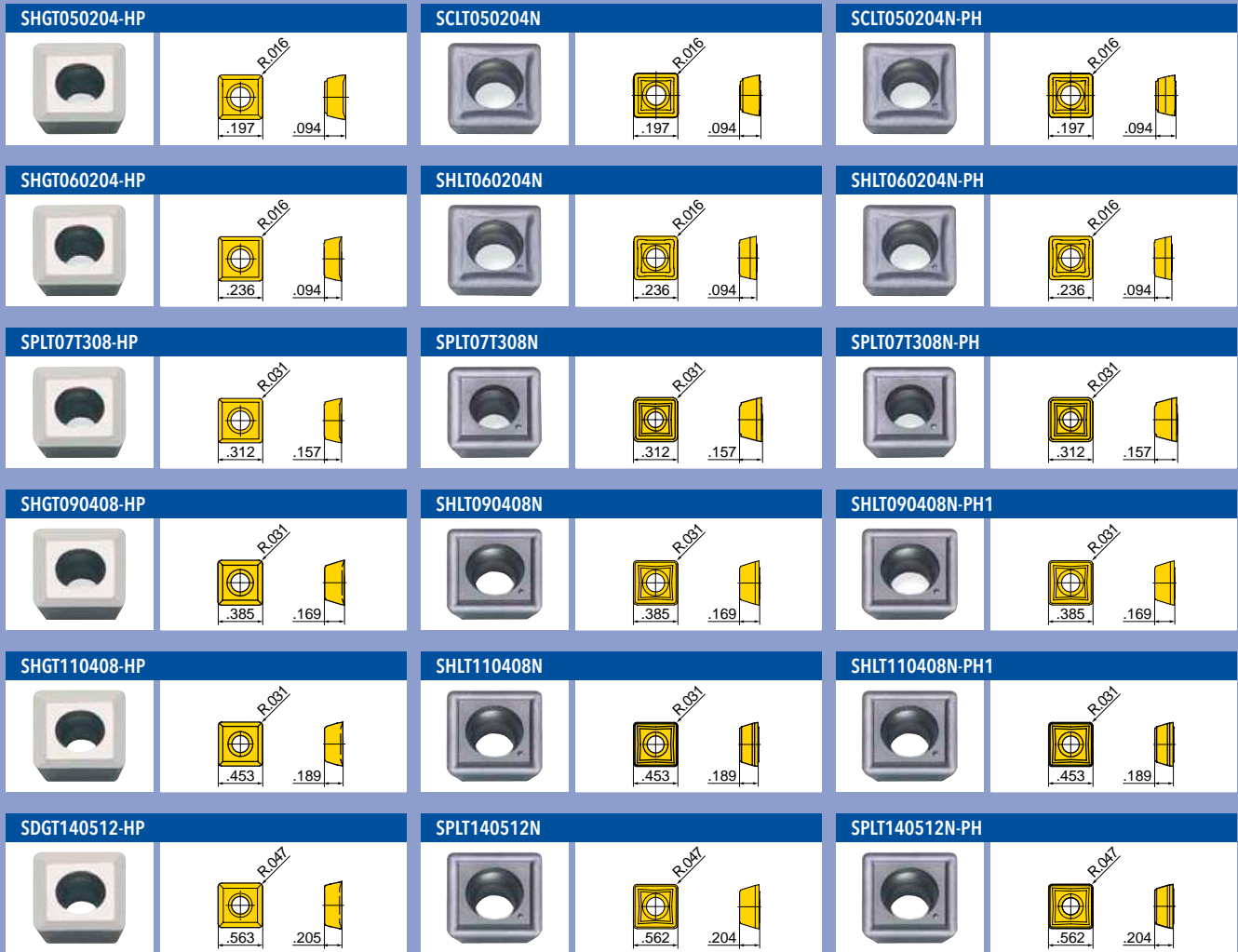

Drill Diameter	Part Number	Applications	Grade								
			IN1030	IN10K	IN2005	IN2010	IN6520				
.500-.594	SHGT050204-HP	Grd/Pol for Al - 0.016" R		●							
.500-.594	SCLT050204N	Cast Iron - 0.016" R				●					
.500-.594	SCLT050204N-PH	Multi-Purpose - 0.015" R	●		●		●	●			
.625-.813	SHGT060204-HP	Grd/Pol for Al - 0.016" R		●							
.625-.813	SHLT060204N	Cast Iron - 0.016" R				●					
.625-.813	SHLT060204N-PH	Multi-Purpose - 0.016" R	●		●		●	●			
.843-1.063 + 2.125	SDGT07T308-HP	Grd/Pol for Al - 0.030" R		●							
.843-1.063 + 2.125	SPLT07T308N	Cast Iron - 0.030" R				●					
.843-1.063 + 2.125	SPLT07T308N-PH	Multi-Purpose - 0.030" R	●		●		●	●			
1.094-1.312, 2.250-2.750	SHGT090408-HP	Grd/Pol for Al - 0.030" R		●							
1.094-1.312, 2.250-2.750	SHLT090408N	Cast Iron - 0.030" R				●					
1.094-1.312, 2.250-2.750	SHLT090408N-PH1	Multi-Purpose - 0.030" R	●		●		●	●			
1.343-1.625, 2.875-3.000	SHGT110408-HP	Grd/Pol for Al - 0.030" R		●							
1.343-1.625, 2.875-3.000	SHLT110408N	Cast Iron - 0.030" R				●					
1.343-1.625, 2.875-3.000	SHLT110408N-PH1	Multi-Purpose - 0.030" R	●		●		●	●			
1.687-2.000 + 3.250	SDGT140512-HP	Grd/Pol for Al - 0.047" R		●							
1.687-2.000 + 3.250	SPLT140512N	Cast Iron - 0.047" R				●					
1.687-2.000 + 3.250	SPLT140512N-PH	Multi-Purpose - 0.047" R	●		●		●	●			

● = P ● = M ● = K ● = N ● = S

HARDWARE

Insert Screw		Driver		Coolant Fitting
Drill Diameter	Part No.	Torque	Part No.	
.500-.594	SM20-043-00	5-9 in. lbs.	DS-TP06S	PF-0012
.625-.813	SM22-052-00	7-11 in. lbs.	DS-T07F (Tx-07)	PF-0012
.843-1.063 + 2.125	SM25-064-00	10-15 in. lbs.	DS-T08W (Tx-08)	PF-0013
1.094-1.312, 2.250-2.750	SM35-088-60	25-30 in. lbs.	DS-T10T (Tx-10)	-
1.343-1.625, 2.875-3.000	SM40-093-20	30-35 in. lbs.	DS-T15T (Tx-15)	-
1.687 - 2.000 + 3.250	SM50-122-50	40-45 in. lbs.	DS-T20T (Tx-20)	-

SQUARE INSERT ADJUSTABLE CARTRIDGE DRILL

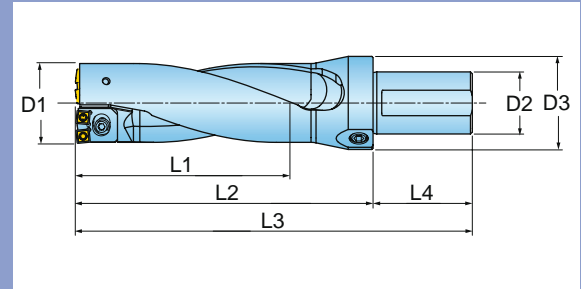

Drill Number	D1 Drill Dia. Range	L1 Drilling Length	L2 Ext. from Holder	L3 Overall Length	L4 Shank Length	D2 Shank Dia. & Style	D3 Flange Dia.	# of Inserts	Setting Plates Part Number	Setting Plates Plate Thickness	Cartridge Outboard	Cartridge Inboard
QA0540111N8R01	2.125 2.188	4.41	5.98	9.23	3.25	2.000 Universal	2.95	4	DS07-080-01	.031	55E223R01	55E213R01
QA0572121N8R01	2.250 2.313 2.375	4.82	6.69	9.94	3.25	2.000 Universal	2.95	4	DS09-080-01 DS09-159-01	.031 .063	55F243R02	55F233R01
QA0619130N8R01	2.438 2.500 2.563	5.13	7.17	10.42	3.25	2.000 Universal	2.95	4	DS09-080-01 DS09-159-01	.031 .063	55F263R01	55F243R03
QA0667143N8R01	2.625 2.688 2.750 2.813	5.67	7.99	11.24	3.25	2.000 Universal	2.95	4	DS11-080-01 DS11-159-01 DS11-238-01	.031 .063 .094	55G294R01	55G264R01
QA0730159N8R01	2.875 2.938 3.000 3.063 3.125	6.25	8.27	11.52	3.25	2.000 Universal	2.95	4	DS11-080-01 DS11-159-01 DS11-238-01 DS11-320-01	.031 .063 .094 .125	55H314R00	55H294R00

For inserts, see [page 532](#).

Operating guidelines on [page 686](#).

HARDWARE

Drill Diameter Size Range	Insert Screw	Insert Screw Wrench
2.125-2.188	SM25-064-00	DS-T08W (Tx-08)
2.250-2.375	SM35-088-60	DS-T10T (Tx-10)
2.437-2.563	SM35-088-60	DS-T10T (Tx-10)
2.625-2.813	SM40-093-20	DS-T15T (Tx-15)
2.875-3.125	SM40-093-20	DS-T15T (Tx-15)

Drill Diameter Size Range	Setting Plate Screw	Setting Plate Screw Wrench
2.125-2.188	SM20-043-00	DS-TP06S (TxP-06)
2.250-2.375	SM30-055-10	DS-T09W (Tx-09)
2.437-2.563	SM30-055-10	DS-T09W (Tx-09)
2.625-2.813	SM30-055-10	DS-T09W (Tx-09)
2.875-3.125	SM30-055-10	DS-T09W (Tx-09)

Drill Diameter Size Range	Outboard Cartridge	Inboard Cartridge	Cartridge Mounting Screw	Cartridge Mounting Screw Washer	Allen Wrench
2.125-2.188	55E223R01	55E213R01	SD040-16 (M4 X 0.7 X 16MM SHCS)	WA004-01 (4.3MM X 8MM)	L-W3 (3MM)
2.250-2.375	55F243R02	55F233R01	SD050-16 (M5 X 0.8 X 16MM SHCS)	WA005-01 (5.5MM X 10MM)	L-W4 (4MM)
2.437-2.563	55F263R01	55F243R03	SD050-16 (M5 X 0.8 X 16MM SHCS)	WA005-01 (5.5MM X 10MM)	L-W4 (4MM)
2.625-2.813	55G294R01	55G264R01	SD060-20 (M6 X 1 X 20MM SHCS)	WA006-01 (6.4 MM X 12MM)	L-W5 (5MM)
2.875-3.125	55H314R00	55H294R00	SD060-20 (M6 X 1 X 20MM SHCS)	WA006-01 (6.4 MM X 12MM)	L-W5 (5MM)

SQUARE INSERT ADJUSTABLE CARTRIDGE DRILL

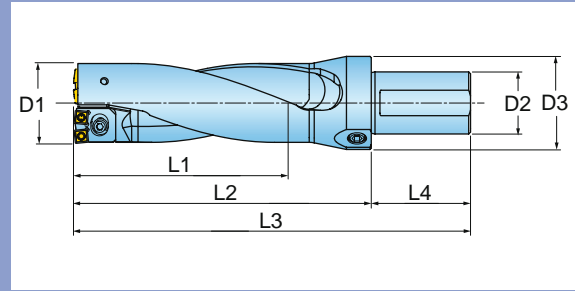

Drill Number	D1 Drill Dia. Range	L1 Drilling Length	L2 Ext. from Holder	L3 Overall Length	L4 Shank Length	D2 Shank Dia. & Style	D3 Flange Dia.	# of Inserts	Setting Plates Part Number	Setting Plates Plate Thickness	Cartridge Outboard	Cartridge Inboard
QA0540167N8R01	2.125 2.188	6.61	8.19	11.44	3.25	2.000 Universal	2.95	4	DS07-080-01	.031	55E223R01	55E213R01
QA0572181N8R01	2.250 2.313 2.375	7.23	9.13	12.38	3.25	2.000 Universal	2.95	4	DS09-080-01 DS09-159-01	.031 .063	55F243R02	55F233R01
QA0619195N8R01	2.438 2.500 2.563	7.69	9.76	13.01	3.25	2.000 Universal	2.95	4	DS09-080-01 DS09-159-01	.031 .063	55F263R01	55F243R03
QA0667214N8R01	2.625 2.688 2.750 2.813	8.50	10.87	14.12	3.25	2.000 Universal	2.95	4	DS11-080-01 DS11-159-01 DS11-238-01	.031 .063 .094	55G294R01	55G264R01
QA0730238N8R01	2.875 2.938 3.000 3.063 3.125	9.38	11.42	14.67	3.25	2.000 Universal	2.95	4	DS11-080-01 DS11-159-01 DS11-238-01 DS11-320-01	.031 .063 .094 .125	55H314R00	55H294R00

For inserts, see [page 532](#).

Operating guidelines on [page 686](#).

HARDWARE

Drill Diameter Size Range	Insert Screw	Insert Screw Wrench	Drill Diameter Size Range	Setting Plate Screw	Setting Plate Screw Wrench
2.125-2.188	SM25-064-00	DS-T08W (Tx-08)	2.125-2.188	SM20-043-00	DS-TP06S (TxP-06)
2.250-2.375	SM35-088-60	DS-T10T (Tx-10)	2.250-2.375	SM30-055-10	DS-T09W (Tx-09)
2.437-2.563	SM35-088-60	DS-T10T (Tx-10)	2.437-2.563	SM30-055-10	DS-T09W (Tx-09)
2.625-2.813	SM40-093-20	DS-T15T (Tx-15)	2.625-2.813	SM30-055-10	DS-T09W (Tx-09)
2.875-3.125	SM40-093-20	DS-T15T (Tx-15)	2.875-3.125	SM30-055-10	DS-T09W (Tx-09)

Drill Diameter Size Range	Outboard Cartridge	Inboard Cartridge	Cartridge Mounting Screw	Cartridge Mounting Screw Washer	Allen Wrench
2.125-2.188	55E223R01	55E213R01	SD040-16 (M4 X 0.7 X 16MM SHCS)	WA004-01 (4.3MM X 8MM)	L-W3 (3MM)
2.250-2.375	55F243R02	55F233R01	SD050-16 (M5 X 0.8 X 16MM SHCS)	WA005-01 (5.5MM X 10MM)	L-W4 (4MM)
2.437-2.563	55F263R01	55F243R03	SD050-16 (M5 X 0.8 X 16MM SHCS)	WA005-01 (5.5MM X 10MM)	L-W4 (4MM)
2.625-2.813	55G294R01	55G264R01	SD060-20 (M6 X 1 X 20MM SHCS)	WA006-01 (6.4 MM X 12MM)	L-W5 (5MM)
2.875-3.125	55H314R00	55H294R00	SD060-20 (M6 X 1 X 20MM SHCS)	WA006-01 (6.4 MM X 12MM)	L-W5 (5MM)

INSERTS

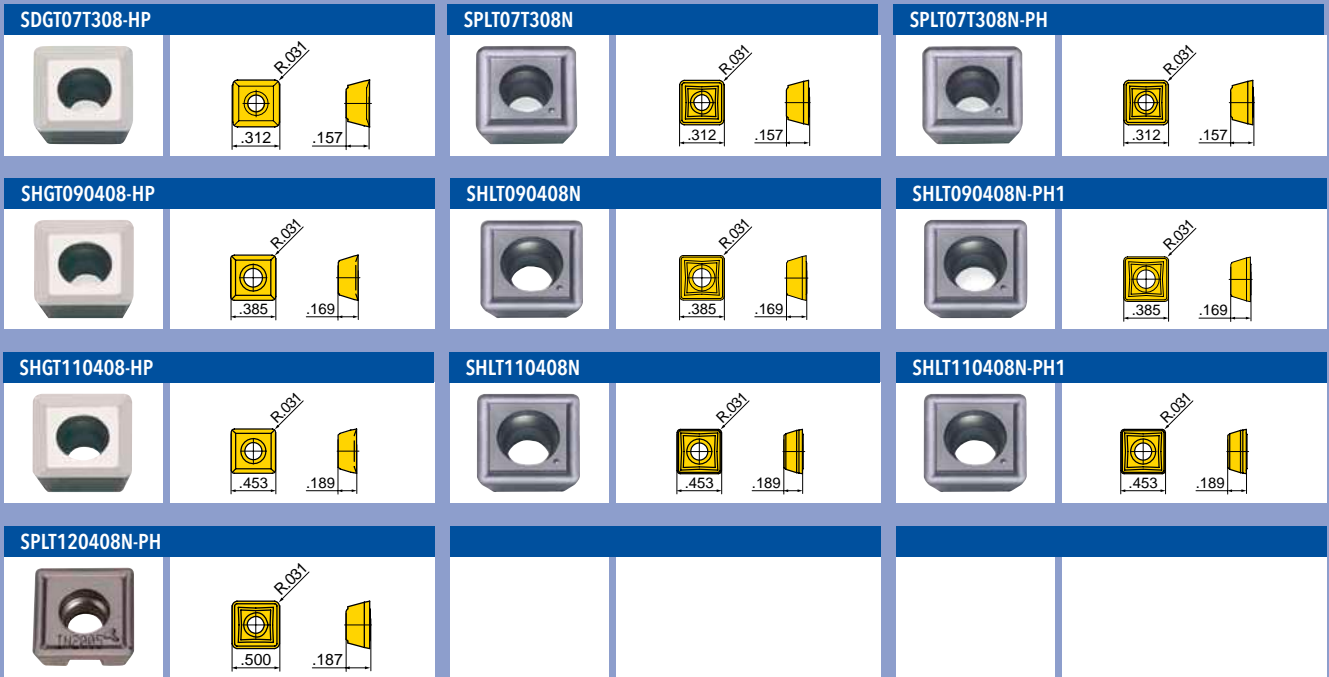

Part Number	Applications	Grade	IN1030	IN10K	IN2005	IN2010	IN6520			
SDGT07T308-HP	Grd/Pol for Al - 0.030" R			●						
SPLT07T308N	Cast Iron - 0.030" R					●				
SPLT07T308N-PH	Multi-Purpose - 0.030" R		●		●		●			
SHGT090408-HP	Grd/Pol for Al - 0.030" R			●						
SHLT090408N	Cast Iron - 0.030" R					●				
SHLT090408N-PH1	Multi-Purpose - 0.030" R		●		●		●			
SHGT110408-HP	Grd/Pol for Al - 0.030" R			●						
SHLT110408N	Cast Iron - 0.030" R					●				
SHLT110408N-PH1	Multi-Purpose - 0.030" R		●		●		●			
SPLT120408N-PH	Multi-Purpose - 0.030" R				●					

● = P ● = M ● = K ● = N ● = S

ASSEMBLY OF DRILL

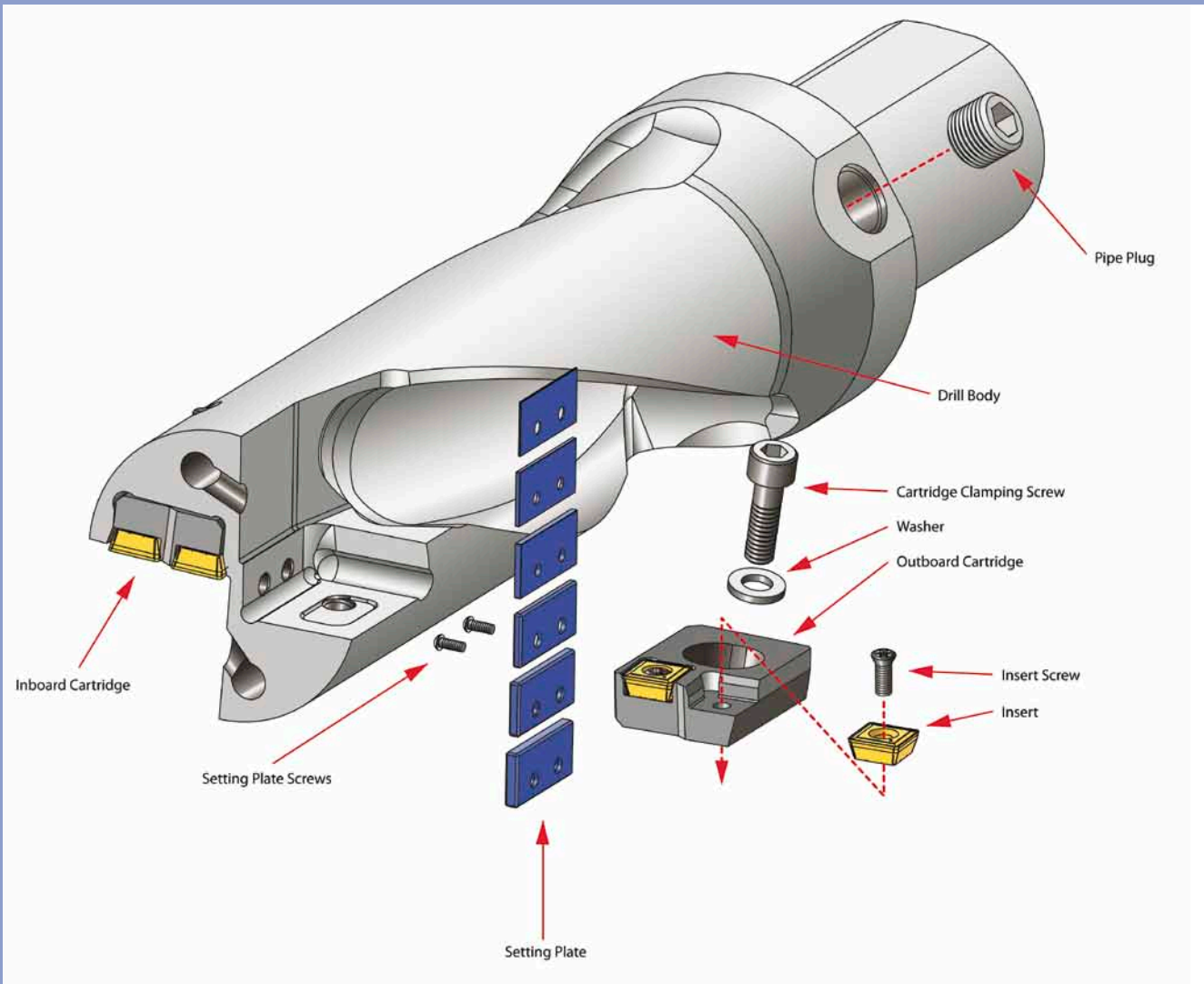

PACKAGE

Each drill will be packaged with the following:

- Drill Body - 1 piece
- Inboard Cartridge - 1 piece
- Outboard Cartridge - 1 piece
- Required Setting Plates
- Setting Plate Screws - 2 pieces
- Cartridge Screws - 2 pieces
- Insert Screws - 6 pieces (2 extra)
- Cartridge Washer - 2 pieces
- Wrenches/Drivers - 3 pieces (Cartridge, Insert, Setting Plate)
- Pipe Plug - 1 piece

*Order inserts separately.

FLAT BOTTOM SQUARE INSERT INDEXABLE DRILL - 3:1

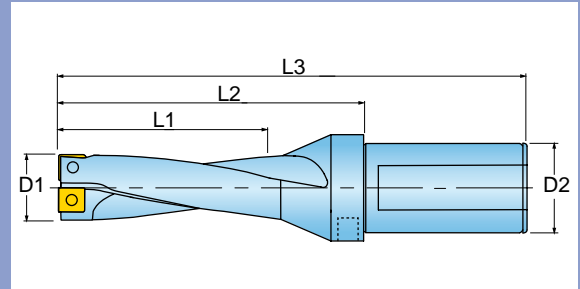

Part Number	D1 Nom. Dia. inch	D1 Nom. Dia. mm	L1 Drilling Length	L2 Ext. frm Holder	L3 Overall Length	D2 Shank Style/Size	Num of Inserts
QF0159048N5R01	0.625	15.9mm	1.88	2.99	5.20	1.000 Universal	2
QF0175053N5R01	0.688	17.5mm	2.06	3.27	5.47	1.000 Universal	2
QF0183055N5R01	0.719	18.3mm	2.16	3.27	5.47	1.000 Universal	2
QF0191057N5R01	0.750	19.1mm	2.25	3.39	5.59	1.000 Universal	2
QF0198059N5R01	0.781	19.8mm	2.34	3.58	5.79	1.000 Universal	2
QF0206062N5R01	0.813	20.7mm	2.44	3.70	5.91	1.000 Universal	2
QF0214064N5R01	0.843	21.4mm	2.53	3.82	6.02	1.000 Universal	2
QF0222067N5R01	0.875	22.2mm	2.63	3.82	6.02	1.000 Universal	2
QF0230069N6R01	0.906	23.0mm	2.72	4.09	6.46	1.250 Universal	2
QF0238071N6R01	0.938	23.8mm	2.81	4.25	6.61	1.250 Universal	2
QF0246074N6R01	0.969	24.6mm	2.91	4.41	6.77	1.250 Universal	2
QF0254076N6R01	1.000	25.4mm	3.00	4.53	6.89	1.250 Universal	2
QF0262079N6R01	1.031	26.2mm	3.09	4.53	6.89	1.250 Universal	2
QF0270081N6R01	1.063	27.0mm	3.19	4.65	7.01	1.250 Universal	2
QF0278083N6R01	1.094	27.8mm	3.28	4.80	7.17	1.250 Universal	2
QF0286086N6R01	1.125	28.6mm	3.38	4.92	7.28	1.250 Universal	2
QF0294088N6R01	1.156	29.4mm	3.47	5.16	7.52	1.250 Universal	2
QF0302090N6R01	1.187	30.1mm	3.56	5.16	7.52	1.250 Universal	2
QF0310093N6R01	1.219	31.0mm	3.66	5.31	7.67	1.250 Universal	2
QF0318095N6R01	1.250	31.8mm	3.75	5.43	7.79	1.250 Universal	2
QF0325098N6R01	1.281	32.5mm	3.84	5.59	7.95	1.250 Universal	2
QF0333100N6R01	1.312	33.3mm	3.94	5.59	7.95	1.250 Universal	2
QF0341102N6R01	1.343	34.1mm	4.03	5.71	8.07	1.250 Universal	2
QF0349105N6R01	1.175	34.9mm	4.03	5.87	8.23	1.250 Universal	2
QF0365110N6R01	1.437	36.5mm	4.31	6.18	8.54	1.250 Universal	2
QF0373112N6R01	1.468	37.3mm	4.40	6.18	8.54	1.250 Universal	2
QF0381114N6R01	1.500	38.1mm	4.50	6.34	8.70	1.250 Universal	2
QF0389117N6R01	1.531	38.9mm	4.59	6.46	8.82	1.250 Universal	2
QF0397119N6R01	1.562	39.7mm	4.69	6.61	9.37	1.250 Universal	2
QF0413124N6R01	1.625	41.3mm	4.88	6.77	9.53	1.250 Universal	2
QF0428128N6R01	1.687	42.8mm	5.06	7.05	9.80	1.250 Universal	2
QF0437131N6R01	1.719	43.7mm	5.16	7.17	9.92	1.250 Universal	2
QF0445134N6R01	1.750	44.4mm	5.25	7.36	10.12	1.250 Universal	2
QF0476143N7R01	1.875	47.6mm	5.63	7.80	10.55	1.500 Universal	2
QF0492148N7R01	1.937	49.2mm	5.81	7.91	10.67	1.500 Universal	2
QF0508152N7R01	2.000	50.8mm	6.00	8.23	10.98	1.500 Universal	4

For inserts, see page 536.
Operating guidelines on page 686.

HARDWARE

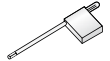

Screw

Driver

Driver

Coolant Fitting

QF0159048N5R01	SM20-043-00	DS-TP06S	-	PF-0012
QF0175053N5R01	SM22-052-00	DS-T07F	-	PF-0012
QF0183055N5R01	SM22-052-00	DS-T07F	-	PF-0012
QF0191057N5R01	SM22-052-00	DS-T07F	-	PF-0012
QF0198059N5R01	SM22-052-00	DS-T07F	-	PF-0012
QF0206062N5R01	SM22-052-00	DS-T07F	-	PF-0012
QF0214064N5R01	SM25-064-00	DS-T08W	-	PF-0013
QF0222067N5R01	SM25-064-00	DS-T08W	-	PF-0013
QF0230069N6R01	SM25-064-00	DS-T08W	-	PF-0013
QF0238071N6R01	SM25-064-00	DS-T08W	-	PF-0013
QF0246074N6R01	SM25-064-00	DS-T08W	-	PF-0013
QF0254076N6R01	SM25-064-00	DS-T08W	-	PF-0013
QF0262079N6R01	SM25-064-00	DS-T08W	-	PF-0013
QF0270081N6R01	SM25-064-00	DS-T08W	-	PF-0013
QF0278083N6R01	SM35-088-60	-	DS-T10T	-
QF0286086N6R01	SM35-088-60	-	DS-T10T	-
QF0294088N6R01	SM35-088-60	-	DS-T10T	-
QF0302090N6R01	SM35-088-60	-	DS-T10T	-
QF0310093N6R01	SM35-088-60	-	DS-T10T	-
QF0318095N6R01	SM35-088-60	-	DS-T10T	-
QF0325098N6R01	SM35-088-60	-	DS-T10T	-
QF0333100N6R01	SM35-088-60	-	DS-T10T	-
QF0341102N6R01	SM40-093-20	-	DS-T15T	-
QF0349105N6R01	SM40-093-20	-	DS-T15T	-
QF0365110N6R01	SM40-093-20	-	DS-T15T	-
QF0373112N6R01	SM40-093-20	-	DS-T15T	-
QF0381114N6R01	SM40-093-20	-	DS-T15T	-
QF0389117N6R01	SM40-093-20	-	DS-T15T	-
QF0397119N6R01	SM40-093-20	-	DS-T15T	-
QF0413124N6R01	SM40-093-20	-	DS-T15T	-
QF0428128N6R01	SM50-122-50	-	DS-T20T	-
QF0437131N6R01	SM50-122-50	-	DS-T20T	-
QF0445134N6R01	SM50-122-50	-	DS-T20T	-
QF0476143N7R01	SM50-122-50	-	DS-T20T	-
QF0492148N7R01	SM50-122-50	-	DS-T20T	-
QF0508152N7R01	SM25-064-00	DS-T08W	-	-

INSERTS

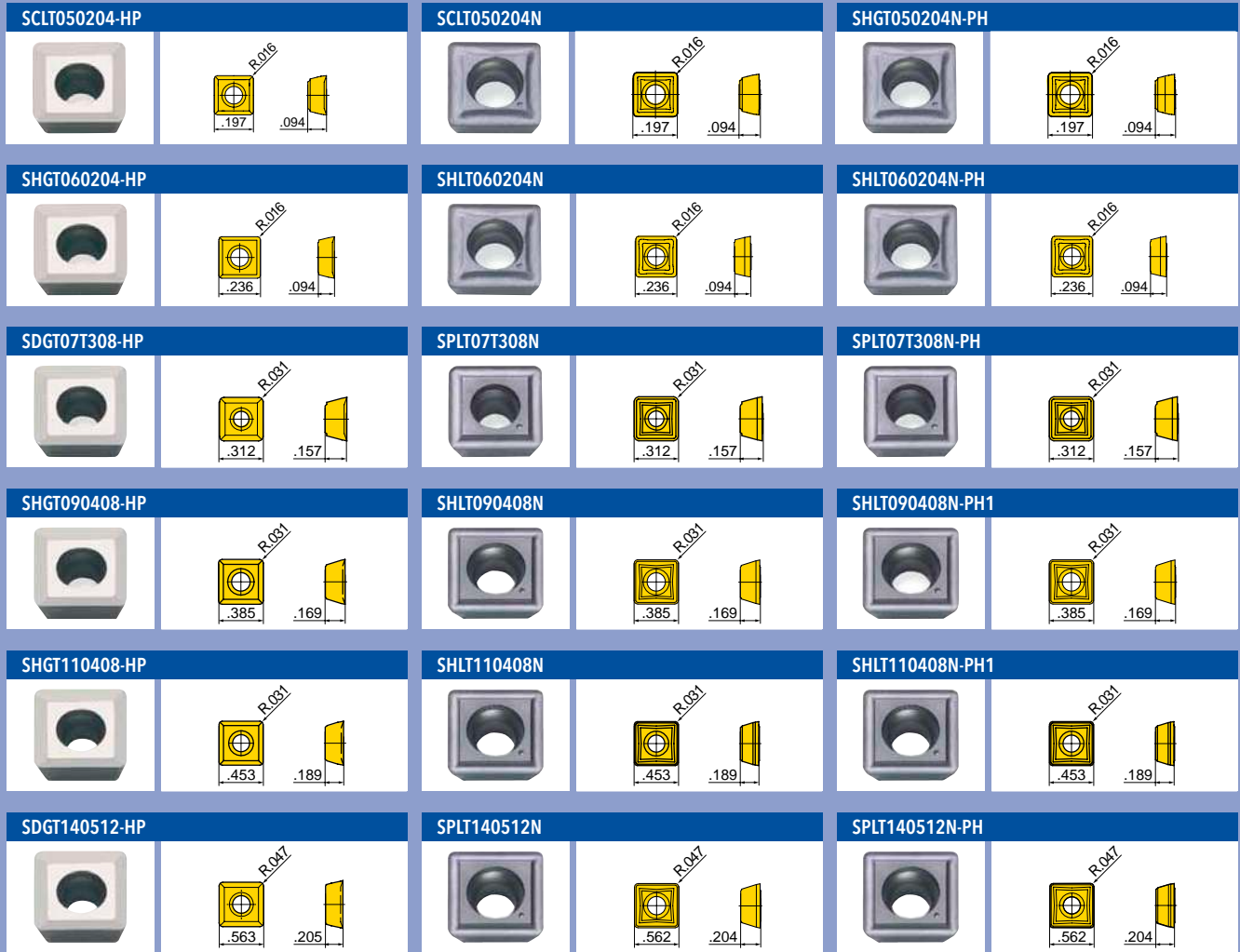

Drill Diameter	Part Number	Applications	Grade								
			IN1030	IN10K	IN2005	IN2010	IN6520				
.625	SCLT050204N	Cast Iron - 0.016" R									
.625	SCLT050204N-PH	Multi-Purpose - 0.015" R	●				●		●		
.625	SHGT050204-HP	Grd/Pol for Al - 0.016" R		●							
.688-.813	SHGT060204-HP	Grd/Pol for Al - 0.016" R		●							
.688-.813	SHLT060204N	Cast Iron - 0.016" R								●	
.688-.813	SHLT060204N-PH	Multi-Purpose - 0.016" R	●						●		
.843-1.063, 2.000	SDGT07T308-HP	Grd/Pol for Al - 0.030" R		●							
.843-1.063, 2.000	SPLT07T308N	Cast Iron - 0.030" R								●	
.843-1.063, 2.000	SPLT07T308N-PH	Multi-Purpose - 0.030" R	●						●		
1.094-1.312	SHGT090408-HP	Grd/Pol for Al - 0.030" R		●							
1.094-1.312	SHLT090408N	Cast Iron - 0.030" R								●	
1.094-1.312	SHLT090408N-PH1	Multi-Purpose - 0.030" R	●						●		
1.343-1.625	SHGT110408-HP	Grd/Pol for Al - 0.030" R		●							
1.343-1.625	SHLT110408N	Cast Iron - 0.030" R								●	
1.343-1.625	SHLT110408N-PH1	Multi-Purpose - 0.030" R	●						●		
1.687-1.937	SDGT140512-HP	Grd/Pol for Al - 0.047" R		●							
1.687-1.937	SPLT140512N	Cast Iron - 0.047" R								●	
1.687-1.937	SPLT140512N-PH	Multi-Purpose - 0.047" R	●						●		

● = P ● = M ● = K ● = N ● = S

QUAD-DRILL⁺ SERIES BU ECCENTRIC ADJUSTMENT BUSHINGS

ECCENTRIC ADJUSTMENT BUSHINGS

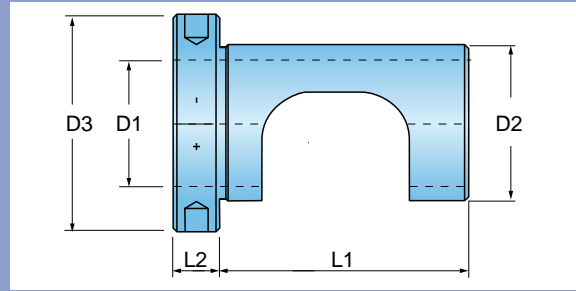

Part Number	D1 Shank Diameter	D2 Outside Diameter	D3 Flange Diameter	L1 Overall Length	L2 Flange Length
BU-16-16	1.000	1.250	1.750	2.00	0.38
BU-24-44	1.250	1.500	2.000	2.10	0.38
BU-32-02	1.500	2.000	2.500	2.44	0.38

CENTER-CUTTING COUNTER BORE TOOLS

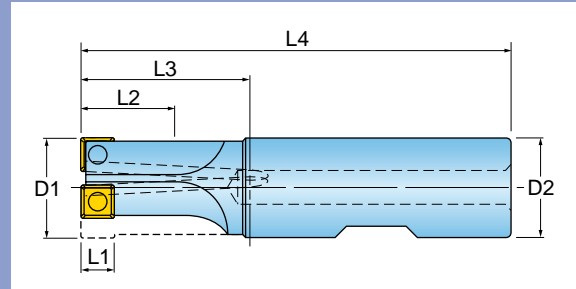

Part Number	D1 Nom. Dia. inch	D1 Nom. Dia. mm	L1 Cutting Edge	L2 Max C'bore Depth	L3 Ext. frm Holder	L4 Overall Length	D2 Shank Style/Size	Num of Inserts
1551D-0500884R01	0.500	12.7mm	0.22	0.50	0.88	2.85	.750" Weldon	1
1551D-0601084R01	0.625	15.8mm	0.22	0.62	1.00	2.97	.750" Weldon	2
1551D-0701084R01	0.719	18.2mm	0.22	0.72	1.00	2.97	.750" Weldon	2
1551D-0701284R01	0.750	19.0mm	0.22	0.75	1.25	3.22	.750" Weldon	2
1551G-0801284R01	0.813	20.6mm	0.40	0.75	1.25	3.25	.750" Weldon	1
1551G-0801284R02	0.844	21.4mm	0.40	0.75	1.25	3.25	.750" Weldon	1
1551F-1001580R01	1.000	25.4mm	0.33	1.00	1.50	3.69	1.000" Weldon	2
1551G-1102080R01	1.187	30.1mm	0.40	1.18	2.00	4.25	1.000" Weldon	2
1551G-1202080R01	1.250	31.7mm	0.40	1.25	2.00	4.25	1.000" Weldon	2
1551G-1302281R01	1.375	34.9mm	0.40	1.38	2.25	4.50	1.250" Weldon	2
1551G-1502281R01	1.500	38.1mm	0.40	1.50	2.25	4.50	1.250" Weldon	2
1551J-1602381R01	1.625	41.2mm	0.53	1.63	2.38	4.63	1.250" Weldon	2
1551J-1702681R01	1.750	44.4mm	0.53	1.75	2.62	4.82	1.250" Weldon	2
1551J-2003081R01	2.000	50.8mm	0.53	2.00	3.00	5.61	1.250" Weldon	2

Operating guidelines on [page 691](#).

HARDWARE

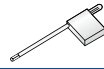

1551D-0500884R01	SM22-052-00	-	DS-T07F
1551D-0601084R01	SM22-052-00	-	DS-T07F
1551D-0701084R01	SM22-052-00	-	DS-T07F
1551D-0701284R01	SM22-052-00	-	DS-T07F
1551G-0801284R01	SM40-080-30	DS-T15T	-
1551G-0801284R02	SM40-080-30	DS-T15T	-
1551F-1001580R01	SM40-080-30	DS-T15T	-
1551G-1102080R01	SM40-093-20	DS-T15T	-
1551G-1202080R01	SM40-093-20	DS-T15T	-
1551G-1302281R01	SM40-093-20	DS-T15T	-
1551G-1502281R01	SM40-093-20	DS-T15T	-
1551J-1602381R01	SM50-127-10	DS-T20T	-
1551J-1702681R01	SM50-127-10	DS-T20T	-
1551J-2003081R01	SM50-127-10	DS-T20T	-

Insert Loading: Insert Series R

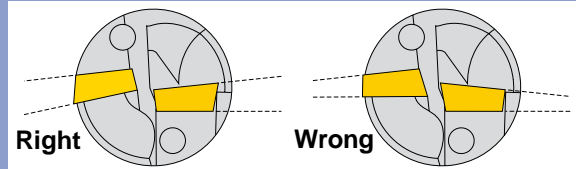

Series R inserts have only two cutting edges and must be loaded into the pockets properly or damage to the tool may result.

Optional Inserts



Insert Series SHLT110408TN-HR & SHLT140508TN-HR for End Milling. Series 15C1G, 15C1J, 15S1G and 15S1TJ can use optional insert Series SHLT110408TN-HR & SHLT140508TN-HR. These inserts include a chipbreaker designed to enhance chip formation when end milling. Do not use Series SHLT110408TN-HR or SHLT140508TN-HR inserts for counterboring applications.

INSERTS



Drill Diameter		Part Number	Applications	Grade	IN1030	IN1040	IN1530	IN2005	IN30M	IN40P	IN6515	IN6530
inch	mm											
.500 to .750	11.1 to 19.0	SPLIT060204R	Multi-Purpose - 0.016" R		●	●			●			
.500 to .750	11.1 to 19.0	SPLIT060204R-DM04	Multi-Purpose - 0.016" R		●							
1.000	25.4	SHLT090408N-FS	Heavy-Duty - 0.031" R		●			●			●	
1.000	25.4	SHLT090408N-PH	Positive Geometry - 0.031" R		●			●				
1.000	25.4	SHLT090416N-FS	Heavy-Duty - 0.062" R			●						
.813 to .844	20.7 to 21.4	SHLT110408N-FS	Heavy-Duty - 0.031" R		●			●			●	
.813 to .844	20.7 to 21.4	SHLT110408N-PH	Positive Geometry - 0.031" R					●				
.813 to .844	20.7 to 21.4	SHLT110408TN-HR	Multi-Purpose - 0.031" R		●			●	●			●
.813 to .844	20.7 to 21.4	SHLT110416N-FS	Heavy-Duty - 0.062" R		●							
1.187 to 1.500	30.1 to 38.1	SHLT110408N-FS	Heavy-Duty - 0.031" R		●			●			●	
1.187 to 1.500	30.1 to 38.1	SHLT110408N-PH	Positive Geometry - 0.031" R					●				
1.187 to 1.500	30.1 to 38.1	SHLT110408TN-HR	Multi-Purpose - 0.031" R		●			●	●			●
1.187 to 1.500	30.1 to 38.1	SHLT110416N-FS	Heavy-Duty - 0.062" R		●							
1.625 to 2.000	41.2 to 50.8	SHLT140508N-FS	Heavy-Duty - 0.031" R		●			●			●	
1.625 to 2.000	41.2 to 50.8	SHLT140508N-PH	Positive Geometry - 0.031" R					●				
1.625 to 2.000	41.2 to 50.8	SHLT140508TN-HR	Multi-Purpose - 0.031" R		●			●	●			●
1.625 to 2.000	41.2 to 50.8	SHLT140516N-FS	Heavy-Duty - 0.062" R		●						●	

DM04 Series: Designed with 4 cutting edges and is suitable for use in all materials.

R Series: Designed with 2 cutting edges for use in materials such as steels, cast irons, stainless, carbon and alloyed steels.

PS Series: Designed with 4 cutting edges for use in materials that tend to drill easily but are too malleable to break.

FS Series: Designed with 4 cutting edges for use in materials such as steels, cast irons, stainless, carbon and alloyed steels.

PH Series: Designed with 4 cutting edges for use in materials such as steels, cast irons, stainless, carbon, alloyed steels, aluminum and high temp alloys.

HR Series: Designed with 4 cutting edges for use in materials such as steels, cast irons, stainless, carbon, alloyed steels, aluminum and high temp alloys.

● = P ● = M ● = K ● = N ● = S

INDEXABLE COUNTER BORING TOOLS

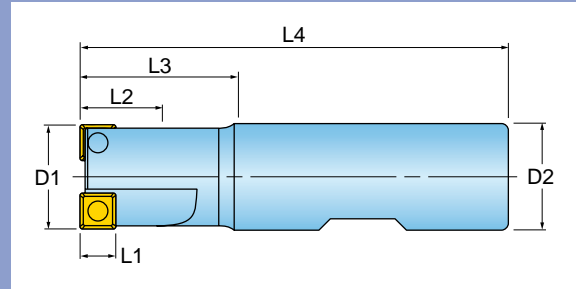

Part Number	D1 Nom. Dia. inch	D1 Nom. Dia. mm	L1 Cutting Edge	L2 Max C'bore Depth	L3 Ext. frm Holder	L4 Overall Length	D2 Shank Style/Size	Num of Inserts	Socket Head Cap Screw	Min. Cored Hole Dia.
15C1D-0400884R01	0.438	11.1mm	0.22	0.44	0.88	2.85	.750" Weldon	1	1/4	0.150
15C1D-0500884R01	0.531	13.4mm	0.22	0.53	0.88	2.85	.750" Weldon	1	5/16	0.230
15C1D-0601084R01	0.625	15.8mm	0.22	0.62	1.00	2.97	.750" Weldon	2	3/8	0.320
15C1D-0701084R01	0.719	18.2mm	0.22	0.72	1.00	2.97	.750" Weldon	2	7/16	0.420
15C1D-0701084R02	0.750	19.1mm	0.22	0.75	1.05	3.05	.750" Weldon	2	NA	0.450
15C1E-0801284R01	0.812	20.6mm	0.28	0.81	1.25	3.25	.750" Weldon	2	1/2	0.250
15C1E-0801384R01	0.875	22.2mm	0.28	0.88	1.38	3.38	.750" Weldon	2	NA	0.480
15C1G-1001580R01	1.000	25.4mm	0.40	1.00	1.50	3.75	1.000" Weldon	2	5/8	0.250
15C1G-1102080R01	1.187	30.1mm	0.40	1.18	2.00	4.25	1.000" Weldon	2	3/4	0.437
15C1G-1202080R01	1.250	31.7mm	0.40	1.25	2.00	4.25	1.000" Weldon	2	NA	0.500
15C1G-1302281R01	1.375	34.9mm	0.40	1.38	2.25	4.50	1.250" Weldon	3	NA	0.625
15C1G-1502281R01	1.500	38.1mm	0.40	1.50	2.25	4.50	1.250" Weldon	3	NA	0.750
15C1G-1503781R01	1.500	38.1mm	0.40	1.00	3.75	6.00	1.250" Weldon	3	NA	0.750
15C1G-1602581R01	1.625	41.3mm	0.40	1.63	2.50	4.75	1.250" Weldon	3	NA	0.810
15C1J-1702681R01	1.750	44.4mm	0.53	1.75	2.62	4.82	1.250" Weldon	2	NA	0.880
15C1J-2003081R01	2.000	50.8mm	0.53	2.00	3.00	5.25	1.250" Weldon	4	NA	1.120

Operating guidelines on [page 692](#).

HARDWARE

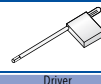

Part Number	Screw	Driver	Driver
15C1D-0400884R01	SM22-037-00	-	DS-T07F
15C1D-0500884R01	SM22-052-00	-	DS-T07F
15C1D-0601084R01	SM22-052-00	-	DS-T07F
15C1D-0701084R01	SM22-052-00	-	DS-T07F
15C1D-0701084R02	SM22-052-00	-	DS-T07F
15C1E-0801284R01	SM30-065-00	-	DS-T09W
15C1E-0801384R01	SM30-065-00	-	DS-T09W
15C1G-1001580R01	SM40-093-20	DS-T15T	-
15C1G-1102080R01	SM40-093-20	DS-T15T	-
15C1G-1202080R01	SM40-093-20	DS-T15T	-
15C1G-1302281R01	SM40-093-20	DS-T15T	-
15C1G-1502281R01	SM40-093-20	DS-T15T	-
15C1G-1503781R01	SM40-093-20	DS-T15T	-
15C1G-1602581R01	SM40-120-20	DS-T15T	-
15C1J-1702681R01	SM50-127-10	DS-T20T	-
15C1J-2003081R01	SM50-096-20	DS-T20T	-

Insert Loading: Insert Series R

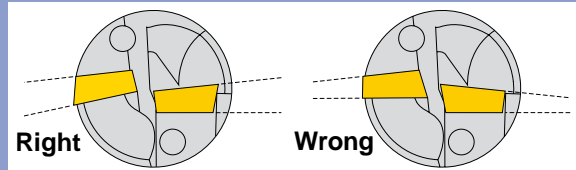

Series R inserts have only two cutting edges and must be loaded into the pockets properly or damage to the tool may result.

INSERTS

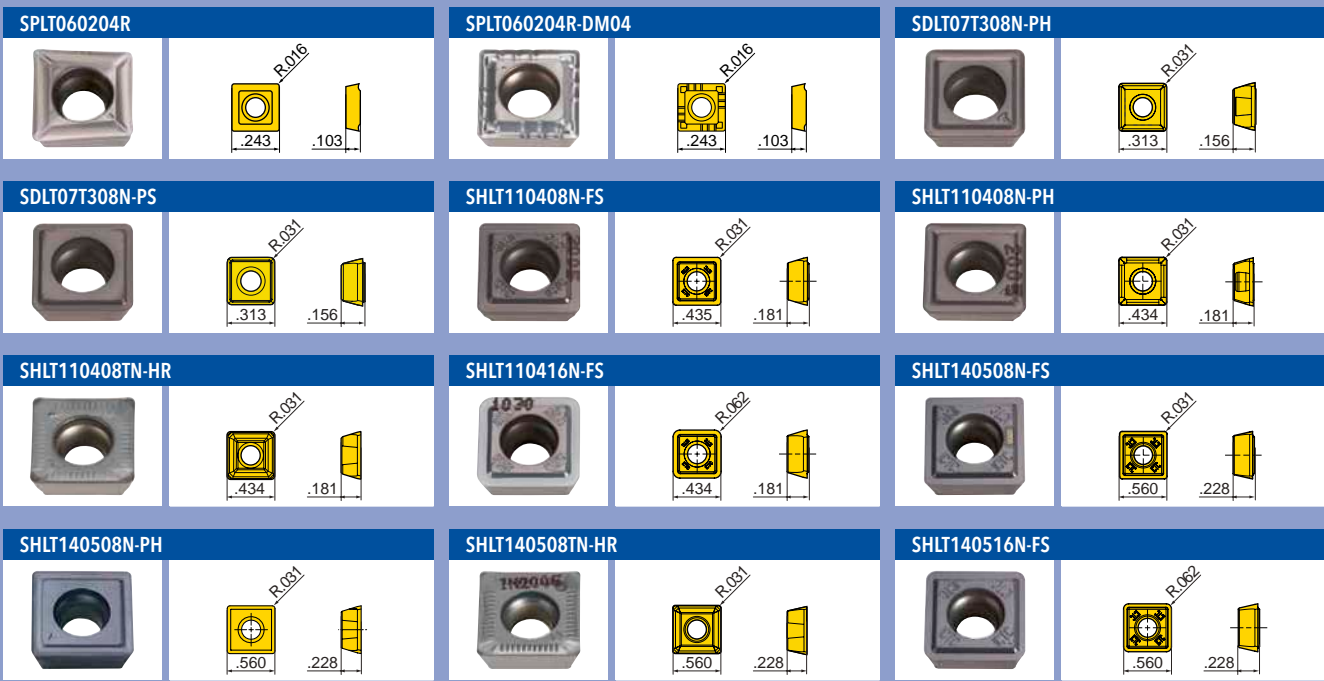

Drill Diameter inch	Drill Diameter mm	Part Number	Applications	Grade	IN1030	IN1040	IN2005	IN30M	IN40P	IN6515	IN6530
.438 to .750	11.1 to 19.05	SPLT060204R	Multi-Purpose - 0.015" R		●	●		●			
.438 to .750	11.1 to 19.05	SPLT060204R-DM04	Multi-Purpose - 0.015" R		●						
.812 to .875	20.6 to 22.2	SDLT07T308N-PH	Positive Geometry - 0.030" R				●				
.812 to .875	20.6 to 22.2	SDLT07T308N-PS	Hard to Break Chips - 0.030" R		●		●			●	
1.000 to 1.625	25.4 to 41.2	SHLT110408N-FS	Heavy-Duty - 0.031" R		●		●			●	
1.000 to 1.625	25.4 to 41.2	SHLT110408N-PH	Positive Geometry - 0.030" R				●				
1.000 to 1.625	25.4 to 41.2	SHLT110408TN-HR	Multi-Purpose - 0.031" R		●		●	●	●		●
1.000 to 1.625	25.4 to 41.2	SHLT110416N-FS	Heavy-Duty - 0.062" R		●					●	
1.750 to 2.000	44.4 to 50.8	SHLT140508N-FS	Heavy-Duty - 0.031" R		●		●			●	
1.750 to 2.000	44.4 to 50.8	SHLT140508N-PH	Positive Geometry - 0.030" R				●				
1.750 to 2.000	44.4 to 50.8	SHLT140508TN-HR	Multi-Purpose - 0.031" R		●		●	●	●		●
1.750 to 2.000	44.4 to 50.8	SHLT140516N-FS	Heavy-Duty - 0.062" R		●		●			●	

DM04 Series: Designed with 4 cutting edges and is suitable for use in all materials. ● = P ● = M ● = K ● = N ● = S

R Series: Designed with 2 cutting edges for use in materials such as steels, cast irons, stainless, carbon and alloyed steels.

PS Series: Designed with 4 cutting edges for use in materials that tend to drill easily but are too malleable to break.

FS Series: Designed with 4 cutting edges for use in materials such as steels, cast irons, stainless, carbon and alloyed steels.

PH Series: Designed with 4 cutting edges for use in materials such as steels, cast irons, stainless, carbon, alloyed steels, aluminum and high temp alloys.

HR Series: Designed with 4 cutting edges for use in materials such as steels, cast irons, stainless, carbon, alloyed steels, aluminum and high temp alloys.

Optional Inserts



Insert Series SHLT110408TN-HR & SHLT140508TN-HR for End Milling. Series 15C1G, 15C1J, 15S1G and 15S1TJ can use optional insert Series SHLT110408TN-HR & SHLT140508TN-HR. These inserts include a chipbreaker designed to enhance chip formation when end milling. Do not use Series SHLT110408TN-HR or SHLT140508TN-HR inserts for counterboring applications.

QWIK REAM SHANKS - INCH

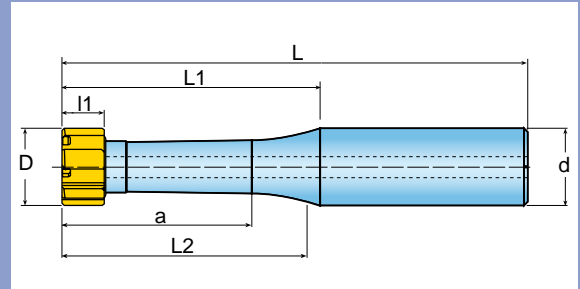

Designation	BN Range	L:D	Diameter Range (inch/mm)	Adaption	S (inch)	L (inch)	L1 (inch)	Shank Material
XS5044133S6R01	BN5	3X	.453-.531 (11.5-13.5mm)	.625" Cylindrical	0.366	3.850	1.960	Steel
XS5044222S6R01	BN5	5X	.453-.531 (11.5-13.5mm)	.625" Cylindrical	0.366	4.920	3.030	Steel
XS5044355S6R01	BN5	8X	.453-.531 (11.5-13.5mm)	.625" Cylindrical	0.366	6.520	4.630	Steel
XS6053226S6R01	BN6	3X	.531-.630 (13.501-16mm)	.625" Cylindrical	0.370	4.150	2.260	Steel
XS6053350S6R01	BN6	5X	.531-.630 (13.501-16mm)	.625" Cylindrical	0.370	6.520	5.410	Steel
XS6053540S6R01	BN6	8X	.531-.630 (13.501-16mm)	.625" Cylindrical	0.370	7.300	5.410	Steel
XS7063278S7R01	BN7	3X	.630-.787 (16.001-20mm)	.750" Cylindrical	0.417	4.740	2.780	Steel
XS7063433S7R01	BN7	5X	.630-.787 (16.001-20mm)	.750" Cylindrical	0.417	6.320	4.350	Steel
XS7063670S7R01	BN7	8X	.630-.787 (16.001-20mm)	.750" Cylindrical	0.417	8.690	6.720	Steel
XS8079331S7R01	BN8	3X	.787-1.0 (20.001-25.4mm)	.750" Cylindrical	0.504	5.280	3.310	Steel
XS8079531S7R01	BN8	5X	.787-1.0 (20.001-25.4mm)	.750" Cylindrical	0.504	7.390	5.430	Steel
XS8079841S7R01	BN8	8X	.787-1.0 (20.001-25.4mm)	.750" Cylindrical	0.504	10.350	8.380	Steel
XS9250076S9R01	BN9	3X	1.000-1.260 (26-32mm)	1.250" Cylindrical	0.504	6.580	4.220	Steel
XS9250127S9R01	BN9	5X	1.000-1.260 (26-32mm)	1.250" Cylindrical	0.504	9.100	6.740	Steel
XS9250203S9R01	BN9	8X	1.000-1.260 (26-32mm)	1.250" Cylindrical	0.504	12.880	10.520	Steel

For heads, see [pages 544 - 547](#).
Operating guidelines on [page 694](#).

HARDWARE



Clamping Key



Bayonet Screw

XS5044133S6R01	TM-B5-KEY	TM-B5-SCR
XS5044222S6R01	TM-B5-KEY	TM-B5-SCR
XS5044355S6R01	TM-B5-KEY	TM-B5-SCR
XS6053226S6R01	TM-B6-KEY	TM-B6-SCR
XS6053350S6R01	TM-B6-KEY	TM-B6-SCR
XS6053540S6R01	TM-B6-KEY	TM-B6-SCR
XS7063278S7R01	TM-B7-KEY	TM-B7-SCR
XS7063433S7R01	TM-B7-KEY	TM-B7-SCR
XS7063670S7R01	TM-B7-KEY	TM-B7-SCR
XS8079331S7R01	TM-B8-KEY	TM-B8-SCR
XS8079531S7R01	TM-B8-KEY	TM-B8-SCR
XS8079841S7R01	TM-B8-KEY	TM-B8-SCR
XS9250076S9R01	TM-B9-KEY	TM-B9-SCR
XS9250127S9R01	TM-B9-KEY	TM-B9-SCR
XS9250203S9R01	TM-B9-KEY	TM-B9-SCR

QWIK REAM SHANKS - METRIC

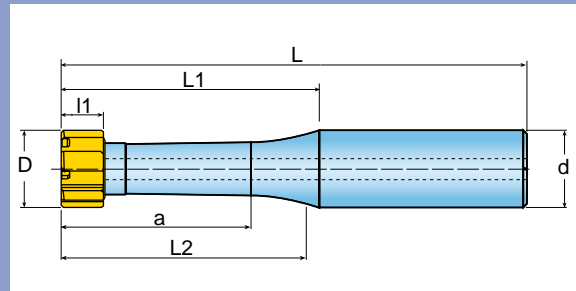

Designation	BN Range	L:D	Diameter Range (mm/inch)	Adaption	S (mm)	L (mm)	L1 (mm)	Shank Material
XS5044133T3R01	BN5	3X	11.5-13.5mm (.453-.531")	16mm Cylindrical	9.3mm	97.8mm	49.8mm	Steel
XS5044222T3R01	BN5	5X	11.5-13.5mm (.453-.531")	16mm Cylindrical	9.3mm	125.0mm	77.0mm	Steel
XS5044355T3R01	BN5	8X	11.5-13.5mm (.453-.531")	16mm Cylindrical	9.3mm	165.5mm	117.5mm	Steel
XS6053540T3R01	BN6	3X	13.501-16mm (.531-.630")	16mm Cylindrical	9.4mm	185.4mm	137.4mm	Steel
XS6135057T3R01	BN6	5X	13.501-16mm (.531-.630")	16mm Cylindrical	9.4mm	105.5mm	57.5mm	Steel
XS6135089T3R01	BN6	8X	13.501-16mm (.531-.630")	16mm Cylindrical	9.4mm	137.4mm	89.4mm	Steel
XS7063670T4R01	BN7	3X	16.001-20mm (.630-.787")	20mm Cylindrical	10.6mm	220.6mm	170.6mm	Steel
XS7160070T4R01	BN7	5X	16.001-20mm (.630-.787")	20mm Cylindrical	10.6mm	120.5mm	70.5mm	Steel
XS7160110T4R01	BN7	8X	16.001-20mm (.630-.787")	20mm Cylindrical	10.6mm	160.6mm	110.6mm	Steel
XS8079841T4R01	BN8	3X	20.001-25.4mm (.787-1.0")	20mm Cylindrical	12.8mm	262.8mm	212.0mm	Steel
XS8200084T4R01	BN8	5X	20.001-25.4mm (.787-1.0")	20mm Cylindrical	12.8mm	137.8mm	87.8mm	Steel
XS8200135T4R01	BN8	8X	20.001-25.4mm (.787-1.0")	20mm Cylindrical	12.8mm	187.8mm	137.8mm	Steel
XS9250127U7R01	BN9	3X	26-32mm (1.000-1.260")	32mm Cylindrical	12.8mm	167.1mm	107.1mm	Steel
XS9250127U7R01	BN9	5X	26-32mm (1.000-1.260")	32mm Cylindrical	12.8mm	231.1mm	171.1mm	Steel
XS9250203U7R01	BN9	8X	26-32mm (1.000-1.260")	32mm Cylindrical	12.8mm	327.1mm	267.1mm	Steel

For heads, see pages 544 - 547.
Operating guidelines on page 694.

HARDWARE



Clamping Key



Bayonet Screw

XS5044133T3R01	TM-B5-KEY	TM-B5-SCR
XS5044222T3R01	TM-B5-KEY	TM-B5-SCR
XS5044355T3R01	TM-B5-KEY	TM-B5-SCR
XS6053540T3R01	TM-B6-KEY	TM-B6-SCR
XS6135057T3R01	TM-B6-KEY	TM-B6-SCR
XS6135089T3R01	TM-B6-KEY	TM-B6-SCR
XS7063670T4R01	TM-B7-KEY	TM-B7-SCR
XS7160070T4R01	TM-B7-KEY	TM-B7-SCR
XS7160110T4R01	TM-B7-KEY	TM-B7-SCR
XS8079841T4R01	TM-B8-KEY	TM-B8-SCR
XS8200084T4R01	TM-B8-KEY	TM-B8-SCR
XS8200135T4R01	TM-B8-KEY	TM-B8-SCR
XS9250127U7R01	TM-B9-KEY	TM-B9-SCR
XS9250127U7R01	TM-B9-KEY	TM-B9-SCR
XS9250203U7R01	TM-B9-KEY	TM-B9-SCR



CARBIDE REAMING HEAD FOR THRU HOLES - INCH

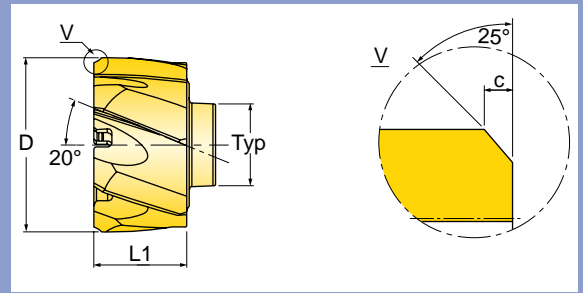

Designation	BN Range	Diameter (inch)	Flute Type	Front End Code	
XLB12700R71	IN2005	BN5	0.500	LH	B
XLB15875R71	IN2005	BN6	0.625	LH	B
XLB19050R71	IN2005	BN7	0.750	LH	B
XLB22225R71	IN2005	BN8	0.875	LH	B
XLB25400R71	IN2005	BN8	1.000	LH	B
XLB31750R71	IN2005	BN9	1.250	LH	B

For shanks, see [pages 542 and 543](#).
 Operating guidelines on [page 694](#).

CARBIDE REAMING HEAD FOR THRU HOLES - METRIC

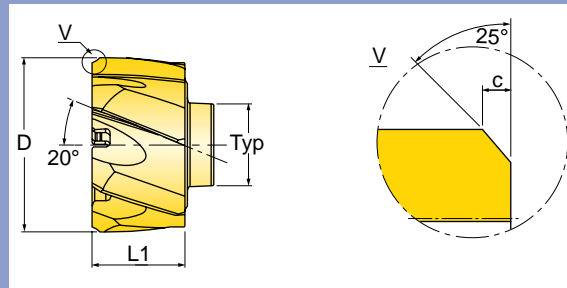

Designation	BN Range	Diameter (mm)	Flute Type	Front End Code	
XLB12000R71	IN2005	BN5	12.000mm	LH	B
XLB13000R71	IN2005	BN5	13.000mm	LH	B
XLB13501R71	IN2005	BN6	13.501mm	LH	B
XLB14000R71	IN2005	BN6	14.000mm	LH	B
XLB15000R71	IN2005	BN6	15.000mm	LH	B
XLB16000R71	IN2005	BN6	16.000mm	LH	B
XLB16001R71	IN2005	BN7	16.001mm	LH	B
XLB17000R71	IN2005	BN7	17.000mm	LH	B
XLB18000R71	IN2005	BN7	18.000mm	LH	B
XLB19000R71	IN2005	BN7	19.000mm	LH	B
XLB20000R71	IN2005	BN7	20.000mm	LH	B
XLB20001R71	IN2005	BN8	20.001mm	LH	B
XLB21000R71	IN2005	BN8	21.000mm	LH	B
XLB22000R71	IN2005	BN8	22.000mm	LH	B
XLB23000R71	IN2005	BN8	23.000mm	LH	B
XLB24000R71	IN2005	BN8	24.000mm	LH	B
XLB25000R71	IN2005	BN8	25.000mm	LH	B
XLB26000R71	IN2005	BN9	26.000mm	LH	B
XLB27000R71	IN2005	BN9	27.000mm	LH	B
XLB28000R71	IN2005	BN9	28.000mm	LH	B
XLB29000R71	IN2005	BN9	29.000mm	LH	B
XLB30000R71	IN2005	BN9	30.000mm	LH	B
XLB31000R71	IN2005	BN9	31.000mm	LH	B
XLB32000R71	IN2005	BN9	32.000mm	LH	B

For shanks, see [pages 542 and 543](#).
Operating guidelines on [page 694](#).

CARBIDE REAMING HEAD FOR BLIND HOLES - INCH

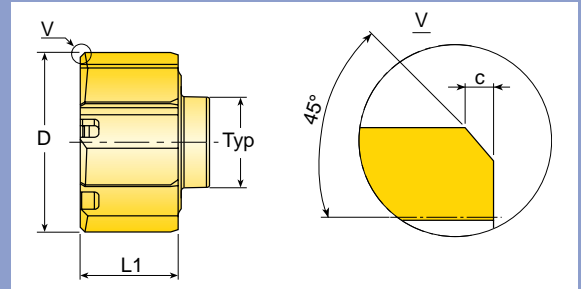

Designation	BN Range	Diameter (inch)	Flute Type	Front End Code	
XSA12700R71	IN2005	BN5	0.500	ST	A
XSA15875R01	IN2005	BN6	0.625	ST	A
XSA19050R01	IN2005	BN7	0.750	ST	A
XSA22225R01	IN2005	BN8	0.875	ST	A
XSA25400R01	IN2005	BN8	1.000	ST	A
XSA31750R71	IN2005	BN9	1.250	ST	A

For shanks, see [pages 542 and 543](#).
Operating guidelines on [page 694](#).

CARBIDE REAMING HEAD FOR BLIND HOLES

- METRIC

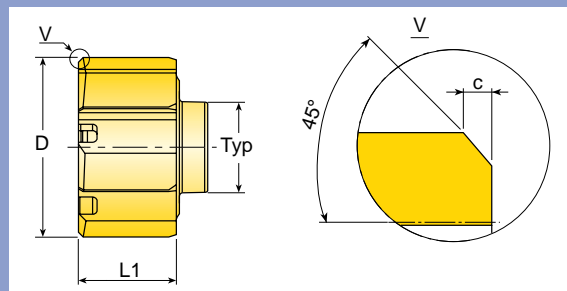

Designation	BN Range	Diameter (mm)	Flute Type	Front End Code	
XSA12000R71	IN2005	BN5	12.000mm	ST	A
XSA13000R71	IN2005	BN5	13.000mm	ST	A
XSA13501R01	IN2005	BN6	13.501mm	ST	A
XSA14000R01	IN2005	BN6	14.000mm	ST	A
XSA15000R01	IN2005	BN6	15.000mm	ST	A
XSA16000R01	IN2005	BN6	16.000mm	ST	A
XSA16001R01	IN2005	BN7	16.001mm	ST	A
XSA17000R01	IN2005	BN7	17.000mm	ST	A
XSA18000R01	IN2005	BN7	18.000mm	ST	A
XSA19000R01	IN2005	BN7	19.000mm	ST	A
XSA20000R01	IN2005	BN7	20.000mm	ST	A
XSA20001R01	IN2005	BN8	20.001mm	ST	A
XSA21000R01	IN2005	BN8	21.000mm	ST	A
XSA22000R01	IN2005	BN8	22.000mm	ST	A
XSA23000R01	IN2005	BN8	23.000mm	ST	A
XSA24000R01	IN2005	BN8	24.000mm	ST	A
XSA25000R01	IN2005	BN8	25.000mm	ST	A
XSA26000R71	IN2005	BN9	26.000mm	ST	A
XSA27000R71	IN2005	BN9	27.000mm	ST	A
XSA28000R71	IN2005	BN9	28.000mm	ST	A
XSA29000R71	IN2005	BN9	29.000mm	ST	A
XSA30000R71	IN2005	BN9	30.000mm	ST	A
XSA31000R71	IN2005	BN9	31.000mm	ST	A
XSA32000R71	IN2005	BN9	32.000mm	ST	A

For shanks, see [pages 542 and 543](#).
Operating guidelines on [page 694](#).

SOLID CARBIDE THREAD MILLS - INTERNAL THREAD MILLS FOR UN THREAD

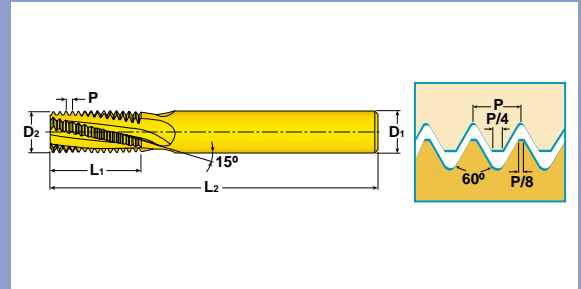

Cutter Number		P Pitch (TPI)			Shank Style/Size	D2 Thread	No. of Flutes	L1 Extension Length	L2 Overall Length	
		UNC	UNF	UNEF						
46Y-40UNR6RA060	IN2005	40	5	NA	-	.250" Cylindrical	0.098	3	0.240	2.5
46Y-32UNR6RA060	IN2005	32	8	10	12	.250" Cylindrical	0.126	3	0.270	2.5
46Y-28UNR6RA100	IN2005	28	-	1/4	-	.250" Cylindrical	0.157	3	0.450	2.5
46Y-28UNR6RA140	IN2005	28	-	-	7/16-1/2	.250" Cylindrical	0.236	3	0.570	2.5
46Y-24UNR6RA150	IN2005	24	-	5/16-3/8	-	.250" Cylindrical	0.197	3	0.560	2.5
46Y-24UNR7RA200	IN2005	24	-	NA	9/16-5/8	.312" Cylindrical	0.276	3	0.810	2.5
46Y-20UNR6RA120	IN2005	20	1/4	-	-	.250" Cylindrical	0.177	3	0.480	2.5
46Y-20UNR7RA200	IN2005	20	-	7/16-1/2	-	.312" Cylindrical	0.276	3	0.830	2.5
47Y-20UNS4RA280	IN2005	20	-	-	3/4-1	.500" Cylindrical	0.472	5	1.080	3.5
46Y-18UNR6RA150	IN2005	18	5/16	-	-	.250" Cylindrical	0.197	3	0.580	2.5
47Y-18UNR8RA250	IN2005	18	-	9/16-5/8	11/8-15/8	.375" Cylindrical	0.375	4	1.030	3
46Y-16UNR6RA180	IN2005	16	3/8	-	-	.250" Cylindrical	0.236	3	0.660	2.5
47Y-16UNS4RA300	IN2005	16	-	3/4	-	.500" Cylindrical	0.472	4	1.220	3.5
46Y-14UNR7RA200	IN2005	14	7/16	-	-	.312" Cylindrical	0.276	3	0.820	2.5
47Y-14UNS6RA380	IN2005	14	-	7/8	-	.625" Cylindrical	0.591	5	1.460	4
46Y-13UNR7RA230	IN2005	13	1/2	-	-	.312" Cylindrical	0.313	3	0.880	2.5
46Y-12UNR8RA250	IN2005	12	9/16	-	-	.375" Cylindrical	0.375	3	1.040	3
47Y-12UNS6RA410	IN2005	12	-	1-11/2	-	.625" Cylindrical	0.625	5	1.630	4
46Y-11UNR8RA270	IN2005	11	5/8	-	-	.375" Cylindrical	0.375	3	1.140	3
46Y-10UNS4RA350	IN2005	10	3/4	-	-	.500" Cylindrical	0.472	3	1.350	3.5
46Y-09UNS6RA380	IN2005	09	7/8	-	-	.625" Cylindrical	0.591	3	1.500	4
46Y-08UNS6RA430	IN2005	08	1	-	-	.625" Cylindrical	0.625	3	1.690	4
47Y-07UNS7RA450	IN2005	07	11/8-11/4	-	-	.750" Cylindrical	0.750	4	1.780	4

Operating guidelines on [page 704](#).

RAPID THREAD SERIES 46Y_IS_RA, 47Y_IS_RA

SOLID CARBIDE THREAD MILLS - INTERNAL THREAD MILLS FOR ISO THREAD

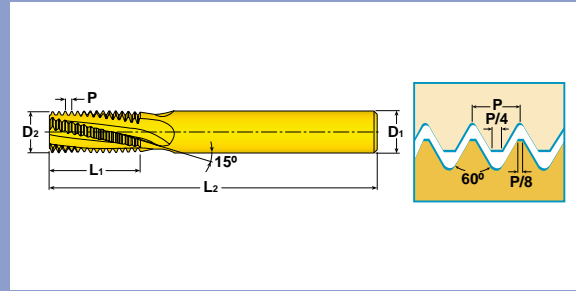
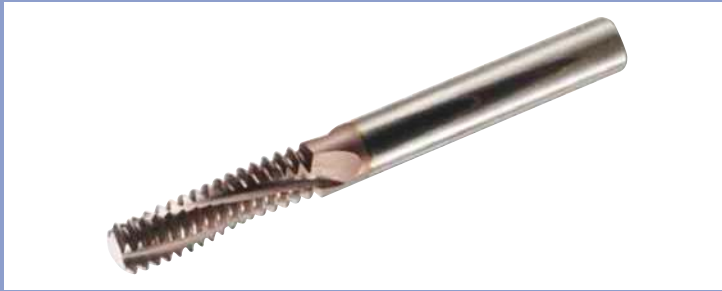

Cutter Number	P Pitch (mm)	Thread Size	Shank Style/Size	D2 Thread	No. of Flutes	L1 Extension Length	L2 Overall Length	
46Y050ISR6RA050	IN2005	0.500	M03	.250" Cylindrical	0.087	3	0.210	2.5
46Y050ISR6RA100	IN2005	0.500	-	.250" Cylindrical	0.150	3	0.410	2.5
46Y070ISR6RA070	IN2005	0.700	M04	.250" Cylindrical	0.122	3	0.290	2.5
46Y075ISR6RA100	IN2005	0.750	-	.250" Cylindrical	0.177	3	0.400	2.5
46Y080ISR6RA090	IN2005	0.800	M05	.250" Cylindrical	0.142	3	0.360	2.5
46Y100ISR6RA100	IN2005	1.000	M06	.250" Cylindrical	0.157	3	0.410	2.5
46Y100ISR6RA140	IN2005	1.000	M06	.250" Cylindrical	0.157	3	0.570	2.5
46Y100ISR6RA130	IN2005	1.000	-	.250" Cylindrical	0.236	3	0.490	2.5
47Y100ISR7RA180	IN2005	1.000	-	.375" Cylindrical	0.313	4	0.650	2.5
46Y125ISR6RA150	IN2005	1.250	M08	.250" Cylindrical	0.197	3	0.570	2.5
46Y125ISR6RA190	IN2005	1.250	M08	.250" Cylindrical	0.197	3	0.760	2.5
46Y150ISR7RA180	IN2005	1.500	M10	.375" Cylindrical	0.276	3	0.680	2.5
46Y150ISR7RA250	IN2005	1.500	M10	.375" Cylindrical	0.276	3	0.980	2.5
47Y150ISR8RA230	IN2005	1.500	-	.375" Cylindrical	0.375	4	0.860	3
46Y175ISR7RA200	IN2005	1.750	M12	.312" Cylindrical	0.313	3	0.790	2.5
46Y175ISR7RA290	IN2005	1.750	M12	.312" Cylindrical	0.313	3	1.140	2.5
46Y200ISR8RA280	IN2005	2.000	M16	.375" Cylindrical	0.375	3	1.060	3
46Y200ISR8RA390	IN2005	2.000	M16	.375" Cylindrical	0.375	3	1.540	4
47Y200ISS4RA280	IN2005	2.000	-	.500" Cylindrical	0.472	4	1.060	3.5
48Y200ISS7RA410	IN2005	2.000	-	.750" Cylindrical	0.750	6	1.610	4
47Y250ISS6RA330	IN2005	2.500	M20	.625" Cylindrical	0.551	4	1.330	4
47Y250ISS6RA480	IN2005	2.500	M20	.625" Cylindrical	0.551	4	1.920	4
46Y300ISS6RA410	IN2005	3.000	M24	.625" Cylindrical	0.625	3	1.590	4
46Y300ISS6RA580	IN2005	3.000	M24	.625" Cylindrical	0.625	3	2.310	4.5
47Y300ISS7RA430	IN2005	3.000	M28	.750" Cylindrical	0.750	4	1.710	4

Operating guidelines on [page 704](#).



RAPID[®]THREAD SERIES 46Y_NTR, 47Y_NTS (NPT)

SOLID CARBIDE THREAD MILLS - FOR EXTERNAL OR INTERNAL NPT THREAD

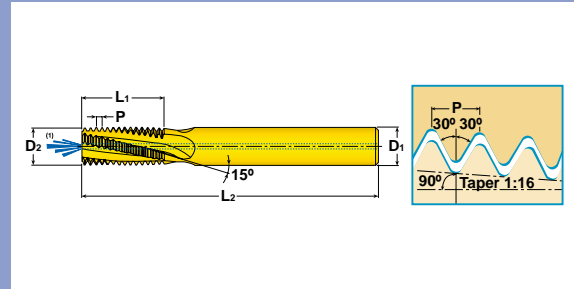

Cutter Number	Pitch (TPI)	Standard	D2 Shank Size/Style	D2 Thread	No. of Effective	L1	L2	
46Y-27NTR6RA100	IN2005	27	1/8	.250" Cylindrical	0.250	3	0.390	2.5
46Y-27NTR7RB110	IN2005	27	1/8	.250" Cylindrical	0.250	3	0.430	2.5
46Y-18NTR7RA150	IN2005	18	1/4-3/8	.312" Cylindrical	0.312	3	0.580	2.5
47Y-14NTS4RA200	IN2005	14	1/2-3/4	.500" Cylindrical	0.500	4	0.820	3.5
47Y-14NTS6RB230	IN2005	14	1/2-3/4	.500" Cylindrical	0.500	4	0.890	4
47Y-11NTS6RA280	IN2005	12	1-2	.625" Cylindrical	0.625	4	1.090	4
47Y-11NTS7RB300	IN2005	12	1-2	.625" Cylindrical	0.625	4	1.170	4
47Y-08NTS7RA410	IN2005	08	>=2-1/2	.750" Cylindrical	0.750	4	1.560	4

Operating guidelines on [page 704](#).

RAPID THREAD SERIES 46Y_NFR, 47Y_NFS (NPTF)

SOLID CARBIDE THREAD MILLS - FOR EXTERNAL OR INTERNAL NPTF THREAD



Coolant



Int. Thread



Ext. Thread

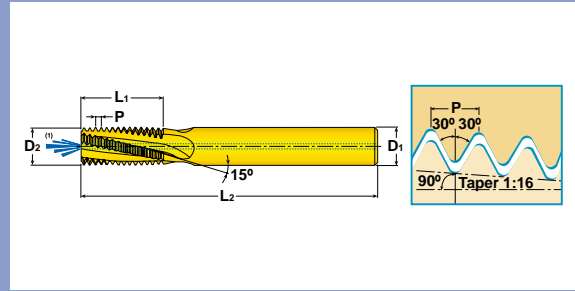

Cutter Number		Pitch (TPI)	Standard	D2 Shank Size/Style	D2 Thread	No. of Effective	L1	L2
46Y-27NFR6RA100	IN2005	27	1/8	.250" Cylindrical	0.250	3	0.390	2.5
46Y-27NFR7RB110	IN2005	27	1/8	.250" Cylindrical	0.250	3	0.430	2.5
46Y-18NFR7RA150	IN2005	18	1/4-3/8	.312" Cylindrical	0.312	3	0.580	2.5
47Y-14NFS4RA210	IN2005	14	1/2-3/4	.500" Cylindrical	0.500	4	0.820	3.5
47Y-14NFS6RB230	IN2005	14	1/2-3/4	.500" Cylindrical	0.500	4	0.890	4
47Y-11NFS6RA280	IN2005	12	1-2	.625" Cylindrical	0.625	4	1.090	4
47Y-11NFS7RB300	IN2005	12	1-2	.625" Cylindrical	0.625	4	1.170	4
47Y-08NFS7RA400	IN2005	08	>=2-1/2	.750" Cylindrical	0.750	4	1.560	4

Operating guidelines on [page 704](#).

SOLID CARBIDE THREAD MILLS - SMALL DIAMETER, SHORT, UN PROFILE, 2XD AND 3XD

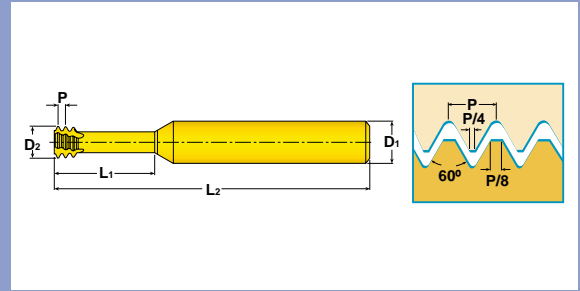

Cutter Number		P Pitch (TPI)		Shank Style/Size	D2 Thread	No. of Flutes	L1 Extension Length	L2 Overall Length	
		UNC	UNF						
46Y-80UNR6RM040	IN2005	80	-	0	.250" Cylindrical	0.045	3	0.160	2.5
46Y-72UNR6RM040	IN2005	72	-	1	.250" Cylindrical	0.057	3	0.150	2.5
46Y-64UNR6RM040	IN2005	64	1	2	.250" Cylindrical	0.055	3	0.150	2.5
46Y-56UNR6RM040	IN2005	56	2	3	.250" Cylindrical	0.065	3	0.170	2.5
46Y-48UNR6RM050	IN2005	48	3	4	.250" Cylindrical	0.075	3	0.200	2.5
46Y-40UNR6RM060	IN2005	40	4	-	.250" Cylindrical	0.083	3	0.250	2.5
46Y-40UNR6RM070	IN2005	40	5	6	.250" Cylindrical	0.096	3	0.280	2.5
46Y-40UNR6RM100	IN2005	40	5	6	.250" Cylindrical	0.096	3	0.380	2.5
46Y-36UNR6RM090	IN2005	36	-	8	.250" Cylindrical	0.130	3	0.350	2.5
46Y-32UNR6RM070	IN2005	32	6	-	.250" Cylindrical	0.100	3	0.280	2.5
46Y-32UNR6RM090	IN2005	32	8	-	.250" Cylindrical	0.126	3	0.370	2.5
46Y-32UNR6RM100	IN2005	32	-	10	.250" Cylindrical	0.146	3	0.410	2.5
46Y-32UNR6RM120	IN2005	32	8	-	.312" Cylindrical	0.126	3	0.490	2.5
46Y-32UNR6RM150	IN2005	32	-	10	.312" Cylindrical	0.146	3	0.590	2.5
46Y-28UNR6RM110	IN2005	28	-	12	.250" Cylindrical	0.165	3	0.430	2.5
46Y-28UNR6RM140	IN2005	28	-	1/4	.250" Cylindrical	0.197	3	0.570	2.5
46Y-28UNR6RM190	IN2005	28	-	1/4	.375" Cylindrical	0.197	3	0.750	2.5
46Y-24UNR6RM110	IN2005	24	10, 12	-	.250" Cylindrical	0.138	3	0.420	2.5
46Y-24UNR7RM170	IN2005	24	-	5/16	.250" Cylindrical	0.260	3	0.670	2.5
46Y-24UNR7RM160	IN2005	24	-	5/16	.500" Cylindrical	0.260	3	0.940	2.5
46Y-20UNR6RM140	IN2005	20	1/4	-	.250" Cylindrical	0.187	3	0.550	2.5
46Y-20UNR6RM190	IN2005	20	1/4	-	.500" Cylindrical	0.187	3	0.750	2.5
46Y-18UNR6RM170	IN2005	18	5/16	-	.250" Cylindrical	0.236	3	0.670	2.5
46Y-18UNR6RM230	IN2005	18	5/16	-	.625" Cylindrical	0.236	3	0.910	2.5
46Y-16UNR7RM220	IN2005	16	3/8	-	.250" Cylindrical	0.264	3	0.870	2.5
46Y-14UNR7RM250	IN2005	14	7/16	-	.250" Cylindrical	0.303	3	0.980	2.5
46Y-13UNR8RM270	IN2005	13	1/2	-	.250" Cylindrical	0.362	3	1.080	3
46Y-12UNS4RM310	IN2005	12	9/16	-	.250" Cylindrical	0.413	3	1.240	3.5
46Y-11UNS4RM350	IN2005	11	5/8	-	.250" Cylindrical	0.449	3	1.360	3.5
47Y-10UNS6RM410	IN2005	10	3/4	-	.312" Cylindrical	0.567	4	1.630	4

Operating guidelines on [page 704](#).

RAPID THREAD SERIES 46Y_IS_RM, 47Y_IS_RM

SOLID CARBIDE THREAD MILLS - SMALL DIAMETER, SHORT, ISO PROFILE, 2XD AND 3XD

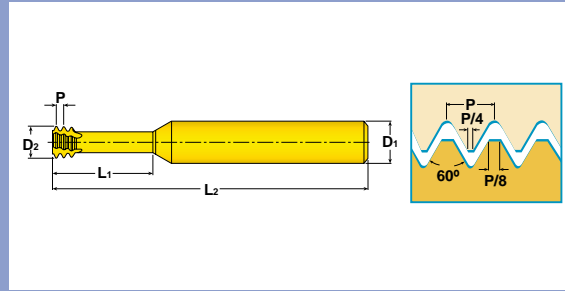

Cutter Number	P Pitch (mm)	Thread Size	Shank Style/Size	D2 Thread	No. of Flutes	L1 Extension Length	L2 Overall Length
46Y040ISR6RM050 IN2005	0.400	M02	.250" Cylindrical	0.061	3	0.180	2.5
46Y045ISR6RM050 IN2005	0.450	M02.2	.250" Cylindrical	0.065	3	0.200	2.5
46Y045ISR6RM060 IN2005	0.450	M02.5	.250" Cylindrical	0.077	3	0.220	2.5
46Y045ISR6RM080 IN2005	0.450	M02.5	.250" Cylindrical	0.077	3	0.300	2.5
46Y050ISR6RM070 IN2005	0.500	M03	.250" Cylindrical	0.093	3	0.260	2.5
46Y050ISR6RM090 IN2005	0.500	M03	.250" Cylindrical	0.093	3	0.370	2.5
46Y060ISR6RM080 IN2005	0.600	M03.5	.250" Cylindrical	0.108	3	0.300	2.5
46Y070ISR6RM090 IN2005	0.700	M04	.250" Cylindrical	0.122	3	0.350	2.5
46Y070ISR6RM120 IN2005	0.700	M04	.250" Cylindrical	0.122	3	0.490	2.5
46Y080ISR6RM120 IN2005	0.800	M05	.250" Cylindrical	0.150	3	0.490	2.5
46Y080ISR6RM160 IN2005	0.800	M05	.250" Cylindrical	0.150	3	0.630	2.5
46Y100ISR6RM140 IN2005	1.000	M06	.250" Cylindrical	0.183	3	0.550	2.5
46Y100ISR6RM200 IN2005	1.000	M06	.250" Cylindrical	0.183	3	0.790	2.5
46Y125ISR6RM180 IN2005	1.250	M08	.250" Cylindrical	0.234	3	0.710	2.5
46Y125ISR6RM240 IN2005	1.250	M08	.250" Cylindrical	0.234	3	0.940	2.5
46Y150ISR7RM230 IN2005	1.500	M10	.312" Cylindrical	0.307	3	0.910	2.5
46Y175ISR8RM260 IN2005	1.750	M12	.375" Cylindrical	0.354	3	1.020	3
47Y200ISS4RM350 IN2005	2.000	M16	.500" Cylindrical	0.465	4	1.380	3.5
47Y250ISS6RM430 IN2005	2.500	M20	.625" Cylindrical	0.591	5	1.690	4

Operating guidelines on [page 704](#).

SOLID CARBIDE THREAD MILLS - SMALL DIAMETER, SHORT, LEFT-HAND, UN PROFILE, 2XD AND 3XD

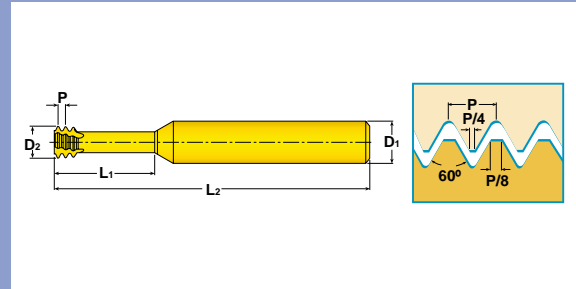

Cutter Number	IN2006	P Pitch (TPI)		Shank Style/Size	D2 Thread	No. of Flutes	L1 Extension Length	L2 Overall Length	
		UNC	UNF						
46Y-72UNR6LM040	IN2006	72	-	1	.250" Cylindrical	0.057	3	0.150	2.5
46Y-64UNR6LM040	IN2006	64	1	2	.250" Cylindrical	0.055	3	0.150	2.5
46Y-56UNR6LM040	IN2006	56	2	3	.250" Cylindrical	0.065	3	0.170	2.5
46Y-48UNR6LM050	IN2006	48	3	4	.250" Cylindrical	0.075	3	0.200	2.5
46Y-40UNR6LM060	IN2006	40	4	-	.250" Cylindrical	0.083	3	0.250	2.5
46Y-40UNR6LM070	IN2006	40	5	6	.250" Cylindrical	0.096	3	0.280	2.5
46Y-40UNR6LM100	IN2006	40	5	6	.250" Cylindrical	0.096	3	0.380	2.5
46Y-36UNR6LM090	IN2006	36	-	8	.250" Cylindrical	0.130	3	0.350	2.5
46Y-32UNR6LM070	IN2006	32	6	-	.250" Cylindrical	0.100	3	0.280	2.5
46Y-32UNR6LM090	IN2006	32	8	-	.250" Cylindrical	0.126	3	0.370	2.5
46Y-32UNR6LM100	IN2006	32	-	10	.250" Cylindrical	0.146	3	0.410	2.5
46Y-32UNR6LM120	IN2006	32	8	-	.312" Cylindrical	0.126	3	0.490	2.5
46Y-32UNR6LM150	IN2006	32	-	10	.250" Cylindrical	0.146	3	0.590	2.5
46Y-28UNR6LM110	IN2006	28	-	12	.250" Cylindrical	0.165	3	0.430	2.5
46Y-28UNR6LM140	IN2006	28	-	1/4	.250" Cylindrical	0.197	3	0.570	2.5
46Y-28UNR6LM190	IN2006	28	-	1/4	.250" Cylindrical	0.197	3	0.750	2.5
46Y-24UNR6LM110	IN2006	24	10, 12	-	.250" Cylindrical	0.138	3	0.420	2.5
46Y-24UNR7LM170	IN2006	24	-	5/16	.250" Cylindrical	0.260	3	0.670	2.5
46Y-24UNR7LM240	IN2006	24	-	5/16	.312" Cylindrical	0.260	3	0.940	2.5
46Y-20UNR6LM140	IN2006	20	1/4	-	.250" Cylindrical	0.187	3	0.550	2.5
46Y-20UNR6LM190	IN2006	20	1/4	-	.312" Cylindrical	0.187	3	0.750	2.5
46Y-18UNR6LM170	IN2006	18	5/16	-	.250" Cylindrical	0.236	3	0.670	2.5
46Y-18UNR6LM230	IN2006	18	5/16	-	.375" Cylindrical	0.236	3	0.910	2.5
46Y-16UNR7LM220	IN2006	16	3/8	-	.250" Cylindrical	0.264	3	0.870	2.5
46Y-14UNR7LM250	IN2006	14	7/16	-	.250" Cylindrical	0.303	3	0.980	2.5
46Y-13UNR8LM270	IN2006	13	1/2	-	.250" Cylindrical	0.362	3	1.080	3

Operating guidelines on [page 704](#).

RAPID THREAD SERIES 46Y_, 47Y_, 48Y_IS_LM

SOLID CARBIDE THREAD MILLS - SMALL DIAMETER, SHORT, LEFT-HAND, ISO PROFILE, 2XD AND 3XD

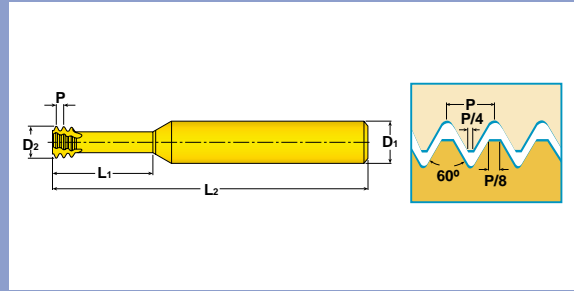

Cutter Number	P Pitch (mm)	Thread Size	Shank Style/Size	D2 Thread	No. of Flutes	L1 Extension Length	L2 Overall Length	
46Y040ISR6LM050	IN2006	0.400	M02	.250" Cylindrical	0.061	3	0.180	2.5
46Y045ISR6LM050	IN2006	0.450	M02.2	.250" Cylindrical	0.065	3	0.200	2.5
46Y045ISR6LM060	IN2006	0.450	M02.5	.250" Cylindrical	0.077	3	0.220	2.5
46Y045ISR6LM080	IN2006	0.450	M02.5	.250" Cylindrical	0.077	3	0.300	2.5
46Y050ISR6LM070	IN2006	0.500	M03	.250" Cylindrical	0.093	3	0.260	2.5
46Y050ISR6LM090	IN2006	0.500	M03	.250" Cylindrical	0.093	3	0.370	2.5
46Y060ISR6LM080	IN2006	0.600	M03.5	.250" Cylindrical	0.108	3	0.300	2.5
46Y070ISR6LM090	IN2006	0.700	M04	.250" Cylindrical	0.122	3	0.350	2.5
46Y070ISR6LM120	IN2006	0.700	M04	.250" Cylindrical	0.122	3	0.490	2.5
46Y080ISR6LM120	IN2006	0.800	M05	.250" Cylindrical	0.150	3	0.490	2.5
46Y080ISR6LM160	IN2006	0.800	M05	.250" Cylindrical	0.150	3	0.630	2.5
46Y100ISR6LM140	IN2006	1.000	M06	.250" Cylindrical	0.183	3	0.550	2.5
46Y100ISR6LM200	IN2006	1.000	M06	.250" Cylindrical	0.183	3	0.790	2.5
46Y125ISR6LM180	IN2006	1.250	M08	.250" Cylindrical	0.234	3	0.710	2.5
46Y125ISR6LM240	IN2006	1.250	M08	.250" Cylindrical	0.234	3	0.940	2.5
46Y150ISR7LM230	IN2006	1.500	M10	.312" Cylindrical	0.307	3	0.910	2.5
46Y175ISR8LM260	IN2006	1.750	M12	.375" Cylindrical	0.354	3	1.020	3

Operating guidelines on [page 704](#).

SOLID CARBIDE THREAD MILLING TIP - INTERNAL THREAD MILLS FOR UN THREAD

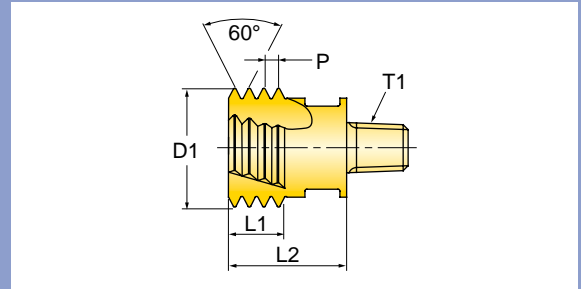

Cutter Number	IN2005	P Pitch (TPI)			Eff. Flutes	D1 Nominal Diameter	L1 Length of Cut	T1 Thread Size	L2 Extension Length
		UNC	UNF	UNEF					
47Y-24UNTQRA13	IN2005	24	-	9/16 & 5/8	4	0.394	0.252	T05	0.526
47Y-20UNTQRA13	IN2005	20	-	1/2	4	0.394	0.252	T05	0.526
47Y-18UNTQRA13	IN2005	18	-	9/16 & 5/8	4	0.394	0.220	T05	0.526
47Y-16UNT6RA17	IN2005	16	-	3/4	4	0.472	0.315	T06	0.671
47Y-14UNT8RA21	IN2005	14	-	7/8	5	0.630	0.500	T08	0.821
47Y-12UNT8RA21	IN2005	12	-	1 & 1-1/2	5	0.630	0.500	T08	0.821
47Y-10UNT8RA21	IN2005	10	3/4	-	4	0.602	0.500	T08	0.821
47Y-09UNT8RA21	IN2005	09	7/8	-	3	0.630	0.445	T08	0.821

Operating guidelines on [page 700](#).
For chip surfer shank selection, see [page 422](#).

HARDWARE



Wrench



Optional Torque Wrench

Cutter Number	IN2005	Wrench	Optional Torque Wrench
47Y-24UNTQRA13	IN2005	WS-0043	DT-60-06
47Y-20UNTQRA13	IN2005	WS-0043	DT-60-06
47Y-18UNTQRA13	IN2005	WS-0043	DT-60-06
47Y-16UNT6RA17	IN2005	WS-0029	DT-90-08
47Y-14UNT8RA21	IN2005	WS-0030	DT-130-10
47Y-12UNT8RA21	IN2005	WS-0030	DT-130-10
47Y-10UNT8RA21	IN2005	WS-0030	DT-130-10
47Y-09UNT8RA21	IN2005	WS-0030	DT-130-10

RAPID THREAD SERIES 47Y_IS_RA (CHIP-SURFER STYLE)

SOLID CARBIDE THREAD MILLING TIP - INTERNAL THREAD MILLS FOR ISO THREAD

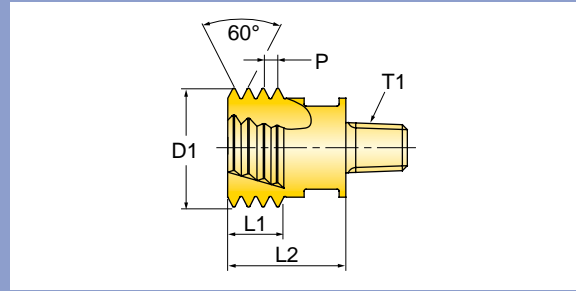

Cutter Number		P Pitch (mm)	M Course	M Fine	D1 Nom. Dia.	No. of Effective	L1	L2	T1 Thread Size
47Y075ISTQRA13	IN2005	0.750	-	0>=12	0.394	4	0.236	0.526	T05
47Y100ISTQRA13	IN2005	1.000	-	0>=12	0.394	4	0.236	0.526	T05
47Y150ISTQRA13	IN2005	1.500	-	0>=14	0.394	4	0.236	0.526	T05
47Y150IST6RA17	IN2005	1.500	-	0>=16	0.472	4	0.295	0.671	T06
48Y150IST8RA21	IN2005	1.500	-	0>=20	0.630	6	0.472	0.821	T08
47Y200IST6RA17	IN2005	2.000	M16	0>=17	0.472	4	0.315	0.671	T06
47Y200IST8RA21	IN2005	2.000	-	0>=19	0.630	5	0.472	0.821	T08
47Y250IST8RA20	IN2005	2.500	M20	0>=22	0.606	5	0.492	0.821	T08
47Y300IST8RA21	IN2005	3.000	M24	0>=25	0.630	3	0.472	0.821	T08

Operating guidelines on [page 700](#).
For chip surfer shank selection, see [page 422](#).

HARDWARE

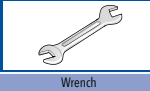

Wrench



Optional Torque Wrench

47Y075ISTQRA13	IN2005	WS-0043	DT-60-06
47Y100ISTQRA13	IN2005	WS-0043	DT-60-06
47Y150ISTQRA13	IN2005	WS-0043	DT-60-06
47Y150IST6RA17	IN2005	WS-0029	DT-90-08
48Y150IST8RA21	IN2005	WS-0030	DT-130-10
47Y200IST6RA17	IN2005	WS-0029	DT-90-08
47Y200IST8RA21	IN2005	WS-0030	DT-130-10
47Y250IST8RA20	IN2005	WS-0030	DT-130-10
47Y300IST8RA21	IN2005	WS-0030	DT-130-10

INDEXABLE THREAD MILLS

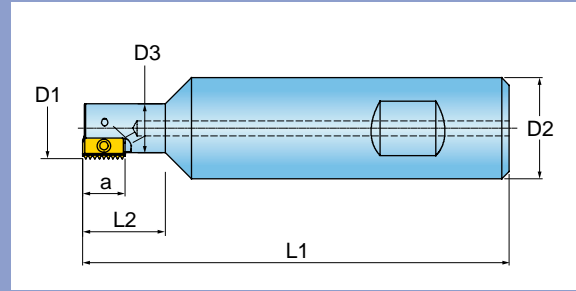

Cutter Number	a	D1	D2 Shank	D3	L1 Overall Length	L2 Extension Length	No. of Flutes
12Y1H-0301384R01	0.472	0.370	0.750	0.300	3.350	0.550	1
12Y1H-0301384R02	0.472	0.390	0.750	0.300	3.350	0.630	1

Operating guidelines on [page 700](#).

A ISO-threading (internal) **B UN-threading (internal)** **C NPT-threading**

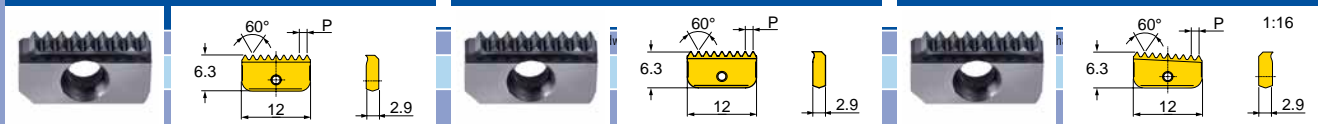

D NPTF-threading **E BSPT-threading** **F W-threading**

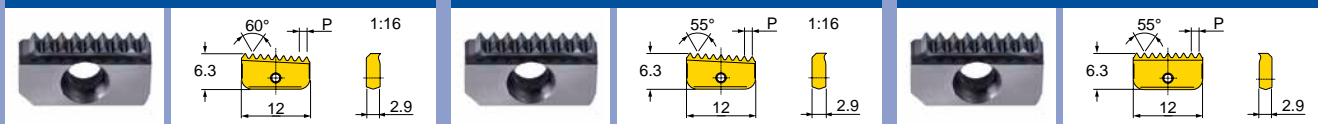

Designation	Pitch	Grade	IN1030	IN2030
ISO-threading (internal)				
LYEU12050IS	0.5	A		
LYEU12075IS	0.75	A		
LYEU12100IS	1	A		
LYEU12125IS	1.25	A		
LYEU12150IS	1.5	A		
UN-threading (internal)				
LYEU12320UN	32	B		
LYEU12280UN	28	B		
LYEU12240UN	24	B		
LYEU12200UN	20	B		

Designation	Pitch	Grade	IN1030	IN2030
NPT-threading				
LYEU12180UN	18	B		
LYEU12160UN	16	B		
NPTF-threading				
LYEU12180NT	18	C		
NPTF-threading				
LYEU12180NF	18	D		
BSPT-threading				
LYEU12190BT	19	E		
W-threading				
LYEU12190BW	19	F		

● = P ● = M ● = K ● = N ● = S ● = H

HARDWARE



Driver Screw

DS-T08W **IS12**



RAPID THREAD SERIES 12Y1J (14MM)

INDEXABLE THREAD MILLS

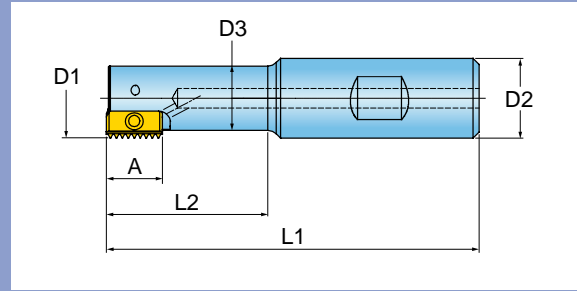

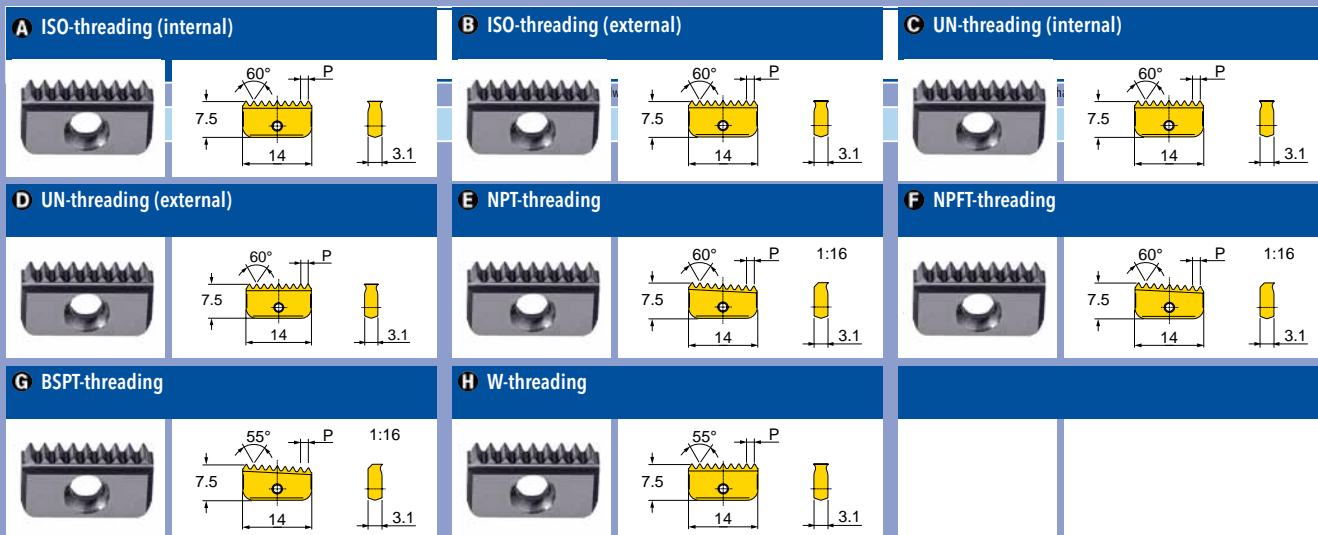

Cutter Number	a	D1	D2 Shank	D3	L1 Overall Length	L2 Extension Length	No. of Flutes
12Y1J-0501984R01	0.551	0.500	0.750	0.370	2.950	0.790	1
12Y1J-0500984R01	0.551	0.540	0.750	0.380	2.980	0.780	1
12Y1J-0501284R01	0.551	0.570	0.750	0.410	3.200	1.000	1
12Y1J-0601384R01	0.551	0.670	0.750	0.530	3.350	1.180	1
12Y1J-0701684R01	0.551	0.790	0.750	0.630	3.660	1.570	2

Operating guidelines on [page 700](#).

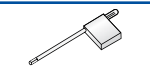

Designation	Pitch	Grade	IN1030	IN2030	Designation	Pitch	Grade	IN1030	IN2030
ISO-threading (internal)					UN-threading (external)				
LYEU14050IS	0.5	A	●	●	LYEU14100UN	10	C	●	●
LYEU14075IS	0.75	A	●	●	NPT-threading				
LYEU14100IS	1	A	●	●	LYEU14180NT	18	E	●	●
LYEU14125IS	1.25	A	●	●	LYEU14140NT	14	E	●	●
LYEU14150IS	1.5	A	●	●	NPFT-threading				
LYEU14175IS	1.75	A	●	●	LYEU14180NF	18	F	●	●
LYEU14200IS	2	A	●	●	LYEU14140NF	14	F	●	●
LYEU14250IS	2.5	A	●	●	BSPT-threading				
ISO-threading (external)					W-threading				
LYEU14075IS-X	0.75	B	●	●	LYEU14240BW	24	H	●	●
LYEU14100IS-X	1	B	●	●	LYEU14200BW	20	H	●	●
LYEU14125IS-X	1.25	B	●	●	LYEU14190BW	19	H	●	●
LYEU14150IS-X	1.5	B	●	●	LYEU14160BW	16	H	●	●
LYEU14175IS-X	1.75	B	●	●	LYEU14140BW	14	H	●	●
LYEU14200IS-X	2	B	●	●					
LYEU14250IS-X	2.5	B	●	●					
UN-threading (internal)									
LYEU14320UN	32	C	●	●					
LYEU14280UN	28	C	●	●					
LYEU14270UN	27	C	●	●					
LYEU14240UN	24	C	●	●					
LYEU14200UN	20	C	●	●					
LYEU14180UN	18	C	●	●					
LYEU14160UN	16	C	●	●					
LYEU14140UN	14	C	●	●					
LYEU14120UN	12	C	●	●					

● = P ● = M ● = K ● = N ● = S ● = H

HARDWARE		
	Driver	Screw
DS-T08W		IS14

INDEXABLE THREAD MILLS

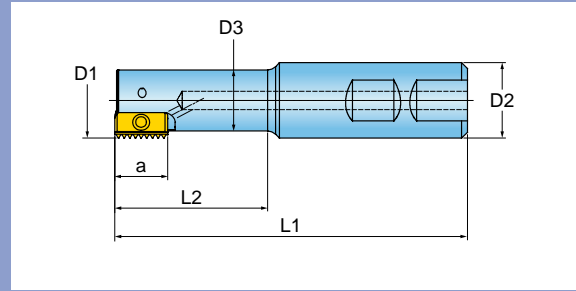

Cutter Number	a	D1	D2 Shank	D3	L1 Overall Length	L2 Extension Length	No. of Flutes
12Y1N-0701684R01	0.827	0.790	0.750	0.610	3.700	1.570	1
12Y1N-0903084R01	0.827	0.940	0.750	0.610	5.000	1.570	1
12Y1N-1102080R01	0.827	1.180	1.000	0.950	4.250	1.970	2

Operating guidelines on [page 700](#).

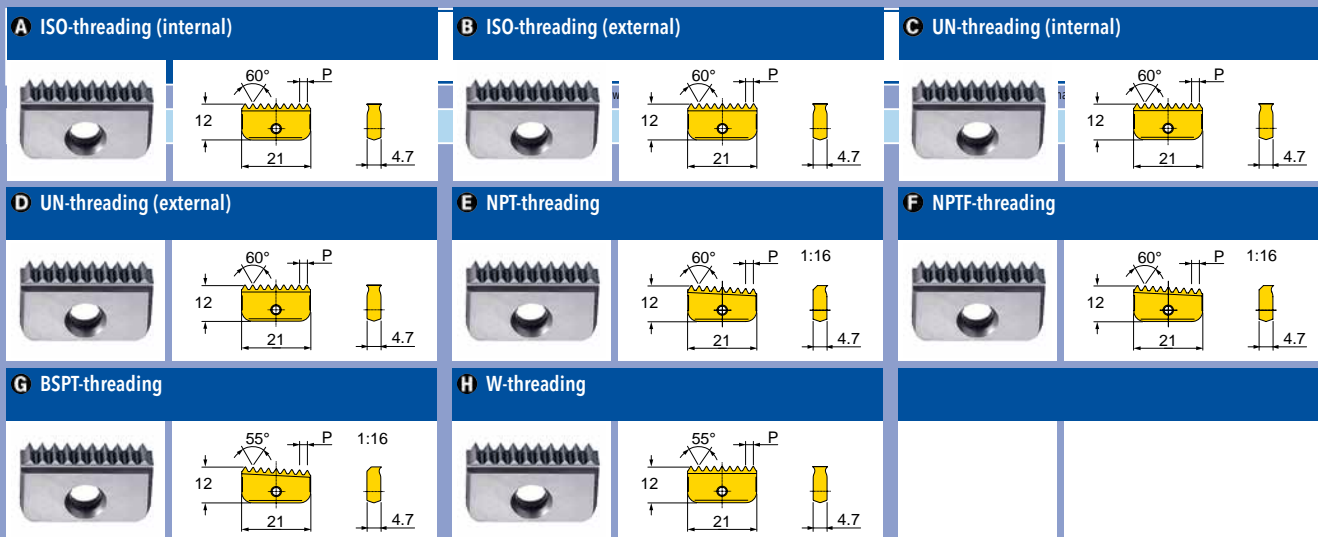

Designation	Pitch	Grade	IN1030	IN2030
ISO-threading (internal)				
LYEU21100IS	1	A	●	●
LYEU21150IS	1.5	A	●	●
LYEU21175IS	1.75	A	●	●
LYEU21200IS	2	A	●	●
LYEU21250IS	2.5	A	●	●
LYEU21300IS	3	A	●	●
LYEU21350IS	3.5	A	●	●
ISO-threading (external)				
LYEU21100IS-X	1	B	●	●
LYEU21150IS-X	1.5	B	●	●
LYEU21200IS-X	2	B	●	●
LYEU21250IS-X	2.5	B	●	●
LYEU21300IS-X	3	B	●	●
UN-threading (internal)				
LYEU21240UN	24	C	●	●
LYEU21200UN	20	C	●	●
LYEU21180UN	18	C	●	●
LYEU21160UN	16	C	●	●
LYEU21140UN	14	C	●	●
LYEU21120UN	12	C	●	●
LYEU21100UN	10	C	●	●
LYEU21080UN	8	C	●	●
LYEU21070UN	7	C	●	●
UN-threading (external)				

Designation	Pitch	Grade	IN1030	IN2030
UN-threading (internal)				
LYEU21240UN-X	24	D	●	●
LYEU21200UN-X	20	D	●	●
LYEU21180UN-X	18	D	●	●
LYEU21160UN-X	16	D	●	●
LYEU21140UN-X	14	D	●	●
LYEU21120UN-X	12	D	●	●
LYEU21100UN-X	10	D	●	●
NPT-threading				
LYEU21140NT	14	E	●	●
LYEU21115NT	11.5	E	●	●
NPTF-threading				
LYEU21140NF	14	F	●	●
LYEU21115NF	11.5	F	●	●
BSPT-threading				
LYEU21140BT	14	G	●	●
LYEU21110BT	11	G	●	●
W-threading				
LYEU21200BW	20	H	●	●
LYEU21190BW	19	H	●	●
LYEU21160BW	16	H	●	●
LYEU21140BW	14	H	●	●
LYEU21110BW	11	H	●	●

● = P ● = M ● = K ● = N ● = S ● = H

HARDWARE		
	Driver	Screw
DS-T15T		IS21

INDEXABLE THREAD MILLS

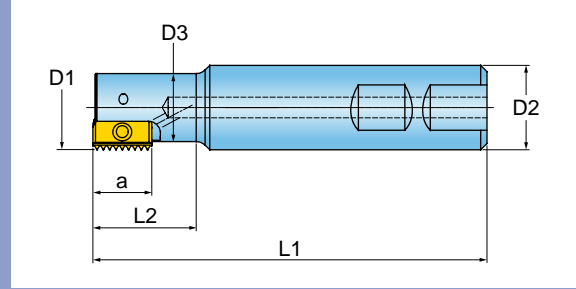

Cutter Number	a	D1	D2 Shank	D3	L1 Overall Length	L2 Extension Length	No. of Flutes
12Y1S-1102080R01	1.181	1.140	1.000	0.910	4.270	1.970	1
12Y1S-1203780R01	1.181	1.240	1.000	0.910	6.000	1.970	1
12Y1S-1503781R01	1.181	1.500	1.250	0.910	6.000	1.970	1
12Y1S-1502881R01	1.181	1.580	1.250	1.180	6.000	1.970	2

Operating guidelines on [page 700](#).

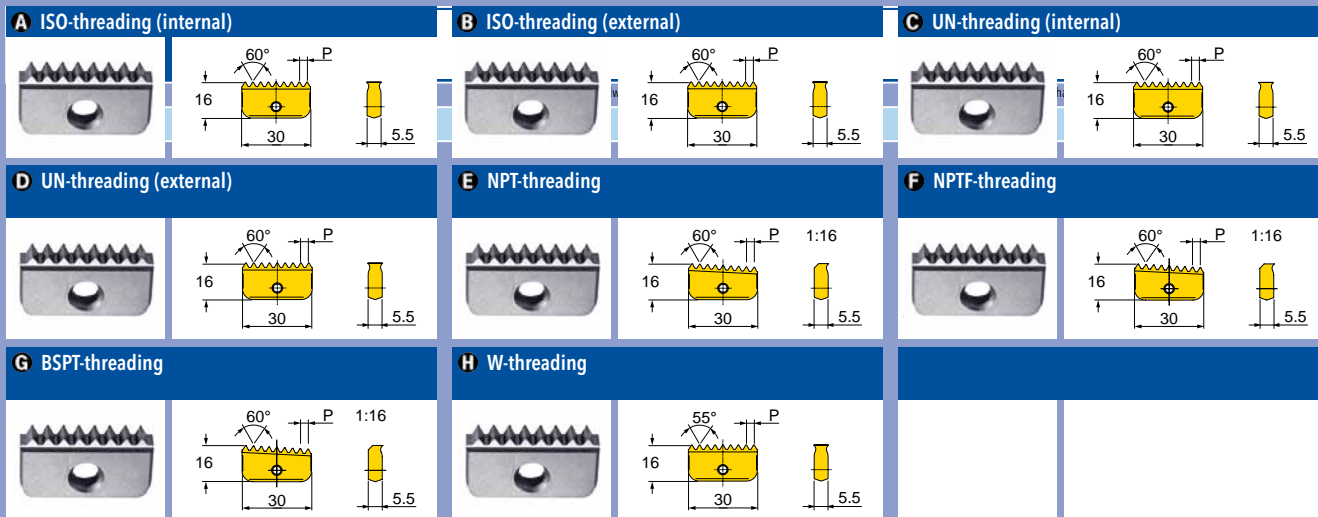

Designation	Pitch	Grade	IN1030	IN2030	Designation	Pitch	Grade	IN1030	IN2030
ISO-threading (internal)					UN-threading (external)				
LYOU30150IS	1.5	A	●	●	LYOU30200UN-X	20	D	●	●
LYOU30200IS	2	A	●	●	LYOU30180UN-X	18	D	●	●
LYOU30300IS	3	A	●	●	LYOU30160UN-X	16	D	●	●
LYOU30350IS	3.5	A	●	●	LYOU30140UN-X	14	D	●	●
LYOU30400IS	4	A	●	●	LYOU30120UN-X	12	D	●	●
LYOU30450IS	4.5	A	●	●	LYOU30100UN-X	10	D	●	●
LYOU30500IS	5	A	●	●	LYOU30080UN-X	8	D	●	●
ISO-threading (external)					NPT-threading				
LYOU30150IS-X	1.5	B	●	●	LYOU30115NT	11.5	E	●	●
LYOU30200IS-X	2	B	●	●	LYOU30080NT	8	E	●	●
LYOU30300IS-X	3	B	●	●	NPTF-threading				
LYOU30350IS-X	3.5	B	●	●	LYOU30115NF	11.5	F	●	●
LYOU30400IS-X	4	B	●	●	LYOU30080NF	8	F	●	●
UN-threading (internal)					BSPT-threading				
LYOU30200UN	20	C	●	●	LYOU30110BT	11	G	●	●
LYOU30180UN	18	C	●	●	W-threading				
LYOU30160UN	16	C	●	●	LYOU30160BW	16	H	●	●
LYOU30140UN	14	C	●	●	LYOU30140BW	14	H	●	●
LYOU30120UN	12	C	●	●	LYOU30110BW	11	H	●	●
LYOU30100UN	10	C	●	●	● = P ● = M ● = K ● = N ● = S ○ = H				
LYOU30080UN	8	C	●	●					
LYOU30060UN	6	C	●	●					

HARDWARE		
	Driver	Screw
DS-T25T		IS30

INDEXABLE THREAD MILLS

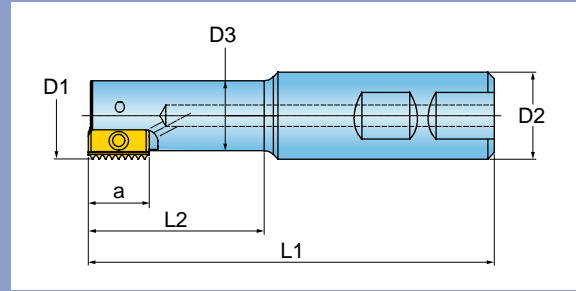

Cutter Number	a	D1	D2 Shank	D3	L1 Overall Length	L2 Extension Length	No. of Flutes
12Y1U-1703386R01	1.575	1.730	1.500	1.380	6.020	3.070	1
12Y1U-1903386R01	1.575	1.970	1.500	1.490	6.020	1.970	2

Operating guidelines on [page 700](#).

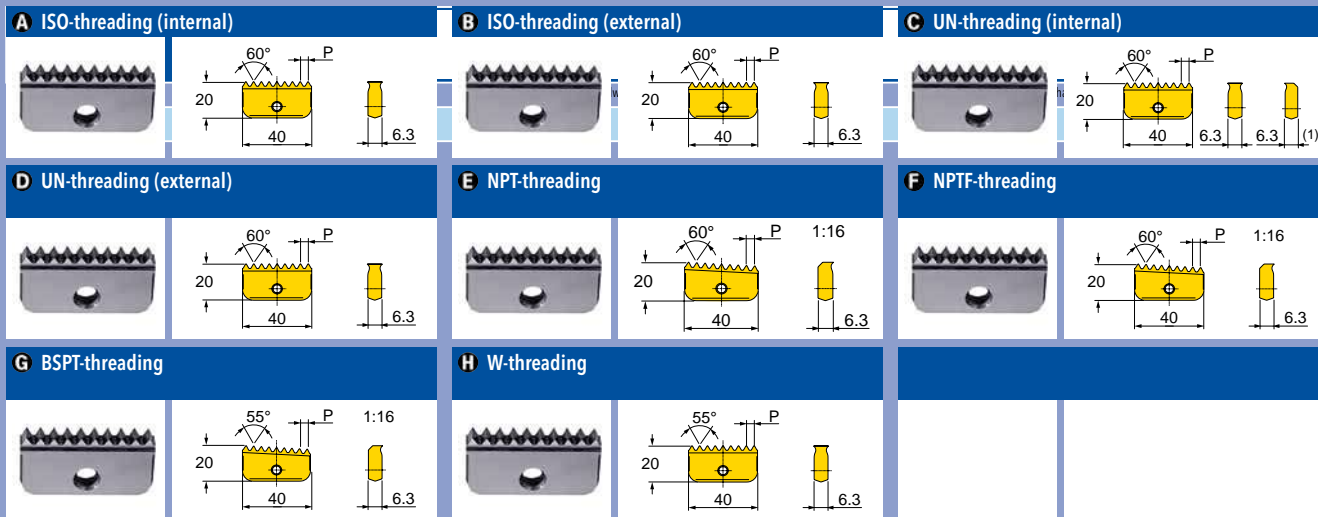

Designation	Pitch	Grade	IN1030	IN2030	Designation	Pitch	Grade	IN1030	IN2030
ISO-threading (internal)					UN-threading (external)				
LYEU40150IS	1.5	A	●	●	LYEU40080UN	8	C	●	●
LYEU40200IS	2	A	●	●	LYEU40060UN	6	C	●	●
LYEU40300IS	3	A	●	●	LYEU40045UN	4.5	C	●	●
LYEU40350IS	3.5	A	●	●	LYEU40040UN	4	C	●	●
LYEU40400IS	4	A	●	●	NPT-threading				
LYEU40450IS	4.5	A	●	●	LYEU40115NT	11.5	E	●	●
LYEU40500IS	5	A	●	●	LYEU40080NT	8	E	●	●
LYEU40550IS	5.5	A	●	●	NPTF-threading				
LYEU40600IS	6	A	●	●	LYEU40115NF	11.5	F	●	●
ISO-threading (external)					LYEU40080NF	8	F	●	●
LYEU40150IS-X	1.5	B	●	●	BSPT-threading				
LYEU40200IS-X	2	B	●	●	LYEU40110BT	11	G	●	●
LYEU40300IS-X	3	B	●	●	W-threading				
LYEU40400IS-X	4	B	●	●	LYEU40110BW	11	H	●	●
LYEU40500IS-X	5	B	●	●	LYEU40080BW	8	H	●	●
LYEU40600IS-X	6	B	●	●					
UN-threading (internal)									
LYEU40160UN	16	C	●	●					
LYEU40140UN	14	C	●	●					
LYEU40120UN	12	C	●	●					
LYEU40100UN	10	C	●	●					

● = P ● = M ● = K ● = N ● = S ● = H

HARDWARE		
	Driver	Screw
DS-T25T		IS40



RAPID THREAD SERIES 12Y5J (14MM)

INDEXABLE THREAD MILLS - CARBIDE SHANK

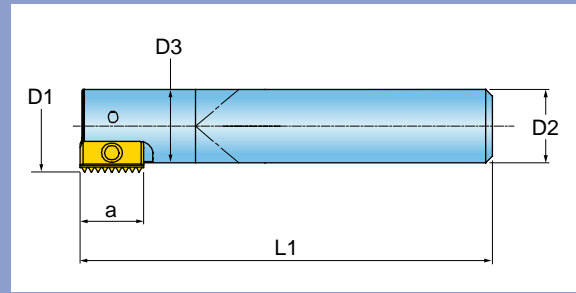

Cutter Number	a	D1	D2 Shank	D3	L1 Overall Length
12Y5J-05044R8R01	0.551	0.490	0.375	0.380	6.000
12Y5J-06052S4R01	0.551	0.620	0.500	0.500	7.000

Operating guidelines on [page 700](#).

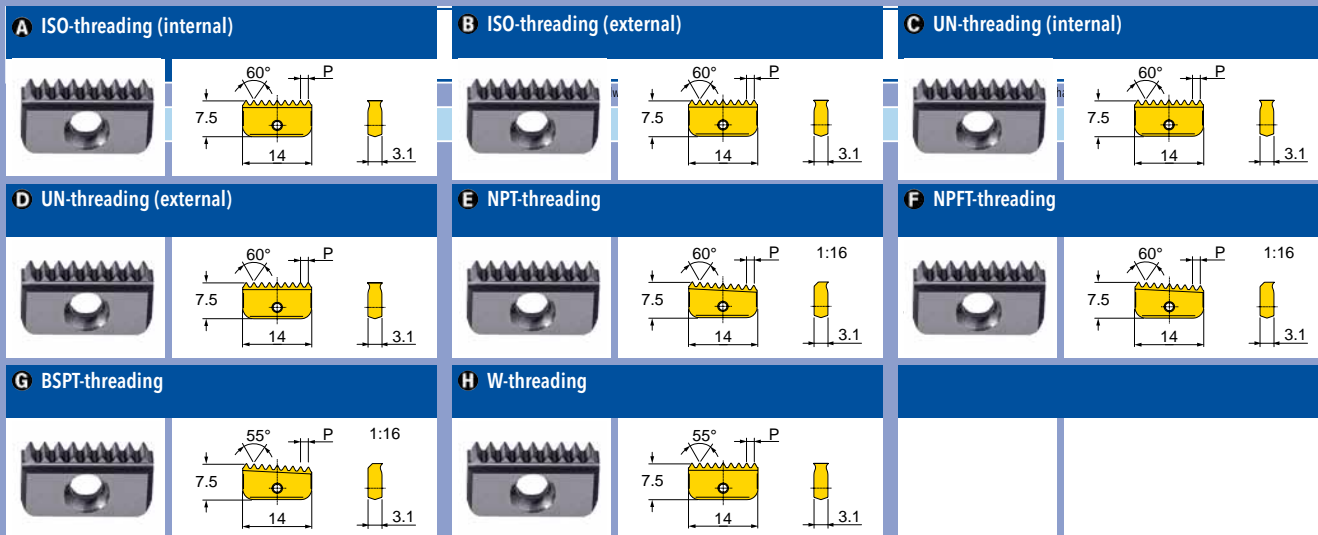

Designation	Pitch	Grade	IN1030	IN2030	Designation	Pitch	Grade	IN1030	IN2030
ISO-threading (internal)					UN-threading (external)				
LYEU14050IS	0.5	A	●	●	LYEU14100UN	10	C	●	●
LYEU14075IS	0.75	A	●	●	NPT-threading				
LYEU14100IS	1	A	●	●	LYEU14180NT	18	E	●	●
LYEU14125IS	1.25	A	●	●	LYEU14140NT	14	E	●	●
LYEU14150IS	1.5	A	●	●	NPFT-threading				
LYEU14175IS	1.75	A	●	●	LYEU14180NF	18	F	●	●
LYEU14200IS	2	A	●	●	LYEU14140NF	14	F	●	●
LYEU14250IS	2.5	A	●	●	BSPT-threading				
ISO-threading (external)					W-threading				
LYEU14075IS-X	0.75	B	●	●	LYEU14240BW	24	H	●	●
LYEU14100IS-X	1	B	●	●	LYEU14200BW	20	H	●	●
LYEU14125IS-X	1.25	B	●	●	LYEU14190BW	19	H	●	●
LYEU14150IS-X	1.5	B	●	●	LYEU14160BW	16	H	●	●
LYEU14175IS-X	1.75	B	●	●	LYEU14140BW	14	H	●	●
LYEU14200IS-X	2	B	●	●	UN-threading (internal)				
LYEU14250IS-X	2.5	B	●	●	LYEU14320UN	32	C	●	●
UN-threading (internal)					LYEU14280UN	28	C	●	●
LYEU14320UN	32	C	●	●	LYEU14270UN	27	C	●	●
LYEU14280UN	28	C	●	●	LYEU14240UN	24	C	●	●
LYEU14270UN	27	C	●	●	LYEU14200UN	20	C	●	●
LYEU14240UN	24	C	●	●	LYEU14180UN	18	C	●	●
LYEU14200UN	20	C	●	●	LYEU14160UN	16	C	●	●
LYEU14180UN	18	C	●	●	LYEU14140UN	14	C	●	●
LYEU14160UN	16	C	●	●	LYEU14120UN	12	C	●	●
LYEU14140UN	14	C	●	●					
LYEU14120UN	12	C	●	●					

● = P ● = M ● = K ● = N ● = S ○ = H

HARDWARE		
	Driver	Screw
DS-T08W		IS14



RAPID THREAD SERIES 12Y5N (21MM)

INDEXABLE THREAD MILLS - CARBIDE SHANK

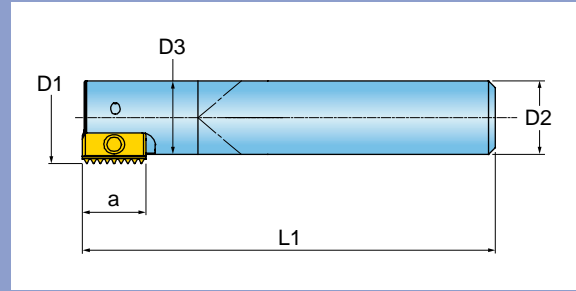

Cutter Number	a	D1	D2 Shank	D3	L1 Overall Length
12Y5N-08060S6R01	0.827	0.820	0.625	0.630	8.000

Operating guidelines on [page 700](#).

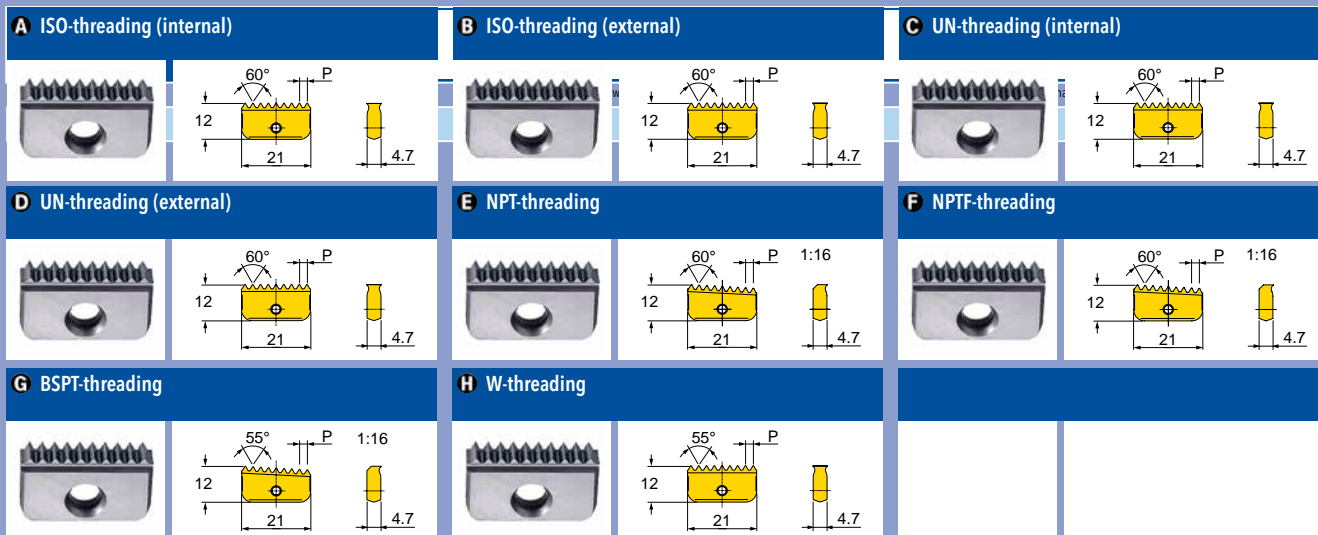

Designation	Pitch	Grade	IN1030	IN2030	Designation	Pitch	Grade	IN1030	IN2030
ISO-threading (internal)					UN-threading (internal)				
LYOU21100IS	1	A	●	●	LYOU21240UN-X	24	D	●	●
LYOU21150IS	1.5	A	●	●	LYOU21200UN-X	20	D	●	●
LYOU21175IS	1.75	A	●	●	LYOU21180UN-X	18	D	●	●
LYOU21200IS	2	A	●	●	LYOU21160UN-X	16	D	●	●
LYOU21250IS	2.5	A	●	●	LYOU21140UN-X	14	D	●	●
LYOU21300IS	3	A	●	●	LYOU21120UN-X	12	D	●	●
LYOU21350IS	3.5	A	●	●	LYOU21100UN-X	10	D	●	●
ISO-threading (external)					NPT-threading				
LYOU21100IS-X	1	B	●	●	LYOU21140NT	14	E	●	●
LYOU21150IS-X	1.5	B	●	●	LYOU21115NT	11.5	E	●	●
LYOU21200IS-X	2	B	●	●	NPTF-threading				
LYOU21250IS-X	2.5	B	●	●	LYOU21140NF	14	F	●	●
LYOU21300IS-X	3	B	●	●	LYOU21115NF	11.5	F	●	●
UN-threading (external)					BSPT-threading				
LYOU21240UN	24	C	●	●	LYOU21140BT	14	G	●	●
LYOU21200UN	20	C	●	●	LYOU21110BT	11	G	●	●
LYOU21180UN	18	C	●	●	W-threading				
LYOU21160UN	16	C	●	●	LYOU21200BW	20	H	●	●
LYOU21140UN	14	C	●	●	LYOU21190BW	19	H	●	●
LYOU21120UN	12	C	●	●	LYOU21160BW	16	H	●	●
LYOU21100UN	10	C	●	●	LYOU21140BW	14	H	●	●
LYOU21080UN	8	C	●	●	LYOU21110BW	11	H	●	●
LYOU21070UN	7	C	●	●	○ = P ● = M ● = K ● = N ● = S ○ = H				

HARDWARE		
	Driver	Screw
DS-T15T		IS21



RAPID THREAD SERIES 12Y1N_D (21MM)



INDEXABLE THREAD MILLS - SHELL MILL

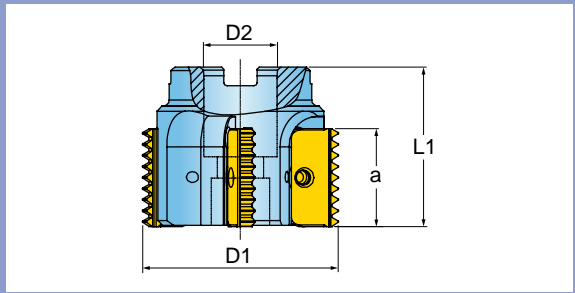

Cutter Number	a	D1	D2 Pilot	L1 Height	No. of Flutes
12Y1N-24019D1R01	0.827	2.480	0.750	1.970	5

Operating guidelines on [page 700](#).

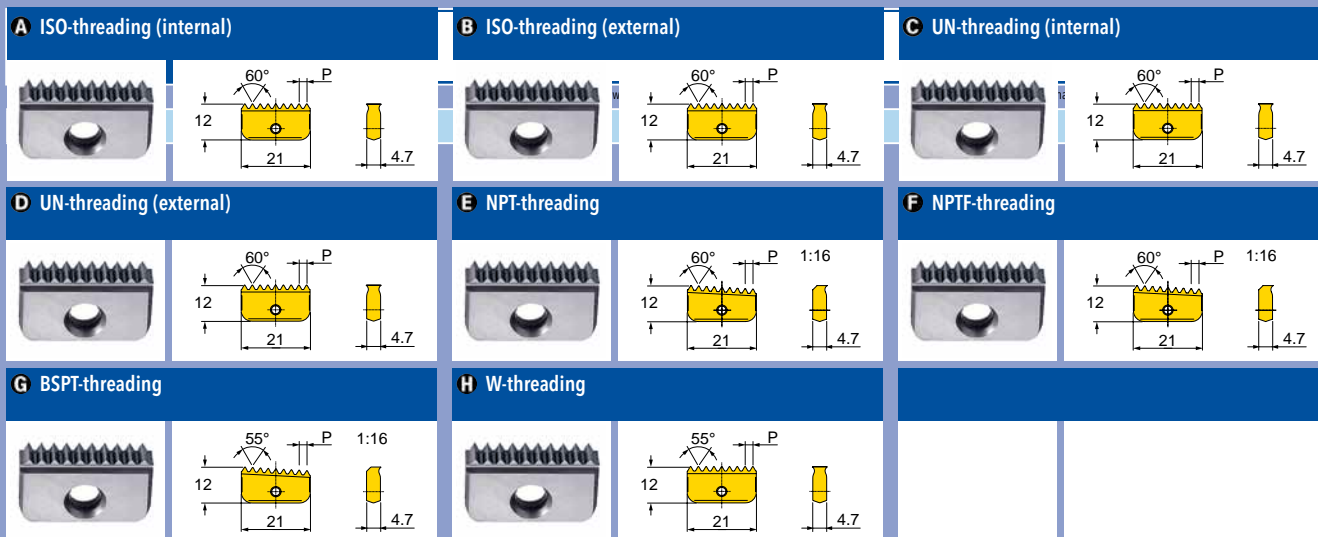

Designation	Pitch	Grade	IN1030	IN2030
ISO-threading (internal)				
LYEU21100IS	1	A	●	●
LYEU21150IS	1.5	A	●	●
LYEU21175IS	1.75	A	●	●
LYEU21200IS	2	A	●	●
LYEU21250IS	2.5	A	●	●
LYEU21300IS	3	A	●	●
LYEU21350IS	3.5	A	●	●
ISO-threading (external)				
LYEU21100IS-X	1	B	●	●
LYEU21150IS-X	1.5	B	●	●
LYEU21200IS-X	2	B	●	●
LYEU21250IS-X	2.5	B	●	●
LYEU21300IS-X	3	B	●	●
UN-threading (internal)				
LYEU21240UN	24	C	●	●
LYEU21200UN	20	C	●	●
LYEU21180UN	18	C	●	●
LYEU21160UN	16	C	●	●
LYEU21140UN	14	C	●	●
LYEU21120UN	12	C	●	●
LYEU21100UN	10	C	●	●
LYEU21080UN	8	C	●	●
LYEU21070UN	7	C	●	●
UN-threading (external)				

Designation	Pitch	Grade	IN1030	IN2030
UN-threading (internal)				
LYEU21240UN-X	24	D	●	●
LYEU21200UN-X	20	D	●	●
LYEU21180UN-X	18	D	●	●
LYEU21160UN-X	16	D	●	●
LYEU21140UN-X	14	D	●	●
LYEU21120UN-X	12	D	●	●
LYEU21100UN-X	10	D	●	●
NPT-threading				
LYEU21140NT	14	E	●	●
LYEU21115NT	11.5	E	●	●
NPTF-threading				
LYEU21140NF	14	F	●	●
LYEU21115NF	11.5	F	●	●
BSPT-threading				
LYEU21140BT	14	G	●	●
LYEU21110BT	11	G	●	●
W-threading				
LYEU21200BW	20	H	●	●
LYEU21190BW	19	H	●	●
LYEU21160BW	16	H	●	●
LYEU21140BW	14	H	●	●
LYEU21110BW	11	H	●	●

● = P ● = M ● = K ● = N ● = S ● = H

HARDWARE		
	Driver	Screw
DS-T15T		IS21

INDEXABLE THREAD MILLS - SHELL MILL

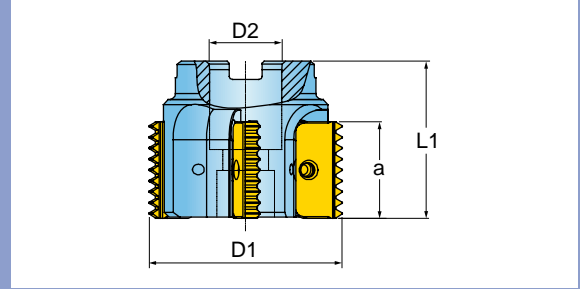

Cutter Number	a	D1	D2 Pilot	L1 Height	No. of Flutes
12Y1S-24019D1R01	1.181	2.480	0.750	1.970	4
12Y1S-31021D3R01	1.181	3.150	1.000	2.160	4
12Y1S-39025D4R01	1.181	3.940	1.250	2.560	4

Operating guidelines on [page 700](#).

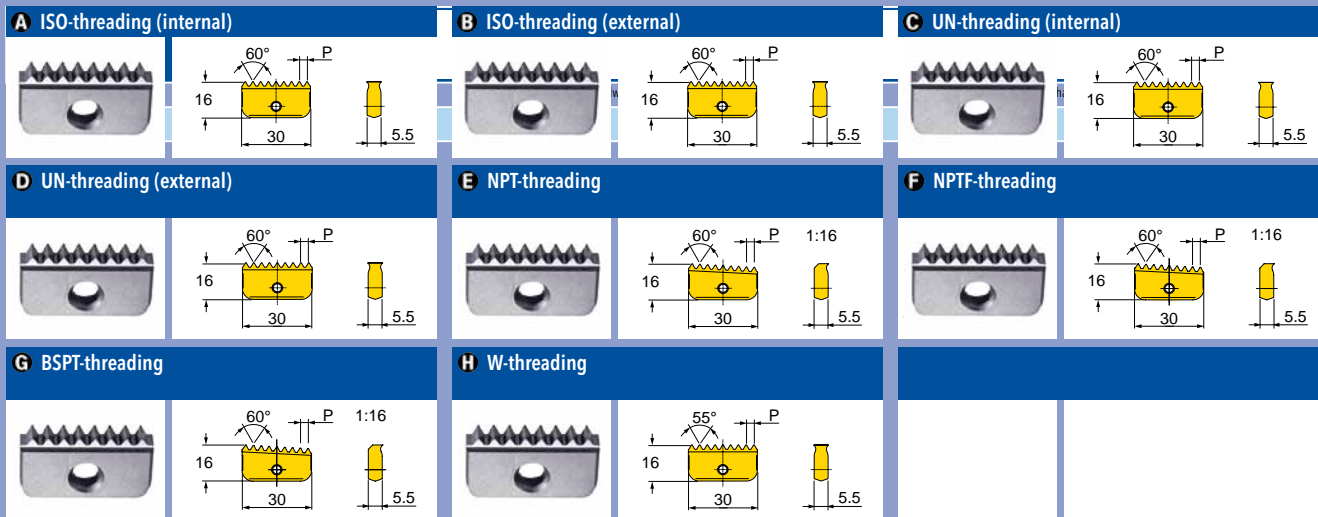

Designation	Pitch	Grade	IN1030	IN2030
-------------	-------	-------	--------	--------

ISO-threading (internal)				
LYOU30150IS	1.5	A	●	●
LYOU30200IS	2	A	●	●
LYOU30300IS	3	A	●	●
LYOU30350IS	3.5	A	●	●
LYOU30400IS	4	A	●	●
LYOU30450IS	4.5	A	●	●
LYOU30500IS	5	A	●	●
ISO-threading (external)				
LYOU30150IS-X	1.5	B	●	●
LYOU30200IS-X	2	B	●	●
LYOU30300IS-X	3	B	●	●
LYOU30350IS-X	3.5	B	●	●
LYOU30400IS-X	4	B	●	●
UN-threading (internal)				
LYOU30200UN	20	C	●	●
LYOU30180UN	18	C	●	●
LYOU30160UN	16	C	●	●
LYOU30140UN	14	C	●	●
LYOU30120UN	12	C	●	●
LYOU30100UN	10	C	●	●
LYOU30080UN	8	C	●	●
LYOU30060UN	6	C	●	●

Designation	Pitch	Grade	IN1030	IN2030
-------------	-------	-------	--------	--------

UN-threading (external)				
LYOU30200UN-X	20	D	●	●
LYOU30180UN-X	18	D	●	●
LYOU30160UN-X	16	D	●	●
LYOU30140UN-X	14	D	●	●
LYOU30120UN-X	12	D	●	●
LYOU30100UN-X	10	D	●	●
LYOU30080UN-X	8	D	●	●
LYOU30060UN-X	6	D	●	●
NPT-threading				
LYOU30115NT	11.5	E	●	●
LYOU30080NT	8	E	●	●
NPTF-threading				
LYOU30115NF	11.5	F	●	●
LYOU30080NF	8	F	●	●
BSPT-threading				
LYOU30110BT	11	G	●	●
W-threading				
LYOU30160BW	16	H	●	●
LYOU30140BW	14	H	●	●
LYOU30110BW	11	H	●	●

● = P ● = M ● = K ● = N ● = S ○ = H

HARDWARE		
	Driver	Screw
	DS-T25T	IS30

INDEXABLE THREAD MILLS - SHELL MILL

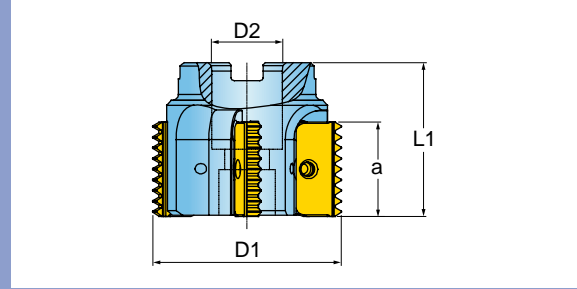

Cutter Number	a	D1	D2 Pilot	L1 Height	No. of Flutes
12Y1U-31023D3R01	1.575	3.150	1.000	2.360	4
12Y1U-39027D4R01	1.575	3.940	1.250	2.760	4

Operating guidelines on [page 700](#).

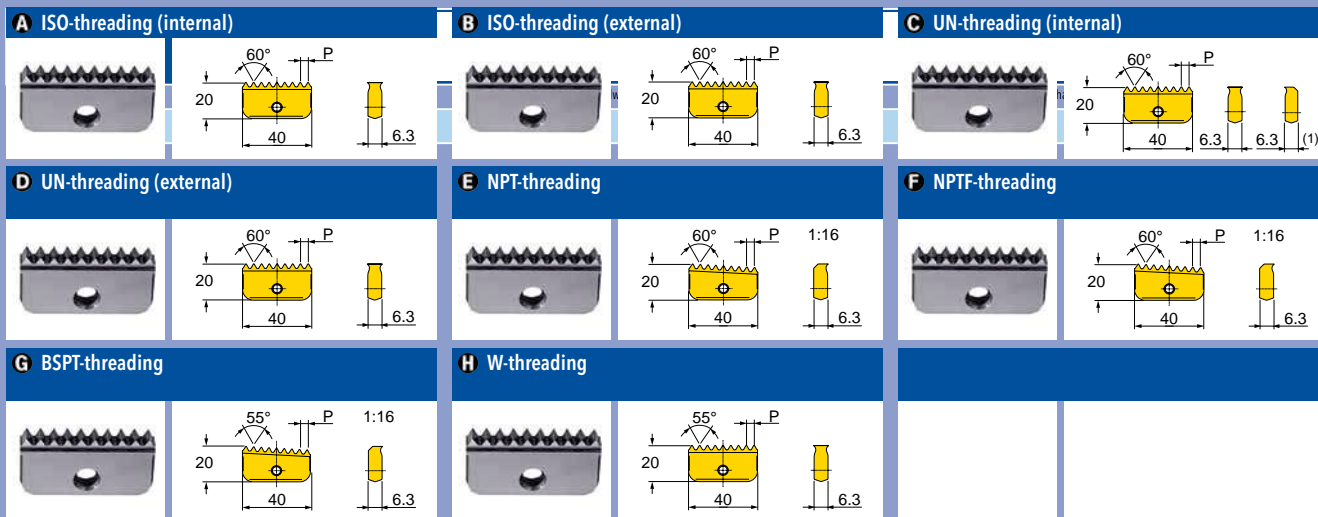

Designation	Pitch	Grade	IN1030	IN2030	Designation	Pitch	Grade	IN1030	IN2030
ISO-threading (internal)					UN-threading (external)				
LYEU40150IS	1.5	A	●	●	LYEU40080UN	8	C	●	●
LYEU40200IS	2	A	●	●	LYEU40060UN	6	C	●	●
LYEU40300IS	3	A	●	●	LYEU40045UN	4.5	C	●	●
LYEU40350IS	3.5	A	●	●	LYEU40040UN	4	C	●	●
LYEU40400IS	4	A	●	●	NPT-threading				
LYEU40450IS	4.5	A	●	●	LYEU40115NT	11.5	E	●	●
LYEU40500IS	5	A	●	●	LYEU40080NT	8	E	●	●
LYEU40550IS	5.5	A	●	●	NPTF-threading				
LYEU40600IS	6	A	●	●	LYEU40115NF	11.5	F	●	●
ISO-threading (external)					LYEU40080NF	8	F	●	●
LYEU40150IS-X	1.5	B	●	●	BSPT-threading				
LYEU40200IS-X	2	B	●	●	LYEU40110BT	11	G	●	●
LYEU40300IS-X	3	B	●	●	W-threading				
LYEU40400IS-X	4	B	●	●	LYEU40110BW	11	H	●	●
LYEU40500IS-X	5	B	●	●	LYEU40080BW	8	H	●	●
LYEU40600IS-X	6	B	●	●	UN-threading (internal)				
UN-threading (internal)					LYEU40160UN	16	C	●	●
LYEU40160UN	16	C	●	●	LYEU40140UN	14	C	●	●
LYEU40140UN	14	C	●	●	LYEU40120UN	12	C	●	●
LYEU40120UN	12	C	●	●	LYEU40100UN	10	C	●	●
LYEU40100UN	10	C	●	●					

● = P ● = M ● = K ● = N ● = S ○ = H

HARDWARE		
	Driver	Screw
	DS-T25T	IS40

INDEXABLE THREAD MILLS - HELICAL END MILL



application 1

application 2

application 3

application 4

application 5

application 6

application 7

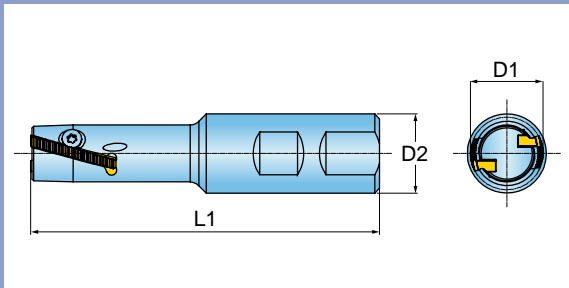

Cutter Number	a	D1	D2 Shank	L1 Overall Length	No. of Flutes
22Y3Q-0902280R01	0.900	1.060	1.000	4.500	2

Operating guidelines on [page 700](#).

A ISO-threading (internal) 	B UN/UNC/UNF/UNEF/UNS-threading (internal) 	C W/BSP/BSW/BSF/BSP-threading (internal & external)
D BSPT-threading (internal & external) 	E NPT-threading (internal & external) 	

Designation	Pitch	Grade	IN2030	Designation	Pitch	Grade	IN2030
ISO-threading (internal)				LYER23120UN 12 B			
LYER23100IS	1	A		LYER23080UN	8	B	
LYER23150IS	1.5	A		W/BSP/BSW/BSF/BSP-threading (internal & external)			
LYER23200IS	2	A		LYER23110BW	11	C	
LYER23300IS	3	A		BSPT-threading (internal & external)			
UN/UNC/UNF/UNEF/UNS-threading (internal)				LYER23110BT	11	D	
LYER23240UN	24	B		NPT-threading (internal & external)			
LYER23160UN	16	hardware desc 1	hardware desc 2	LYER23115NT	11.5	E	hardware desc 7

● = P ● = M ● = K ● = N ● = S ○ = H

HARDWARE		
	Driver	Screw
DS-T15T		IS23

RAPID THREAD SERIES 22Y3R (32MM)

INDEXABLE THREAD MILLS - HELICAL END MILL

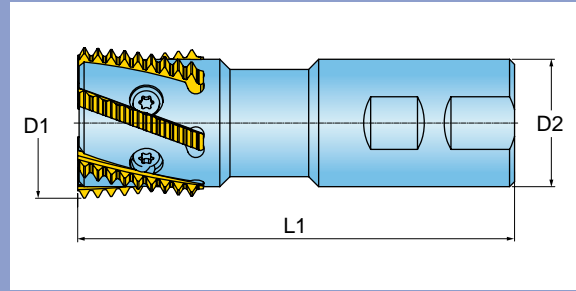

Cutter Number	a	D1	D2 Shank	L1 Overall Length	No. of Flutes
22Y3R-1302781R01	-	1.260	1.250	5.000	5

Operating guidelines on [page 700](#).

A ISO-threading (internal) 	B UN/UNC/UNF/UNEF/UNS-threading (internal) 	C W/BSP/BSW/BSF/BSP-threading (internal & external)
D BSPT-threading (internal & external) 	E NPT-threading (internal & external) 	

Designation	Pitch	Grade	IN2030	Designation	Pitch	Grade	IN2030
ISO-threading (internal)				W/BSP/BSW/BSF/BSP-threading (internal & external)			
LYER32150IS	1.5	A	●	LYER32080UN	8	B	●
LYER32200IS	2	A	●	LYER32060UN	6	B	●
LYER32300IS	3	A	●	NPT-threading (internal & external)			
LYER32400IS	4	A	●	LYER32110BT	11	D	●
UN/UNC/UNF/UNEF/UNS-threading (internal)				BSPT-threading (internal & external)			
LYER32160UN	16	B	●	LYER32110BT	11	D	●
LYER32120UN	12	B	●	LYER32115NT	11.5	E	●

● = P ● = M ● = K ● = N ● = S ○ = H

HARDWARE	Driver	Screw
	DS-T20T	IS32

INDEXABLE THREAD MILLS - HELICAL END MILL

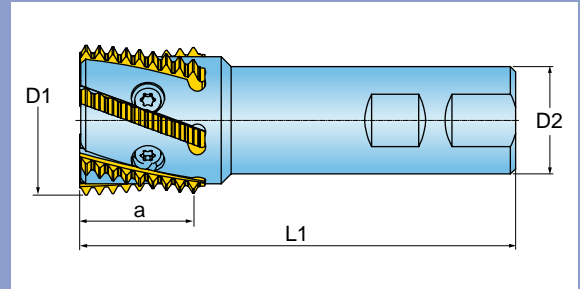

Cutter Number	a	D1	D2 Shank	L1 Overall Length	No. of Flutes
22Y3S-1802781R01	1.450	1.457	1.250	5.000	6

Operating guidelines on [page 700](#).

A ISO-threading (internal) 	B UN/UNC/UNF/UNEF/UNS-threading (internal) 	C W/BSP/BSW/BSF/BSP-threading (internal & external)
D BSPT-threading (internal & external) 	E NPT-threading (internal & external) 	

Designation	Pitch	Grade	IN2030	Designation	Pitch	Grade	IN2030
ISO-threading (internal)				W/BSP/BSW/BSF/BSP-threading (internal & external)			
LYER37150IS	1.5	A		LYER37080UN	8	B	
LYER37200IS	2	A		LYER37060UN	6	B	
LYER37300IS	3	A		BSPT-threading (internal & external)			
LYER37400IS	4	A		LYER37110BT	11	D	
UN/UNC/UNF/UNEF/UNS-threading (internal)				NPT-threading (internal & external)			
LYER37160UN	16	B		LYER37115NPT	11.5	E	
LYER37120UN	12	B					

● = P ● = M ● = K ● = N ● = S ○ = H

HARDWARE		
	Driver	Screw
DS-T25T		IS45

RAPID THREAD SERIES 22Y3T (38MM)

INDEXABLE THREAD MILLS - HELICAL SHELL MILL

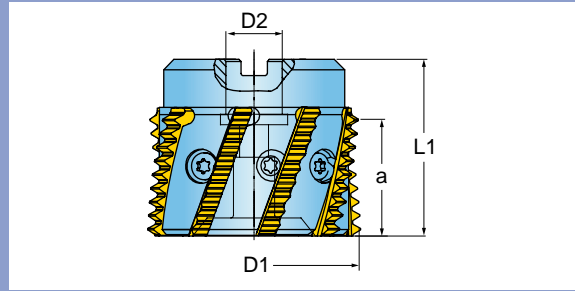

Cutter Number	a	D1	D2 Shank	L1 Height	No. of Flutes
22Y3T-25020D1R01	1.490	1.496	0.750	2.000	9

Operating guidelines on [page 700](#).

A ISO-threading (internal)

B UN/UNC/UNF/UNEF/UNS-threading (internal)

C W/BSP/BSW/BSF/BSP-threading (internal & external)

D BSPT-threading (internal & external)

E NPT-threading (internal & external)

Designation	Pitch	Grade	IN2030	Designation	Pitch	Grade	IN2030
ISO-threading (internal)				W/BSP/BSW/BSF/BSP-threading (internal & external)			
LYER38150IS	1.5	A		LYER38080UN	8	B	
LYER38200IS	2	A		LYER38060UN	6	B	
LYER38300IS	3	A		BSPT-threading (internal & external)			
LYER38400IS	4	A		LYER38110BT	11	C	
UN/UNC/UNF/UNEF/UNS-threading (internal)				NPT-threading (internal & external)			
LYER38160UN	16	B		LYER38110BW	11	D	
LYER38120UN	12	B	hardware desc 1	LYER38115NT	11	E	hardware desc 7

● = P ● = M ● = K ● = N ● = S ○ = H

HARDWARE	Driver	Screw
	DS-T25T	IS63

SINGLE FLUTE BRAZED GUN DRILLS

SINGLE FLUTE

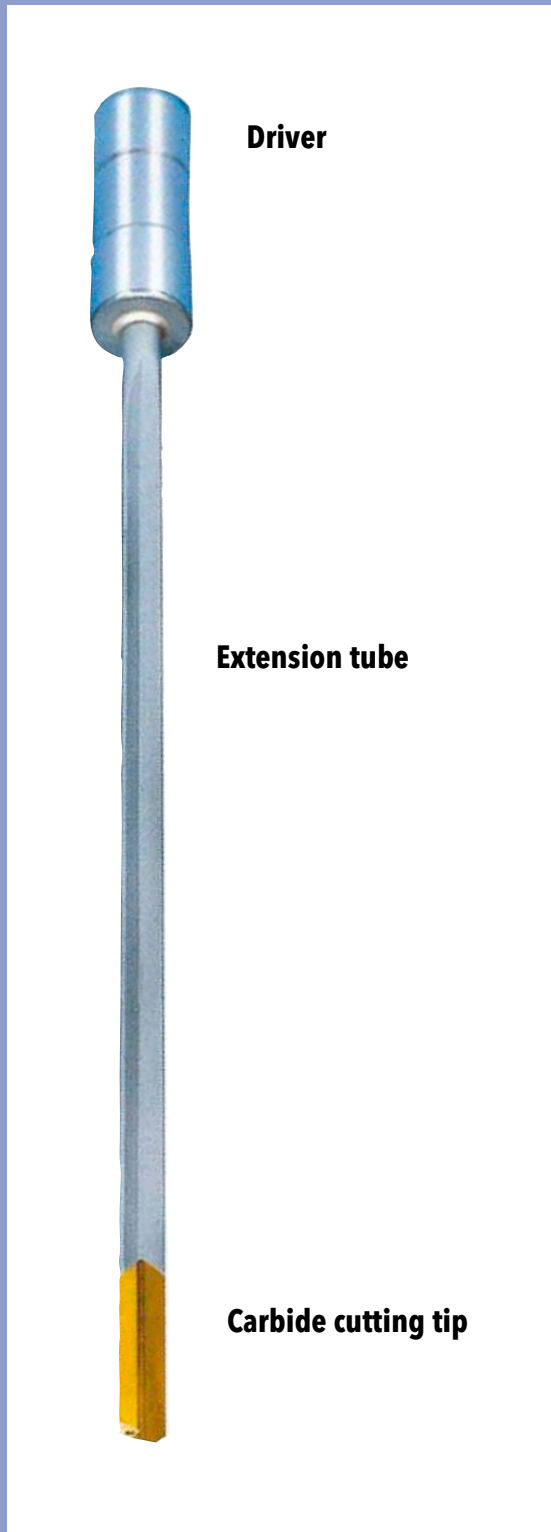

Diameter Range: Ø0.100" to Ø1.575"

Length Range: 5.9" to 118.0"

Advantages:

- Hole tolerances from IT7 to IT9 can be obtained
- Excellent straightness and concentricity
- Reduced position deviation
- Surface finish Ra 0.4 to 1.6 easily achieved
- Often eliminates secondary reaming operation

Carbide Cutting Tip

Available with 4 different standard cutting geometries, 8 different standard pad forms and 4 coating options for a multitude of applications.

Extension Tube

Designed with a V-shaped chip flute and coolant supply. The hardened steel extension tube provides optimum conditions for torsional strength, coolant flow and chip evacuation.

Driver

The steel driver provides the means to clamp the gun drill into the machine tool.

SOLID CARBIDE GUN DRILLS

SOLID CARBIDE

Diameter Range: \emptyset .035" to \emptyset .630"

Length Range: 40 x Drill Diameter up to 7.874" flute length

Made with an integral cutting tip and extension tube with either a steel or carbide driver. The solid carbide gun drill is designed for use in conventional machining centers and lathes. These drills provide superior rigidity with optimum coolant flow.

As a result, speeds and feeds up to 100 % faster may be obtained.



STANDARD BRAZED GUN DRILLS

STANDARDS

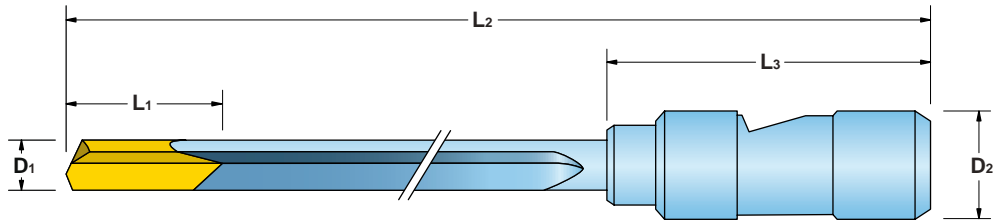

Part Number	D ₁ Diameter	L ₁ Tip Length	L ₂ Overall Length	Driver	D ₂ Driver Diameter	L ₃ Driver Length
STGD-03175-0254-76-IN05S	.1250	.787	10.00	76	.750	2.748
STGD-03175-0559-76-IN05S	.1250	.787	22.00	76	.750	2.748
STGD-03175-0914-76-IN05S	.1250	.787	36.00	76	.750	2.748
STGD-03962-0914-76-IN05S	.1560	.906	36.00	76	.750	2.748
STGD-04763-0254-76-IN05S	.1875	.904	10.00	76	.750	2.748
STGD-04763-0711-76-IN05S	.1875	.904	28.00	76	.750	2.748
STGD-04763-1219-76-IN05S	.1875	.904	48.00	76	.750	2.748
STGD-06350-0254-76-IN05S	.2500	1.181	10.00	76	.750	2.748
STGD-06350-0711-76-IN05S	.2500	1.181	28.00	76	.750	2.748
STGD-06350-1219-76-IN05S	.2500	1.181	48.00	76	.750	2.748
STGD-07938-0254-76-IN05S	.3125	1.378	16.00	76	.750	2.748
STGD-07938-0711-76-IN05S	.3125	1.378	28.00	76	.750	2.748
STGD-07938-1219-76-IN05S	.3125	1.378	48.00	76	.750	2.748
STGD-09525-0254-76-IN05S	.3750	1.378	16.00	76	.750	2.748
STGD-09525-0711-76-IN05S	.3750	1.378	28.00	76	.750	2.748
STGD-09525-1219-76-IN05S	.3750	1.378	48.00	76	.750	2.748
STGD-11113-0254-76-IN05S	.4375	1.575	16.00	76	.750	2.748
STGD-11113-0711-76-IN05S	.4375	1.575	28.00	76	.750	2.748
STGD-11113-1219-76-IN05S	.4375	1.575	48.00	76	.750	2.748
STGD-11113-1524-76-IN05S	.4375	1.575	60.00	76	.750	2.748
STGD-11506-0254-76-IN05S	.4530	1.575	16.00	76	.750	2.748
STGD-11506-0711-76-IN05S	.4530	1.575	28.00	76	.750	2.748
STGD-11506-1219-76-IN05S	.4530	1.575	48.00	76	.750	2.748
STGD-11506-1524-76-IN05S	.4530	1.575	60.00	76	.750	2.748
STGD-12700-0254-76-IN05S	.5000	1.575	16.00	76	.750	2.748
STGD-12700-0711-76-IN05S	.5000	1.575	28.00	76	.750	2.748
STGD-12700-1219-58-IN05S	.5000	1.575	48.00	58	1.000	2.748
STGD-12700-1524-58-IN05S	.5000	1.575	60.00	58	1.000	2.748
STGD-14288-0406-58-IN05S	.5625	1.575	16.00	58	1.000	2.748
STGD-14288-0711-58-IN05S	.5625	1.575	28.00	58	1.000	2.748
STGD-14288-1219-58-IN05S	.5625	1.575	48.00	58	1.000	2.748
STGD-14681-0254-58-IN05S	.5780	1.575	16.00	58	1.000	2.748
STGD-14681-0711-58-IN05S	.5780	1.575	28.00	58	1.000	2.748
STGD-14681-1219-58-IN05S	.5780	1.575	48.00	58	1.000	2.748
STGD-14681-1524-58-IN05S	.5780	1.575	60.00	58	1.000	2.748
STGD-15062-0254-58-IN05S	.5930	1.575	16.00	58	1.000	2.748
STGD-15062-0711-58-IN05S	.5930	1.575	28.00	58	1.000	2.748
STGD-15062-1219-58-IN05S	.5930	1.575	48.00	58	1.000	2.748
STGD-15062-1524-58-IN05S	.5930	1.575	60.00	58	1.000	2.748

STANDARD BRAZED GUN DRILLS

STANDARDS - CONT.

Part Number	D ₁ Diameter	L ₁ Tip Length	L ₂ Overall Length	Driver	D ₂ Driver Diameter	L ₃ Driver Length
STGD-15875-0406-58-IN05S	.6250	1.575	16.00	58	1.000	2.748
STGD-15875-0711-58-IN05S	.6250	1.575	28.00	58	1.000	2.748
STGD-15875-1219-58-IN05S	.6250	1.575	48.00	58	1.000	2.748
STGD-19837-0254-58-IN05S	.7810	1.772	16.00	58	1.000	2.748
STGD-19837-0711-58-IN05S	.7810	1.772	28.00	58	1.000	2.748
STGD-19837-1219-58-IN05S	.7810	1.772	48.00	58	1.000	2.748
STGD-19837-1524-58-IN05S	.7810	1.772	60.00	58	1.000	2.748
STGD-20638-0254-58-IN05S	.8125	1.772	16.00	58	1.000	2.748
STGD-20638-0711-58-IN05S	.8125	1.772	28.00	58	1.000	2.748
STGD-20638-1219-58-IN05S	.8125	1.772	48.00	58	1.000	2.748
STGD-20638-1524-58-IN05S	.8125	1.772	60.00	58	1.000	2.748
STGD-25400-0559-59-IN05S	1.000	2.165	22.00	59	1.250	2.748
STGD-25400-0914-59-IN05S	1.000	2.165	36.00	59	1.250	2.748
STGD-25400-1219-59-IN05S	1.000	2.165	48.00	59	1.250	2.748

Operating guidelines on [page 708](#).

STANDARD GUN DRILL SHARPENING ANGLES

SHARPENING ANGLES

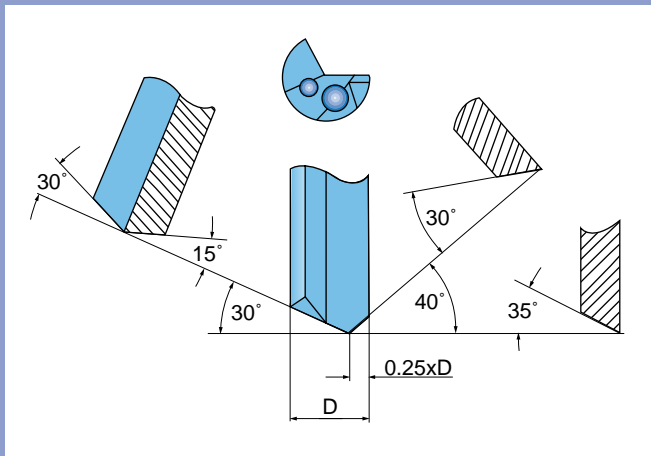

Standard sharpening for diameters less than .157"

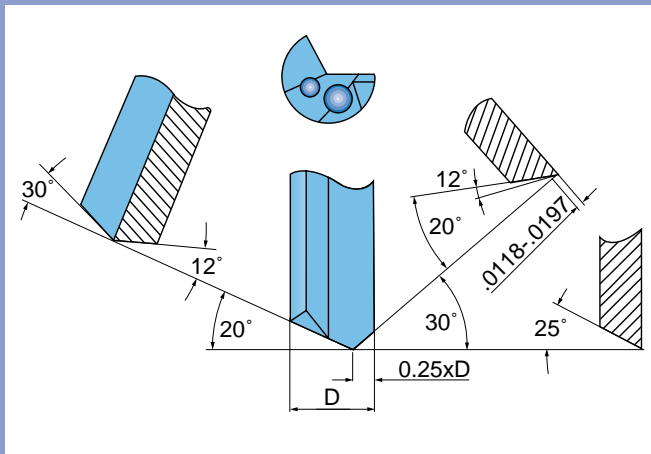

Standard sharpening for diameters greater than .157"

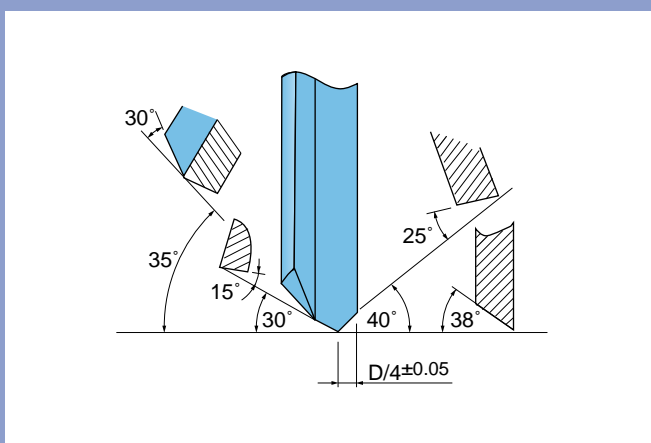

Optional sharpening for materials where it is difficult to break a chip.

Depending on the required tolerance, cutting performance and desired chip shape, the following standard sharpening angles are recommended.

Standard Gun Drill Carbide Length

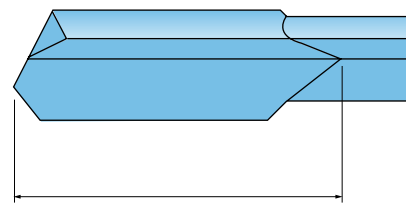

Diameter Range Head Length

.098" - .149"	.787"
.150" - .159"	.906"
.160" - .199"	.094"
.200" - .258"	1.181"
.259" - .435"	1.378"
.436" - .722"	1.575"
.723" - .841"	1.772"
.842" - .919"	1.970"
.920" - 1.037"	2.165"
1.038" - 1.260"	2.560"

Regrindable Length = Length-Dia.

STANDARD GUN DRILL PAD FORMS

PAD FORMS

Drilling capacity and hole finish depend on the geometrical shape of the drill head. Both pad form and sharpening must be adjusted to the workpiece material. The pad form is determined when the tool is manufactured. Regrinding may change the cutting geometry, but the pad form will remain the same.

All cross section profile parameters such as: P , La and α must be precisely adjusted to the workpiece material properties.

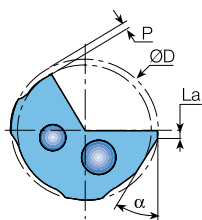

Universal G-Form

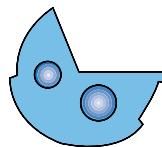

Applications:

For all material groups.
Works well in materials that tend to shrink.
Maintains precision bore tolerance and straightness.

Standard A-Form

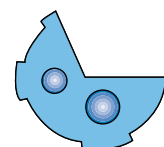

Applications:

For cast iron & aluminum alloys (coated).
Drilling through cross holes and angled entry and exits.
Large gap between pads ensures good lubrication.

Standard B-Form

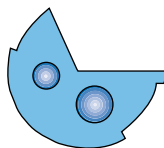

Applications:

For cast iron & aluminum alloys.
Maintains high precision hole tolerances.
Excellent surface finish.

Standard C-Form

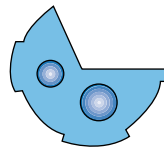

Applications:

With larger back taper for use in materials that tend to shrink. (Some alloys and stainless steels).
Drilling through cross holes and angled entry and exit.
Not recommended for precise straightness control.

Standard D-Form

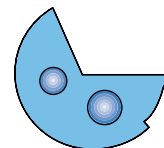

Applications:

For cast iron only (with coating).
Works very well in gray cast iron.

Standard E-Form

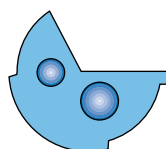

Applications:

General purpose for all materials.
Commonly used in crankshaft and other forged materials.
Precise straightness control.

Standard H-Form

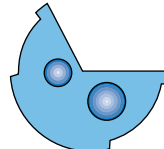

Applications:

For all non-ferrous materials.
For cast iron greater than 5 mm hole diameter.
Can be used in wood & plastic with a larger back taper.

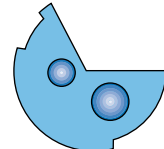

Standard I-Form



Applications:

For aluminum and brass when best surface finish is required.
Can be used in cross hole and interrupted cut applications.

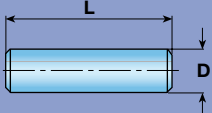
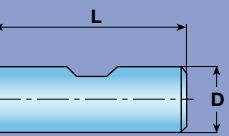
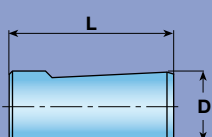
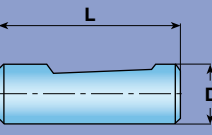
STANDARD GUN DRILL DRIVERS FOR MACHINING CENTERS, LATHES, ETC.

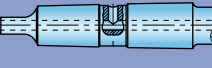
Driver Type	Drawing	D x L	Driver Code	Carbide Tipped Gun Drills	Solid Carbide Gun Drills
Cylindrical DIN1835A DIN6535HA		.157 x 1.102	01	●	●
		.197 x 1.102	02		●
		.236 x 1.417	03	●	●
		.315 x 1.417	04	●	●
		.394 x 1.575	05	●	●
		.472 x 1.772	06	●	●
		.551 x 1.772	07		●
		.630 x 1.890	08	●	●
		.709 x 1.890	09		
		.787 x 1.968	10	●	
		.984 x 2.205	11	●	
		1.260 x 2.362	12	●	
		1.575 x 2.756	13		
		1.969 x 3.150	14		
		2.480 x 3.543	15		
Weldon DIN1835B		.236 x 1.417	16	●	
		.315 x 1.417	17	●	
		.394 x 1.575	18	●	●
		.472 x 1.772	19	●	●
		.630 x 1.890	20	●	●
		.709 x 1.890	21		
		.787 x 1.968	22	●	●
		.984 x 2.205	23	●	
		1.260 x 2.362	24	●	
		1.575 x 2.756	25		
		1.968 x 3.150	26		
		2.480 x 3.543	27		
Whistle Notch DIN1835E		.236 x 1.417	28	●	
		.315 x 1.417	29	●	
		.394 x 1.575	30	●	●
		.472 x 1.772	31	●	●
		.630 x 1.890	32	●	●
		.709 x 1.890	33		
		.787 x 1.968	34	●	●
		.984 x 2.205	35	●	
		1.260 x 2.362	36	●	
		1.575 x 2.756	37		
Whistle Notch DIN6535HE		.236 x 1.417	38	●	
		.315 x 1.417	39	●	
		.394 x 1.575	40	●	●
		.472 x 1.772	41	●	●
		.630 x 1.890	42	●	●
		.709 x 1.890	43		
		.787 x 1.968	44	●	●
DIN228AK		CM1	45		
		CM2	46	●	
		CM3	47		
		CM4	48		
DIN228BK		CM1	49		
		CM2	50	●	
		CM3	51		
		CM4	52		

● Recommended design

STANDARD GUN DRILL DRIVERS FOR GUN DRILL MACHINES

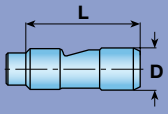
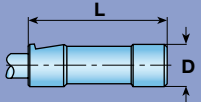
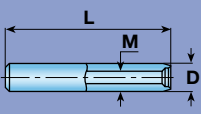
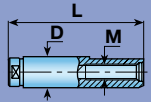
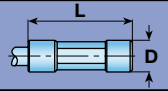
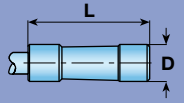
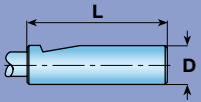
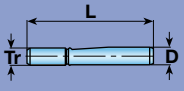
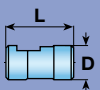
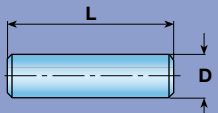
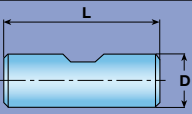
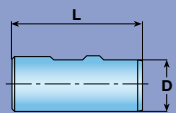
Driver type	Drawing	D x L	Driver Code	Carbide Tipped Gun Drills	Solid Carbide Gun Drills
Central clamping surface 15°		.236 x 1.181	53		•
		.394 x 1.575	54	•	•
		.630 x 1.772	55	•	
		.750 x 2.748	56	•	
		.984 x 2.756	57	•	
		1.00 x 2.748	58	•	
		1.25 x 2.748	59	•	
1.50 x 2.748	60				
Frontal clamping surface 15°		.630 x 1.968	61	•	
Cylindrical with thread		.394 x 1.968 M6X0.5	62		•
		.394 x 2.362 M6X0.5	63	•	
		.500 x 1.968 M6x0.5	64		•
		.630 x 3.150 M10X1	65	•	•
		.984 x 3.937 M16x1.5	66	•	
		1.417 x 4.724 M24x1.5	67		
VDI design		.394 x 2.677 M6x0.5	68	•	
		.630 x 3.543 M10x1	69	•	•
		.984 x 4.409 M16x1.5	70	•	
		1.417 x 5.315 M24x1.5	71		
Central clamping hexagonal		.984 x 2.756	72	•	
		1.26 x 2.756	73	•	
Central clamping tapered		.500 x 1.500	74	•	•
		.630 x 2.756	75		
		.750 x 2.748	76	•	
		.787 x 2.756	77		
Frontal clamping surface 2°		.500 x 1.500	78	•	
		.750 x 2.748	79	•	
		1.00 x 2.748	80	•	
		1.00 x 3.937	81	•	
		1.25 x 2.748	82	•	
		1.25 x 3.937	83	•	
		1.50 x 2.748	84		
1.50 x 3.937	85				
Trapezoidal thread		.630 x 4.409 Tr 16x1.5	86	•	
		.787 x 4.960 Tr 20x2	87	•	
		1.102 x 4.960 Tr 28x2	88	•	
		1.417 x 6.378 Tr 36x2	89		
Spraymist driver		.630 x 1.575	90	•	
		.984 x 1.968	91	•	
		1.378 x 2.362	92	•	
Cylindrical DIN1835A DIN6535HA		.500 x 1.781	94	•	
		.750 x 2.031	95	•	
		1.00 x 2.281	96	•	
		1.25 x 2.281	97	•	
Weldon DIN1835B		.500 x 1.781	98	•	
		.750 x 2.031	99	•	
DIN6535HB		1.00 x 2.281	100	•	
		1.25 x 2.281	101	•	

• Recommended design



BRAZED GUN DRILLS

BRAZED GUN DRILLS

All Ingersoll brazed gun drills are made to order. Standard gun drill components, carbide tips, extension tubes and drivers are kept in stock.

STANDARD DESIGN

- Standard diameters:
 - \emptyset .098" to .787" available in .004" increments
 - \emptyset .788" to 1.260" available in .039" increments
- Standard sub-micron carbide Grade (K15)
- Standard inch sizes in stock:
 - 1/4, 7/16, 3/8, 1/2, 9/16, 5/8, 3/4
- Standard pad form = G-Form
(Standard inch sizes = E-Form)
- Standard back taper (0,07%)
- Standard sharpening
- Uncoated
- Standard driver

SEMI-STANDARD DESIGN

- Out of standard diameter range
- Any other pad form from the catalog other than G or E
- Special surface finish
- Any coating

SPECIAL DESIGN

- Any non-catalog specification

SOLID CARBIDE GUN DRILLS

SOLID CARBIDE GUN DRILLS

All Ingersoll solid carbide gun drills are made to order. Standard solid carbide gun drills and drivers are kept in stock.

STANDARD DESIGN

- Standard sub-micron carbide grade (K15)
- Standard pad form = G-Form
- Standard back taper (0,07%)
- Standard sharpening
- Uncoated
- Standard driver

SEMI-STANDARD DESIGN

- Any other pad form from the catalog
- Special surface finish
- Coating

SPECIAL DESIGN

- Any non-catalog specifications

GUN DRILL REQUEST FOR QUOTATION FORM

QUOTATION FORM

CUSTOMER

Customer Number
Company Name
Address
Contact Person

THE PIECE PART

Name
Part Number
Hole Diameter
Tolerance
Surface Finish (Ra, Rz,...)
Concentricity (.001"/1.0")
Straightness (.001"/1.0")

Hole Depth

Hole Type (Check all that apply)			
Blind Hole	<input type="checkbox"/>	Through Hole	<input type="checkbox"/>
Angled entry	<input type="checkbox"/>	Angled exit	<input type="checkbox"/>
Drilling from solid	<input type="checkbox"/>	Core drill	<input type="checkbox"/>
Cross holes	<input type="checkbox"/>	Other (text)	

Material (Din material, spec etc.)			
Steel	<input type="checkbox"/>	Iron	<input type="checkbox"/>
Aluminum	<input type="checkbox"/>	Stainless steel	<input type="checkbox"/>
Nickel	<input type="checkbox"/>	Other	<input type="checkbox"/>
Hardness			
Long chips	<input type="checkbox"/>	Short chips	<input type="checkbox"/>

Application				
Workpiece	Stationary	<input type="checkbox"/>	Rotating	<input type="checkbox"/>
Tool	Stationary	<input type="checkbox"/>	Rotating	<input type="checkbox"/>

THE MACHINE

Machine Type/Model			
Power	[hp/Kw]		
Rigidity:	Good <input type="checkbox"/>	Average <input type="checkbox"/>	Poor <input type="checkbox"/>

Cutting Data		Max Possible	Current
Cutting speed "Vc" (SFM)			
Revolutions per minute			
Feed "f" (in/rev)			
Feed "F" (in/min)			

Drill Guide Method	Internal Dia.	Tolerance
Pre-Drilled pilot hole		
Bushing		

Coolant				
Pressure "P" (psi)				
Flow Rate (gal/min)				
Neat Oil	<input type="checkbox"/>	Soluable	<input type="checkbox"/>	%

Additional Information

Inquiry Number	
Inquiry Date	
Quantities Requested	

THE TOOL

Tool Type	Carbide Tipped	<input type="checkbox"/>
Unknown	Solid Carbide	<input type="checkbox"/>
Single Lipped	Double Lipped	<input type="checkbox"/>
Customer Drawing No.		

Tool Diameter	[in/mm]		
Tolerance	h5 <input type="checkbox"/>	Other	<input type="checkbox"/>

Coating of the Carbide Tip			
Uncoated	<input type="checkbox"/>	TiAlN	<input type="checkbox"/>
TiN	<input type="checkbox"/>	AlTiN	<input type="checkbox"/>
TiCN	<input type="checkbox"/>	Unknown	<input type="checkbox"/>
TiN + TiCN	<input type="checkbox"/>	Other	

Carbide Tip Length	Other
Standard	<input type="checkbox"/>



Overall Length	[in/mm]
Flute Length	[in/mm]

Driver
List Std catalog number
Other Length x Diameter
Driver Extension L x Dia

Pad Forms	
G <input type="checkbox"/>	A <input type="checkbox"/>
E <input type="checkbox"/>	B <input type="checkbox"/>
C <input type="checkbox"/>	H <input type="checkbox"/>
D <input type="checkbox"/>	I <input type="checkbox"/>

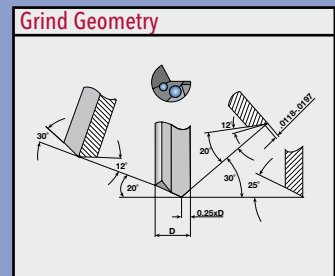

Std grind for diameters from .055" thru .157"					
-1=40	-2=30	d=D/4			
-1=30	-2=15	-3=35	-1=0	-2=30	b=0

Std grind for diameters from .158" thru 1.260"					
-1=30	-2=20	d=D/4			
-1=12	-2=12	-3=25	-1=25	-2=30	b=0,3/0,5

Other					
-1=	-2=	-3=	-1=	-2=	b=

DEEP HOLE BTA-STYLE INDEXABLE DRILLS

- Exceptional hole tolerances
 - Excellent surface finish
 - Superior hole straightness
 - Precision concentricity
-
- BTA cartridge-style indexable drills
 - TBTA-A & TBTA-B for small diameters
 - TBTA-C for economy on standard tolerances
 - TBTA-D for high productivity
 - TBTA-L for large diameters
 - BTA brazed
 - BTA reamers
 - Tubes
 - Technical Information



INSERTS FOR TBTA INDEXABLE DRILLS 3.../5.../7...

INSERT NPMX

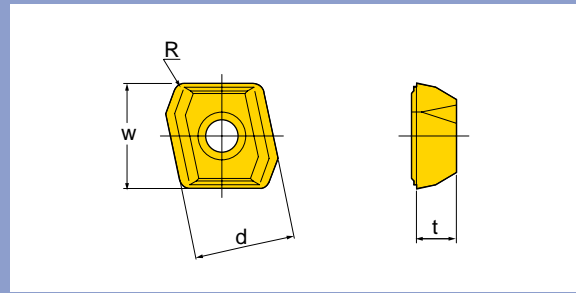

Designation	Dimension				Pocket			Grade IN2005	Screw
	d	t	R	W	Center	Inner	Outer		
NPMX 0803RB	0.315	0.125	0.031	0.329	○	○	○	☉	CSTB2.2
NPMX 0803RG	0.315	0.125	0.031	0.329	○	○	○	☉	CSTB2.2

For use in holders TBTA3_SE4, TBTA3_S11, TBTA3_DE4, TBTA5_SE4, TBTA5_S11, TBTA5_DE4, TBTA7_SE4, and TBTA7_S11, see pages 597 - 599, 603 - 605, 608, and 609.

○ = P ● = M ● = K ● = N ● = S

INSERT TPMX

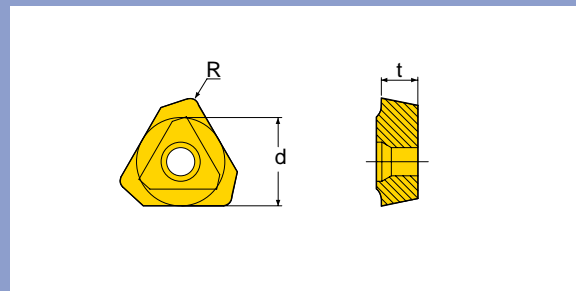

Designation	Dimension			Pocket			Grade IN2005	Screw
	d	t	R	Center	Inner	Outer		
TPMX 1403RB	0.013	0.138	0.016	○	○	○	☉	CSTB2.5
TPMX 1403RG	0.013	0.138	0.031	○	○	○	☉	CSTB2.5
TPMX 1704RB	0.016	0.157	0.016	○	○	○	☉	CSTB3.5D
TPMX 1704RG	0.016	0.157	0.031	○	○	○	☉	CSTB3.5D
TPMX 2405RB	0.022	0.217	0.016	○	○	○	☉	CSTB4M
TPMX 2405RG	0.022	0.217	0.047	○	○	○	☉	CSTB4M
TPMX 2807RB	0.026	0.295	0.031	○	○	○	☉	CSTB5
TPMX 2807RG	0.026	0.295	0.063	○	○	○	☉	CSTB5

For use in holders TBTA3_SE4, TBTA3_S11, TBTA3_DE4, TBTA5_SE4, TBTA5_S11, TBTA5_DE4, TBTA7_SE4, & TBTA7_S11, see pages 597 - 599, 603 - 605, 608, and 609.

○ = P ● = M ● = K ● = N ● = S

PADS FOR TBTA INDEXABLE DRILLS 3.../5.../7...

PAD FOR TBTA 3.../5.../7...

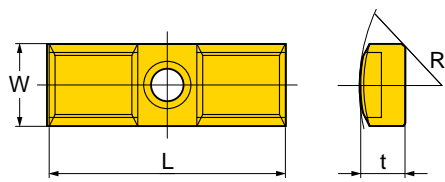

Guide Pad

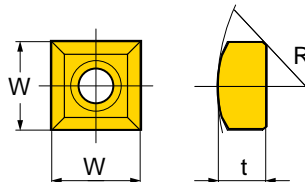

Guide Pad Protector

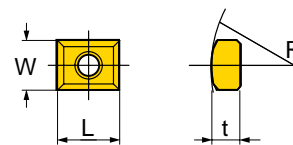

Sub Pad

Type	Designation	Dimension				Screw
		W	t	L	r	
Guide pad	PAD-GC08	0.315	0.177	0.984	0.689	CSTB3S
	PAD-GC10	0.394	0.236	1.378	0.787	CSTB4S
	PAD-GC14	0.551	0.295	1.575	0.984	CSTA5S
	PAD-GC18	0.709	0.354	1.575	1.181	LS1206S
Guide pad protector	PAD-P08	0.315	0.177	0.315	0.689	CSTB3S
	PAD-P10	0.394	0.236	0.394	0.787	CSTB4S
	PAD-P14	0.551	0.295	0.551	0.984	CSTA5S
	PAD-P18	0.709	0.354	0.709	1.181	LS1206S
Sub pad	PAD-S08	0.315	0.177	0.394	0.689	CSTB3S
	PAD-S10	0.394	0.197	0.394	1.142	CSTB3S
	PAD-S14	0.551	0.276	0.787	1.772	CCSTA5S

For use in holders TBTA3_SE4, TBTA3_S11, TBTA3_DE4, TBTA5_SE4, TBTA5_S11, TBTA5_DE4, TBTA7_SE4, & TBTA7_S11, see pages 597 - 599, 603 - 605, 608, and 609.

CARTRIDGE FOR TBTA INDEXABLE DRILLS 3.../5.../7...

CARTRIDGE FOR TBTA 3.../5.../7...

Outer

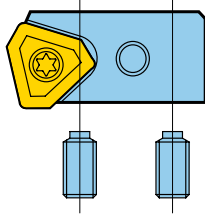

Inner & center

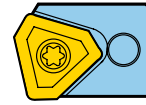

	Designation	Adjusting Screw	Wrench	Lock Screw	Wrench	Insert
Outer	PERC 05R	AS0003-5	H1.5	LS1803RH	H2	NPMX 0803xx
	PERC 402-04	AS0004-8	H2	LS1803.5RH	H2.5	NPMX 1403xx
	PERC 402-32	AS0005-10	H2.5	LS1805RH	H3	NPMX 1704xx
	PERC 402-43	AS0005-15	H2.5	LS1806RH	H4	NPMX 2405xx
	PERC 402-63	AS0006-15	H3	LS1806RH	H4	NPMX 2807xx
Inner & Center	CENC 05R	-	-	CSTB3	T9	NPMX 0803xx
	CENC 402-04	-	-	CSTB3.5	T15	NPMX 1403xx
	CENC 402-32	-	-	CSTA5	T15	NPMX 1704xx
	CENC 402-43	-	-	LS1206	H3	NPMX 2405xx
	CENC 402-63	-	-	LS1206	H3	NPMX 2807xx

For use in holders TBTA3_SE4, TBTA3_S11, TBTA3_DE4, TBTA5_SE4, TBTA5_S11, TBTA5_DE4, TBTA7_SE4, & TBTA7_S11, see pages 597 - 599, 603 - 605, 608, and 609.

DIA PLUS KITS FOR TBTA INDEXABLE DRILLS 3... /5... /7...

'DIA PLUS' KITS FOR TBTA 3.../ 5.../ 7...

With 'Dia Plus' kits BTA indexable drills can increase hole size by up to 5 mm beyond target drill diameter.

'Dia Plus' kits are available for cartridges and guide pads.

CARTRIDGE

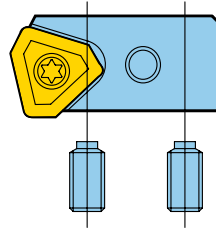

Cartridge	Dimension				
	D + 0.039	D + 0.079	D + 0.118	D + 0.157	D + 0.197
PERC 05	PERC05R+0.039	PERC05R+0.079			
PERC 402-04	PERC402-04+0.039	PERC402-04+0.079	PERC402-04+0.118		
PERC 402-32	PERC402-32+0.039	PERC402-32+0.079	PERC402-32+0.118	PERC402-32+0.157	
PERC 402-43	PERC402-43+0.039	PERC402-43+0.079	PERC402-43+0.118	PERC402-43+0.157	PERC402-43+0.197
PERC 402-63	PERC402-63+0.039	PERC402-63+0.079	PERC402-63+0.118	PERC402-63+0.157	PERC402-63+0.197

For use in holders TBTA3_SE4, TBTA3_S11, TBTA3_DE4, TBTA5_SE4, TBTA5_S11, TBTA5_DE4, TBTA7_SE4, & TBTA7_S11, see [pages 597 - 599, 603 - 605, 608, and 609](#).

GUIDE PAD

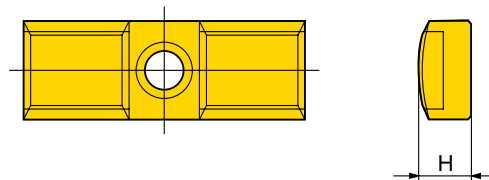

Guide Pad	Dimension									
	D + 0.039	H	D + 0.079	H	D + 0.118	H	D + 0.157	H	D + 0.197	H
PAD-GC08	PAD-GC08+0.039	0.197	PAD-GC08+0.079	0.217	PAD-GC08+0.118	0.236				
PAD-GC10	PAD-GC10+0.039	0.256	PAD-GC10+0.079	0.276	PAD-GC10+0.118	0.295	PAD-GC10+0.157	0.315		
PAD-GC14	PAD-GC14+0.039	0.315	PAD-GC14+0.079	0.335	PAD-GC14+0.118	0.354	PAD-GC14+0.157	0.374	PAD-GC14+0.197	0.394
PAD-GC18	PAD-GC18+0.039	0.374	PAD-GC18+0.079	0.394	PAD-GC18+0.118	0.413	PAD-GC18+0.157	0.433	PAD-GC18+0.197	0.453

For use in holders TBTA3_SE4, TBTA3_S11, TBTA3_DE4, TBTA5_SE4, TBTA5_S11, TBTA5_DE4, TBTA7_SE4, & TBTA7_S11, see [pages 597 - 599, 603 - 605, 608, and 609](#).

BTA INDEXABLE DRILL TBTA3 - 3 CARTRIDGE SYSTEM

SINGLE TUBE SYSTEM - OUTER FOUR START THREAD

Diameter
1.496 - 4.212

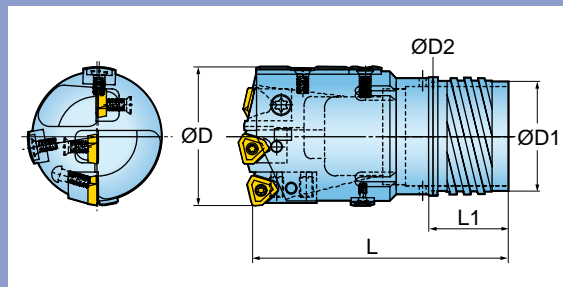

Designation	D	L	Dimension			Tube	
			l1	d1	d2	Part	Diameter
TBTA3-x.xxxSE4-33	1.496 - 1.559	3.35	1.20	1.063	1.063	BTSI 033	1.299
TBTA3-x.xxxSE4-36	1.559 - 1.693	3.35	1.20	1.181	1.181	BTSI 036	1.417
TBTA3-x.xxxSE4-39	1.693 - 1.850	3.74	1.20	1.299	1.299	BTSI 039	1.535
TBTA3-x.xxxSE4-43	1.851 - 2.035	3.74	1.20	1.417	1.417	BTSI 043	1.693
TBTA3-x.xxxSE4-47	2.036 - 2.213	3.94	1.36	1.555	1.555	BTSI 047	1.850
TBTA3-x.xxxSE4-51	2.213 - 2.386	4.33	1.36	1.713	1.713	BTSI 051	2.008
TBTA3-x.xxxSE4-56	2.386 - 2.559	4.33	1.36	1.870	1.870	BTSI 056A	2.205
TBTA3-x.xxxSE4-56	2.559 - 2.637	5.91	2.44	1.850	1.850	BTSI 056B	2.205
TBTA3-x.xxxSE4-62	2.638 - 2.874	5.91	2.44	2.087	2.087	BTSI 062	2.441
TBTA3-x.xxxSE4-68	2.874 - 3.149	5.91	2.44	2.283	2.283	BTSI 068	2.677
TBTA3-x.xxxSE4-75	3.150 - 3.425	7.09	3.23	2.520	2.520	BTSI 075	2.953
TBTA3-x.xxxSE4-82	3.425 - 3.937	7.09	3.23	2.795	2.795	BTSI 082	3.228
TBTA3-x.xxxSE4-94	3.937 - 4.212	7.09	3.23	3.268	3.268	BTSI 094	3.701

For inserts, see [page 593](#).
Operating guidelines on [page 714](#).

BTA INDEXABLE DRILL TBTA3 - 3 CARTRIDGE SYSTEM

SINGLE TUBE SYSTEM - INNER SINGLE START THREAD

Diameter
1.496 - 4.212

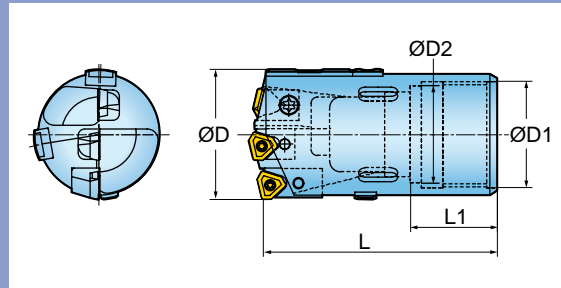

Designation	D	Dimension				Tube	
		L	l1	d1	d2	Part	Diameter
TBTA3-x.xxxSI1-33	1.496 - 1.574	3.15	1.57	1.181	1.063	BTSE 033	1.299
TBTA3-x.xxxSI1-36	1.575 - 1.732	3.15	1.57	1.299	1.181	BTSE 036	1.417
TBTA3-x.xxxSI1-39	1.732 - 1.850	3.54	1.57	1.457	1.339	BTSE 039	1.535
TBTA3-x.xxxSI1-43	1.850 - 2.047	3.54	1.57	1.614	1.457	BTSE 043	1.693
TBTA3-x.xxxSI1-47	2.047 - 2.244	3.94	1.57	1.732	1.575	BTSE 047	1.850
TBTA3-x.xxxSI1-51	2.244 - 2.401	4.33	1.57	1.929	1.772	BTSE 051	2.008
TBTA3-x.xxxSI1-56	2.402 - 2.677	4.33	1.57	2.087	1.929	BTSE 056	2.205
TBTA3-x.xxxSI1-62	2.677 - 2.952	4.72	1.57	2.323	2.126	BTSE 062	2.441
TBTA3-x.xxxSI1-68	2.953 - 3.189	5.91	2.76	2.559	2.362	BTSE 068	2.677
TBTA3-x.xxxSI1-75	3.189 - 3.582	5.91	2.76	2.795	2.598	BTSE 075	2.953
TBTA3-x.xxxSI1-82	3.583 - 3.897	5.91	2.76	3.110	2.913	BTSE 082	3.228
TBTA3-x.xxxSI1-94	3.898 - 4.212	5.91	2.76	3.543	3.346	BTSE 094	3.701

For inserts, see [page 593](#).
Operating guidelines on [page 714](#).

BTA INDEXABLE DRILL TBTA3 - 3 CARTRIDGE SYSTEM

DOUBLE TUBE SYSTEM - OUTER FOUR START THREAD

Diameter
1.496 - 4.212

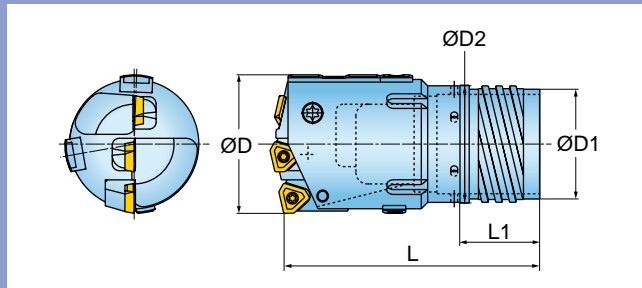

Designation	D	L	Dimension			Tube		
			l1	d1	d2	Outer Tube	Inner Tube	Diameter
TBTA3-x.xxxDE4-35.5	1.496 - 1.559	3.35	1.20	1.181	1.299	BTDO 035.5	BTDI 026	1.398
TBTA3-x.xxxDE4-39	1.559 - 1.693	3.35	1.20	1.299	1.417	BTDO 039	BTDI 029	1.535
TBTA3-x.xxxDE4-42.5	1.693 - 1.850	3.74	1.20	1.417	1.535	BTDO 042.5	BTDI 032	1.673
TBTA3-x.xxxDE4-46.5	1.851 - 2.035	3.74	1.36	1.555	1.693	BTDO 046.5	BTDI 035	1.831
TBTA3-x.xxxDE4-51	2.036 - 2.213	3.94	1.36	1.713	1.850	BTDO 051	BTDI 039	2.008
TBTA3-x.xxxDE4-55.5	2.213 - 2.559	4.33	1.36	1.870	2.008	BTDO 055.5	BTDI 043A	2.185
TBTA3-x.xxxDE4-56	2.559 - 2.637	5.91	2.44	1.850	2.047	BTDO 056	BTDI 043B	2.205
TBTA3-x.xxxDE4-62	2.638 - 2.874	5.91	2.44	2.087	2.283	BTDO 062	BTDI 048	2.441
TBTA3-x.xxxDE4-68	2.874 - 3.149	5.91	2.44	2.283	2.480	BTDO 068	BTDI 053	2.677
TBTA3-x.xxxDE4-75	3.150 - 3.425	7.09	3.23	2.520	2.756	BTDO 075	BTDI 059	2.953
TBTA3-x.xxxDE4-82	3.425 - 3.937	7.09	3.23	2.795	3.031	BTDO 082	BTDI 066	3.228
TBTA3-x.xxxDE4-94	3.937 - 4.212	7.09	3.23	3.268	3.504	BTDO 094	BTDI 078	3.701

For inserts, see [page 593](#).
Operating guidelines on [page 714](#).

BTA INDEXABLE DRILL TBTA3 - 3 CARTRIDGE SYSTEM

ASSEMBLY OF TBTA3 SERIES

Diameter
1.496 - 2.165

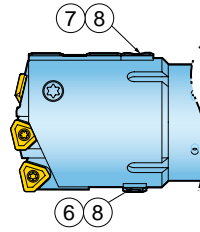
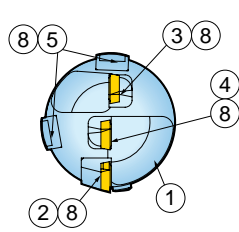

1. Head shank
2. Outer cartridge
3. Inner cartridge
4. Center cartridge
5. Guide pad
6. Sub guide pad
7. Guide pad protector
8. Lock screw

Parts		Diameter				
		1.496 - 1.574	1.575 - 1.771	1.772 - 1.889	1.890 - 2.047	2.047 - 2.165
Cartridge	Outer	PERC 05R	PERC 402-04	PERC 402-04	PERC 402-04	PERC 402-32
	Adjust Screw	AS0003-5	AS0004-8	AS0004-8	AS0004-8	AS0005-10
	Wrench	H1.5	H2	H2	H2	H2.5
	Screw	LS1803RH	LS1803.5RH	LS1803.5RH	LS1803.5RH	LS1805RH
	Wrench	H2	H2.5	H2.5	H2.5	H3
	Inner	CENC 05R	CENC 05R	CENC 05R	CENC 402-04	CENC 402-04
	Screw	CSTB3	CSTB3	CSTB3	CSTB3.5	CSTB3.5
	Wrench	T9	T9	T9	T15	T15
	Center	CENC 05R	CENC 05R	CENC 402-04	CENC 402-04	CENC 402-04
	Screw	CSTB3	CSTB3	CSTB3.5	CSTB3.5	CSTB3.5
Wrench	T9	T9	T15	T15	T15	
Insert	Outer	NPMX 0803RG	TPMX 1403RG	TPMX 1403RG	TPMX 1403RG	TPMX 1704RG
	Screw	CSTB2.2	CSTB2.5	CSTB2.5	CSTB2.5	CSTB3.5D
	Wrench	T7	T8	T8	T8	T9
	Inner	NPMX 0803RG	NPMX 0803RG	NPMX 0803RG	TPMX 1403RG	TPMX 1403RG
	Screw	CSTB2.2	CSTB2.2	CSTB2.2	CSTB2.5	CSTB2.5
	Wrench	T7	T7	T7	T8	T8
	Center	NPMX 0803RG	NPMX 0803RG	TPMX 1403RG	TPMX 1403RG	TPMX 1403RG
	Screw	CSTB2.2	CSTB2.2	CSTB2.5	CSTB2.5	CSTB2.5
Wrench	T7	T7	T8	T8	T8	
Pad	Guide Pad	PAD-GC08	PAD-GC08	PAD-GC10	PAD-GC10	PAD-GC10
	Screw	CSTB3S	CSTB3S	CSTB4S	CSTB4S	CSTB4S
	Wrench	T9	T9	T15	T15	T15
	Guide Pad Protector	PAD-P08	PAD-P08	PAD-P10	PAD-P10	PAD-P10
	Screw	CSTB3S	CSTB3S	CSTB4S	CSTB4S	CSTB4S
	Wrench	T9	T9	T15	T15	T15
	Sub Guide Pad	PAD-S08	PAD-S08	PAD-S08	PAD-S08	PAD-S08
	Screw	CSTB3S	CSTB3S	CSTB3S	CSTB3S	CSTB3S
Wrench	T9	T9	T9	T9	T9	

BTA INDEXABLE DRILL TBTA3 - 3 CARTRIDGE SYSTEM

ASSEMBLY OF TBTA3 SERIES

Diameter
2.165 - 3.070

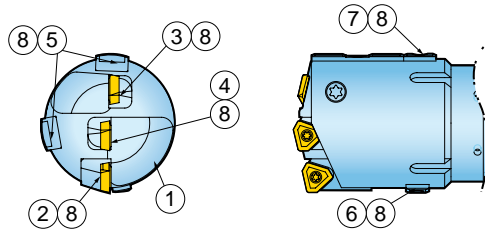

1. Head shank
2. Outer cartridge
3. Inner cartridge
4. Center cartridge
5. Guide pad
6. Sub guide pad
7. Guide pad protector
8. Lock screw

Parts		Diameter				
		2.165 - 2.283	2.283 - 2.362	2.362 - 2.519	2.520 - 2.677	2.677 - 3.070
Cartridge	Outer	PERC 402-32	PERC 402-32	PERC 402-32	PERC 402-43	PERC 402-32
	Adjust Screw	AS0005-10	AS0005-10	AS0005-10	AS0005-15	AS0005-10
	Wrench	H2.5	H2.5	H2.5	H2.5	H2.5
	Screw	LS1805RH	LS1805RH	LS1805RH	LS1806RH	LS1805RH
	Wrench	H3	H3	H3	H4	H4
	Inner	CENC 402-04	CENC 402-32	CENC 402-32	CENC 402-32	CENC 402-43
	Screw	CSTB3.5	CSTA5	CSTA5	CSTA5	LS1206
	Wrench	T15	T15	T15	T15	H3
	Center	CENC 402-32	CENC 402-32	CENC 402-32	CENC 402-32	CENC 402-43
	Screw	CSTA5	CSTA5	CSTA5	CSTA5	LS1206
Wrench	T15	T15	T15	T15	H3	
Insert	Outer	TPMX 1704RG	TPMX 1704RG	TPMX 1704RG	TPMX 2405RG	TPMX 1704RG
	Screw	CSTB3.5D	CSTB3.5D	CSTB3.5D	CSTB4M	CSTB3.5D
	Wrench	T9	T9	T9	T15	T9
	Inner	TPMX 1403RG	TPMX 1704RG	TPMX 1704RG	TPMX 1704RG	TPMX 2405RG
	Screw	CSTB2.5	CSTB3.5D	CSTB3.5D	CSTB3.5D	CSTB4M
	Wrench	T8	T9	T9	T9	T15
	Center	TPMX 1704RG	TPMX 1704RG	TPMX 1704RG	TPMX 1704RG	TPMX 2405RG
	Screw	CSTB3.5D	CSTB3.5D	CSTB3.5D	CSTB3.5D	CSTB4M
Wrench	T9	T9	T9	T9	T15	
Pad	Guide Pad	PAD-GC10	PAD-GC10	PAD-GC14	PAD-GC14	PAD-GC14
	Screw	CSTB4S	CSTB4S	CSTA5S	CSTA5S	CSTA5S
	Wrench	T15	T15	T15	T15	T15
	Guide Pad Protector	PAD-P10	PAD-P10	PAD-P14	PAD-P14	PAD-P14
	Screw	CSTB4S	CSTB4S	CSTA5S	CSTA5S	CSTA5S
	Wrench	T15	T15	T15	T15	T15
	Sub Guide Pad	PAD-S08	PAD-S08	PAD-S08	PAD-S10	PAD-S10
	Screw	CSTB3S	CSTB3S	CSTB3S	CSTB3S	CSTB3S
Wrench	T9	T9	T9	T9	T9	

BTA INDEXABLE DRILL TBTA3 - 3 CARTRIDGE SYSTEM

ASSEMBLY OF TBTA3 SERIES

Diameter
3.071 - 4.212

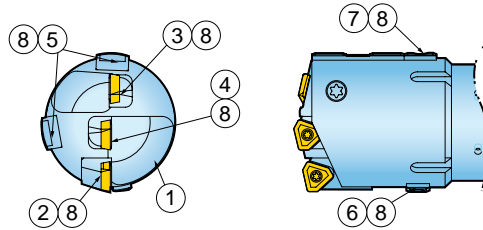

1. Head shank
2. Outer cartridge
3. Inner cartridge
4. Center cartridge
5. Guide pad
6. Sub guide pad
7. Guide pad protector
8. Lock screw

Parts		Diameter			
		3.071 - 3.346	3.346 - 3.622	3.622 - 3.897	3.898 - 4.212
Cartridge	Outer	PERC 402-43	PERC 402-63	PERC 402-43	PERC 402-63
	Adjust Screw	AS0005-15	AS0006-15	AS0005-15	AS0006-15
	Wrench	H2.5	H3	H2.5	H3
	Screw	LS1806RH	LS1806RH	LS1806RH	LS1806RH
	Wrench	H4	H4	H4	H4
	Inner	CENC 402-43	CENC 402-43	CENC 402-63	CENC 402-63
	Screw	LS1206	LS1206	LS1206	LS1206
	Wrench	H3	H3	H3	H3
	Center	CENC 402-43	CENC 402-43	CENC 402-63	CENC 402-63
	Screw	LS1206	LS1206	LS1206	LS1206
Wrench	H3	H3	H3	H3	
Insert	Outer	TPMX 2405RG	TPMX 2807RG	TPMX 2405RG	TPMX 2807RG
	Screw	CSTB4M	CSTB5	CSTB4M	CSTB5
	Wrench	T15	T20	T15	T20
	Inner	TPMX 2405RG	TPMX 2405RG	TPMX 2807RG	TPMX 2807RG
	Screw	CSTB4M	CSTB4M	CSTB5	CSTB5
	Wrench	T15	T15	T20	T20
	Center	TPMX 2405RG	TPMX 2405RG	TPMX 2807RG	TPMX 2807RG
	Screw	CSTB4M	CSTB4M	CSTB5	CSTB5
Wrench	T15	T15	T20	T20	
Pad	Guide Pad	PAD-GC14	PAD-GC14	PAD-GC14	PAD-GC18
	Screw	CSTA5S	CSTA5S	CSTA5S	LS1206S
	Wrench	T15	T15	T15	H3
	Guide Pad Protector	PAD-P14	PAD-P14	PAD-P14	PAD-P18
	Screw	CSTB5S	CSTB5S	CSTA5S	LS1206S
	Wrench	T15	T15	T15	H3
	Sub Guide Pad	PAD-S10	PAD-S10	PAD-S10	PAD-S14
	Screw	CSTB3S	CSTB3S	CSTB3S	CSTA5S
Wrench	T9	T9	T9	T15	

BTA INDEXABLE DRILL TBTA5 - 5 CARTRIDGE SYSTEM

SINGLE TUBE SYSTEM - OUTER FOUR START THREAD

Diameter
4.213 - 6.653

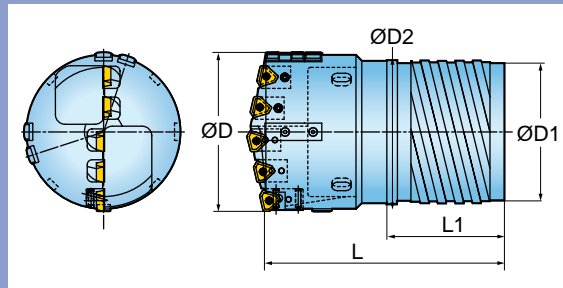

Designation	D	L	Dimension			Tube	
			l1	d1	d2	Part	Diameter
TBTA5-x.xxxSE4-094	4.213 - 4.409	7.09	3.23	3.268	3.504	BTSI 094	3.701
TBTA5-x.xxxSE4-106	4.409 - 4.881	8.07	4.02	3.740	3.976	BTSI 106	4.173
TBTA5-x.xxxSE4-118	4.882 - 5.354	8.07	4.02	4.213	4.449	BTSI 118	4.646
TBTA5-x.xxxSE4-130	5.354 - 5.826	8.07	4.02	4.685	4.921	BTSI 130	5.118
TBTA5-x.xxxSE4-142	5.827 - 6.299	8.86	4.80	5.157	5.394	BTSI 142	5.591
TBTA5-x.xxxSE4-154	6.299 - 6.653	8.86	4.80	5.630	5.866	BTSI 154	6.063

For inserts, see [page 593](#).
Operating guidelines on [page 714](#).

BTA INDEXABLE DRILL TBTA5 - 5 CARTRIDGE SYSTEM

SINGLE TUBE SYSTEM - INNER SINGLE START THREAD

Diameter
4.213 - 6.653

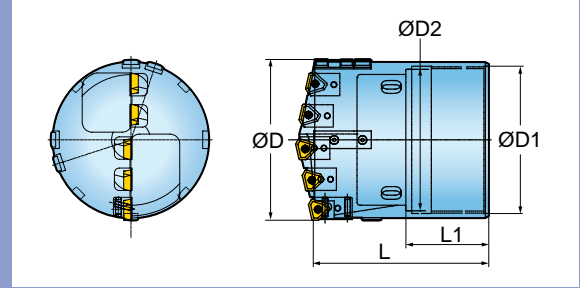

Designation	D	L	Dimension			Tube	
			l1	d1	d2	Part	Diameter
TBTA5-x.xxxSI1-094	4.213 - 4.370	5.91	2.76	3.543	3.346	BTSE 094	3.701
TBTA5-x.xxxSI1-106	4.370 - 4.842	5.91	2.76	4.016	3.819	BTSE 106	4.173
TBTA5-x.xxxSI1-118	4.843 - 5.315	5.91	2.76	4.488	4.291	BTSE 118	4.646
TBTA5-x.xxxSI1-130	5.315 - 5.866	5.91	2.76	4.961	4.764	BTSE 130	5.118
TBTA5-x.xxxSI1-142	5.866 - 6.378	5.91	2.76	5.472	5.276	BTSE 142	5.591
TBTA5-x.xxxSI1-154	6.378 - 6.653	7.48	3.35	5.945	5.709	BTSE 154	6.063

For inserts, see [page 593](#).
Operating guidelines on [page 714](#).

BTA INDEXABLE DRILL TBTA5 - 5 CARTRIDGE SYSTEM

DOUBLE TUBE SYSTEM - OUTER FOUR START THREAD

Diameter
4.213 - 6.653

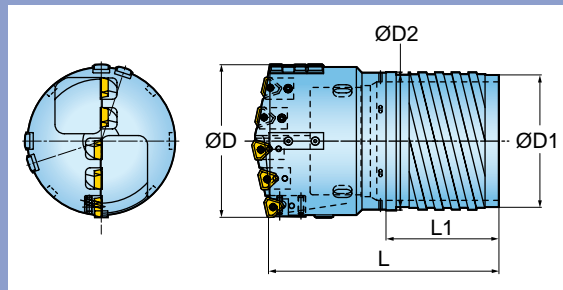

Designation	D	L	Dimension			Tube		
			l1	d1	d2	Outer tube	Inner tube	Diameter
TBTA5-x.xxxDE4-094	4.213 - 4.409	7.09	3.23	3.268	3.504	BTDO 094	BTDI 078	3.701
TBTA5-x.xxxDE4-106	4.409 - 4.881	8.07	4.02	3.740	3.976	BTDO 106	BTDI 090	4.173
TBTA5-x.xxxDE4-118	4.882 - 5.354	8.07	4.02	4.213	4.449	BTDO 118	BTDI 092	4.646
TBTA5-x.xxxDE4-130	5.354 - 5.826	8.07	4.02	4.685	4.921	BTDO 130	BTDI 093	5.118
TBTA5-x.xxxDE4-142	5.827 - 6.299	8.86	4.80	5.157	5.394	BTDO 142	BTDI 094	5.591
TBTA5-x.xxxDE4-154	6.299 - 6.653	8.86	4.80	5.630	5.866	BTDO 154	BTDI 095	6.063

For inserts, see [page 593](#).
Operating guidelines on [page 714](#).

BTA INDEXABLE DRILL TBT A5 - 5 CARTRIDGE SYSTEM

ASSEMBLY OF TBT A5 SERIES

Diameter
4.213 - 5.944

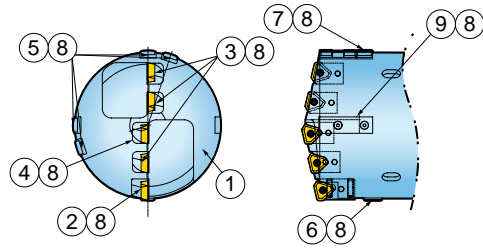

1. Head shank
2. Outer cartridge
3. Inner cartridge
4. Center cartridge
5. Guide pad
6. Sub guide pad
7. Guide pad protector
8. Lock screw
9. Filler

Parts		Diameter			
		4.213 - 4.645	4.646 - 5.354	5.354 - 5.708	5.709 - 5.944
Cartridge	Outer	PERC 402-43	PERC 402-43	PERC 402-43	PERC 402-43
	Adjust Screw	AS0005-15	AS0005-15	AS0005-15	AS0005-15
	Wrench	H2.5	H2.5	H2.5	H2.5
	Screw	LS1806RH	LS1806RH	LS1806RH	LS1806RH
	Wrench	H4	H4	H4	H4
	Inner	CENC 402-32	CENC 402-43	CENC 402-43	CENC 402-43
	Screw	CSTA5	LS1206	LS1206	LS1206
	Wrench	T15	H3	H3	H3
	Center	CENC 402-43	CENC 402-43	CENC 402-63	CENC 402-63
	Screw	LS1206	LS1206	LS1206	LS1206
Wrench	H3	H3	H3	H3	
Insert	Outer	TPMX 2405RG	TPMX 2405RG	TPMX 2405RG	TPMX 2405RG
	Screw	CSTB4M	CSTB4M	CSTB4M	CSTB4M
	Wrench	T15	T15	T15	T15
	Inner	TPMX 1704RG	TPMX 2405RG	TPMX 2405RG	TPMX 2405RG
	Screw	CSTB3.5D	CSTB4M	CSTB4M	CSTB4M
	Wrench	T9	T15	T15	T15
	Center	TPMX 2405RG	TPMX 2405RG	TPMX 2807RG	TPMX 2807RG
	Screw	CSTB4M	CSTB4M	CSTB5	CSTB5
Wrench	T15	T15	T20	T20	
Pad	Guide Pad	PAD-GC18	PAD-GC18	PAD-GC18	PAD-GC18
	Screw	LS1206S	LS1206S	LS1206S	LS1206S
	Wrench	H3	H3	H3	H3
	Guide Pad Protector	PAD-P18	PAD-P18	PAD-P18	PAD-P18
	Screw	LS1206S	LS1206S	LS1206S	LS1206S
	Wrench	H3	H3	H3	H3
	Sub Guide Pad	PAD-S14	PAD-S14	PAD-S14	PAD-S14
	Screw	CSTA5S	CSTA5S	CSTA5S	CSTA5S
Wrench	T15	T15	T15	T15	

BTA INDEXABLE DRILL TBTA5 - 5 CARTRIDGE SYSTEM

ASSEMBLY OF TBTA5 SERIES

Diameter
5.945 - 6.653

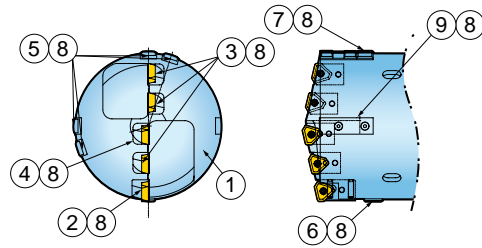

1. Head shank
2. Outer cartridge
3. Inner cartridge
4. Center cartridge
5. Guide pad
6. Sub guide pad
7. Guide pad protector
8. Lock screw
9. Filler

Parts		Diameter			
		5.945 - 6.181	6.181 - 6.417	6.417 - 6.653	
Cartridge	Outer	PERC 402-63	PERC 402-63	PERC 402-63	
	Adjust Screw	AS0006-15	AS0006-15	AS0006-15	
	Wrench	H3	H3	H3	
	Screw	LS1806RH	LS1806RH	LS1806RH	
	Wrench	H4	H4	H4	
	Inner	CENC 402-43	CENC 402-43	CENC 402-63	
	Screw	LS1206	LS1206	LS1206	
	Wrench	H3	H3	H3	
	Center	CENC 402-63	CENC 402-63	CENC 402-63	
	Screw	LS1206	LS1206	LS1206	
	Wrench	H3	H3	H3	
	Insert	Outer	TPMX 2807RG	TPMX 2807RG	TPMX 2807RG
Screw		CSTB5	CSTB5	CSTB5	
Wrench		T20	T20	T20	
Inner		TPMX 2405RG	TPMX 2405RG	TPMX 2807RG	
Screw		CSTB4M	CSTB4M	CSTB5	
Wrench		T15	T15	T20	
Center		TPMX 2807RG	TPMX 2807RG	TPMX 2807RG	
Screw		CSTB5	CSTB5	CSTB5	
Wrench		T20	T20	T20	
Pad		Guide Pad	PAD-GC18	PAD-GC18	PAD-GC18
		Screw	LS1206S	LS1206S	LS1206S
		Wrench	H3	H3	H3
	Guide Pad Protector	PAD-P18	PAD-P18	PAD-P18	
	Screw	LS1206S	LS1206S	LS1206S	
	Wrench	H3	H3	H3	
	Sub Guide Pad	PAD-S14	PAD-S14	PAD-S14	
	Screw	CSTA5S	CSTA5S	CSTA5S	
	Wrench	T15	T15	T15	

BTA INDEXABLE DRILL TBTA7 - 7 CARTRIDGE SYSTEM

SINGLE TUBE SYSTEM - OUTER FOUR START THREAD

Diameter
6.654 - 9.173

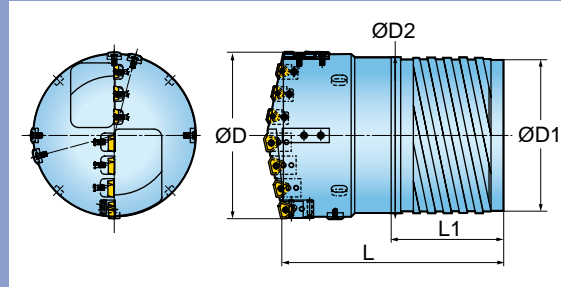

Designation	D	Dimension				Tube	
		L	l1	d1	d2	Part	Diameter
TBTA7-x.xxxSE4-154	6.654 - 6.771	9.06	4.80	5.630	5.866	BTSI 154	6.063
TBTA7-x.xxxSE4-166	6.772 - 7.244	9.06	4.80	6.102	6.339	BTSI 166	6.535
TBTA7-x.xxxSE4-178	7.244 - 7.716	9.84	5.59	6.575	6.811	BTSI 178	7.008
TBTA7-x.xxxSE4-190	7.717 - 8.189	9.84	5.59	7.047	7.283	BTSI 190	7.480
TBTA7-x.xxxSE4-202	8.189 - 8.661	9.84	5.59	7.520	7.756	BTSI 202	7.953
TBTA7-x.xxxSE4-214	8.661 - 9.133	10.63	6.38	7.913	8.189	BTSI 214	8.425
TBTA7-x.xxxSE4-226	9.134 - 9.173	10.63	6.38	8.386	8.661	BTSI 226	8.898

For inserts, see [page 593](#).
Operating guidelines on [page 714](#).

BTA INDEXABLE DRILL TBTA7 - 7 CARTRIDGE SYSTEM

SINGLE TUBE SYSTEM - INNER SINGLE START THREAD

Diameter
6.654 - 9.685

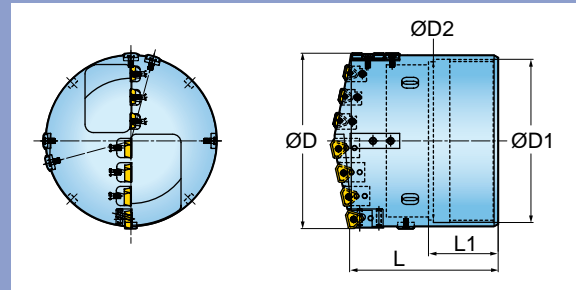

Designation	D	L	Dimension			Tube	
			l1	d1	d2	Part	Diameter
TBTA7-x.xxxSI1-154	6.654 - 6.850	7.48	3.35	5.709	5.945	BTSE 154	6.063
TBTA7-x.xxxSI1-166	6.850 - 7.322	7.48	3.35	6.181	6.417	BTSE 166	6.535
TBTA7-x.xxxSI1-178	7.323 - 7.795	7.48	3.35	6.654	6.890	BTSE 178	7.008
TBTA7-x.xxxSI1-190	7.795 - 8.267	7.48	3.35	7.126	7.362	BTSE 190	7.480
TBTA7-x.xxxSI1-202	8.268 - 8.740	7.48	3.35	7.598	7.835	BTSE 202	7.953
TBTA7-x.xxxSI1-214	8.740 - 9.212	7.48	3.35	8.071	8.307	BTSE 214	8.425
TBTA7-x.xxxSI1-226	9.213 - 9.685	7.48	3.35	8.543	8.780	BTSE 226	8.898

For inserts, see [page 593](#).
Operating guidelines on [page 714](#).

BTA INDEXABLE DRILL TBTA7 - 7 CARTRIDGE SYSTEM

ASSEMBLY OF TBTA7 SERIES

Diameter
6.654 - 8.228

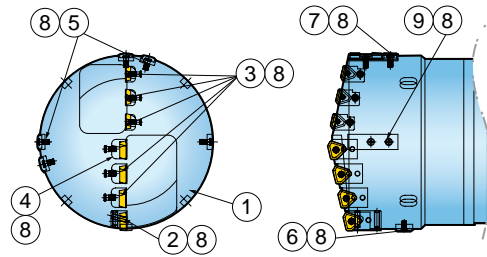

1. Head shank
2. Outer cartridge
3. Inner cartridge
4. Center cartridge
5. Guide pad
6. Sub guide pad
7. Guide pad protector
8. Lock screw
9. Filler

Parts		Diameter			
		6.654 - 7.441	7.441 - 7.756	7.756 - 7.992	7.992 - 8.228
Cartridge	Outer	PERC 402-43	PERC 402-43	PERC 402-43	PERC 402-43
	Adjust Screw	AS0005-15	AS0005-15	AS0005-15	AS0005-15
	Wrench	H2.5	H2.5	H2.5	H2.5
	Screw	LS1806RH	LS1806RH	LS1806RH	LS1806RH
	Wrench	H4	H4	H4	H4
	Inner	CENC 402-43	CENC 402-43	CENC 402-43	CENC 402-43
	Screw	LS1206	LS1206	LS1206	LS1206
	Wrench	H3	H3	H3	H3
	Center	CENC 402-43	CENC 402-63	CENC 402-63	CENC 402-63
	Screw	LS1206	LS1206	LS1206	LS1206
	Wrench	H3	H3	H3	H3
	Insert	Outer	TPMX 2405RG	TPMX 2405RG	TPMX 2405RG
Screw		CSTB4M	CSTB4M	CSTB4M	CSTB4M
Wrench		T15	T15	T15	T15
Inner		TPMX 2405RG	TPMX 2405RG	TPMX 2405RG	TPMX 2405RG
Screw		CSTB4M	CSTB4M	CSTB4M	CSTB4M
Wrench		T15	T15	T15	T15
Center		TPMX 2405RG	TPMX 2807RG	TPMX 2807RG	TPMX 2807RG
Screw		CSTB4M	CSTB5	CSTB5	CSTB5
Wrench	T15	T20	T20	T20	
Pad	Guide Pad	PAD-GC18	PAD-GC18	PAD-GC18	PAD-GC18
	Screw	LS1206S	LS1206S	LS1206S	LS1206S
	Wrench	H3	H3	H3	H3
	Guide Pad Protector	PAD-P18	PAD-P18	PAD-P18	PAD-P18
	Screw	LS1206S	LS1206S	LS1206S	LS1206S
	Wrench	H3	H3	H3	H3
	Sub Guide Pad	PAD-S14	PAD-S14	PAD-S14	PAD-S14
	Screw	CSTA5S	CSTA5S	CSTA5S	CSTA5S
	Wrench	T15	T15	T15	T15

BTA INDEXABLE DRILL TBTA7 - 7 CARTRIDGE SYSTEM

ASSEMBLY OF TBTA7 SERIES

Diameter
8.228 - 8.937

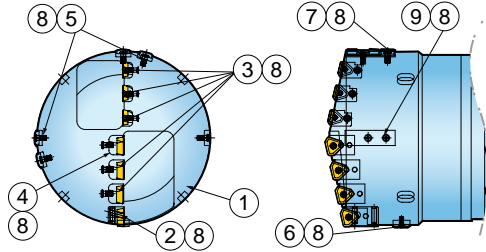

1. Head shank
2. Outer cartridge
3. Inner cartridge
4. Center cartridge
5. Guide pad
6. Sub guide pad
7. Guide pad protector
8. Lock screw
9. Filler

Parts		Diameter		
		8.228 - 8.464	8.465 - 8.700	8.701 - 8.937
Cartridge	Outer	PERC 402-63	PERC 402-63	PERC 402-63
	Adjust Screw	AS0006-15	AS0006-15	AS0006-15
	Wrench	H3	H3	H3
	Screw	L1806RH	L1806RH	L1806RH
	Wrench	H4	H4	H4
	Inner	CENC 402-43	CENC 402-43	CENC 402-43
	Screw	LS1206	LS1206	LS1206
	Wrench	H3	H3	H3
	Center	CENC 402-63	CENC 402-63	CENC 402-63
	Screw	LS1206	LS1206	LS1206
	Wrench	H3	H3	H3
	Insert	Outer	TPMX 2807RG	TPMX 2807RG
Screw		CSTB5	CSTB5	CSTB5
Wrench		T20	T20	T20
Inner		TPMX 2405RG	TPMX 2405RG	TPMX 2405RG
Screw		CSTB4M	CSTB4M	CSTB4M
Wrench		T15	T15	T15
Center		TPMX 2807RG	TPMX 2807RG	TPMX 2807RG
Screw		CSTB5	CSTB5	CSTB5
Wrench		T20	T20	T20
Pad	Guide Pad	PAD-GC18	PAD-GC18	PAD-GC18
	Screw	LS1206S	LS1206S	LS1206S
	Wrench	H3	H3	H3
	Guide Pad Protector	PAD-P18	PAD-P18	PAD-P18
	Screw	LS1206S	LS1206S	LS1206S
	Wrench	H3	H3	H3
	Sub Guide Pad	PAD-S14	PAD-S14	PAD-S14
	Screw	CSTA5S	CSTA5S	CSTA5S
	Wrench	T15	T15	T15

INSERTS FOR TBTA-A FOR SMALL DIAMETERS

INSERTS FOR TBTA-A

NPMX 0802RG

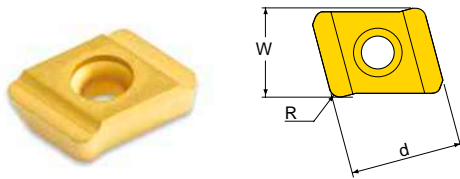

NPMX 0803RG

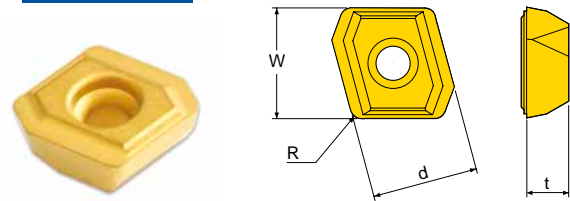

Designation	Dimension				Pocket			Grade IN2005	Screw
	d	t	R	W	Center	Inner	Outer		
NPMX 0802RG	0.335	0.094	0.031	0.256	○	○	○	⊗	CSTB2.2
NPMX 0803RG	0.315	0.125	0.031	0.329		○	○	⊗	CSTB2.2

For use in holders TBTA-A_SE4 and TBTA-A_SI11, pages 613 and 614.

○ = P ● = M ● = K ● = N ● = S

PAD

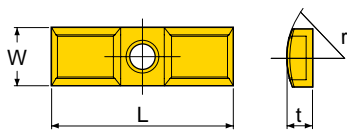

Guide pad

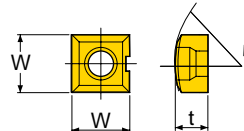

Guide pad protector

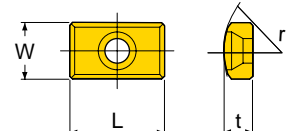

Sub pad

Type	Designation	Dimension				Screw
		W	t	L	r	
Guide pad	PAD-GC08-140	0.315	0.138	0.984	0.551	CSTB 3S
Guide pad protector	PAD-P08-140	0.315	0.138	0.315	0.551	CSTB 3S
Sub pad	PAD-S06	0.236	0.118	0.394	0.315	CSTB 2.2S

For use in holders TBTA-A_SE4 and TBTA-A_SI11, pages 613 and 614.

CARTRIDGES FOR TBTA-A

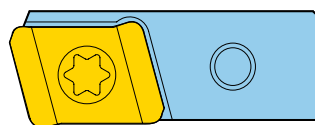

	Designation	Adjust Screw	Wrench	Lock Screw	Wrench	Insert
Outer	PERC 05R	AS0003-5	H1.5	LS1803RH	H2	NPMX 0803xx
	PERC 06R	AS0002.5-5	H1.27	CSTB2.5	H8	NPMX 0802xx
Inner & center	CENC 05R	-	-	CSTB3	T9	NPMX 0803xx
	CENC 06R	-	-	CSTB2.5	T8	NPMX 0802xx

For use in holders TBTA-A_SE4 and TBTA-A_SI11, pages 613 and 614.

BTA INDEXABLE DRILL TBTA-A FOR SMALL DIAMETERS

SINGLE TUBE SYSTEM - OUTER FOUR START THREAD

Diameter
1.142 - 1.496

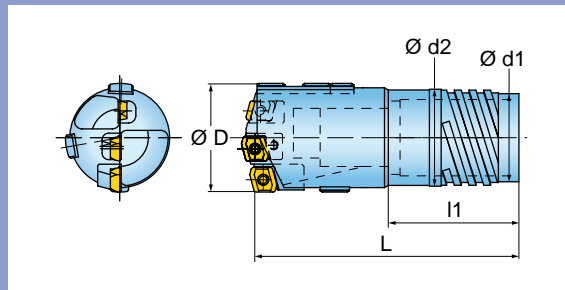

Designation	D	L	Dimension			Tube	
			l1	d1	d2	Part	Diameter
TBTA-Ax.xxxSE4-26	1.142 - 1.220	2.72	0.96	0.827	0.925	BTSI 026	1.024
TBTA-Ax.xxxSE4-28	1.221 - 1.311	2.72	0.96	0.906	1.004	BTSI 028	1.102
TBTA-Ax.xxxSE4-30	1.311 - 1.425	2.72	0.96	1.004	1.102	BTSI 030	1.181
TBTA-Ax.xxxSE4-33	1.426 - 1.496	2.95	1.20	1.063	1.181	BTSI 033	1.299

For inserts, see [page 612](#).
Operating guidelines on [page 714](#).

BTA INDEXABLE DRILL TBTA-A FOR SMALL DIAMETERS

SINGLE TUBE SYSTEM - INNER SINGLE START THREAD

Diameter
1.142 - 1.496

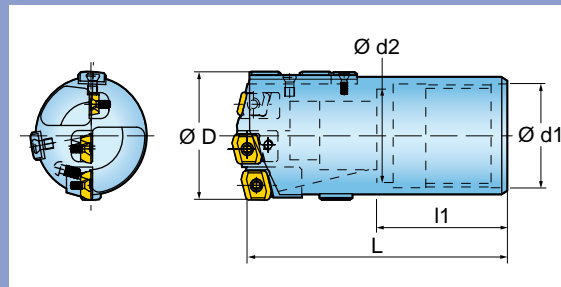

Designation	D	L	Dimension			Tube	
			l1	d1	d2	Part	Diameter
TBTA-Ax.xxxSI1-24	1.142 - 1.181	2.95	0.98	0.866	0.748	BTSE 024	0.945
TBTA-Ax.xxxSI1-26	1.181 - 1.259	2.95	0.98	0.945	0.827	BTSE 026	1.024
TBTA-Ax.xxxSI1-28	1.260 - 1.338	2.95	0.98	1.024	0.906	BTSE 028	1.102
TBTA-Ax.xxxSI1-30	1.339 - 1.456	3.54	1.57	1.063	0.945	BTSE 030	1.181
TBTA-Ax.xxxSI1-33	1.457 - 1.496	3.54	1.57	1.181	1.063	BTSE 033	1.299

For inserts, see [page 612](#).
Operating guidelines on [page 714](#).

BTA INDEXABLE DRILL TBTA-A FOR SMALL DIAMETERS

ASSEMBLY OF TBTA-A SERIES

Diameter
1.142 - 1.496

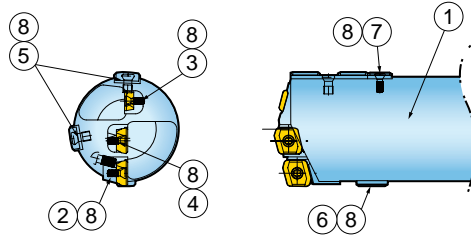

1. Head shank
2. Outer cartridge
3. Inner cartridge
4. Center cartridge
5. Guide pad
6. Sub guide pad
7. Guide pad protector
8. Lock screw

Parts		Diameter		
		1.142 - 1.338	1.339 - 1.378	1.378 - 1.496
Cartridge	Outer	PERC 06R	PERC 06R	PERC 05R
	Adjust Screw	AS0002.5-5	AS0002.5-5	AS0003-5
	Wrench	H1.27	H1.27	H1.5
	Screw	CSTB2.5	CSTB2.5	LS1803RH
	Wrench	T8	T8	H2
	Inner	CENC 06R	CENC 06R	CENC 06R
	Screw	CSTB2.5	CSTB2.5	CSTB2.5
	Wrench	T8	T8	T8
	Center	CENC 06R	CENC 05R	CENC 05R
	Screw	CSTB2.5	CSTB3	CSTB3
	Wrench	T8	T9	T9
	Insert	Outer	NPMX 0802RG	NPMX 0802RG
Screw		CSTB2.2	CSTB2.2	CSTB2.2
Wrench		T7	T7	T7
Inner		NPMX 0802RG	NPMX 0803RG	NPMX 0803RG
Screw		CSTB2.2	CSTB2.2	CSTB2.2
Wrench		T7	T7	T7
Center		NPMX 0802RG	NPMX 0802RG	NPMX 0802RG
Screw		CSTB2.2	CSTB2.2	CSTB2.2
Wrench		T7	T7	T7
Pad	Guide Pad	PAD-GC08-140	PAD-GC08-140	PAD-GC08-140
	Screw	CSTB3S	CSTB3S	CSTB3S
	Wrench	T9	T9	T9
	Guide Pad Protector	PAD-P08-140	PAD-P08-140	PAD-P08-140
	Screw	CSTB3S	CSTB3S	CSTB3S
	Wrench	T9	T9	T9
	Sub Guide Pad	PAD-S06	PAD-S06	PAD-S06
	Screw	CSTB2.2S	CSTB2.2S	CSTB2.2S
	Wrench	T7	T7	T7

INSERT FOR TBTA-B FOR SMALL DIAMETERS

INSERT FOR TBTA-B

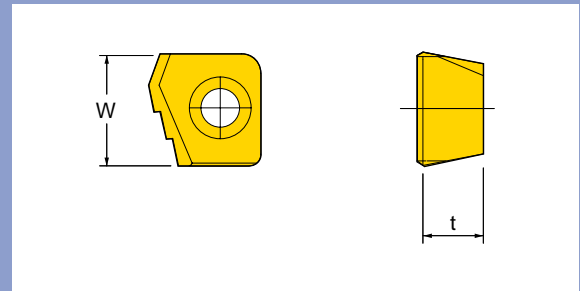

Designation	Dimension		Pocket			Grade IN2005	Screw
	t	W	Center	Inner	Outer		
XPMT 16002UB	0.110	0.374			○	●	CSTAN03-4.5
XPMT 18003UB	0.120	0.433			○	●	CSTAN05-5.5
XPMT 21003UB	0.140	0.512			○	●	CSTAN05-6.5
XPMT 25003UB	0.134	0.571			○	●	CSTA4-7.5

For use in holders TBTA-B_SE4 and TBTA-B_SI1, pages 617 and 618.

○ = P ● = M ● = K ● = N ● = S

PAD

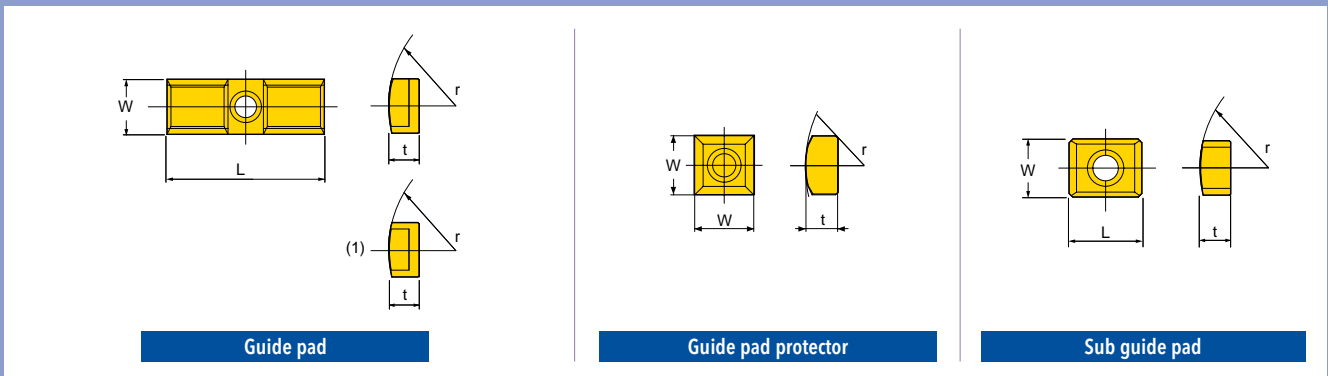

Type	Designation	Dimension				Screw
		W	t	L	r	
Guide pad	PAD-GC06-075	0.236	0.128	0.787	0.295	CSTB2.2S
	PAD-GC06-085	0.236	0.150	0.787	0.335	CSTB2.2S
	PAD-GC06-100	0.236	0.154	0.787	0.394	CSTB2.2S
	PAD-GC08-120	0.315	0.173	0.984	0.472	CSTB3S
Guide pad protector	PAD-P06-075	0.236	0.128	0.236	0.295	CSTB2.2S
	PAD-P06-085	0.236	0.150	0.236	0.335	CSTB2.2S
	PAD-P06-100	0.236	0.154	0.236	0.394	CSTB2.2S
	PAD-P08-120	0.236	0.173	0.236	0.472	CSTB3S
Sub guide pad	PAD-S06	0.236	0.118	0.394	0.315	CSTB2.2S

For use in holders TBTA-B_SE4 and TBTA-B_SI1, pages 617 and 618.

BTA INDEXABLE DRILLS TBTA-B FOR SMALL DIAMETERS

SINGLE TUBE SYSTEM - OUTER FOUR START THREAD

Diameter
0.630 - 1.122

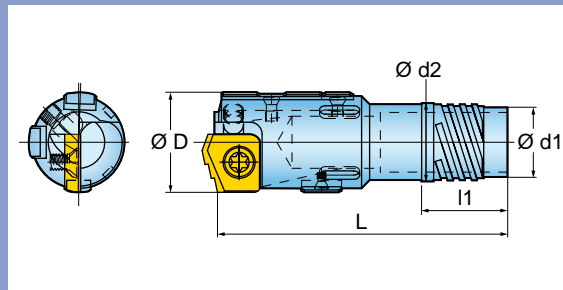

Designation	D	L	Dimension			Tube	
			l1	d1	d2	Part	Diameter
TBTA-Bx.xxxSE4-14	0.630 - 0.657	2.44	0.79	0.425	0.496	BTSI 014	0.551
TBTA-Bx.xxxSE4-15	0.658 - 0.697	2.44	0.79	0.465	0.535	BTSI 015	0.591
TBTA-Bx.xxxSE4-16	0.697 - 0.744	2.44	0.85	0.492	0.571	BTSI 016	0.630
TBTA-Bx.xxxSE4-17	0.744 - 0.787	2.44	0.85	0.531	0.610	BTSI 017	0.669
TBTA-Bx.xxxSE4-18	0.788 - 0.858	2.66	0.85	0.551	0.630	BTSI 018	0.709
TBTA-Bx.xxxSE4-20	0.859 - 0.949	2.66	0.85	0.630	0.709	BTSI 020	0.787
TBTA-Bx.xxxSE4-22	0.949 - 1.039	2.85	0.85	0.689	0.768	BTSI 022	0.866
TBTA-Bx.xxxSE4-24	1.040 - 1.122	2.85	0.85	0.748	0.827	BTSI 024	0.945

For inserts, see [page 616](#).
Operating guidelines on [page 714](#).

BTA INDEXABLE DRILL TBTA-B FOR SMALL DIAMETERS

SINGLE TUBE SYSTEM - INNER SINGLE START THREAD

Diameter
0.630 - 1.122

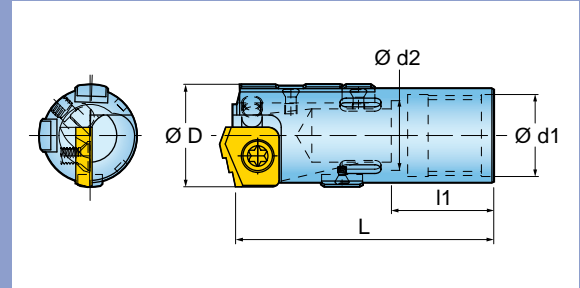

Designation	D	Dimension				Tube	
		L	l1	d1	d2	Part	Diameter
TBTA-Bx.xxxSI1-13	0.630 - 0.650	1.97	0.91	0.500	0.437	BTSE 013B	0.512
TBTA-Bx.xxxSI1-14	0.650 - 0.679	1.97	0.91	0.528	0.465	BTSE 014A	0.551
TBTA-Bx.xxxSI1-14	0.680 - 0.709	1.97	0.91	0.539	0.476	BTSE 014B	0.551
TBTA-Bx.xxxSI1-15	0.709 - 0.748	1.97	0.91	0.567	0.504	BTSE 015	0.591
TBTA-Bx.xxxSI1-16.5	0.748 - 0.787	1.97	0.91	0.606	0.543	BTSE 016.5	0.650
TBTA-Bx.xxxSI1-18	0.787 - 0.866	2.17	0.98	0.650	0.571	BTSE 018	0.709
TBTA-Bx.xxxSI1-20	0.866 - 0.984	2.17	0.98	0.748	0.630	BTSE 020	0.787
TBTA-Bx.xxxSI1-22	0.984 - 1.063	2.36	0.98	0.787	0.669	BTSE 022	0.866
TBTA-Bx.xxxSI1-24	1.063 - 1.122	2.36	0.98	0.866	0.748	BTSE 024	0.945

For inserts, see [page 616](#).
Operating guidelines on [page 714](#).

BTA INDEXABLE DRILL TBTA-B FOR SMALL DIAMETERS

ASSEMBLY OF TBTA-B SERIES

Diameter
0.630 - 1.122

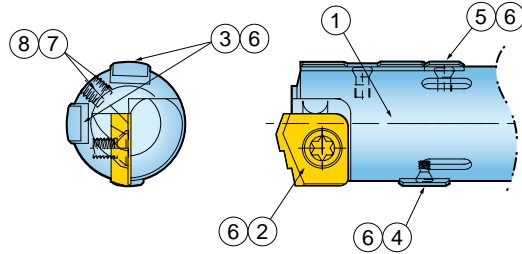

1. Head shank
2. Indexable insert
3. Guide pad
4. Sub guide
5. Guide pad protector
6. Lock screw
7. Adjusting ball
8. Adjusting screw

Parts		Diameter			
		0.630 - 0.709	0.709 - 0.827	0.827 - 0.984	0.984 - 1.122
Insert	Insert	XPMT 16002UB	XPMT 18003UB	XPMT 21003UB	XPMT 25003UB
	Screw	CSTAN05-5.5	CSTAN05-5.5	CSTAN05-5.5	CSTA4-7.5
	Wrench	T9	T9	T9	T15
	Adjust Screw	B2.5	B3	B4	B5
	Wrench	AS0003-3.5	AS0003-3.5	AS0003-3.5	AS0005-5
	Adjust Ball	H1.5	H1.5	H1.5	H2.5
Pad	Guide Pad	PAD-GC06-075	PAD-GC06-085	PAD-GC06-100	PAD-GC08-120
	Screw	CSTB2.2S	CSTB2.2S	CSTB2.2S	CSTB3S
	Wrench	T7	T7	T7	T9
	Guide Pad Protector	PAD-P06-075	PAD-P06-085	PAD-P06-100	PAD-P08-120
	Screw	CSTB2.2S	CSTB2.2S	CSTB2.2S	CSTB3S
	Wrench	T7	T7	T7	T9
	Sub Guide Pad	PAD-S06	PAD-S06	PAD-S06	PAD-S06
	Screw	CSTB2.2S	CSTB2.2S	CSTB2.2S	CSTB2.2S
Wrench	T7	T7	T7	T7	

INSERTS FOR TBTA-C INDEXABLE DRILLS

INSERTS FOR TBTA-C - COST EFFECTIVE STANDARD TOLERANCE SOLUTIONS

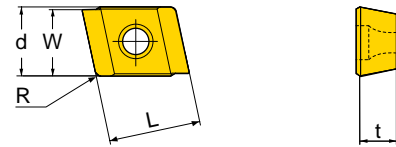

Designation	Dimension					Pocket			Grade IN2005	Screw
	d	t	L	W	R	Center	Inner	Outer		
NPMT 05504R1	0.217	0.157	0.394	0.205	0.024	○	○	○	CSTB 2.5	
NPMT 06504R1	0.256	0.157	0.394	0.244	0.024	○	○	○		
NPMT 07504R1	0.295	0.157	0.394	0.283	0.024	○	○	○		
NPMT 09504R1	0.374	0.157	0.394	0.362	0.024	○	○	○		

For use in holders TBTA-C_SE4 and TBTA-C_DE4 [pages 621](#) and [622](#).

○ = P ● = M ● = K ● = N ● = S

PAD

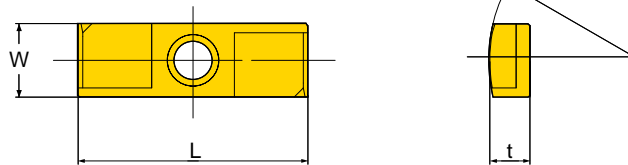

Type	Designation	Dimension				Screw
		W	t	L	r	
Guide pad	PAD-G007	0.276	0.138	0.787	0.472	CSTB 3S
	PAD-G008	0.315	0.177	0.984	0.610	CSTB 3.5S
	PAD-G010	0.394	0.177	1.181	0.787	CSTB 3.5S

For use in holders TBTA-C_SE4 and TBTA-C_DE4 [pages 621](#) and [622](#).

BTA INDEXABLE DRILLS TBTA-C

SINGLE TUBE SYSTEM - OUTER FOUR START THREAD

Diameter
0.984 - 2.094

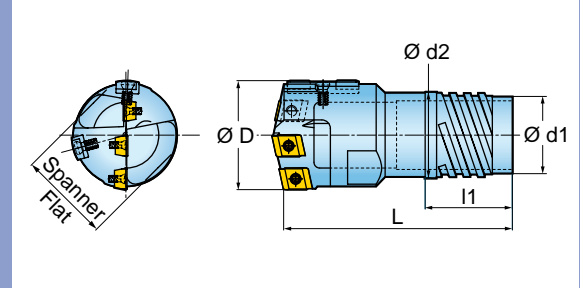

Designation	D	Dimension				Spanner Flat	Tube	
		L	l1	d1	d2		Part	Diameter
TBTA-Cx.xxxSE4-22	0.984 - 1.039	2.56	0.85	0.689	0.768	0.75	BTSI 022	0.866
TBTA-Cx.xxxSE4-24	1.040 - 1.130	2.56	0.85	0.748	0.827	0.83	BTSI 024	0.945
TBTA-Cx.xxxSE4-26	1.130 - 1.220	2.76	0.96	0.827	0.925	0.94	BTSI 026	1.024
TBTA-Cx.xxxSE4-28	1.221 - 1.311	2.76	0.96	0.906	1.004	1.02	BTSI 028	1.102
TBTA-Cx.xxxSE4-30	1.311 - 1.425	2.76	0.96	1.004	1.102	1.10	BTSI 030	1.181
TBTA-Cx.xxxSE4-33	1.426 - 1.559	2.95	1.20	1.063	1.181	1.18	BTSI 033	1.299
TBTA-Cx.xxxSE4-36	1.559 - 1.693	3.15	1.20	1.181	1.299	1.26	BTSI 036	1.417
TBTA-Cx.xxxSE4-39	1.693 - 1.850	3.54	1.20	1.299	1.417	1.42	BTSI 039	1.535
TBTA-Cx.xxxSE4-43	1.851 - 2.035	3.54	1.20	1.417	1.535	1.50	BTSI 043	1.693
TBTA-Cx.xxxSE4-47	2.036 - 2.094	3.54	1.36	1.555	1.693	1.81	BTSI 047	1.850

For inserts, see [page 620](#).
Operating guidelines on [page 714](#).

BTA INDEXABLE DRILLS TBTA-C

DOUBLE TUBE SYSTEM - OUTER FOUR START THREAD

Diameter
0.984 - 2.094

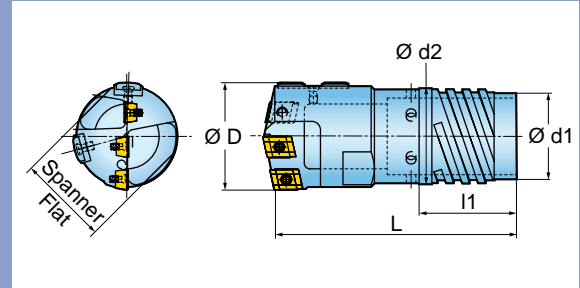

Designation	D	Dimension				Spanner Flat	Tube		
		L	l1	d1	d2		Outer tube	Inner tube	Diameter
TBTA-Cx.xxxDE4-23.5	0.984 - 1.039	2.56	0.85	0.748	0.827	0.75	BTDO 023.5	BTDI 016	0.925
TBTA-Cx.xxxDE4-26	1.040 - 1.130	2.76	0.96	0.827	0.925	0.83	BTDO 026	BTDI 018	1.024
TBTA-Cx.xxxDE4-28	1.130 - 1.220	2.76	0.96	0.906	1.004	0.94	BTDO 028	BTDI 020	1.102
TBTA-Cx.xxxDE4-30.5	1.221 - 1.311	2.76	0.96	1.004	1.122	1.02	BTDO 030.5	BTDI 022	1.201
TBTA-Cx.xxxDE4-33	1.311 - 1.425	2.95	1.20	1.063	1.181	1.10	BTDO 033	BTDI 024	1.299
TBTA-Cx.xxxDE4-35.5	1.426 - 1.512	2.95	1.20	1.181	1.299	1.18	BTDO 035.5	BTDI 026	1.398
TBTA-Cx.xxxDE4-35.5	1.512 - 1.559	2.95	1.20	1.181	1.299	1.18	BTDO 035.5	BTDI 026	1.398
TBTA-Cx.xxxDE4-39	1.559 - 1.646	3.15	1.20	1.299	1.417	1.26	BTDO 039	BTDI 029	1.535
TBTA-Cx.xxxDE4-39	1.646 - 1.693	3.15	1.20	1.299	1.417	1.26	BTDO 039	BTDI 029	1.535
TBTA-Cx.xxxDE4-42.5	1.693 - 1.795	3.54	1.20	1.417	1.535	1.42	BTDO 042.5	BTDI 032	1.673
TBTA-Cx.xxxDE4-42.5	1.796 - 1.850	3.54	1.20	1.417	1.535	1.42	BTDO 042.5	BTDI 032	1.673
TBTA-Cx.xxxDE4-46.5	1.851 - 2.035	3.54	1.36	1.555	1.693	1.50	BTDO 046.5	BTDI 035	1.831
TBTA-Cx.xxxDE4-51	2.036 - 2.094	3.54	1.36	1.713	1.850	1.50	BTDO 051	BTDI 039	2.008

For inserts, see [page 620](#).
Operating guidelines on [page 714](#).

BTA INDEXABLE DRILLS TBTA-C

ASSEMBLY OF TBTA-C SERIES

Diameter
0.984 - 2.094

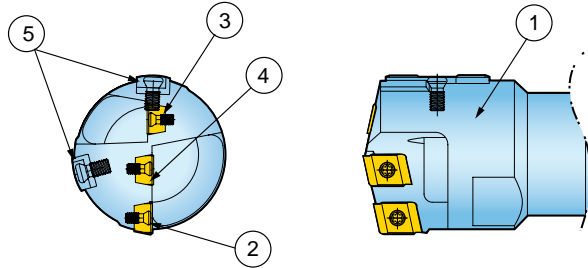

1. Head shank
2. Outer insert
3. Inner insert
4. Center insert
5. Guide pad

Parts		Diameter						
		0.984 - 1.039	1.040 - 1.130	1.130 - 1.220	1.221 - 1.311	1.311 - 1.425	1.426 - 1.512	1.512 - 1.559
Inserts	Outer	NPMT 05504R1	NPMT 05504R1	NPMT 06504R1	NPMT 06504R1	NPMT 06504R1	NPMT 07504R1	NPMT 07504R1
	Screw	CSTB2.5	CSTB2.5	CSTB2.5	CSTB2.5	CSTB2.5	CSTB2.5	CSTB2.5
	Wrench	T8	T8	T8	T8	T8	T8	T8
	Inner	NPMT 05504R1	NPMT 05504R1	NPMT 05504R1	NPMT 05504R1	NPMT 06504R1	NPMT 06504R1	NPMT 06504R1
	Screw	CSTB2.5	CSTB2.5	CSTB2.5	CSTB2.5	CSTB2.5	CSTB2.5	CSTB2.5
	Wrench	T8	T8	T8	T8	T8	T8	T8
	Center	NPMT 05504R1	NPMT 05504R1	NPMT 05504R1	NPMT 06504R1	NPMT 06504R1	NPMT 06504R1	NPMT 07504R1
	Screw	CSTB2.5	CSTB2.5	CSTB2.5	CSTB2.5	CSTB2.5	CSTB2.5	CSTB2.5
	Wrench	T8	T8	T8	T8	T8	T8	T8
Pads	Guide Pad	PAD-G007	PAD-G007	PAD-G007	PAD-G007	PAD-G007	PAD-G007	PAD-G008
	Screw	CSTB3S	CSTB3S	CSTB3S	CSTB3S	CSTB3S	CSTB3S	CSTB3.5
	Wrench	T9	T9	T9	T9	T9	T9	T9

Parts		Diameter					
		1.559 - 1.646	1.646 - 1.693	1.693 - 1.795	1.796 - 1.850	1.851 - 2.035	2.036 - 2.094
Inserts	Outer	NPMT 07504R1	NPMT 09504R1	NPMT 09504R1	NPMT 09504R1	NPMT 09504R1	NPMT 09504R1
	Screw	CSTB2.5	CSTB2.5	CSTB2.5	CSTB2.5	CSTB2.5	CSTB2.5
	Wrench	T8	T8	T8	T8	T8	T8
	Inner	NPMT 07504R1	NPMT 07504R1	NPMT 07504R1	NPMT 07504R1	NPMT 09504R1	NPMT 09504R1
	Screw	CSTB2.5	CSTB2.5	CSTB2.5	CSTB2.5	CSTB2.5	CSTB2.5
	Wrench	T8	T8	T8	T8	T8	T8
	Center	NPMT 07504R1	NPMT 07504R1	NPMT 09504R1	NPMT 09504R1	NPMT 09504R1	NPMT 09504R1
	Screw	CSTB2.5	CSTB2.5	CSTB2.5	CSTB2.5	CSTB2.5	CSTB2.5
	Wrench	T8	T8	T8	T8	T8	T8
Pads	Guide Pad	PAD-G008	PAD-G008	PAD-G008	PAD-G010	PAD-G010	PAD-G010
	Screw	CSTB3.5	CSTB3.5	CSTB3.5	CSTB3.5	CSTB3.5	CSTB3.5
	Wrench	T9	T9	T9	T9	T9	T9

INSERTS FOR TBTA-D

INSERTS FOR TBTA-D - FOR HIGH PRODUCTIVITY

NPMT-R2

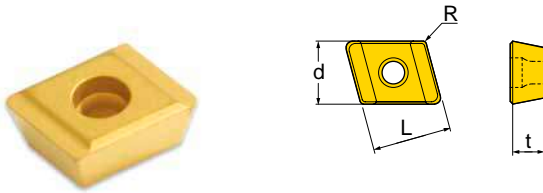

NPMT-L2

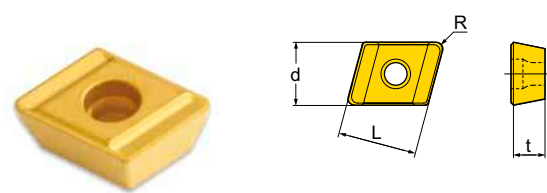

Designation	Dimension				Pocket			Grade IN2005	Screw
	d	t	L	R	Center	Inner	Outer		
NPMT 06504L2	0.256	0.157	0.394	0.031	○			CSTB 2.5	
NPMT 0804L2	0.315	0.157	0.394	0.031	○				
NPMT 09504L2	0.374	0.157	0.394	0.031	○				
NPMT 12504L2	0.492	0.157	0.394	0.031	○				
NPMT 06504R2	0.256	0.157	0.394	0.016		○	○	CSTB 2.5	
NPMT 0804R2	0.315	0.157	0.394	0.016		○	○		
NPMT 09504R2	0.374	0.157	0.394	0.016		○	○		
NPMT 12504R2	0.492	0.157	0.394	0.016		○	○		

For use in holders TBTA-D_SE4 and TBTA-D_DE4, pages 625 and 626.

○ = P ● = M ● = K ● = N ● = S

PAD

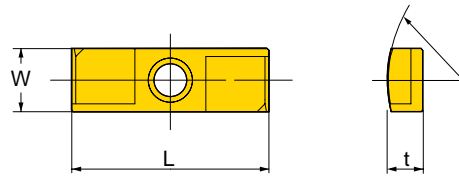

Type	Designation	Dimension				Screw
		W	t	L	r	
Guide pad	PAD-G007	0.276	0.138	0.787	0.472	CSTB 3S
	PAD-G008	0.315	0.177	0.984	0.610	CSTB 3.5S
	PAD-G010	0.394	0.177	1.181	0.787	CSTB 3.5S
	PAD-G012	0.472	0.217	1.378	0.984	CSTB 3.5S

For use in holders TBTA-D_SE4 and TBTA-D_DE4, pages 625 and 626.

BTA INDEXABLE DRILLS TBTA-D

SINGLE TUBE SYSTEM - OUTER FOUR START THREAD

Diameter
1.181 - 2.559

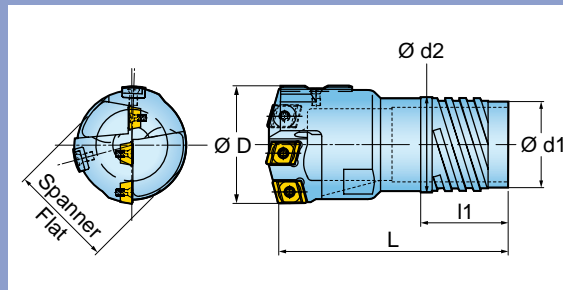

Designation	D	L	Dimension			Spanner Flat	Tube	
			l1	d1	d2		Part	Diameter
TBTA-Dx.xxxSE4-26	1.181 - 1.220	2.76	0.96	0.827	0.925	0.75	BTSI 026	1.024
TBTA-Dx.xxxSE4-28	1.221 - 1.311	2.76	0.96	0.906	1.004	0.83	BTSI 028	1.102
TBTA-Dx.xxxSE4-30	1.311 - 1.425	2.76	0.96	1.004	1.102	0.94	BTSI 030	1.181
TBTA-Dx.xxxSE4-33	1.426 - 1.559	2.95	1.20	1.063	1.181	1.02	BTSI 033	1.299
TBTA-Dx.xxxSE4-36	1.559 - 1.693	3.15	1.20	1.181	1.299	1.10	BTSI 036	1.417
TBTA-Dx.xxxSE4-39	1.693 - 1.850	3.54	1.20	1.299	1.417	1.18	BTSI 039	1.535
TBTA-Dx.xxxSE4-43	1.851 - 2.035	3.54	1.20	1.417	1.535	1.26	BTSI 043	1.693
TBTA-Dx.xxxSE4-47	2.036 - 2.213	3.54	1.36	1.555	1.693	1.42	BTSI 047	1.850
TBTA-Dx.xxxSE4-51	2.213 - 2.386	3.54	1.36	1.713	1.870	1.50	BTSI 051	2.008
TBTA-Dx.xxxSE4-56	2.386 - 2.559	3.54	1.36	1.870	2.008	1.81	BTSI 056	2.205

For inserts, see [page 624](#).
Operating guidelines on [page 714](#).

BTA INDEXABLE DRILLS TBTA-D

SINGLE TUBE SYSTEM - OUTER FOUR START THREAD

Diameter
1.181 - 2.559

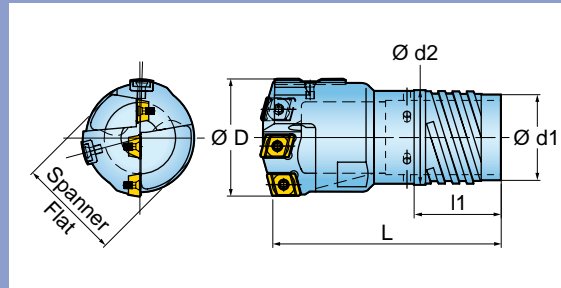

Designation	D	Dimension				Spanner Flat	Tube		
		L	l1	d1	d2		Outer tube	Inner tube	Diameter
TBTA-Dx.xxxDE4-28	1.181 - 1.220	2.76	0.96	0.906	1.004	1.02	BTDO 028	BTDI 020	1.102
TBTA-Dx.xxxDE4-30.5	1.221 - 1.311	2.76	0.96	1.004	1.102	1.10	BTDO 030.5	BTDI 022	1.201
TBTA-Dx.xxxDE4-33	1.311 - 1.425	2.95	1.20	1.063	1.181	1.18	BTDO 033	BTDI 024	1.299
TBTA-Dx.xxxDE4-35.5	1.426 - 1.559	3.15	1.20	1.181	1.299	1.26	BTDO 035.5	BTDI 026	1.398
TBTA-Dx.xxxDE4-39	1.559 - 1.693	3.15	1.20	1.299	1.417	1.42	BTDO 039	BTDI 029	1.535
TBTA-Dx.xxxDE4-42.5	1.693 - 1.850	3.54	1.20	1.417	1.535	1.50	BTDO 042.5	BTDI 032	1.673
TBTA-Dx.xxxDE4-46.5	1.851 - 2.035	3.54	1.36	1.555	1.693	1.57	BTDO 046.5	BTDI 035	1.831
TBTA-Dx.xxxDE4-51	2.036 - 2.213	3.54	1.36	1.713	1.870	1.97	BTDO 051	BTDI 039	2.008
TBTA-Dx.xxxDE4-55.5	2.213 - 2.559	3.54	1.36	1.870	2.008	1.97	BTDO 055.5	BTDI 043	2.185

For inserts, see [page 624](#).
Operating guidelines on [page 714](#).

BTA INDEXABLE DRILLS TBTA-D

ASSEMBLY OF TBTA-D SERIES

Diameter
1.181 - 2.559

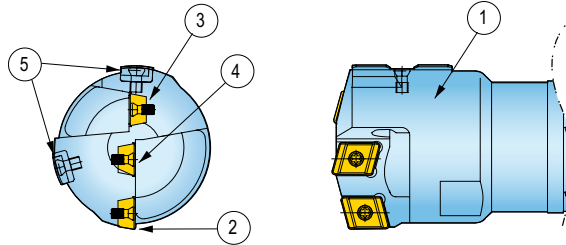

1. Head shank
2. Outer insert
3. Inner insert
4. Center insert
5. Guide pad

Parts		Diameter				
		1.181 - 1.299	1.300 - 1.417	1.418 - 1.535	1.536 - 1.654	1.654 - 1.772
Inserts	Outer	NPMT 06504R2	NPMT 06504R2	NPMT 0804R2	NPMT 0804R2	NPMT 0804R2
	Screw	CSTB 2.5	CSTB 2.5	CSTB 2.5	CSTB 2.5	CSTB 2.5
	Wrench	T8	T8	T8	T8	T8
	Inner	NPMT 06504R2	NPMT 06504R2	NPMT 06504R2	NPMT 0804R2	NPMT 0804R2
	Screw	CSTB 2.5	CSTB 2.5	CSTB 2.5	CSTB 2.5	CSTB 2.5
	Wrench	T8	T8	T8	T8	T8
	Center	NPMT 06504L2	NPMT 0804L2	NPMT 0804L2	NPMT 0804L2	NPMT 09504L2
	Screw	CSTB 2.5	CSTB 2.5	CSTB 2.5	CSTB 2.5	CSTB 2.5
	Wrench	T8	T8	T8	T8	T8
Pads	Guide Pad	PAD-G007	PAD-G007	PAD-G007	PAD-G008	PAD-G008
	Screw	CSTB 3S	CSTB 3S	CSTB 3S	CSTB 3.5	CSTB 3.5
	Wrench	T9	T9	T9	T9	T9

Parts		Diameter				
		1.772 - 1.890	1.890 - 2.008	2.008 - 2.244	2.244 - 2.480	2.481 - 2.559
Inserts	Outer	NPMT 09504R2	NPMT 09504R2	NPMT 09504R2	NPMT 12504R2	NPMT 12504R2
	Screw	CSTB2.5	CSTB2.5	CSTB2.5	CSTB2.5	CSTB2.5
	Wrench	T8	T8	T8	T8	T8
	Inner	NPMT 0804R2	NPMT 09504R2	NPMT 09504R2	NPMT 09504R2	NPMT 12504R2
	Screw	CSTB2.5	CSTB2.5	CSTB2.5	CSTB2.5	CSTB2.5
	Wrench	T8	T8	T8	T8	T8
	Center	NPMT 09504L2	NPMT 09504L2	NPMT 12504L2	NPMT 12504L2	NPMT 12504L2
	Screw	CSTB2.5	CSTB2.5	CSTB2.5	CSTB2.5	CSTB2.5
	Wrench	T8	T8	T8	T8	T8
Pads	Guide Pad	PAD-G010	PAD-G010	PAD-G010	PAD-G012	PAD-G012
	Screw	CSTB3.5	CSTB3.5	CSTB3.5	CSTB3.5	CSTB3.5
	Wrench	T9	T9	T9	T9	T9

INSERTS FOR TBTA-L FOR LARGE DIAMETERS

INSERTS FOR TBTA-L

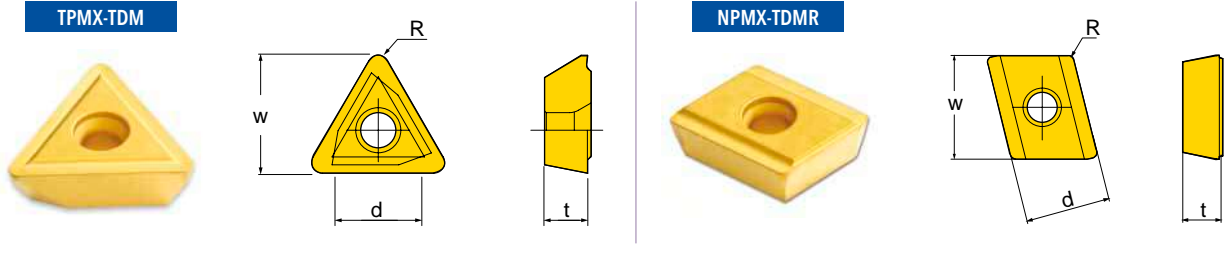

Designation	Dimension				Pocket			Grade IN2005	Screw
	d	W	R	t	Center	Inner	Outer		
TPMX 16-TDM	0.375	0.515	0.047	0.187	○	○	○	⊕	CSTB3.5D
TPMX 22-TDM	0.500	0.703	0.047	0.250	○	○	○	⊕	CSTB4M
NPMT 13-TDMR	0.433	0.531	0.031	0.187			○*	⊕	CSTB3.5D
NPMT 19-TDMR	0.472	0.768	0.024	0.250			○*	⊕	CSTB4M

* NPMX type insert is available for outer pocket on request.
For use in holder TBTA-L_SE4, page 630.

○ = P ⊕ = M ⊖ = K ⊙ = N ⊗ = S

PAD

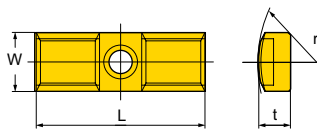

Guide pad

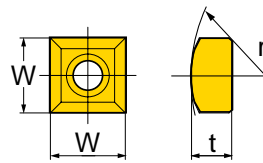

Guide pad protector

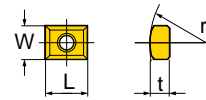

Sub pad

Type	Designation	Dimension				Screw
		W	t	L	r	
Guide pad	PAD-GC14	0.551	0.295	1.575	0.984	CSTA5S
	PAD-GC18	0.709	0.354	1.575	1.181	LS1206S
	PAD-GC22	0.866	0.591	1.969	2.953	LS1206
Guide pad protector	PAD-P14	0.551	0.295	0.551	0.984	CSTA5S
	PAD-P18	0.709	0.354	0.709	1.181	LS1206S
	PAD-P22	0.866	0.591	0.866	2.953	LS1206
Sub pad	PAD-S10	0.394	0.197	0.394	1.142	CSTB3S
	PAD-S14	0.551	0.276	0.787	1.772	CSTB5S

For use in holder TBTA-L_SE4, page 630.

CARTRIDGE FOR TBTA-L FOR LARGE DIAMETERS

CARTRIDGE FOR TBTA-L

Outer

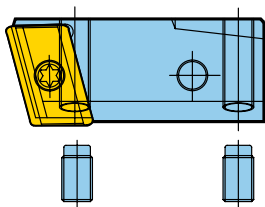

Inner

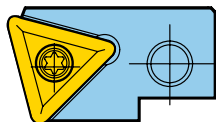

Center

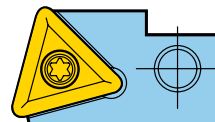

	Designation	Adjusting Screw	Wrench	Lock Screw	Wrench	Insert
Outer cartridge	PERC310-13QRA	AS0006-10	H3	LS1805RH	H4	NPMX13-TDMR
	PERC310-19QRA	AS0006-15	H3	LS1806RH	H4	NPMX19-TDMR
Inner cartridge	CENC310-16TRB	-	-	LS1206	H3	TPMX16-TDM
	CENC310-22TRB	-	-	LS1206	H3	TPMX22-TDM
Center cartridge	CENC310-16TLB	-	-	LS1206	H3	TPMX16-TDM
	CENC310-12TLB	-	-	LS1206	H3	TPMX22-TDM

For use in holder TBTA-L_SE4, [page 630](#).

BTA INDEXABLE DRILLS TBTA-L FOR LARGE DIAMETERS

SINGLE TUBE SYSTEM - OUTER FOUR START THREAD

Diameter
2.441 - 7.244

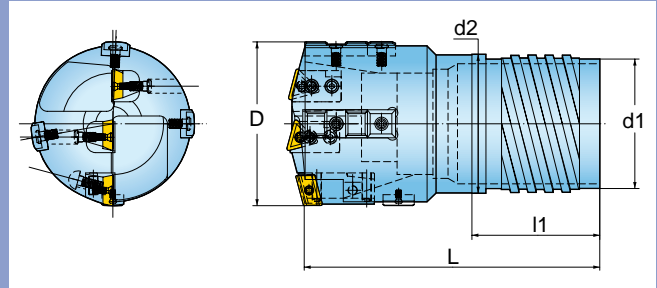

Designation	D	L	Dimension			Part	Tube Diameter
			l1	d1	d2		
TBTA-Lx.xxxSE4-56A	2.441 - 2.559	4.72	1.36	1.870	2.008	BTSI 056A	2.205
TBTA-Lx.xxxSE4-56B	2.559 - 2.637	6.30	2.44	1.850	2.047	BTSI 056B	2.205
TBTA-Lx.xxxSE4-62	2.638 - 2.874	6.30	2.44	2.087	2.283	BTSI 062	2.441
TBTA-Lx.xxxSE4-68	2.874 - 3.149	6.30	2.44	2.283	2.480	BTSI 068	2.677
TBTA-Lx.xxxSE4-75	3.150 - 3.425	7.48	3.23	2.520	2.756	BTSI 075	2.953
TBTA-Lx.xxxSE4-82	3.425 - 3.937	7.48	3.23	2.795	3.031	BTSI 082	3.228
TBTA-Lx.xxxSE4-94	3.937 - 4.409	7.48	3.23	3.268	3.504	BTSI 094	3.701
TBTA-Lx.xxxSE4-106	4.409 - 4.881	8.27	4.02	3.740	3.976	BTSI 106	4.173
TBTA-Lx.xxxSE4-118	4.882 - 5.354	8.27	4.02	4.213	4.449	BTSI 118	4.646
TBTA-Lx.xxxSE4-130	5.354 - 5.826	8.66	4.02	4.685	4.921	BTSI 130	5.118
TBTA-Lx.xxxSE4-142	5.827 - 6.299	8.66	4.80	5.157	5.394	BTSI 142	5.591
TBTA-Lx.xxxSE4-154	6.299 - 6.771	8.66	4.80	5.630	5.630	BTSI 154	6.063
TBTA-Lx.xxxSE4-166	6.772 - 7.244	8.66	4.80	6.102	6.339	BTSI 166	6.535

For inserts, see [page 628](#).
Operating guidelines on [page 714](#).

BTA INDEXABLE DRILL TBTA-L SERIES

ASSEMBLY OF TBTA-L SERIES

Diameter
2.441 - 5.118

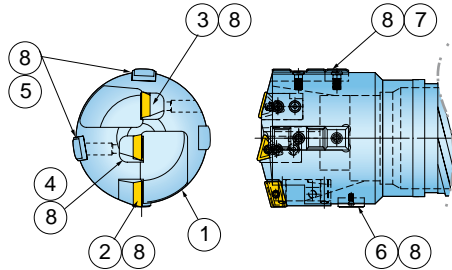

1. Head shank
2. Outer cartridge
3. Inner cartridge
4. Center cartridge
5. Guide pad
6. Sub guide pad
7. Guide pad protector
8. Lock screw

Parts		Diameter							
		2.441 - 2.913	2.913 - 3.267	3.268 - 3.700	3.701 - 3.937	3.937 - 4.173	4.173 - 4.724	4.724 - 5.118	
Cartridge	Outer	PERC310-13QRA	PERC310-19QRA	PERC310-19QRA	PERC310-19QRA	PERC310-19QRA	PERC310-13QRA	PERC310-19QRA	
	Adjust Screw	AS0006-10	AS0006-15	AS0006-15	AS0006-15	AS0006-15	AS0006-10	AS0006-15	
	Wrench	H3	H3	H3	H3	H3	H3	H3	
	Screw	LS1805RH	LS1806RH	LS1806RH	LS1806RH	LS1806RH	LS1805RH	LS1806RH	
	Wrench	H4	H4	H4	H4	H4	H4	H4	
	Inner	CENC310-16TRB	CENC310-16TRB	CENC310-16TRB	CENC310-22TRB	CENC310-22TRB	CENC310-16TRB	CENC310-16TRB	
	Screw	LS1206	LS1206	LS1206	LS1206	LS1206	LS1206	LS1206	
	Wrench	H3	H3	H3	H3	H3	H3	H3	
	Center	CENC310-16TLB	CENC310-16TLB	CENC310-22TLB	CENC310-22TLB	CENC310-22TLB	CENC310-16TLB	CENC310-16TLB	
	Screw	LS1206	LS1206	LS1206	LS1206	LS1206	LS1206	LS1206	
	Wrench	H3	H3	H3	H3	H3	H3	H3	
	Insert	Outer	NPMT 13-TDMR	NPMT 19-TDMR	NPMT 19-TDMR	NPMT 19-TDMR	NPMT 19-TDMR	NPMT 13-TDMR	NPMT 19-TDMR
Screw		CSTB3.5D	CSTB4M	CSTB4M	CSTB4M	CSTB4M	CSTB3.5D	CSTB4M	
Wrench		T9	T15	T15	T15	T15	T9	T15	
Inner		TPMX 16-TDM	TPMX 16-TDM	TPMX 16-TDM	TPMX 22-TDM	TPMX 22-TDM	TPMX 16-TDM	TPMX 16-TDM	
Screw		CSTB3.5D	CSTB3.5D	CSTB3.5D	CSTB4M	CSTB4M	CSTB3.5D	CSTB3.5D	
Wrench		T9	T9	T9	T15	T15	T9	T9	
Center		TPMX 16-TDM	TPMX 16-TDM	TPMX 22-TDM	TPMX 22-TDM	TPMX 22-TDM	TPMX 16-TDM	TPMX 16-TDM	
Screw		CSTB3.5D	CSTB3.5D	CSTB4M	CSTB4M	CSTB4M	CSTB3.5D	CSTB3.5D	
Wrench		T9	T9	T15	T15	T15	T9	T9	
Pad		Guide Pad	PAD-GC14	PAD-GC14	PAD-GC14	PAD-GC18	PAD-GC18	PAD-GC18	PAD-GC18
		Screw	CSTA5S	CSTA5S	CSTA5S	LS1206S	LS1206S	LS1206S	LS1206S
		Wrench	T15	T15	T15	H3	H3	H3	H3
	Guide Pad Protector	PAD-P14	PAD-P14	PAD-P14	PAD-P18	PAD-P18	PAD-P18	PAD-P18	
	Screw	CSTA5S	CSTA5S	CSTA5S	LS1206S	LS1206S	LS1206S	LS1206S	
	Wrench	T15	T15	T15	H3	H3	H3	H3	
	Sub Guide Pad	PAD-S10	PAD-S10	PAD-S10	PAD-S14	PAD-S14	PAD-S14	PAD-S14	
	Screw	CSTB3S	CSTB3S	CSTB3S	CSTB5S	CSTB5S	CSTB5S	CSTB5S	
	Wrench	T9	T9	T9	T15	T15	T15	T15	

BTA INDEXABLE DRILLS TBTA-L SERIES

ASSEMBLY OF TBTA-L SERIES

Diameter
5.118 - 7.401

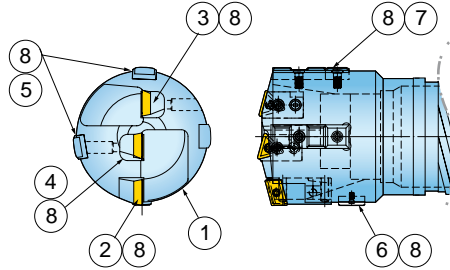

1. Head shank
2. Outer cartridge
3. Inner cartridge
4. Center cartridge
5. Guide pad
6. Sub guide pad
7. Guide pad protector
8. Lock screw

Parts		Diameter					
		5.118 - 5.551	5.551 - 5.944	5.945 - 6.378	6.378 - 6.811	6.811 - 7.007	7.008 - 7.401
Cartridge	Outer	PERC310-19QRA	PERC310-19QRA	PERC310-19QRA	PERC310-190QRA	PERC310-13QRA	PERC310-13QRA
	Adjust Screw	AS0006-15	AS0006-15	AS0006-15	AS0006-15	AS0006-10	AS0006-10
	Wrench	H3	H3	H3	H3	H3	H3
	Screw	LS1806RH	LS1806RH	LS1806RH	LS1806RH	LS1805RH	LS1805RH
	Wrench	H4	H4	H4	H4	H4	H4
	Inner	CENC310-16TRB	CENC310-16TRB CENC310-22TRB	CENC310-16TRB CENC310-22TRB	CENC310-22TRB	CENC310-16TRB	CENC310-16TRB CENC310-22TRB
	Screw	LS1206	LS1206	LS1206	LS1206	LS1206	LS1206
	Wrench	H3	H3	H3	H3	H3	H3
	Center	CENC310-22TLB	CENC310-22TLB	CENC310-22TLB	CENC310-22TLB	CENC310-22TLB	CENC310-22TLB
	Screw	LS1206	LS1206	LS1206	LS1206	LS1206	LS1206
Wrench	H3	H3	H3	H3	H3	H3	
Insert	Outer	NPMT 19-TDMR	NPMT 19-TDMR	NPMT 19-TDMR	NPMT 19-TDMR	NPMT 13-TDMR	NPMT 13-TDMR
	Screw	CSTB4M	CSTB4M	CSTB4M	CSTB4M	CSTB3.5D	CSTB3.5D
	Wrench	T15	T15	T15	T15	T9	T9
	Inner	TPMX 16-TDM	TPMX 16-TDM	TPMX 16-TDM	TPMX 22-TDM	TPMX 16-TDM	TPMX 16-TDM
	Screw	CSTB3.5D	CSTB3.5D	CSTB3.5D	CSTB4M	CSTB3.5D	CSTB3.5D
	Wrench	T9	T9	T9	T15	T9	T9
	Center	TPMX 22-TDM	TPMX 22-TDM	TPMX 22-TDM	TPMX 22-TDM	TPMX 22-TDM	TPMX 22-TDM
	Screw	CSTB4M	CSTB4M	CSTB4M	CSTB4M	CSTB4M	CSTB4M
Wrench	T15	T15	T15	T15	T15	T15	
Pad	Guide Pad	PAD-GC18	PAD-GC18	PAD-GC18	PAD-GC18	PAD-GC22	PAD-GC22
	Screw	LS1206S	LS1206S	LS1206S	LS1206S	LS1206	LS1206
	Wrench	H3	H3	H3	H3	H3	H3
	Guide Pad Protector	PAD-P18	PAD-P18	PAD-P18	PAD-P18	PAD-P22	PAD-P22
	Screw	LS1206S	LS1206S	LS1206S	LS1206S	LS1206	LS1206
	Wrench	H3	H3	H3	H3	H3	H3
	Sub Guide Pad	PAD-S14	PAD-S14	PAD-S14	PAD-S14	PAD-S14	PAD-S14
	Screw	CSTA5S	CSTA5S	CSTA5S	CSTA5S	CSTA5S	CSTA5S
Wrench	T15	T15	T15	T15	T15	T15	

BTA DRILLS BRAZED - BTA-SERIES

SINGLE TUBE SYSTEM - OUTER FOUR START THREAD

Diameter
0.496 - 1.559

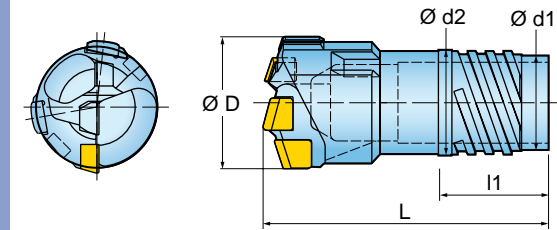

Designation	Diameter	Dimension				Tube		Grade		
		L	l1	d1	d2	Part	Diameter	TB103	TB203	TB253
BTA x.xxx SE2-11	0.496 - 0.516	1.69	0.93	0.323	0.378	BTSI011	0.433	○	○	○
BTA x.xxx SE2-11	0.516 - 0.535	1.69	0.93	0.323	0.378	BTSI011	0.433	○	○	○
BTA x.xxx SE2-12	0.536 - 0.555	1.69	0.93	0.362	0.417	BTSI012	0.472	○	○	○
BTA x.xxx SE2-12	0.556 - 0.575	1.69	0.93	0.362	0.417	BTSI012	0.472	○	○	○
BTA x.xxx SE2-13	0.575 - 0.594	1.69	0.93	0.402	0.457	BTSI013	0.512	○	○	○
BTA x.xxx SE2-13	0.595 - 0.614	1.69	0.93	0.402	0.457	BTSI013	0.512	○	○	○
BTA x.xxx SE4-14	0.614 - 0.638	1.69	0.79	0.425	0.496	BTSI014	0.551	○	○	○
BTA x.xxx SE4-14	0.638 - 0.657	1.69	0.79	0.425	0.496	BTSI014	0.551	○	○	○
BTA x.xxx SE4-15	0.658 - 0.677	1.69	0.79	0.465	0.535	BTSI015	0.591	○	○	○
BTA x.xxx SE4-15	0.678 - 0.697	1.69	0.79	0.465	0.535	BTSI015	0.591	○	○	○
BTA x.xxx SE4-16	0.697 - 0.724	1.85	0.85	0.492	0.571	BTSI016	0.630	○	○	○
BTA x.xxx SE4-16	0.725 - 0.744	1.85	0.85	0.492	0.571	BTSI016	0.630	○	○	○
BTA x.xxx SE4-17	0.744 - 0.756	1.85	0.85	0.531	0.610	BTSI017	0.669	○	○	○
BTA x.xxx SE4-17	0.756 - 0.787	1.85	0.85	0.531	0.610	BTSI017	0.669	○	○	○
BTA x.xxx SE4-18	0.788 - 0.823	2.07	0.85	0.551	0.630	BTSI018	0.709	○	○	○
BTA x.xxx SE4-18	0.823 - 0.858	2.07	0.85	0.551	0.630	BTSI018	0.709	○	○	○
BTA x.xxx SE4-20	0.859 - 0.902	2.20	0.85	0.630	0.709	BTSI020	0.787	○	○	○
BTA x.xxx SE4-20	0.902 - 0.949	2.20	0.85	0.630	0.709	BTSI020	0.787	○	○	○
BTA x.xxx SE4-22	0.949 - 0.992	2.26	0.85	0.689	0.768	BTSI022	0.866	○	○	○
BTA x.xxx SE4-22	0.993 - 1.039	2.26	0.85	0.689	0.768	BTSI022	0.866	○	○	○
BTA x.xxx SE4-24	1.040 - 1.083	2.26	0.85	0.748	0.827	BTSI024	0.945	○	○	○
BTA x.xxx SE4-24	1.083 - 1.130	2.26	0.85	0.748	0.827	BTSI024	0.945	○	○	○
BTA x.xxx SE4-26	1.130 - 1.173	2.50	0.96	0.827	0.925	BTSI026	1.024	○	○	○
BTA x.xxx SE4-26	1.174 - 1.220	2.50	0.96	0.827	0.925	BTSI026	1.024	○	○	○
BTA x.xxx SE4-28	1.221 - 1.264	2.50	0.96	0.906	1.004	BTSI028	1.102	○	○	○
BTA x.xxx SE4-28	1.264 - 1.311	2.50	0.96	0.906	1.004	BTSI028	1.102	○	○	○
BTA x.xxx SE4-30	1.311 - 1.370	2.50	0.96	1.004	1.102	BTSI030	1.181	○	○	○
BTA x.xxx SE4-30	1.370 - 1.425	2.50	0.96	1.004	1.102	BTSI030	1.181	○	○	○
BTA x.xxx SE4-33	1.426 - 1.469	2.89	1.20	1.063	1.181	BTSI033	1.299	○	○	○
BTA x.xxx SE4-33	1.469 - 1.512	2.89	1.20	1.063	1.181	BTSI033	1.299	○	○	○
BTA x.xxx SE4-33	1.512 - 1.559	2.89	1.20	1.063	1.181	BTSI033	1.299	○	○	○

Operating guidelines on [page 714](#).

○ = on request

BTA DRILL BRAZED - BTA-SERIES

SINGLE TUBE SYSTEM - OUTER FOUR START THREAD

Diameter
1.559 - 2.559

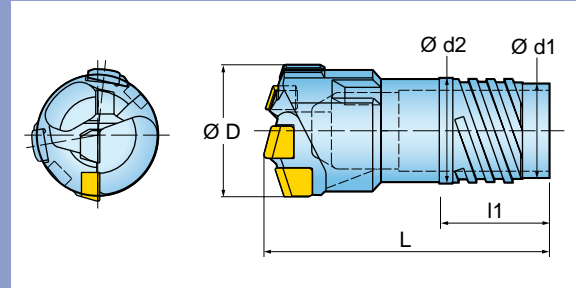

Designation	D	Dimension				Tube		Grade		
		L	l1	d1	d2	Part	Diameter	TB103	TB203	TB253
BTA x.xxx SE4-36	1.559 - 1.598	2.89	1.20	1.181	1.299	BTSI036	1.417	○	○	○
BTA x.xxx SE4-36	1.599 - 1.646	2.89	1.20	1.181	1.299	BTSI036	1.417	○	○	○
BTA x.xxx SE4-36	1.646 - 1.693	2.89	1.20	1.181	1.299	BTSI036	1.417	○	○	○
BTA x.xxx SE4-39	1.693 - 1.744	2.95	1.20	1.299	1.417	BTSI039	1.535	○	○	○
BTA x.xxx SE4-39	1.744 - 1.795	2.95	1.20	1.299	1.417	BTSI039	1.535	○	○	○
BTA x.xxx SE4-39	1.796 - 1.850	2.95	1.20	1.299	1.417	BTSI039	1.535	○	○	○
BTA x.xxx SE4-43	1.851 - 1.909	2.95	1.20	1.417	1.535	BTSI043	1.693	○	○	○
BTA x.xxx SE4-43	1.910 - 1.972	2.95	1.20	1.417	1.535	BTSI043	1.693	○	○	○
BTA x.xxx SE4-43	1.973 - 2.035	2.95	1.20	1.417	1.535	BTSI043	1.693	○	○	○
BTA x.xxx SE4-47	2.036 - 2.094	3.23	1.36	1.555	1.693	BTSI047	1.850	○	○	○
BTA x.xxx SE4-47	2.095 - 2.154	3.23	1.36	1.555	1.693	BTSI047	1.850	○	○	○
BTA x.xxx SE4-47	2.154 - 2.213	3.23	1.36	1.555	1.693	BTSI047	1.850	○	○	○
BTA x.xxx SE4-51	2.213 - 2.299	3.31	1.36	1.713	1.850	BTSI051	2.008	○	○	○
BTA x.xxx SE4-51	2.300 - 2.386	3.31	1.36	1.713	1.850	BTSI051	2.008	○	○	○
BTA x.xxx SE4-51	2.386 - 2.472	3.31	1.36	1.713	1.850	BTSI051	2.008	○	○	○
BTA x.xxx SE4-51	2.473 - 2.559	3.31	1.36	1.713	1.850	BTSI051	2.008	○	○	○
BTA x.xxx SE4-56	2.386 - 2.472	3.31	1.36	1.870	2.008	BTSI056	2.205	○	○	○
BTA x.xxx SE4-56	2.473 - 2.559	3.31	1.36	1.870	2.008	BTSI056	2.205	○	○	○

Operating guidelines on [page 714](#).

○ = on request

BTA DRILL BRAZED - BTA-SERIES

DOUBLE TUBE SYSTEM - OUTER FOUR START THREAD

Diameter
0.725 - 1.559

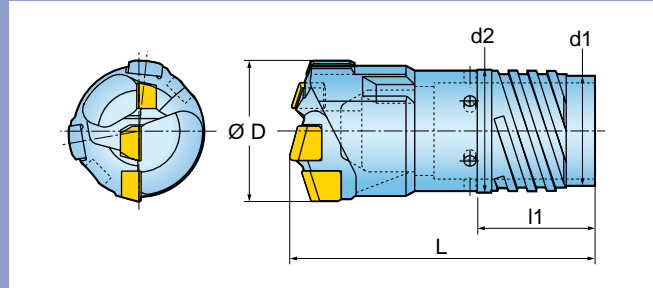

Designation	D	Dimension				Tube			Grade		
		L	l1	d1	d2	Outer tube	Inner tube	Diameter	TB103	TB203	TB253
BTA x.xxx DE4-18	0.725 - 0.756	1.97	0.85	0.551	0.630	BTDO018	BTDI012	0.709	○	○	○
BTA x.xxx DE4-18	0.756 - 0.787	1.97	0.85	0.551	0.630	BTDO018	BTDI012	0.709	○	○	○
BTA x.xxx DE4-19.5	0.788 - 0.823	2.20	0.85	0.630	0.709	BTDO019.5	BTDI014	0.768	○	○	○
BTA x.xxx DE4-19.5	0.823 - 0.858	2.20	0.85	0.630	0.709	BTDO019.5	BTDI014	0.768	○	○	○
BTA x.xxx DE4-21.5	0.859 - 0.902	2.20	0.85	0.689	0.768	BTDO021.5	BTDI015	0.846	○	○	○
BTA x.xxx DE4-21.5	0.902 - 0.949	2.20	0.85	0.689	0.768	BTDO021.5	BTDI015	0.846	○	○	○
BTA x.xxx DE4-23.5	0.949 - 0.992	2.26	0.85	0.748	0.827	BTDO023.5	BTDI016	0.925	○	○	○
BTA x.xxx DE4-23.5	0.993 - 1.039	2.26	0.85	0.748	0.827	BTDO023.5	BTDI016	0.925	○	○	○
BTA x.xxx DE4-26	1.040 - 1.083	2.38	0.96	0.827	0.925	BTDO026	BTDI018	1.024	○	○	○
BTA x.xxx DE4-26	1.083 - 1.130	2.38	0.96	0.827	0.925	BTDO026	BTDI018	1.024	○	○	○
BTA x.xxx DE4-28	1.130 - 1.173	2.50	0.96	0.906	1.004	BTDO028	BTDI020	1.102	○	○	○
BTA x.xxx DE4-28	1.174 - 1.220	2.50	0.96	0.906	1.004	BTDO028	BTDI020	1.102	○	○	○
BTA x.xxx DE4-30.5	1.221 - 1.264	2.50	0.96	1.004	1.102	BTDO030.5	BTDI022	1.201	○	○	○
BTA x.xxx DE4-30.5	1.264 - 1.311	2.50	0.96	1.004	1.102	BTDO030.5	BTDI022	1.201	○	○	○
BTA x.xxx DE4-33	1.311 - 1.370	2.78	1.20	1.063	1.181	BTDO033.0	BTDI024	1.299	○	○	○
BTA x.xxx DE4-33	1.370 - 1.425	2.78	1.20	1.063	1.181	BTDO033.0	BTDI024	1.299	○	○	○
BTA x.xxx DE4-35.5	1.426 - 1.469	2.89	1.20	1.181	1.299	BTDO035.5	BTDI026	1.398	○	○	○
BTA x.xxx DE4-35.5	1.469 - 1.512	2.89	1.20	1.181	1.299	BTDO035.5	BTDI026	1.398	○	○	○
BTA x.xxx DE4-35.5	1.512 - 1.559	2.89	1.20	1.181	1.299	BTDO035.5	BTDI026	1.398	○	○	○

Operating guidelines on [page 714](#).

○ = on request

BTA DRILL BRAZED - BTA-SERIES

DOUBLE TUBE SYSTEM - OUTER FOUR START THREAD

Diameter
1.559 - 2.559

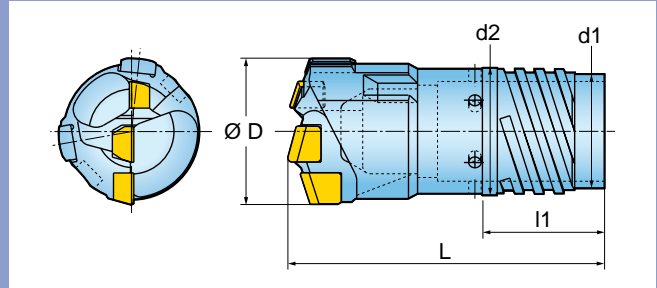

Designation	D	Dimension				Tube			Grade		
		L	l1	d1	d2	Outer tube	Inner tube	Diameter	TB103	TB203	TB253
BTA x.xxx DE4-39	1.559 - 1.598	2.89	1.20	1.299	1.417	BTDO039	BTDI029	1.535	○	○	○
BTA x.xxx DE4-39	1.599 - 1.646	2.89	1.20	1.299	1.417	BTDO039	BTDI029	1.535	○	○	○
BTA x.xxx DE4-39	1.646 - 1.693	2.89	1.20	1.299	1.417	BTDO039	BTDI029	1.535	○	○	○
BTA x.xxx DE4-42.5	1.693 - 1.744	2.95	1.20	1.417	1.535	BTDO042.5	BTDI032	1.673	○	○	○
BTA x.xxx DE4-42.5	1.744 - 1.795	2.95	1.20	1.417	1.535	BTDO042.5	BTDI032	1.673	○	○	○
BTA x.xxx DE4-42.5	1.796 - 1.850	2.95	1.20	1.417	1.535	BTDO042.5	BTDI032	1.673	○	○	○
BTA x.xxx DE4-46.5	1.851 - 1.909	3.11	1.36	1.555	1.693	BTDO046.5	BTDI035	1.831	○	○	○
BTA x.xxx DE4-46.5	1.910 - 1.972	3.11	1.36	1.555	1.693	BTDO046.5	BTDI035	1.831	○	○	○
BTA x.xxx DE4-46.5	1.973 - 2.035	3.11	1.36	1.555	1.693	BTDO046.5	BTDI035	1.831	○	○	○
BTA x.xxx DE4-51	2.036 - 2.094	3.23	1.36	1.713	1.850	BTDO051	BTDI039	2.008	○	○	○
BTA x.xxx DE4-51	2.095 - 2.154	3.23	1.36	1.713	1.850	BTDO051	BTDI039	2.008	○	○	○
BTA x.xxx DE4-51	2.154 - 2.213	3.23	1.36	1.713	1.850	BTDO051	BTDI039	2.008	○	○	○
BTA x.xxx DE4-55.5	2.213 - 2.299	3.31	1.36	1.870	2.008	BTDO055.5	BTDI043A	2.185	○	○	○
BTA x.xxx DE4-55.5	2.300 - 2.386	3.31	1.36	1.870	2.008	BTDO055.5	BTDI043A	2.185	○	○	○
BTA x.xxx DE4-55.5	2.386 - 2.472	3.31	1.36	1.870	2.008	BTDO055.5	BTDI043A	2.185	○	○	○
BTA x.xxx DE4-55.5	2.473 - 2.559	3.31	1.36	1.870	2.008	BTDO055.5	BTDI043A	2.185	○	○	○

Operating guidelines on [page 714](#).

○ = on request

BTA DRILL BRAZED - BTS-SERIES

SINGLE TUBE SYSTEM - OUTER TWO START AND FOUR START THREAD

Diameter
0.496 - 0.787

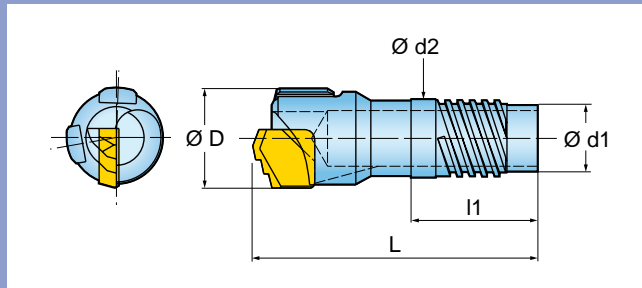

Designation	D	L	Dimension			Tube		Grade TB203
			l1	d1	d2	Part No.	Diameter	
BTS x.xxx SE2-11 *	0.496 - 0.535	1.68	0.81	0.323	0.378	BTSI011	0.433	○
BTS x.xxx SE2-12 *	0.536 - 0.575	1.68	0.89	0.362	0.417	BTSI012	0.472	○
BTS x.xxx SE2-13 *	0.575 - 0.614	1.68	0.89	0.402	0.457	BTSI013	0.512	○
BTS x.xxx SE4-14	0.615 - 0.657	1.70	0.89	0.425	0.496	BTSI014	0.551	○
BTS x.xxx SE4-15	0.658 - 0.697	1.70	0.89	0.465	0.535	BTSI015	0.591	○
BTS x.xxx SE4-16	0.697 - 0.744	1.72	0.89	0.492	0.571	BTSI016	0.630	○
BTS x.xxx SE4-17	0.744 - 0.787	1.72	0.89	0.531	0.610	BTSI017	0.669	○

* With outer two start thread
Operating guidelines on [page 714](#).

○ = on request

BTA DRILL BRAZED - BTS-SERIES

SINGLE TUBE SYSTEM - OUTER SINGLE START THREAD

Diameter
0.315 - 0.570

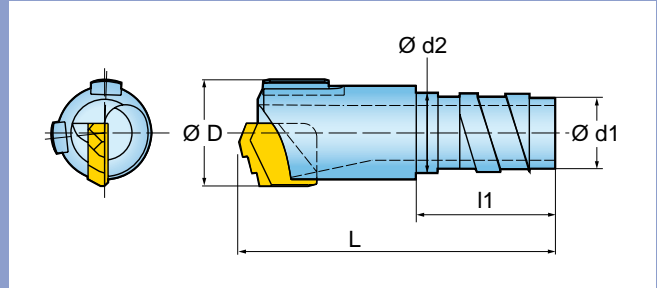

Designation	D	L	Dimension			Tube		Grade TB203
			l1	d1	d2	Part No.	Diameter	
BTS x.xxx SE1-7.1	0.315 - 0.354	1.40	0.63	0.213	0.236	BTSO071	0.280	○
BTS x.xxx SE1-8.3	0.354 - 0.393	1.40	0.63	0.248	0.283	BTSO083	0.327	○
BTS x.xxx SE1-9	0.394 - 0.433	1.41	0.63	0.264	0.299	BTSO090	0.354	○
BTS x.xxx SE1-10	0.433 - 0.472	1.41	0.63	0.303	0.339	BTSO100	0.394	○
BTS x.xxx SE1-11	0.472 - 0.531	1.41	0.63	0.323	0.358	BTSO110	0.433	○
BTS x.xxx SE1-12	0.531 - 0.570	1.42	0.63	0.370	0.425	BTSO120	0.472	○

Operating guidelines on [page 714](#).

○ = on request

BTA DRILL BRAZED - BTS-SERIES

SINGLE TUBE SYSTEM - INNER SINGLE START THREAD

Diameter
0.571 - 2.559

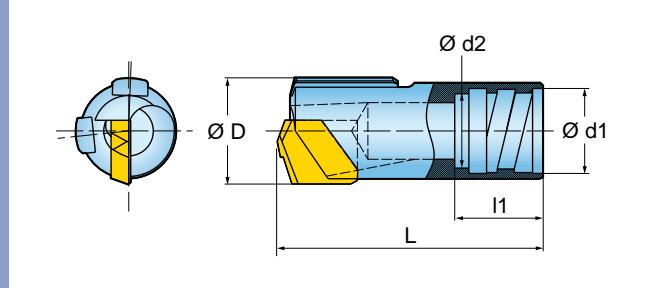

Designation	D	L	Dimension			Tube		Grade TB203
			l1	d1	d2	Part No.	Diameter	
BTS x.xxx SI1-12	0.571 - 0.591	2.06	0.91	0.453	0.390	BTSE012A	0.472	○
BTS x.xxx SI1-12	0.591 - 0.610	2.06	0.91	0.465	0.402	BTSE012B	0.472	○
BTS x.xxx SI1-13	0.611 - 0.630	2.06	0.91	0.488	0.425	BTSE013A	0.512	○
BTS x.xxx SI1-13	0.630 - 0.650	2.06	0.91	0.500	0.437	BTSE013B	0.512	○
BTS x.xxx SI1-14	0.650 - 0.679	2.07	0.91	0.528	0.465	BTSE014A	0.551	○
BTS x.xxx SI1-14	0.680 - 0.709	2.07	0.91	0.539	0.476	BTSE014B	0.551	○
BTS x.xxx SI1-15	0.709 - 0.748	2.08	0.91	0.567	0.504	BTSE015	0.591	○
BTS x.xxx SI1-16.5	0.748 - 0.787	2.08	0.91	0.606	0.543	BTSE016.5	0.650	○
BTS x.xxx SI1-18	0.787 - 0.866	2.44	0.98	0.650	0.571	BTSE018	0.709	○
BTS x.xxx SI1-20	0.866 - 0.984	2.46	0.98	0.748	0.630	BTSE020	0.787	○
BTS x.xxx SI1-22	0.984 - 1.063	2.74	0.98	0.787	0.669	BTSE022	0.866	○
BTS x.xxx SI1-24	1.063 - 1.181	2.76	0.98	0.866	0.748	BTSE024	0.945	○
BTS x.xxx SI1-26	1.181 - 1.259	2.97	0.98	0.945	0.827	BTSE026	1.024	○
BTS x.xxx SI1-28	1.260 - 1.338	3.37	0.98	1.024	0.906	BTSE028	1.102	○
BTS x.xxx SI1-30	1.339 - 1.456	3.39	1.57	1.063	0.945	BTSE030	1.181	○
BTS x.xxx SI1-32	1.457 - 1.574	3.39	1.57	1.181	1.063	BTSE032	1.260	○
BTS x.xxx SI1-36	1.575 - 1.732	3.41	1.57	1.299	1.181	BTSE036	1.417	○
BTS x.xxx SI1-39	1.732 - 1.850	3.82	1.57	1.457	1.339	BTSE039	1.535	○
BTS x.xxx SI1-43	1.850 - 2.047	3.83	1.57	1.614	1.457	BTSE043	1.693	○
BTS x.xxx SI1-47	2.047 - 2.244	3.85	1.57	1.732	1.575	BTSE047	1.850	○
BTS x.xxx SI1-51	2.244 - 2.401	3.87	1.57	1.929	1.772	BTSE051	2.008	○
BTS x.xxx SI1-56	2.402 - 2.559	3.89	1.57	2.087	1.929	BTSE056	2.205	○

Operating guidelines on [page 714](#).

○ = on request

BTA DRILLS BRAZED

GRADES COMBINATION per ISO APPLICATION

		10	20	30	40	50
P	Steel			TB253		
		TB103	TB203			
M	Stainless steel			TB253		
K	Cast iron		TB293			
N	Non-ferrous material		TB293			

APPLICATION OF GRADE COMBINATIONS

Machine & working conditions	Poor	Medium	Good
Recommended Grade	TB253		
		TB203	
			TB103

ITEMIZED GRADE COMBINATIONS

Item	Standard Grade	Semi-standard Grade	Special Grade
BTA	TB253	TB103 TB203	TB293
BTS	TB203		

All listed grades are coated with TiAN. TiN-coatings are available on request.

BTA INDEXABLE REAMERS - INSERTS - TBTA-R SERIES

INSERTS

TPMX

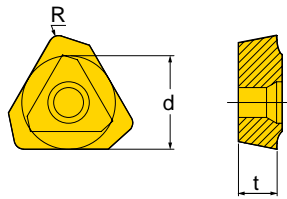

XPMT

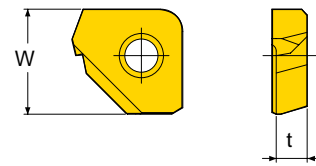

Designation	Dimension				Pocket			Grade IN2005	Screw
	d	t	R	W	Center	Inner	Outer		
TPMX 1403LG	0.333	0.138	0.031	-			○	CSTB2.5	
TPMX 1704LG	0.406	0.157	0.031	-			○	CSTB3.5D	
TPMX 2405LG	0.559	0.217	0.047	-			○	CSTB4M	
XPMT 16002-45	-	0.106	-	0.374			○	CSTA3	

For use in holder TBTA-R, [page 643](#).

PAD

Guide pad

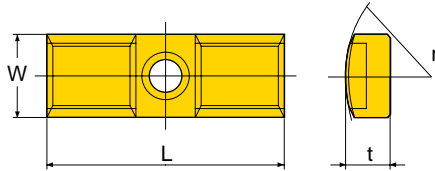

Resin guide pad

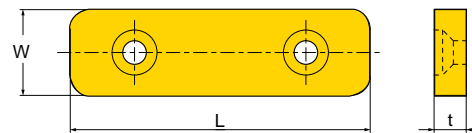

Type	Designation	Dimension				Screw
		W	t	L	r	
Guide pad	PAD-GC08-120	0.315	0.173	0.984	0.689	CSTB3S
	PAD-GC08	0.315	0.177	0.984	0.689	CSTB3S
	PAD-GC10	0.394	0.236	1.378	0.787	CSTB4S
	PAD-GC14	0.551	0.295	1.575	0.984	CSTA5S
	PAD-GC18	0.709	0.354	1.575	1.181	LS1206S
Resin guide pad	PAD-R10	0.394	0.157	1.575	-	LS0902.5-6
	PAD-R12	0.472	0.197	1.772	-	LS0903-8
	PAD-R15	0.591	0.228	1.969	-	LS0904-10
	PAD-R20	0.787	0.295	2.756	-	LS0905-12
	PAD-R30	1.181	0.492	3.150	-	LS0906-15
	PAD-R35	1.378	0.610	3.937	-	LS0906-15

For use in holder TBTA-R, [page 643](#).

CARTRIDGES FOR TBTA-R SERIES

CARTRIDGES FOR INDEXABLE REAMERS

Accurate applications

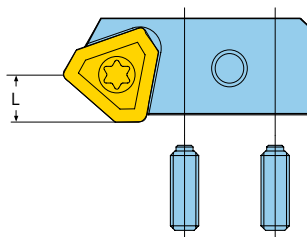

Open tolerance applications

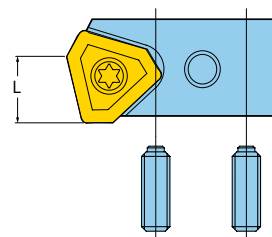

	Designation	L	Adjusting Screw	Wrench	Lock Screw	Wrench	Insert
Accurate tolerance applications	PERC-P04R	0.197	AS0004-8	H2	LS1803.5RH	H2.5	TPMX1403 LG
	PERC-P32R	0.236	AS0005-10	H2.5	LS1805RH	H3	TPMX1704 LG
	PERC-P43R	0.315	AS0005-15	H2.5	LS1806RH	H4	TPMX2405 LG
Open tolerance applications	PERC-402-04	0.315	AS0004-8	H2	LS1803.5RH	H2.5	TPMX1403 RG
	PERC-402-32	0.354	AS0005-10	H2.5	LS1805RH	H3	TPMX1704 RG
	PERC-402-43	0.512	AS0005-15	H2.5	LS1806RH	H4	TPMX2405 RG

* PERC-402- and PERC-P-cartridges are interchangeable in the same pocket.
For use in holder TBTA-R, [page 643](#).

BTA INDEXABLE REAMERS - TBTA-R SERIES

SINGLE TUBE SYSTEM - OUTER FOUR START THREAD

Diameter
0.984 - 1.574

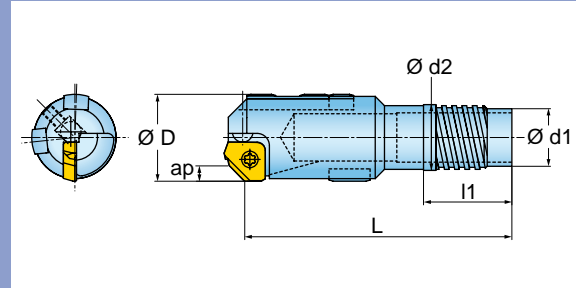

Designation	D	ap	L	Dimension			Tube	
				l1	d1	d2	Part No.	Diameter
TBTA-R-x.xxxSE4-22	0.984 - 1.039	0.14	2.76	0.85	0.689	0.768	BTSI 022	0.866
TBTA-R-x.xxxSE4-24	1.040 - 1.130	0.14	2.76	0.85	0.748	0.827	BTSI 024	0.945
TBTA-R-x.xxxSE4-26	1.130 - 1.220	0.14	2.95	0.96	0.827	0.925	BTSI 026	1.024
TBTA-R-x.xxxSE4-28	1.221 - 1.311	0.14	2.95	0.96	0.906	1.004	BTSI 028	1.102
TBTA-R-x.xxxSE4-30	1.311 - 1.425	0.14	2.95	0.96	1.004	1.102	BTSI 030	1.181
TBTA-R-x.xxxSE4-33	1.426 - 1.559	0.14	3.54	1.20	1.063	1.181	BTSI 033	1.299
TBTA-R-x.xxxSE4-36	1.559 - 1.574	0.14	3.54	1.20	1.181	1.299	BTSI 036	1.417

Inserts on [page 641](#).

Operating guidelines on [page 714](#).

BTA INDEXABLE REAMERS - TBTA-R SERIES

SINGLE TUBE SYSTEM - OUTER FOUR START THREAD

Diameter
1.575 - 3.898

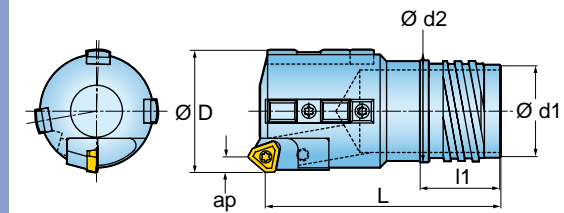

Designation	D	ap	L	Dimension			Tube	
				l1	d1	d2	Part No.	Diameter
TBTA-R-x.xxxSE4-36	1.575 - 1.693	0.20	3.54	1.20	1.181	1.299	BTSI 036	1.417
TBTA-R-x.xxxSE4-39	1.693 - 1.850	0.20	3.74	1.20	1.299	1.417	BTSI 039	1.535
TBTA-R-x.xxxSE4-43	1.851 - 2.035	0.20	3.94	1.20	1.417	1.535	BTSI 043	1.693
TBTA-R-x.xxxSE4-47	2.036 - 2.213	0.20	3.94	1.36	1.555	1.693	BTSI 047	1.850
TBTA-R-x.xxxSE4-51	2.213 - 2.386	0.24	4.13	1.36	1.713	1.850	BTSI 051	2.008
TBTA-R-x.xxxSE4-56	2.386 - 2.559	0.24	4.33	1.36	1.870	2.008	BTSI 056A	2.205
TBTA-R-x.xxxSE4-56	2.559 - 2.637	0.24	5.91	2.44	1.850	2.047	BTSI 056B	2.205
TBTA-R-x.xxxSE4-62	2.638 - 2.874	0.31	5.91	2.44	2.087	2.283	BTSI 062	2.441
TBTA-R-x.xxxSE4-68	2.874 - 3.149	0.31	5.91	2.44	2.283	2.480	BTSI 068	2.677
TBTA-R-x.xxxSE4-75	3.150 - 3.425	0.31	7.09	3.23	2.520	2.756	BTSI 075	2.953
TBTA-R-x.xxxSE4-82	3.425 - 3.937	0.31	7.09	3.23	2.795	3.031	BTSI 082	3.228

Inserts on [page 641](#).

Operating guidelines on [page 714](#).

BTA INDEXABLE REAMERS - TBTA-R SERIES

SINGLE TUBE SYSTEM - INNER SINGLE START THREAD

Diameter
0.984 - 1.574

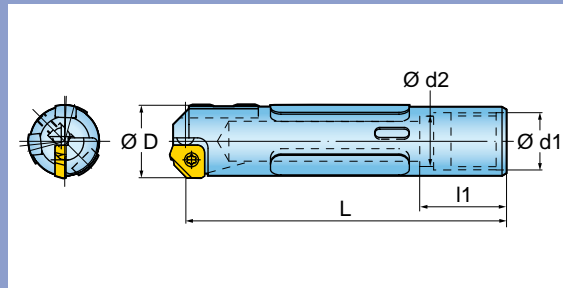

Designation	D	ap	L	Dimension			Tube	
				l1	d1	d2	Part No.	Diameter
TBTA-R-x.xxxSI1-22	0.984 - 1.063	0.14	4.33	0.98	0.787	0.669	BTSE 022	0.866
TBTA-R-x.xxxSI1-24	1.063 - 1.181	0.14	4.33	0.98	0.866	0.748	BTSE 024	0.945
TBTA-R-x.xxxSI1-26	1.181 - 1.259	0.14	4.33	0.98	0.945	0.827	BTSE 026	1.024
TBTA-R-x.xxxSI1-28	1.260 - 1.338	0.14	4.33	0.98	1.024	0.906	BTSE 028	1.102
TBTA-R-x.xxxSI1-30	1.339 - 1.456	0.14	5.31	1.57	1.063	0.945	BTSE 030	1.181
TBTA-R-x.xxxSI1-33	1.457 - 1.574	0.14	5.31	1.57	1.181	1.063	BTSE 033	1.299

Inserts on [page 641](#).
Operating guidelines on [page 714](#).

BTA INDEXABLE REAMERS - TBTA-R SERIES

SINGLE TUBE SYSTEM - INNER SINGLE START THREAD

Diameter
1.575 - 4.370

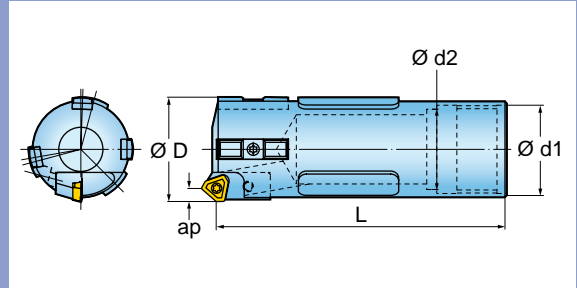

Designation	D	ap	L	Dimension			Tube	
				l1	d1	d2	Part No.	Diameter
TBTA-R-x.xxxS11-36	1.575 - 1.732	0.10	5.31	1.57	1.299	1.181	BTSE 036	1.417
TBTA-R-x.xxxS11-39	1.732 - 1.850	0.10	5.31	1.57	1.457	1.339	BTSE 039	1.535
TBTA-R-x.xxxS11-43	1.850 - 2.047	0.10	5.71	1.57	1.614	1.457	BTSE 043	1.693
TBTA-R-x.xxxS11-47	2.047 - 2.244	0.16	5.71	1.57	1.732	1.575	BTSE 047	1.850
TBTA-R-x.xxxS11-51	2.244 - 2.401	0.16	6.69	1.57	1.929	1.772	BTSE 051	2.008
TBTA-R-x.xxxS11-56	2.402 - 2.677	0.16	6.69	1.57	2.087	1.929	BTSE 056	2.205
TBTA-R-x.xxxS11-62	2.677 - 2.952	0.20	6.69	1.57	2.323	2.126	BTSE 062	2.441
TBTA-R-x.xxxS11-68	2.953 - 3.189	0.20	8.07	2.76	2.559	2.362	BTSE 068	2.677
TBTA-R-x.xxxS11-75	3.189 - 3.582	0.20	8.07	2.76	2.795	2.598	BTSE 075	2.953
TBTA-R-x.xxxS11-82	3.583 - 3.897	0.20	8.46	2.76	3.110	2.913	BTSE 082	3.228
TBTA-R-x.xxxS11-94	3.898 - 4.370	0.20	8.46	2.76	3.543	3.346	BTSE 094	3.701

Inserts on [page 641](#).
Operating guidelines on [page 714](#).

BTA INDEXABLE REAMERS - TBTA-R SERIES

ASSEMBLY OF TBTA-R SERIES

Diameter
0.984 - 1.574

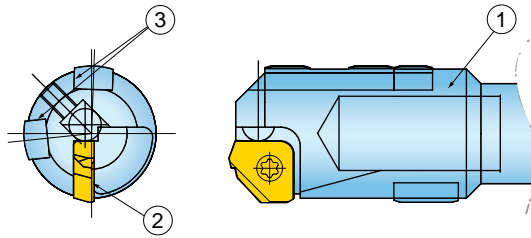

1. Head shank
2. Cartridge and lock screw
3. Guide pad

Parts			Diameter			
			0.984 - 1.102	1.102 - 1.181	1.181 - 1.496	1.496 - 1.574
Close Tolerances	Cartridge	Cartridge	-	-	-	-
		Adjust Screw	-	-	-	-
		Wrench	-	-	-	-
		Screw	-	-	-	-
		Wrench	-	-	-	-
	Insert	Insert	XPMT 16002-45	XPMT 16002-45	XPMT 16002-45	XPMT 16002-45
Screw		CSTAN03	CSTAN03	CSTAN03	CSTAN03	
Wrench		T9	T9	T9	T9	
Normal Tolerances	Cartridge	Outer	-	-	-	-
		Adjust Screw	-	-	-	-
		Wrench	-	-	-	-
		Screw	-	-	-	-
		Wrench	-	-	-	-
	Insert	Inner	XPMT 16002-45	XPMT 16002-45	XPMT 16002-45	XPMT 16002-45
Screw		CSTAN03	CSTAN03	CSTAN03	CSTAN03	
Wrench		T9	T9	T9	T9	
Pad	Guide Pad (A)	PAD-GC08-120	PAD-GC08-120	PAD-GC08-140	PAD-GC08	
	Screw	CSTB3S	CSTB3S	CSTB3S	CSTB3S	
	Wrench	T9	T9	T9	T9	
	Guide Pad Protector (B)	PAD-P08-120	PAD-P08-120	PAD-P08-140	PAD-P08	
	Screw	CSTB3S	CSTB3S	CSTB3S	CSTB3S	
	Wrench	T9	T9	T9	T9	
	Resin Guide Pad (C)	PAD-R10	PAD-R10	PAD-R12	PAD-R15	
Screw	LS0902	LS0902	LS0903	LS0904		
Wrench	+	+	+	+		

A + B is for outer four start thread connection type.
A + C is for inner single start thread connection type.

BTA INDEXABLE REAMERS - TBTA-R SERIES

ASSEMBLY OF TBTA-R SERIES

Diameter
1.575 - 2.637

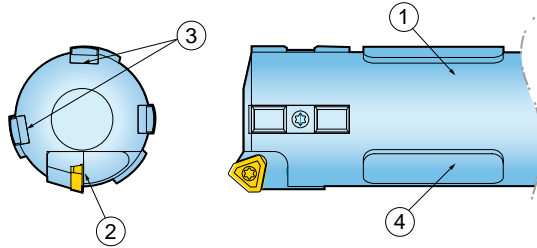

1. Head shank
2. Cartridge and lock screw
3. Guide pad
4. Resin guide pad and lock screw

Parts			Diameter				
			1.575 - 1.811	1.811 - 2.047	2.047 - 2.362	2.362 - 2.637	
Close Tolerances	Cartridge	Cartridge	PERC-P 04R	PERC-P 04R	PERC-P 32R	PERC-P 32R	
		Adjust Screw	AS0004-8	AS0004-8	AS0005-10	AS0005-10	
		Wrench	H2	H2	H2.5	H2.5	
		Screw	LS1803.5RH	LS1803.5RH	LS1805RH	LS1805RH	
		Wrench	H2.5	H2.5	H3	H3	
	Insert	Insert	TPMX 1403LG	TPMX 1403LG	TPMX 1704LG	TPMX 1704LG	
		Screw	CSTB2.5	CSTB2.5	CSTB3.5D	CSTB3.5D	
		Wrench	T8	T8	T9	T9	
	Normal Tolerances	Cartridge	Outer	PERC 402-04	PERC 402-04	PERC 402-32	PERC 402-32
			Adjust Screw	AS0004-8	AS0004-8	AS0005-10	AS0005-10
Wrench			H2	H2	H2.5	H2.5	
Screw			LS1803.5RH	LS1803.5RH	LS1805RH	LS1805RH	
Wrench			H2.5	H2.5	H3	H3	
Insert		Inner	TPMX 1403RG	TPMX 1403RG	TPMX 1704RG	TPMX 1704RG	
		Screw	CSTB2.5	CSTB2.5	CSTB3.5D	CSTB3.5D	
		Wrench	T8	T8	T9	T9	
Pad		Guide Pad (A)	Guide Pad (A)	PAD-GC08	PAD-GC10	PAD-GC10	PAD-GC14
	Screw		CSTB3S	CSTB4S	CSTB4S	CSTA5S	
	Wrench		T9	T9	T9	T15	
	Guide Pad Protector (B)	Guide Pad Protector (B)	PAD-P08	PAD-P10	PAD-P10	PAD-P14	
		Screw	CSTB3S	CSTB4S	CSTB4S	CSTA5S	
		Wrench	T9	T15	T15	T15	
	Resin Guide Pad (C)	Resin Guide Pad (C)	PAD-R15	PAD-R15	PAD-R15	PAD-R20	
		Screw	LS0904	LS0904	LS0904	LS0905	
		Wrench	+	+	+	+	

A + B is for outer four start thread connection type.
A + C is for inner single start thread connection type.

BTA INDEXABLE REAMERS - TBTA-R SERIES

ASSEMBLY OF TBTA-R SERIES

Diameter
2.638 - 4.842

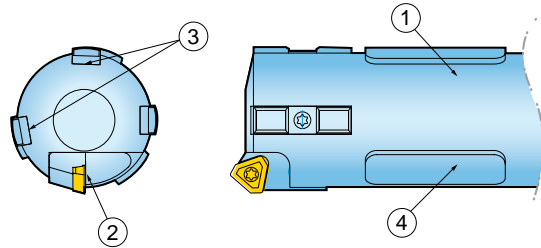

1. Head shank
2. Cartridge and lock screw
3. Guide pad
4. Resin guide pad and lock screw

Parts			Diameter			
			2.638 - 3.189	3.189 - 3.582	3.583 - 3.937	3.937 - 4.842
Close Tolerances	Cartridge	Cartridge	PERC-P 43R	PERC-P 43R	PERC-P 43R	PERC-P 43R
		Adjust Screw	AS0005-15	AS0005-15	AS0005-15	AS0005-15
		Wrench	H2.5	H2.5	H2.5	H2.5
		Screw	LS1806RH	LS1806RH	LS1806RH	LS1806RH
		Wrench	H4	H4	H4	H4
	Insert	Insert	TPMX 2405LG	TPMX 2405LG	TPMX 2405LG	TPMX 2405LG
Screw		CSTB4M	CSTB4M	CSTB4M	CSTB4M	
Wrench		T15	T15	T15	T15	
Normal Tolerances	Cartridge	Outer	PERC 402-43	PERC 402-43	PERC 402-43	PERC 402-43
		Adjust Screw	AS0005-15	AS0005-15	AS0005-15	AS0005-15
		Wrench	H2.5	H2.5	H2.5	H2.5
		Screw	LS1806RH	LS1806RH	LS1806RH	LS1806RH
		Wrench	H4	H4	H4	H4
	Insert	Inner	TPMX 2405RG	TPMX 2405RG	TPMX 2405RG	TPMX 2405RG
Screw		CSTB4M	CSTB4M	CSTB4M	CSTB4M	
Wrench		T15	T15	T15	T15	
Pad	Guide Pad (A)	PAD-GC14	PAD-GC14	PAD-GC14	PAD-GC18	
	Screw	CSTA5S	CSTA5S	CSTA5S	LS1206S	
	Wrench	T15	T15	T15	T15	
	Guide Pad Protector (B)	PAD-P14	PAD-P14	PAD-P14	PAD-P18	
	Screw	CSTA5S	CSTA5S	CSTA5S	LS1206S	
	Wrench	T15	T15	T15	H3	
	Resin Guide Pad (C)	PAD-R20	PAD-R30	PAD-R35	PAD-R35	
	Screw	LS0905	LS0906	LS0906	LS0906	
Wrench	+	+	+	+		

A + B is for outer four start thread connection type.
A + C is for inner single start thread connection type.

HEAD CHANGE REAMERS - BTA-R SERIES

SINGLE TUBE SYSTEM - INNER SINGLE START THREAD

Diameter
0.571- 2.559

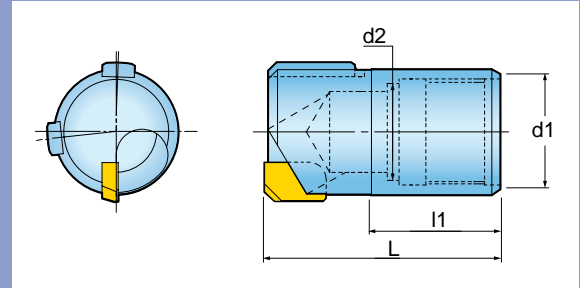

Designation	D	Dimension				Tube		Grade TB103
		L	l1	d1	d2	Part No.	Diameter	
BTA-Rx.xxxSI1-12-xxx	0.571 - 0.591	2.05	0.91	0.453	0.390	BTSE012A	0.472	○
BTA-Rx.xxxSI1-12-xxx	0.591 - 0.610	2.05	0.91	0.465	0.402	BTSE012B	0.472	○
BTA-Rx.xxxSI1-13-xxx	0.611 - 0.630	2.05	0.91	0.488	0.425	BTSE013A	0.512	○
BTA-Rx.xxxSI1-13-xxx	0.630 - 0.650	2.05	0.91	0.500	0.437	BTSE013B	0.512	○
BTA-Rx.xxxSI1-14-xxx	0.650 - 0.679	2.05	0.91	0.528	0.465	BTSE014A	0.551	○
BTA-Rx.xxxSI1-14-xxx	0.680 - 0.709	2.05	0.91	0.539	0.476	BTSE014B	0.551	○
BTA-Rx.xxxSI1-15-xxx	0.709 - 0.748	2.05	0.91	0.567	0.504	BTSE015	0.591	○
BTA-Rx.xxxSI1-16.5-xxx	0.748 - 0.787	2.24	0.91	0.606	0.543	BTSE016.5	0.650	○
BTA-Rx.xxxSI1-18-xxx	0.787 - 0.866	2.24	0.98	0.650	0.571	BTSE018	0.709	○
BTA-Rx.xxxSI1-20-xxx	0.866 - 0.984	2.24	0.98	0.748	0.630	BTSE020	0.787	○
BTA-Rx.xxxSI1-22-xxx	0.984 - 1.063	2.64	0.98	0.787	0.669	BTSE022	0.866	○
BTA-Rx.xxxSI1-24-xxx	1.063 - 1.181	2.64	0.98	0.866	0.748	BTSE024	0.945	○
BTA-Rx.xxxSI1-26-xxx	1.181 - 1.259	2.64	0.98	0.945	0.827	BTSE026	1.024	○
BTA-Rx.xxxSI1-28-xxx	1.260 - 1.338	3.15	0.98	1.024	0.906	BTSE028	1.102	○
BTA-Rx.xxxSI1-30-xxx	1.339 - 1.456	3.15	1.57	1.063	0.945	BTSE030	1.181	○
BTA-Rx.xxxSI1-32-xxx	1.457 - 1.574	3.15	1.57	1.181	1.063	BTSE032	1.260	○
BTA-Rx.xxxSI1-36-xxx	1.575 - 1.732	3.54	1.57	1.299	1.181	BTSE036	1.417	○
BTA-Rx.xxxSI1-39-xxx	1.732 - 1.850	3.54	1.57	1.457	1.339	BTSE039	1.535	○
BTA-Rx.xxxSI1-43-xxx	1.850 - 2.047	3.54	1.57	1.614	1.457	BTSE043	1.693	○
BTA-Rx.xxxSI1-47-xxx	2.047 - 2.244	3.54	1.57	1.732	1.575	BTSE047	1.850	○
BTA-Rx.xxxSI1-51-xxx	2.244 - 2.401	3.54	1.57	1.929	1.772	BTSE051	2.008	○
BTA-Rx.xxxSI1-56-xxx	2.402 - 2.559	3.54	1.57	2.087	1.929	BTSE056	2.205	○

Example: BTA-R0.571SI1-12-B45

- Diameter of reamer: 0.571"
- B = chip backward design (F = chip forward design is available for through holes)
- Entering angle: 45 deg.

Operating guidelines on [page 714](#).

○ = on request

HEAD CHANGE REAMERS - BTA-R SERIES

SINGLE TUBE SYSTEM - OUTER FOUR START THREAD

Diameter
0.744 - 2.559

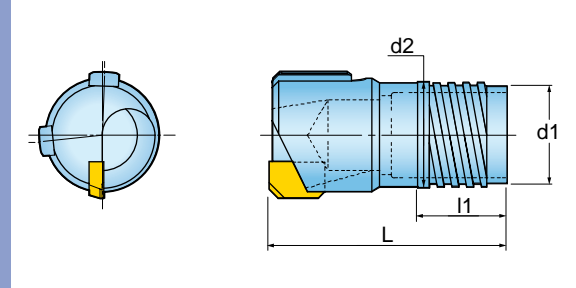

Designation	D	Dimension				Part No.	Tube Diameter	Grade TB103
		L	l1	d1	d2			
BTA-Rx.xxxSE4-17-xxx	0.744 - 0.756	2.24	1.74	0.531	0.610	BTSI017	0.669	○
BTA-Rx.xxxSE4-17-xxx	0.756 - 0.787	2.24	1.73	0.531	0.610	BTSI017	0.669	○
BTA-Rx.xxxSE4-18-xxx	0.788 - 0.823	2.56	1.94	0.551	0.630	BTSI018	0.709	○
BTA-Rx.xxxSE4-18-xxx	0.823 - 0.858	2.56	1.94	0.551	0.630	BTSI018	0.709	○
BTA-Rx.xxxSE4-20-xxx	0.859 - 0.902	2.56	2.08	0.630	0.709	BTSI020	0.787	○
BTA-Rx.xxxSE4-20-xxx	0.902 - 0.949	2.56	2.07	0.630	0.709	BTSI020	0.787	○
BTA-Rx.xxxSE4-22-xxx	0.949 - 0.992	2.56	2.13	0.689	0.768	BTSI022	0.866	○
BTA-Rx.xxxSE4-22-xxx	0.993 - 1.039	2.56	2.13	0.689	0.768	BTSI022	0.866	○
BTA-Rx.xxxSE4-24-xxx	1.040 - 1.083	2.56	2.12	0.748	0.827	BTSI024	0.945	○
BTA-Rx.xxxSE4-24-xxx	1.083 - 1.130	2.56	2.12	0.748	0.827	BTSI024	0.945	○
BTA-Rx.xxxSE4-26-xxx	1.130 - 1.173	2.76	2.34	0.827	0.925	BTSI026	1.024	○
BTA-Rx.xxxSE4-26-xxx	1.174 - 1.220	2.76	2.33	0.827	0.925	BTSI026	1.024	○
BTA-Rx.xxxSE4-28-xxx	1.221 - 1.264	2.76	2.34	0.906	1.004	BTSI028	1.102	○
BTA-Rx.xxxSE4-28-xxx	1.264 - 1.311	2.76	2.33	0.906	1.004	BTSI028	1.102	○
BTA-Rx.xxxSE4-30-xxx	1.311 - 1.370	2.76	2.32	1.004	1.102	BTSI030	1.181	○
BTA-Rx.xxxSE4-30-xxx	1.370 - 1.425	2.76	2.32	1.004	1.102	BTSI030	1.181	○
BTA-Rx.xxxSE4-33-xxx	1.426 - 1.469	3.23	2.70	1.063	1.181	BTSI033	1.299	○
BTA-Rx.xxxSE4-33-xxx	1.469 - 1.512	3.23	2.70	1.063	1.181	BTSI033	1.299	○
BTA-Rx.xxxSE4-33-xxx	1.512 - 1.559	3.23	2.69	1.063	1.181	BTSI033	1.299	○
BTA-Rx.xxxSE4-36-xxx	1.559 - 1.598	3.23	2.69	1.181	1.299	BTSI036	1.417	○
BTA-Rx.xxxSE4-36-xxx	1.599 - 1.646	3.23	2.68	1.181	1.299	BTSI036	1.417	○
BTA-Rx.xxxSE4-36-xxx	1.646 - 1.693	3.23	2.67	1.181	1.299	BTSI036	1.417	○
BTA-Rx.xxxSE4-39-xxx	1.693 - 1.744	3.23	2.74	1.299	1.417	BTSI039	1.535	○
BTA-Rx.xxxSE4-39-xxx	1.744 - 1.795	3.23	2.73	1.299	1.417	BTSI039	1.535	○
BTA-Rx.xxxSE4-39-xxx	1.796 - 1.850	3.23	2.72	1.299	1.417	BTSI039	1.535	○
BTA-Rx.xxxSE4-43-xxx	1.851 - 1.909	3.23	2.71	1.417	1.535	BTSI043	1.693	○
BTA-Rx.xxxSE4-43-xxx	1.910 - 1.972	3.23	2.70	1.417	1.535	BTSI043	1.693	○
BTA-Rx.xxxSE4-43-xxx	1.973 - 2.035	3.23	2.70	1.417	1.535	BTSI043	1.693	○
BTA-Rx.xxxSE4-47-xxx	2.036 - 2.094	3.66	2.96	1.555	1.693	BTSI047	1.850	○
BTA-Rx.xxxSE4-47-xxx	2.095 - 2.154	3.66	2.96	1.555	1.693	BTSI047	1.850	○
BTA-Rx.xxxSE4-47-xxx	2.154 - 2.213	3.66	2.96	1.555	1.693	BTSI047	1.850	○
BTA-Rx.xxxSE4-51-xxx	2.213 - 2.299	3.66	3.05	1.713	1.850	BTSI051	2.008	○
BTA-Rx.xxxSE4-51-xxx	2.300 - 2.386	3.66	3.03	1.713	1.850	BTSI051	2.008	○
BTA-Rx.xxxSE4-56-xxx	2.386 - 2.472	3.66	3.02	1.870	2.008	BTSI056	2.205	○
BTA-Rx.xxxSE4-56-xxx	2.473 - 2.559	3.66	3.01	1.870	2.008	BTSI056	2.205	○

Example: BTA-RO.744SE4-12-B45 • B = Chip backward design (F = chip forward design, available for through holes) • Dia. of reamer: 0.744" • Entering angle: 45 deg.
Operating guidelines on [page 714](#).

○ = on request

HEAD CHANGE REAMERS BTA-R SERIES

SINGLE TUBE SYSTEM - OUTER FOUR START THREAD

Diameter
0.725 - 2.559

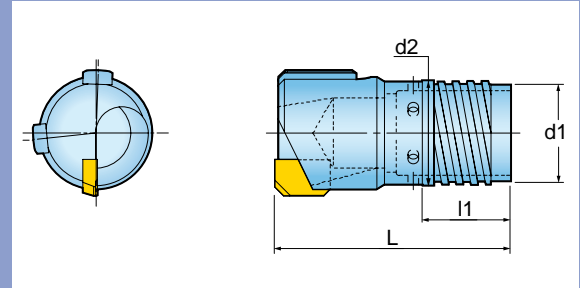

Designation	D	Dimension				Tube			Grade TB103
		L	l1	d1	d2	Outer tube	Inner tube	Diameter	
BTA-Rx.xxxDE4-18-xxx	0.725 - 0.756	2.24	0.85	0.551	0.630	BTDO018	BTDI012	0.709	○
BTA-Rx.xxxDE4-18-xxx	0.756 - 0.787	2.24	0.85	0.551	0.630	BTDO018	BTDI012	0.709	○
BTA-Rx.xxxDE4-19.5-xxx	0.796 - 0.823	2.56	0.85	0.630	0.709	BTDO019.5	BTDI014	0.768	○
BTA-Rx.xxxDE4-19.5-xxx	0.823 - 0.858	2.56	0.85	0.630	0.709	BTDO019.5	BTDI014	0.768	○
BTA-Rx.xxxDE4-21.5-xxx	0.859 - 0.902	2.56	0.85	0.689	0.768	BTDO021.5	BTDI015	0.846	○
BTA-Rx.xxxDE4-21.5-xxx	0.902 - 0.949	2.56	0.85	0.689	0.768	BTDO021.5	BTDI015	0.846	○
BTA-Rx.xxxDE4-23.5-xxx	0.949 - 0.992	2.56	0.85	0.748	0.827	BTDO023.5	BTDI016	0.925	○
BTA-Rx.xxxDE4-23.5-xxx	0.993 - 1.039	2.56	0.85	0.748	0.827	BTDO023.5	BTDI016	0.925	○
BTA-Rx.xxxDE4-26-xxx	1.040 - 1.083	2.56	0.96	0.827	0.925	BTDO026	BTDI018	1.024	○
BTA-Rx.xxxDE4-26-xxx	1.083 - 1.130	2.56	0.96	0.827	0.925	BTDO026	BTDI018	1.024	○
BTA-Rx.xxxDE4-28-xxx	1.130 - 1.173	2.76	0.96	0.906	1.004	BTDO028	BTDI020	1.102	○
BTA-Rx.xxxDE4-28-xxx	1.174 - 1.220	2.76	0.96	0.906	1.004	BTDO028	BTDI020	1.102	○
BTA-Rx.xxxDE4-30.5-xxx	1.221 - 1.264	2.76	0.96	1.004	1.102	BTDO030.5	BTDI022	1.201	○
BTA-Rx.xxxDE4-30.5-xxx	1.264 - 1.311	2.76	0.96	1.004	1.102	BTDO030.5	BTDI022	1.201	○
BTA-Rx.xxxDE4-33-xxx	1.311 - 1.370	2.76	1.20	1.063	1.181	BTDO033.0	BTDI024	1.299	○
BTA-Rx.xxxDE4-33-xxx	1.370 - 1.425	2.76	1.20	1.063	1.181	BTDO033.0	BTDI024	1.299	○
BTA-Rx.xxxDE4-35.5-xxx	1.426 - 1.469	3.23	1.20	1.181	1.299	BTDO035.5	BTDI026	1.398	○
BTA-Rx.xxxDE4-35.5-xxx	1.469 - 1.512	3.23	1.20	1.181	1.299	BTDO035.5	BTDI026	1.398	○
BTA-Rx.xxxDE4-35.5-xxx	1.512 - 1.559	3.23	1.20	1.181	1.299	BTDO035.5	BTDI026	1.398	○
BTA-Rx.xxxDE4-39-xxx	1.559 - 1.598	3.23	1.20	1.299	1.417	BTDO039	BTDI029	1.535	○
BTA-Rx.xxxDE4-39-xxx	1.599 - 1.646	3.23	1.20	1.299	1.417	BTDO039	BTDI029	1.535	○
BTA-Rx.xxxDE4-39-xxx	1.646 - 1.693	3.23	1.20	1.299	1.417	BTDO039	BTDI029	1.535	○
BTA-Rx.xxxDE4-42.5-xxx	1.693 - 1.744	3.23	1.20	1.417	1.535	BTDO042.5	BTDI032	1.673	○
BTA-Rx.xxxDE4-42.5-xxx	1.744 - 1.795	3.23	1.20	1.417	1.535	BTDO042.5	BTDI032	1.673	○
BTA-Rx.xxxDE4-42.5-xxx	1.796 - 1.850	3.23	1.20	1.417	1.535	BTDO042.5	BTDI032	1.673	○
BTA-Rx.xxxDE4-46.5-xxx	1.851 - 1.909	3.23	1.36	1.555	1.693	BTDO046.5	BTDI035	1.831	○
BTA-Rx.xxxDE4-46.5-xxx	1.910 - 1.972	3.23	1.36	1.555	1.693	BTDO046.5	BTDI035	1.831	○
BTA-Rx.xxxDE4-46.5-xxx	1.973 - 2.035	3.23	1.36	1.555	1.693	BTDO046.5	BTDI035	1.831	○
BTA-Rx.xxxDE4-51-xxx	2.036 - 2.094	3.66	1.36	1.713	1.850	BTDO051	BTDI039	2.008	○
BTA-Rx.xxxDE4-51-xxx	2.095 - 2.154	3.66	1.36	1.713	1.850	BTDO051	BTDI039	2.008	○
BTA-Rx.xxxDE4-51-xxx	2.154 - 2.213	3.66	1.36	1.713	1.850	BTDO051	BTDI039	2.008	○
BTA-Rx.xxxDE4-55.5-xxx	2.213 - 2.299	3.66	1.36	1.870	2.008	BTDO055.5	BTDI043A	2.185	○
BTA-Rx.xxxDE4-55.5-xxx	2.300 - 2.386	3.66	1.36	1.870	2.008	BTDO055.5	BTDI043A	2.185	○
BTA-Rx.xxxDE4-55.5-xxx	2.386 - 2.472	3.66	1.36	1.870	2.008	BTDO055.5	BTDI043A	2.185	○
BTA-Rx.xxxDE4-55.5-xxx	2.473 - 2.559	3.66	1.36	1.870	2.008	BTDO055.5	BTDI043A	2.185	○

Example: BTA-R0.726SE4-12-B45 • B = chip backward design (F = chip forward design, available for through holes) • Diameter of reamer: 0.726" • Entering angle: 45 deg. Operating guidelines on [page 714](#).

○ = on request

EXCHANGE HEADS

HEAD

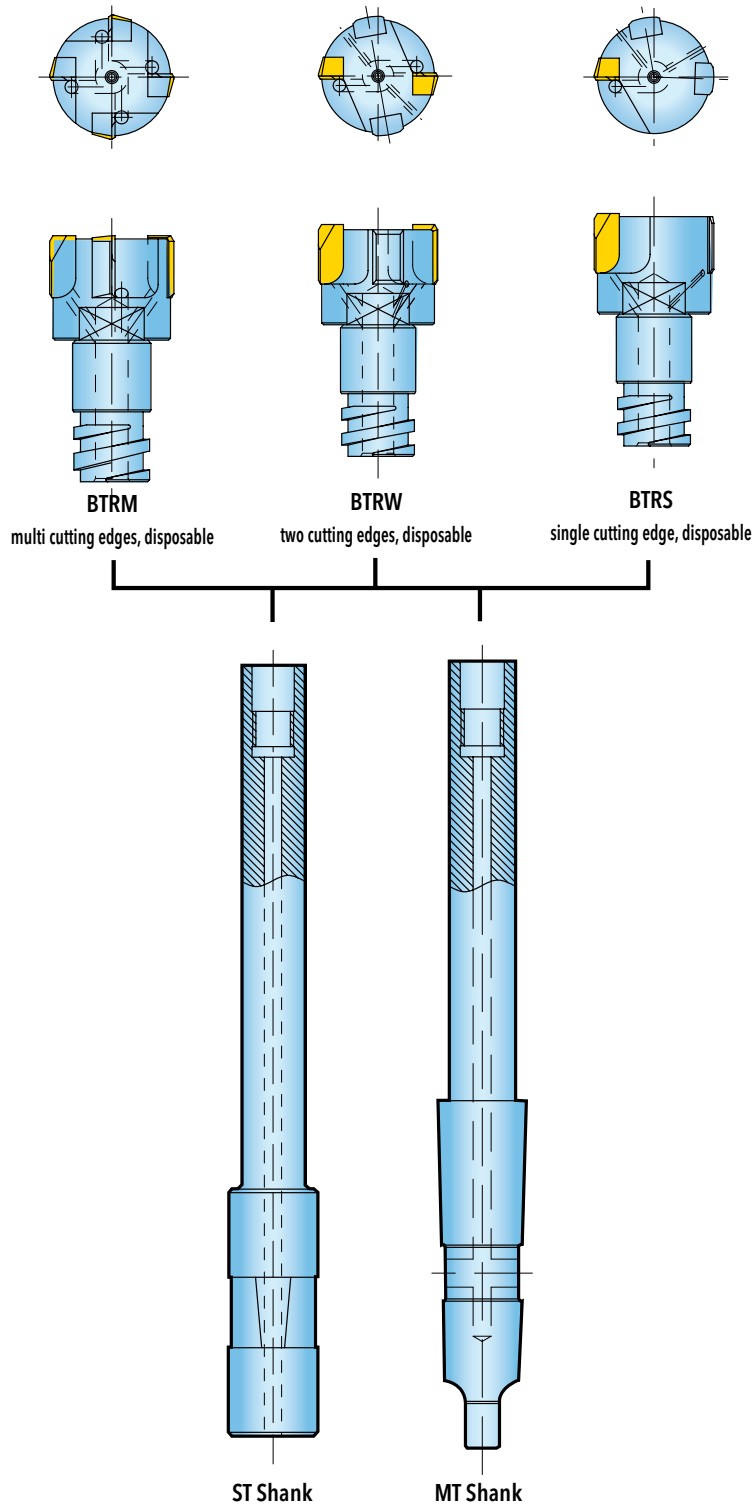

BTA REAMER HEAD BTRS SERIES - SHANK SYSTEM

REAMER HEAD BTRS

Diameter
0.236 - 0.984

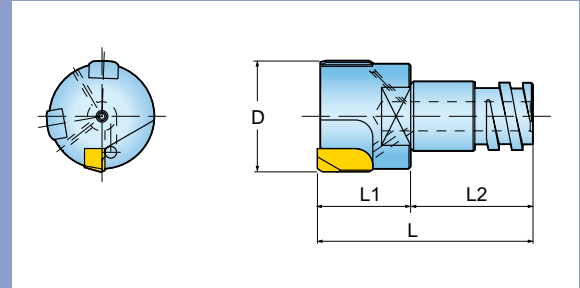

Designation	D	L	L1	L2	Bar
BTRS x.xxx 041	0.236 - 0.305	0.94	0.51	0.43	BTR04-xxx-xxx
BTRS x.xxx 051	0.305 - 0.344	0.98	0.51	0.47	BTR05-xxx-xxx
BTRS x.xxx 061	0.344 - 0.383	1.06	0.55	0.51	BTR06-xxx-xxx
BTRS x.xxx 071	0.384 - 0.433	1.14	0.59	0.55	BTR07-xxx-xxx
BTRS x.xxx 081	0.433 - 0.472	1.14	0.59	0.55	BTR08-xxx-xxx
BTRS x.xxx 091	0.472 - 0.511	1.18	0.59	0.59	BTR09-xxx-xxx
BTRS x.xxx 092	0.512 - 0.590	1.18	0.59	0.59	BTR09-xxx-xxx
BTRS x.xxx 101	0.591 - 0.630	1.26	0.63	0.63	BTR10-xxx-xxx
BTRS x.xxx 102	0.630 - 0.669	1.26	0.63	0.63	BTR10-xxx-xxx
BTRS x.xxx 103	0.669 - 0.708	1.26	0.63	0.63	BTR10-xxx-xxx
BTRS x.xxx 104	0.709 - 0.748	1.26	0.63	0.63	BTR10-xxx-xxx
BTRS x.xxx 121	0.748 - 0.787	1.46	0.63	0.83	BTR12-xxx-xxx
BTRS x.xxx 122	0.787 - 0.866	1.46	0.63	0.83	BTR12-xxx-xxx
BTRS x.xxx 123	0.866 - 0.944	1.46	0.63	0.83	BTR12-xxx-xxx
BTRS x.xxx 124	0.945 - 0.984	1.46	0.63	0.83	BTR12-xxx-xxx

* For high speed machining ceramic guides are available on request.
Operating guidelines on [page 714](#).

BTA REAMER HEAD BTRW SERIES - SHANK SYSTEM

REAMER HEAD BTRW

Diameter
0.236 - 0.984

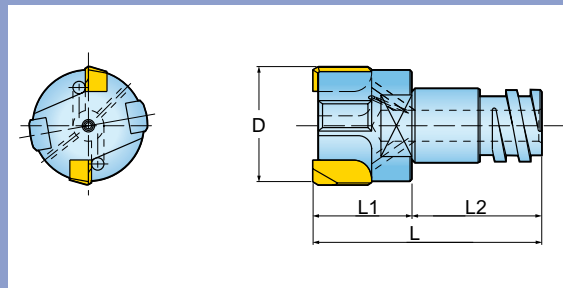

Designation	D	L	L1	L2	Bar
BTRW x.xxx 041	0.236 - 0.305	0.94	0.51	0.43	BTR04-xxx-xxx
BTRW x.xxx 051	0.305 - 0.344	0.98	0.51	0.47	BTR05-xxx-xxx
BTRW x.xxx 061	0.344 - 0.383	1.06	0.55	0.51	BTR06-xxx-xxx
BTRW x.xxx 071	0.384 - 0.433	1.14	0.59	0.55	BTR07-xxx-xxx
BTRW x.xxx 081	0.433 - 0.472	1.14	0.59	0.55	BTR08-xxx-xxx
BTRW x.xxx 091	0.472 - 0.511	1.18	0.59	0.59	BTR09-xxx-xxx
BTRW x.xxx 092	0.512 - 0.590	1.18	0.59	0.59	BTR09-xxx-xxx
BTRW x.xxx 101	0.591 - 0.630	1.26	0.63	0.63	BTR10-xxx-xxx
BTRW x.xxx 102	0.630 - 0.669	1.26	0.63	0.63	BTR10-xxx-xxx
BTRW x.xxx 103	0.669 - 0.708	1.26	0.63	0.63	BTR10-xxx-xxx
BTRW x.xxx 104	0.709 - 0.748	1.26	0.63	0.63	BTR10-xxx-xxx
BTRW x.xxx 121	0.748 - 0.787	1.46	0.63	0.83	BTR12-xxx-xxx
BTRW x.xxx 122	0.787 - 0.866	1.46	0.63	0.83	BTR12-xxx-xxx
BTRW x.xxx 123	0.866 - 0.944	1.46	0.63	0.83	BTR12-xxx-xxx
BTRW x.xxx 124	0.945 - 0.984	1.46	0.63	0.83	BTR12-xxx-xxx

*For high speed machining ceramic guides are available on request.
Operating guidelines on [page 714](#).

BTA REAMER HEAD BTRM SERIES - SHANK SYSTEM

REAMER HEAD BTRM

Diameter
0.236 - 0.984

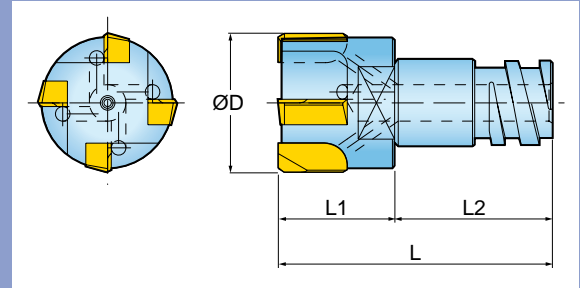

Designation	D	L	L1	L2	Bar
BTRM x.xxx 041	0.236 - 0.305	0.94	0.51	0.43	BTR04-xxx-xxx
BTRM x.xxx 051	0.305 - 0.344	0.98	0.51	0.47	BTR05-xxx-xxx
BTRM x.xxx 061	0.344 - 0.383	1.06	0.55	0.51	BTR06-xxx-xxx
BTRM x.xxx 071	0.384 - 0.433	1.14	0.59	0.55	BTR07-xxx-xxx
BTRM x.xxx 081	0.433 - 0.472	1.14	0.59	0.55	BTR08-xxx-xxx
BTRM x.xxx 091	0.472 - 0.511	1.18	0.59	0.59	BTR09-xxx-xxx
BTRM x.xxx 092	0.512 - 0.590	1.18	0.59	0.59	BTR09-xxx-xxx
BTRM x.xxx 101	0.591 - 0.630	1.26	0.63	0.63	BTR10-xxx-xxx
BTRM x.xxx 102	0.630 - 0.669	1.26	0.63	0.63	BTR10-xxx-xxx
BTRM x.xxx 103	0.669 - 0.708	1.26	0.63	0.63	BTR10-xxx-xxx
BTRM x.xxx 104	0.709 - 0.748	1.26	0.63	0.63	BTR10-xxx-xxx
BTRM x.xxx 121	0.748 - 0.787	1.46	0.63	0.83	BTR12-xxx-xxx
BTRM x.xxx 122	0.787 - 0.866	1.46	0.63	0.83	BTR12-xxx-xxx
BTRM x.xxx 123	0.866 - 0.944	1.46	0.63	0.83	BTR12-xxx-xxx
BTRM x.xxx 124	0.945 - 0.984	1.46	0.63	0.83	BTR12-xxx-xxx

* For high speed machining ceramic guides are available on request.
Operating guidelines on [page 714](#).

BT REAMER BAR FOR BTA REAMER HEADS

MT SHANK

Diameter
0.236 - 0.984

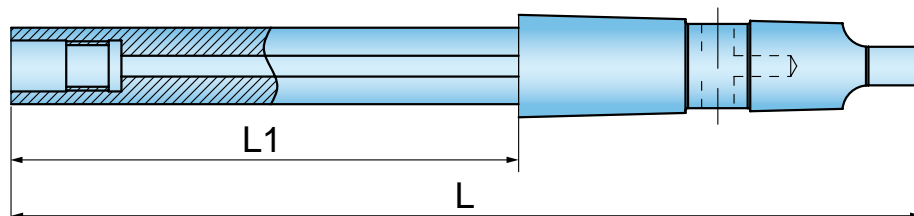

Designation	Diameter	L	L1	MT No.	Corresponding Reaming Head
BTR04-090-MT1	0.236 - 0.305	6.12	3.54	1	BTRW/S/M xx.xx 041
BTR05-100-MT1	0.305 - 0.344	6.52	3.94	1	BTRW/S/M xx.xx 051
BTR06-100-MT1	0.344 - 0.383	6.52	3.94	1	BTRW/S/M xx.xx 061
BTR07-120-MT2	0.384 - 0.433	7.87	4.72	2	BTRW/S/M xx.xx 071
BTR08-120-MT2	0.433 - 0.472	7.87	4.72	2	BTRW/S/M xx.xx 081
BTR09-120-MT2	0.472 - 0.590	7.87	4.72	2	BTRW/S/M xx.xx 091,092
BTR10-150-MT3	0.591 - 0.748	9.06	5.91	2	BTRW/S/M xx.xx 101,102,103,104
BTR12-150-MT3	0.748 - 0.984	9.80	5.91	3	BTRW/S/M xx.xx 121,122,123,124

ST SHANK

Diameter
0.236 - 0.984

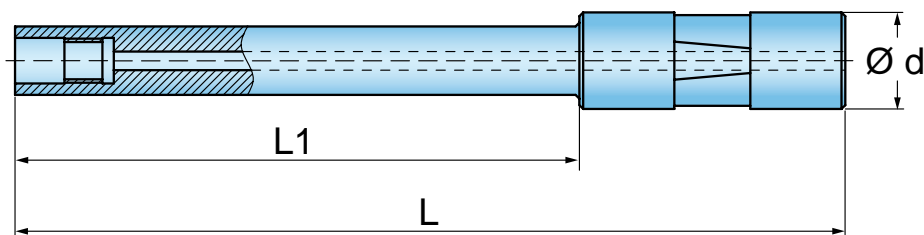

Designation	Diameter	L	L1	d	Corresponding Reaming Head
BTR04-040-ST20	0.236 - 0.305	4.33	1.57	0.787	BTRW/S/M xx.xx 041
BTR05-050-ST20	0.305 - 0.344	4.72	1.97	0.787	BTRW/S/M xx.xx 051
BTR06-050-ST20	0.344 - 0.383	4.72	1.97	0.787	BTRW/S/M xx.xx 061
BTR07-060-ST20	0.384 - 0.433	5.12	2.36	0.787	BTRW/S/M xx.xx 071
BTR08-060-ST20	0.433 - 0.472	5.12	2.36	0.787	BTRW/S/M xx.xx 081
BTR09-060-ST20	0.472 - 0.590	5.12	2.36	0.787	BTRW/S/M xx.xx 091,092
BTR10-080-ST25	0.591 - 0.748	5.91	3.15	0.984	BTRW/S/M xx.xx 101,102,103,104
BTR12-100-ST25	0.748 - 0.984	6.69	3.94	0.984	BTRW/S/M xx.xx 121,122,123,124

SINGLE TUBE SYSTEM - INNER FOUR START THREAD

Drill range
0.496 - 9.606

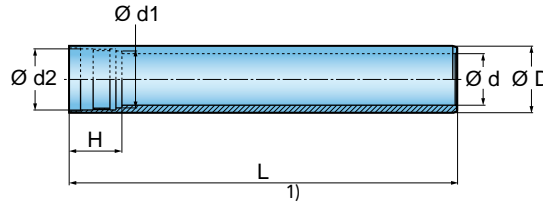

Drill Range	Designation	Dimension					
		D	d	d1	d2	H	S
0.496 - 0.535	BTSI 011 *	0.433	0.276	0.323	0.378	0.87	0.24
0.536 - 0.575	BTSI 012 *	0.472	0.315	0.362	0.417	0.87	0.24
0.575 - 0.614	BTSI 013 *	0.512	0.335	0.402	0.457	0.87	0.24
0.614 - 0.657	BTSI 014	0.551	0.354	0.425	0.496	0.83	0.31
0.658 - 0.697	BTSI 015	0.591	0.394	0.465	0.535	0.83	0.31
0.697 - 0.744	BTSI 016	0.630	0.413	0.492	0.571	0.87	0.31
0.744 - 0.787	BTSI 017	0.669	0.453	0.531	0.610	0.87	0.31
0.788 - 0.858	BTSI 018	0.709	0.472	0.551	0.630	1.08	0.39
0.859 - 0.949	BTSI 020	0.787	0.512	0.630	0.709	1.18	0.47
0.949 - 1.039	BTSI 022	0.866	0.551	0.689	0.768	1.18	0.47
1.040 - 1.130	BTSI 024	0.945	0.610	0.748	0.827	1.18	0.47
1.130 - 1.220	BTSI 026	1.024	0.669	0.827	0.925	1.30	0.63
1.221 - 1.311	BTSI 028	1.102	0.728	0.906	1.004	1.30	0.63
1.311 - 1.425	BTSI 030	1.181	0.787	1.004	1.102	1.30	0.63
1.426 - 1.559	BTSI 033	1.299	0.906	1.063	1.181	1.57	0.79
1.559 - 1.693	BTSI 036	1.417	1.004	1.181	1.299	1.57	0.79
1.693 - 1.850	BTSI 039	1.535	1.102	1.299	1.417	1.57	0.79
1.851 - 2.035	BTSI 043	1.693	1.220	1.417	1.535	1.57	0.79
2.036 - 2.213	BTSI 047	1.850	1.378	1.555	1.693	1.73	0.94
2.213 - 2.386	BTSI 051	2.008	1.535	1.713	1.850	1.73	0.94
2.386 - 2.559	BTSI 056A	2.205	1.693	1.870	2.008	1.73	0.94
2.559 - 2.637	BTSI 056B	2.205	1.693	1.850	2.047	2.95	1.26
2.638 - 2.874	BTSI 062	2.441	1.890	2.087	2.283	2.95	1.26
2.874 - 3.149	BTSI 068	2.677	2.087	2.283	2.480	2.95	1.26
3.150 - 3.425	BTSI 075	2.953	2.323	2.520	2.756	3.82	1.73
3.425 - 3.937	BTSI 082	3.228	2.598	2.795	3.031	3.82	1.73
3.937 - 4.409	BTSI 094	3.701	3.071	3.268	3.504	3.82	1.73
4.409 - 4.881	BTSI 106	4.173	3.543	3.740	3.976	4.65	2.36
4.882 - 5.354	BTSI 118	4.646	3.622	4.213	4.449	4.65	2.36
5.354 - 5.826	BTSI 130	5.118	4.094	4.685	4.921	4.65	2.36
5.827 - 6.299	BTSI 142	5.591	4.567	5.157	5.394	5.47	2.83
6.299 - 6.771	BTSI 154	6.063	5.039	5.630	5.866	5.47	2.83
6.772 - 7.244	BTSI 166	6.535	5.512	6.102	6.339	5.47	2.83
7.244 - 7.716	BTSI 178	7.008	5.984	6.575	6.811	5.67	3.15
7.717 - 8.189	BTSI 190	7.480	6.063	7.047	7.283	5.67	3.15
8.189 - 8.661	BTSI 202	7.953	6.535	7.520	7.756	5.67	3.15
8.661 - 9.133	BTSI 214	8.425	7.008	7.913	8.189	6.46	3.62
9.134 - 9.606	BTSI 226	8.898	7.480	8.386	8.661	6.46	3.62

1) Please indicate overall length (L) when ordering.
* Indicates parts are inner two start thread.

SINGLE TUBE SYSTEM - OUTER SINGLE START THREAD

Drill range
0.571 - 9.685

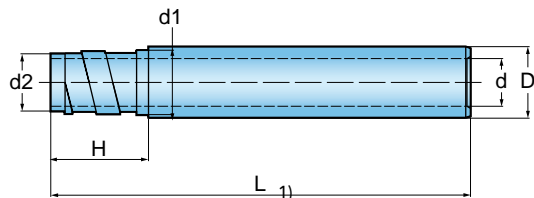

Drill Range	Designation	Dimension					
		D	d	H	d1	d2	S
0.571 - 0.591	BTSE 012A	0.472	0.315	0.91	0.453	0.390	0.24
0.591 - 0.610	BTSE 012B	0.472	0.315	0.91	0.465	0.402	0.24
0.611 - 0.630	BTSE 013A	0.512	0.335	0.91	0.488	0.425	0.24
0.630 - 0.650	BTSE 013B	0.512	0.335	0.91	0.500	0.437	0.24
0.650 - 0.679	BTSE 014A	0.551	0.354	0.91	0.528	0.465	0.24
0.680 - 0.709	BTSE 014B	0.551	0.354	0.91	0.539	0.476	0.24
0.709 - 0.748	BTSE 015	0.591	0.394	0.91	0.567	0.504	0.24
0.748 - 0.787	BTSE 016.5	0.650	0.433	0.91	0.606	0.543	0.24
0.787 - 0.866	BTSE 018	0.709	0.472	1.02	0.650	0.571	0.39
0.866 - 0.984	BTSE 020	0.787	0.512	1.02	0.748	0.630	0.39
0.984 - 1.063	BTSE 022	0.866	0.551	1.02	0.787	0.669	0.39
1.063 - 1.181	BTSE 024	0.945	0.610	1.02	0.866	0.748	0.39
1.181 - 1.259	BTSE 026	1.024	0.669	1.02	0.945	0.827	0.39
1.260 - 1.338	BTSE 028	1.102	0.728	1.02	1.024	0.906	0.39
1.339 - 1.456	BTSE 030	1.181	0.787	1.61	1.063	0.945	0.79
1.457 - 1.574	BTSE 033	1.299	0.906	1.61	1.181	1.063	0.79
1.575 - 1.732	BTSE 036	1.417	1.004	1.61	1.299	1.181	0.79
1.732 - 1.850	BTSE 039	1.535	1.102	1.61	1.457	1.339	0.79
1.850 - 2.047	BTSE 043	1.693	1.220	1.61	1.614	1.457	0.79
2.047 - 2.244	BTSE 047	1.850	1.378	1.61	1.732	1.575	0.79
2.244 - 2.401	BTSE 051	2.008	1.535	1.61	1.929	1.772	0.79
2.402 - 2.677	BTSE 056	2.205	1.693	1.61	2.087	1.929	0.79
2.677 - 2.952	BTSE 062	2.441	1.890	1.61	2.323	2.126	0.79
2.953 - 3.189	BTSE 068	2.677	2.087	2.80	2.559	2.362	1.57
3.189 - 3.582	BTSE 075	2.953	2.323	2.80	2.795	2.598	1.57
3.583 - 3.897	BTSE 082	3.228	2.598	2.80	3.110	2.913	1.57
3.898 - 4.370	BTSE 094	3.701	3.071	2.80	3.543	3.346	1.57
4.370 - 4.842	BTSE 106	4.173	3.543	2.80	4.016	3.819	1.57
4.843 - 5.315	BTSE 118	4.646	4.016	2.80	4.488	4.291	1.57
5.315 - 5.866	BTSE 130	5.118	4.488	2.80	4.961	4.764	1.57
5.866 - 6.378	BTSE 142	5.591	4.961	2.80	5.472	5.276	1.57
6.378 - 6.850	BTSE 154	6.063	5.433	3.39	5.945	5.709	2.20
6.850 - 7.322	BTSE 166	6.535	5.906	3.39	6.417	6.181	2.20
7.323 - 7.795	BTSE 178	7.008	6.378	3.39	6.890	6.654	2.20
7.795 - 8.267	BTSE 190	7.480	6.850	3.39	7.362	7.126	2.20
8.268 - 8.740	BTSE 202	7.953	7.323	3.39	7.835	7.598	2.20
8.740 - 9.212	BTSE 214	8.425	7.795	3.39	8.307	8.071	2.20
9.213 - 9.685	BTSE 226	8.898	8.268	3.39	8.780	8.543	2.20

1) Please indicate overall length (L) when ordering.

SINGLE TUBE SYSTEM - OUTER SINGLE START THREAD

Drill range
0.315 - 0.570

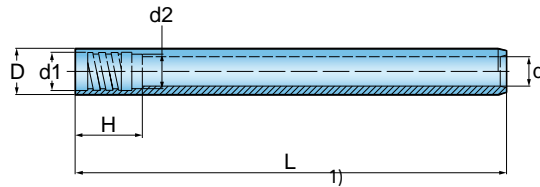

Drill Range	Designation	Dimension					
		D	d	d1	d2	H	S
0.315 - 0.350	BTSO 071	0.280	0.177	0.236	0.213	0.63	0.16
0.354 - 0.393	BTSO 083	0.327	0.197	0.283	0.248	0.63	0.16
0.394 - 0.433	BTSO 090	0.354	0.217	0.299	0.264	0.63	0.16
0.433 - 0.472	BTSO 100	0.394	0.256	0.339	0.303	0.63	0.16
0.472 - 0.531	BTSO 110	0.433	0.276	0.358	0.323	0.63	0.24
0.531 - 0.570	BTSO 120	0.472	0.315	0.425	0.370	0.63	0.24

1) Please indicate overall length (L) when ordering.

DOUBLE TUBE SYSTEM - INNER FOUR START THREAD

Drill range
0.725 - 6.771

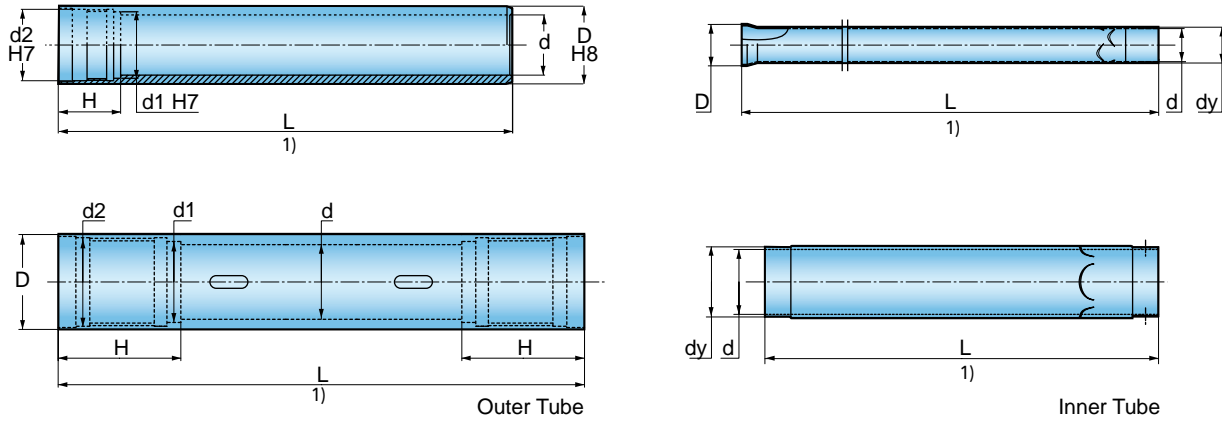

Drill Range	Outer Tube	Dimension						Inner Tube	Dimension		
		D	d	d1	d2	H	S		D	dy	d
0.725 - 0.787	BTDO 018	0.709	0.472	0.551	0.630	1.08	0.39	BTDI 012	0.472	0.394	0.354
0.788 - 0.858	BTDO 019.5	0.768	0.551	0.630	0.709	1.18	0.47	BTDI 014	0.551	0.472	0.433
0.859 - 0.949	BTDO 021.5	0.846	0.591	0.689	0.768	1.18	0.47	BTDI 015	0.591	0.512	0.472
0.949 - 1.039	BTDO 023.5	0.925	0.630	0.748	0.827	1.18	0.47	BTDI 016	0.630	0.551	0.512
1.040 - 1.130	BTDO 026	1.024	0.709	0.827	0.925	1.30	0.63	BTDI 018	0.709	0.630	0.551
1.130 - 1.220	BTDO 028	1.102	0.787	0.906	1.004	1.30	0.63	BTDI 020	0.787	0.709	0.630
1.221 - 1.311	BTDO 030.5	1.201	0.866	1.004	1.102	1.30	0.63	BTDI 022	0.866	0.787	0.709
1.311 - 1.425	BTDO 033	1.299	0.945	1.063	1.181	1.57	0.79	BTDI 024	0.945	0.866	0.787
1.426 - 1.559	BTDO 035.5	1.398	1.024	1.181	1.299	1.57	0.79	BTDI 026	1.024	0.945	0.866
1.559 - 1.693	BTDO 039	1.535	1.142	1.299	1.417	1.57	0.79	BTDI 029	1.142	1.063	0.984
1.693 - 1.850	BTDO 042.5	1.673	1.260	1.417	1.535	1.57	0.79	BTDI 032	1.260	1.181	1.102
1.851 - 2.035	BTDO 046.5	1.831	1.378	1.555	1.693	1.73	0.94	BTDI 035	1.378	1.260	1.181
2.036 - 2.213	BTDO 051	2.008	1.535	1.713	1.850	1.73	0.94	BTDI 039	1.535	1.417	1.339
2.213 - 2.559	BTDO 055.5	2.185	1.693	1.870	2.008	1.73	0.94	BTDI 043A	1.693	1.575	1.496
2.559 - 2.756	BTDO 056	2.205	1.693	1.850	2.047	2.95	1.26	BTDI 043B	-	1.575	1.496
2.756 - 2.874	BTDO 062	2.441	1.890	2.087	2.283	2.95	1.26	BTDI 048	-	1.732	1.614
2.874 - 3.149	BTDO 068	2.677	2.087	2.283	2.480	2.95	1.26	BTDI 053	-	1.890	1.772
3.150 - 3.425	BTDO 075	2.953	2.323	2.520	2.756	3.82	1.73	BTDI 059	-	2.126	1.969
3.425 - 3.937	BTDO 082	3.228	2.598	2.795	3.031	3.82	1.73	BTDI 066	-	2.362	2.205
3.937 - 4.409	BTDO 094	3.701	3.071	3.228	3.504	3.82	1.73	BTDI 078	-	2.756	2.598
4.409 - 4.881	BTDO 106	4.173	3.543	3.740	3.976	4.65	2.36	BTDI 090	-	3.150	2.992
4.882 - 5.354	BTDO 118	4.646	3.622	4.213	4.449	4.65	2.36	BTDI 092	-	3.150	2.992
5.354 - 5.826	BTDO 130	5.118	4.094	4.685	4.921	4.65	2.36	BTDI 104	-	3.740	3.583
5.827 - 6.299	BTDO 142	5.591	4.567	5.157	5.394	5.47	2.83	BTDI 116	-	3.937	3.780
6.299 - 6.771	BTDO 154	6.063	6.220	5.630	5.866	5.47	2.83	BTDI 128	-	4.724	4.567

1) Please indicate overall length(L) when ordering.

*For diameter range 0.725- 2.559 (OT13) the inner tube should be ordered 1.181 longer than the outer tube.

*For diameter range 2.559- 4.881 (OT14 - OT20) the inner tube should be ordered 7.480 longer than outer tube.

*For diameter range 4.882- 7.244 (OT21 - OT25) the inner tube should be ordered 8.661 longer than the outer tube.

ADAPTOR

ADAPTOR TYPE 'S'

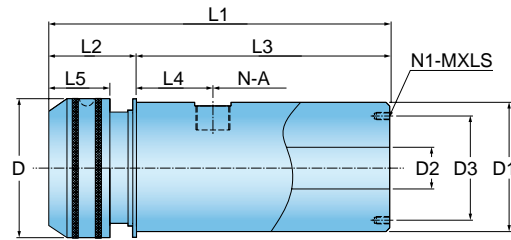

Designation	Drill Dia.	D	D1	D2	D3	L1	L2	L3	L4	L5	N-A	N1-MXLS
DTC-3S	.724-1.039	2.441	2.480	.709	1.969	9.449	1.575	7.874	2.559	1.122	2-PT1/2"	4-M6x11
DTC-4S	.724-2.559	4.409	3.937	1.575	3.150	12.402	2.559	9.843	3.150	1.969	2-PT3/4"	4-M8x15
DTC-5S	2.559-4.878	6.457	5.512	3.189	4.724	4.724	4.528	11.811	5.118	1.850	2-PT1"	6-M8x20

ADAPTOR TYPE 'R'

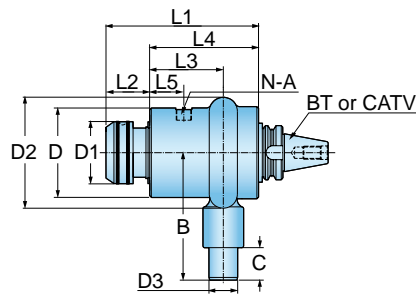

Designation	Drill Dia.	D	D1	D2	D3	B	C	L1	L2	L3	L4	L5	N-A
DTC-3R	.724-1.039	4.331	2.913	5.906	1.575	5.906	1.969	8.976	1.535	5.118	7.441	2.559	2-PT3/4"
DTC-4R	.724-2.559	6.496	4.528	8.110	2.087	7.343	2.362	11.811	2.835	5.984	8.976	2.953	2-PT1"
DTC-5R	2.559-4.878	8.858	6.457	12.283	3.937	12.205	3.937	15.039	2.441	7.913	12.598	3.740	2-PT1 1/4"
DTC-6R	4.882-7.240	12.205	8.425	16.142	5.512	11.811	3.937	16.811	2.441	8.976	14.370	4.055	3-PT1-1/4"

ADAPTOR TYPE 'RF'

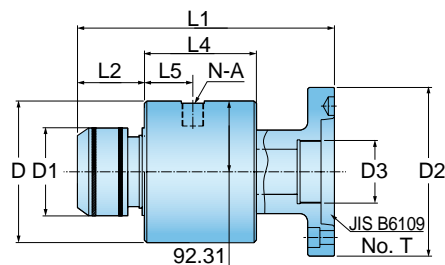

Designation	Drill Dia.	D	D1	D2	D3	L1	L2	L4	L5	N-A	N1-MXLS
DTC-3SRF	.724-1.039	4.331	2.913	5.315	M30x1.5	9.213	1.535	2.559	.709	2-PT3/4"	A1-5
DTC-4RF	.724-2.559	6.496	4.528	8.268	M62x2	11.535	2.835	2.480	1.575	2-PT1"	A1-8
DTC-5RF	2.559-4.878	8.898	6.457	11.024	3.346	13.189	2.441	3.740	3.189	2-PT1 1/4"	A1-11

COLLET

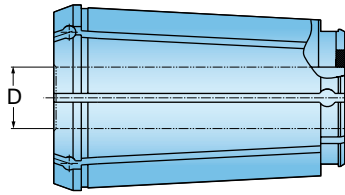

Designation	Drill Dia.	D
COLLET 4-18	.725-.787	.709
COLLET 4-19.5	.788-.858	.768
COLLET 4-21.5	.859-.949	.846
COLLET 4-23.5	.949-1.039	.925
COLLET 4-26	1.040-1.130	1.024
COLLET 4-28	1.130-1.220	1.102
COLLET 4-30.5	1.221-1.311	1.201
COLLET 4-33	1.311-1.425	1.299
COLLET 4-35.5	1.426-1.559	1.398
COLLET 4-39	1.559-1.693	1.535
COLLET 4-42.5	1.693-1.850	1.673
COLLET 4-46.5	1.851-2.035	1.831
COLLET 4-51	2.036-2.213	2.008
COLLET 4-55.5	2.213-2.559	2.185

SEALING SLEEVE

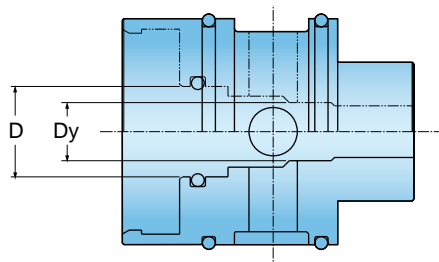

Designation	Drill Dia.	D	Dy	Outer O-ring	Inner O-ring
SEALING SLEEVE 4-18	.725-.787	.709	.394	OOR 65	IOR 18
SEALING SLEEVE 4-19.5	.788-.858	.768	.472		IOR 19.5
SEALING SLEEVE 4-21.5	.859-.949	.846	.512		IOR 21.5
SEALING SLEEVE 4-23.5	.949-1.039	.925	.551		IOR 23.5
SEALING SLEEVE 4-26	1.040-1.130	1.024	.630		IOR 26
SEALING SLEEVE 4-28	1.130-1.220	1.102	.709		IOR 28
SEALING SLEEVE 4-30.5	1.221-1.311	1.201	.787		IOR 30.5
SEALING SLEEVE 4-33	1.311-1.425	1.299	.866		IOR 33
SEALING SLEEVE 4-35.5	1.426-1.559	1.398	.945		IOR 35.5
SEALING SLEEVE 4-39	1.559-1.693	1.535	1.063		IOR 39
SEALING SLEEVE 4-42.5	1.693-1.850	1.673	1.181		IOR 42.5
SEALING SLEEVE 4-46.5	1.851-2.035	1.831	1.260		IOR 46.5
SEALING SLEEVE 4-51	2.036-2.213	2.008	1.417		IOR 51
SEALING SLEEVE 4-55.5	2.213-2.559	2.185	1.575		IOR 55.5

DEEP HOLE DRILLING QUESTIONNAIRE

Company Name _____ Inquiry Number _____
 Address _____ Inquiry Date _____
 Contact person _____ Customer No _____

WORKPIECE

(If possible, please attach a drawing)

Product Name	
Hole diameter (ø)	(in)
Hole depth (drilling length)	(in)
No. of holes	
Tolerance (of hole)	
Surface finish (Rz,Ra...)	
Deviation (mm/100)	
Straightness (mm/100)	
Material	
Material (DIN,AISI,JIS...)	
Hardness (HB,HS,HRC...)	
Condition *	<input type="checkbox"/> Annealed <input type="checkbox"/> Quenched <input type="checkbox"/> Tempered
	<input type="checkbox"/> Cast <input type="checkbox"/>
	<input type="checkbox"/> Other <input type="checkbox"/>

MACHINE

Machine supplier name	
Machine type/model	
Rigidity	<input type="checkbox"/> Good <input type="checkbox"/> Normal <input type="checkbox"/> Bad
Date of manufacture	
Retrofitted	<input type="checkbox"/> NC lathe <input type="checkbox"/> M/C <input type="checkbox"/> Other
Double rotation(TR WR)	<input type="checkbox"/> Tool and Workpiece
Rotating workpiece(WR)	<input type="checkbox"/>
Rotating tool(TR)	<input type="checkbox"/>
Safety devices	
Motors power	

TYPE OF COOLANT

Coolant supplier name	
Water based	<input type="checkbox"/> Soluble <input type="checkbox"/> Emulsion %
Oil based	<input type="checkbox"/>
Coolant Pressure	
Coolant Volume	

TOOL

Drill Head

Drill diameter(ø)	(in)
Thread	<input type="checkbox"/> Inner <input type="checkbox"/> Outer
Brazed	<input type="checkbox"/>
Indexable	<input type="checkbox"/> Adjustable <input type="checkbox"/> Direct mount
Coating	<input type="checkbox"/> Coated <input type="checkbox"/> Uncoated
Coating type	<input type="checkbox"/> TiN <input type="checkbox"/> TiAlN <input type="checkbox"/> Other
• Solid drilling	<input type="checkbox"/>
• Counterboring	<input type="checkbox"/>
Cutting brazed	<input type="checkbox"/> 20° <input type="checkbox"/> 45° <input type="checkbox"/>
angle* indexable	<input type="checkbox"/> normal angle <input type="checkbox"/> close angle
Pre-bored size(per side)	(in)
Bottom finishing *	<input type="checkbox"/> Fullball R <input type="checkbox"/> Flatbottom R <input type="checkbox"/> Corner R
	<input type="checkbox"/> Compound R
• Trepanning	<input type="checkbox"/>
Core size(ø)	(in) <input type="checkbox"/>
Tube inner dia(ø)	(in)
Tube outer dia(ø)	(in)

Tube

Outside Dia(ø)	(in)
Total Length(L)	(in)
Internal Thread	
External Thread	<input type="checkbox"/> 4 Starts <input type="checkbox"/> 2 Starts <input type="checkbox"/> 1 Start
Tube thread	<input type="checkbox"/> 1 end <input type="checkbox"/> Both ends
Inner Tube Length	(in)
Inner Tube Slit	<input type="checkbox"/> 1 End <input type="checkbox"/> Both ends

DRILLING SYSTEM

Single tube system	<input type="checkbox"/> STS
Double tube system	<input type="checkbox"/> DTS

BORING CONDITIONS

Through hole drilling	<input type="checkbox"/>
Blind hole drilling	<input type="checkbox"/>
Cross hole drilling*	<input type="checkbox"/>

GENERAL INFORMATION

Production

Quantity per year:	
Present Performance Status:	
grade, tool life, etc:	
Cutting Data:	Vc= SFM, N= rpm
	f= in/re, F= in/min



Ingersoll



■ **GRADE DESCRIPTIONS**

[PAGE 668](#)

■ **CARBIDE SELECTION GUIDE**

[PAGE 669](#)

■ **WORKPIECE MATERIAL DATA**

[PAGE 670](#)

■ ***SPOTON*™ GUIDELINES**

[PAGE 673](#)

■ ***DRILLON*™ SOLID CARBIDE GUIDELINES**

[PAGE 676](#)

■ ***QWIKTWIST*™ GUIDELINES**

[PAGE 677](#)

TECHNICAL INFORMATION.

Cutting Tools

- **QWIK®TWIST™** CHAMFER RINGS

PAGE 682

- **QWIK®TWIST™** SLIP-FIT

PAGE 684

- **QUAD®DRILL™** GUIDELINES

PAGE 685

- **QUAD®BORE™** GUIDELINES

PAGE 691

- **QWIK®REAM™** GUIDELINES

PAGE 694

- **RAPID®THREAD™** GUIDELINES

PAGE 700

- **DEEP HOLE DRILLING GUIDELINES**

PAGE 705

STANDARD GRADE DESCRIPTIONS

	Grade Number	Industry Class	ISO Rating	Coating	Workpiece Materials
UNC (Uncoated)	IN10K	C3	K5-K15	None	Aluminum, non-ferrous materials
	IN30M	C-1/C-2	K20-K50 M20-M40	None	Cast iron, aluminum, non-ferrous materials, high-temp alloys
	IN40P	C-5/C-6	P20-P35	None	Steels
CVD (Chemical Vapor Deposition)	IN6515	C-1/C-3 C-5/C-7	K15-K35 P20-P30	MT-CVD Al2O3	Cast iron, steels
	IN6520	C-3/ C-5	K20-K40 M10-M30 P20-P35 S15-S25	MT-CVD TiCN TiN Al2O3	Cast iron, steels, stainless, high abrasive materials, *peripheral/outboard pocket only
	IN6530	C-2/C-1 C-5/C-6	K20-K50 M25-M40 P25-P45	MT-CVD Al2O3	Cast iron, steels, stainless, high-temp alloys
PVD (Physical Vapor Deposition)	IN1030	C-1/C-2	K20-K30 M20-M40	PVD TiCN	Cast iron, aluminum, stainless, titanium
	IN1040	C-5/C-7	P20-P40	PVD TiCN	Steels, stainless
	IN1505	C-1/C-7	P10-P30 M10-M30	TiCN-TiN	Cast iron, steels, stainless, high-temp alloys
	IN1530	C-1/C-5	K25-K40 M30-M40	PVD TiCN-TiN	Steels, stainless, titanium, high-temp alloys
	IN2005	C-1/C-8	K50-P01	PVD TiAlN	Cast iron, steels, stainless, high-temp alloys
	IN2010	C-1/C-3	K10-K30	PVD TiAlN	Cast iron
	IN2030	C-1/C-5	K25-K40 M30-M40	TiAlN	Cast iron, steels, stainless, high-temp alloys

GUIDE

Direction of Use	Wear Resistance →										Wear Resistance →					Wear Resistance →																					
	← Toughness										← Toughness					← Toughness																					
	← Increase Feed										← Increase Feed					← Increase Feed																					
	Increase Speed →										Increase Speed →					Increase Speed →																					
Material	Short Chipping Malleable Iron, Non-Ferrous Metal, Hardened Iron, Chilled Iron, Cast Iron										High-Temp Alloys, Alloy Iron, Steel Casting, Manganese					Free Cutting Steels, Malleable Iron, Steel Casting, Steel																					
Grade	Coating	C1					C2		C3		C4											C5			C6		C7		C8								
		K50	K45	K40	K35	K30	K25	K20	K15	K10	K05	K01	M50	M40	M30	M20	M10	P50	P45	P40	P35	P30	P25	P20	P15	P10	P05	P01									
IN10K	Uncoated											IN10K																									
IN30M																																					
IN40P																																					
IN6515	CVD																																				
IN6520																																					
IN6530																																					
IN1030	PVD																																				
IN1040																																					
IN1505																																					
IN1530																																					
IN2005																																					
IN2010																																					
IN2030																																					

INGERSOLL ISO MATERIAL GROUPS

ISO	Material	Condition	Tensile Strength (Kpsi)	Hardness HB	Material Number	
P	Non - Alloy Steels	<0.25% C	Annealed	61	125	1
	Steel Castings	=>0.25% C	Annealed	94	190	2
	Free Machining Steel	<0.55% C	Quenched & Tempered	123	250	3
			Annealed	109	220	4
			Quenched & Tempered	145	300	5
	Low - Alloy Steels and Steel Castings (less than 5% of alloying elements)		Annealed	87	200	6
			Quenched & Tempered	135	275	7
				145	300	8
				174	350	9
	High - Alloy Steels, Steel Castings & Tool Steels		Annealed	99	200	10
			Quenched & Tempered	160	325	11
M	Stainless Steels and Stainless Steel Castings	Ferritic/Martensitic	99	200	12	
		Martensitic	119	240	13	
		Austenitic & P.H.	87	180	14	
K	Nodular Cast Iron (GGG)	Ferritic / Pearlitic		180	15	
		Pearlitic		260	16	
	Grey Cast Iron (GG)	Ferritic		160	17	
		Pearlitic		250	18	
	Malleable Cast Iron	Ferritic		130	19	
Pearlitic		230	20			
N	Aluminum wrought alloy	As cast		60	21	
		Forged		100	22	
	Cast Aluminum alloyed	<=12% Si	As cast		75	23
			Forged		90	24
		> 12% Si	High Temperature		130	25
			Free Cutting		110	26
	Copper Alloys		Brass		90	27
			Electrolitic Copper		100	28
			Duroplastics & Fiberplastics			29
	Non Metallic		Hard Rubber			30
S	High Temp Alloys	Fe Based	Annealed		200	31
			Cured		280	32
		Ni or Co Based	Annealed		250	33
			Cured		350	34
			Cast		320	35
	Titanium and Ti Alloys		58		36	
		Alpha + Beta alloys cured	152		37	
H	Hardened Steel			55 HRc	38	
				60 HRc	39	
	Chilled Cast Iron	Cast		400	40	
	Cast Iron	Hardened		55 HRc	41	

●=P ●=M ●=K ●=N ●=S ○=H

INGERSOLL MATERIAL GROUPS

Material Group	AISI/SAE Material Spec	DIN Material Spec
1	1010	Ck10
1	1025	C25E, Ck25
1	1213	9SMn28
1	1215	9SMn36
1	1015, 1017	CK15
1	1016	C15
1	1020, 1023	C22
1	1022, 1518	20Mn5
1	11 L 08	10SPb20
1	12 L 13	9SMnPb28
1	12 L 14	9SMnPb36
1	A27 65-35	GS-45
2	1035	C35, Cf35
2	1039	40Mn4
2	1040	C40
2	1042	Ck45
2	1043, 1045	C45
2	1050	Cf53
2	1140	35S20
2	1146	45S20
2	A148 80 40	GS-60
2	A27 70-36	GS-52
2	A537 1	19Mn6
2	A662 C	Ast45
2	A738	Ast52
2	1335	36Mn5
2	1330	28Mn6
4	1055	C55, Ck55
4	1060	C60
4	1064	Ck60
4	1070	Ck67
4	1080	Ck75
4	1095	Ck101
4	W110	C105W1
4	9255	55Si7
6	1006	St36
6	A515 65	H1
6	A573 81	St44-3
6	A573 81 65	St37-3
6	8620, 8617	21NiCrMo2
6	8740, 8640, 8742	40NiCrMo22
6	4317	17CrNiMo6
6	5015	15Cr3
6	5132	34Cr4
6	5140	41Cr4
6	5155	55Cr3
6	5120	St52-3
6	9262	1.0961

Material Group	AISI/SAE Material Spec	DIN Material Spec
6	4520	16Mo5
6	ASTM A350LF5	14Ni6
6	L1	34MoCrS4G
6	5140	42Cr4
6	5115	16MnCr5
6		14MoV6 3
6		31CeMo12
6		39CrMoV13 9
6-7	4130	25CrMo4
6-7	4135, 4137	34CrMo4
6-7	4142	41CrMo4
6-7	4140	42CrMo4
6-9	L3	100Cr6
6-9		105WCr6
6-9	L6	55NiCrMoV6
6-9	L6	50NiCr13
6-9	9840	36CrNiMo4
6-9	6150	50CrV4
6-9	ASTM A290	41CrAlMo7
7		15CrMo5
7	A570-36	RS37-2
7	4340	35CrNiMo6
9	52100	100Cr6
9	ASTM A204 Gr. A	15Mo3
9	3135	36NiCr6
9	3415	14NiCr10
9	3310	14NiCr14
9	ASTM A182 F-12	13CrMo44
9	ASTM A387 12-2	16CrMo44
9		32CrMo12
10	ASM A353	X8Ni9
10	2515, 2517	12Ni19
10	9310	14NiCrMo13-4
10	D3	X210Cr12
10		X42Cr13
10	H13	X40CrMoV51
10	A2	X100CrMoV51
10	S1	45WCrV7
10	H21	X30WCrV93
10		X165CrMoV12
10	M35	S6/5/2/5
10	M2	S6/5/2
10	M7	S2/9/2
10	HW3	X45CrSi93
11	D2	X155CrVMo121
11	D4, D6	X210CrW12
11	630	1.4542/1.4548
12	430F	X12CrMoS17

INGERSOLL MATERIAL GROUPS

Material Group	AISI/SAE Material Spec	DIN Material Spec
12		X5CrNi134
12	430	X10CrA118
12	405	X10CrA113
12	434	X6CrMo17
12	HNV6	X80CrNiSi20
12	446	X10CrA124
12	EV8	X53CrMnNiN219
12	S32900	X8CrNiMo
12	440B	X90CrMoV18
12		X46Cr13
12	403	X7Cr13
12	410	X10Cr13
12	420	1.4021
12	431	X22CrNi17
13	ASTM A128 75	G-X120Mn12
14	303	X12CrNiS188
14	304L	X2CrNi189
14	304	X5CrNi189
14	301	X12CrNi177
14	304LN	X4CrNiN1810
14	316	X5CrNiMo1810
14	316LN	X2CrNiMoN1813
14	316L	X2CrNiMo1812
14	317L	X2CrNiMo1816
14	S32304	X2CrNi234
14	S31803	X2CrNiMoN2253
14	321	X10CrNiTi189
14	347	X10CrNiNb
14	316Ti	X10CrNiMoTi18
14	318	X10CrNiMoNb18
14	309	X15CrNiSi2012
14	310S	X12CrNi2521
14	S31254	
14	17-7PH	1.4568/1.4504
15		GGG 35.3
15	60-40-18	GGG 40
15		GGG 40.3
15	80-55-06	GGG 50
16		GGG 60
16	100-70-03	GGG 70
17	A48 20B	GG 10
17	A48 25B	GG15
17	A48 30B	GG 20
18	A48 40B	
18	A48 35B	GG 25
18	A48 45B	GG 30
18	A48 50B	GG 35
18	A48 60B	GG 40

Material Group	AISI/SAE Material Spec	DIN Material Spec
19	32510	GTS-35
20	40010	GTS-45
20	50005	GTS-55
20	70003	GTS-65
23-24	A356-72	
23-24	356.1	
23-24	A360.2	G-ALSi10Mg
23-24	A413.2	G-ALSi12
23-24	A413.1	G-ALSi12(Cu)
23-24	A413.0	GD-ALSi12
23-24	A380.1	GD-ALSi8Cu3
31	330	X12NiCrSi
31		G-X40NiCrSi
33	5390A	2.4603
33		NiCr20Ti
33	5666	NiCr22Mo9N
34	5537C	CoCr20W15
34	4676	NiCu30Al
34		NiCr20TiAk
34	AMS 5399	NiCr19Co11
34	5391	S-NiCr13A16
34	5660	NiFe35Cr14
34	5383	NiCr19Fe19
34	AMS 5544	NiCr19Fe19
34	AMS 5772	CoCr22W14
35	AMS 5397	NiCo15Cr10
37		TiAl4Mo4Sn4Si0.5
37	AMS R54520	TiAl5Sn2.5
37	AMS R56400	TiAl6V4
37	AMS R56401	TiAl6V4ELI

SERIES "FAK" DRILL

ISO	Material Number	Cutting Speed (SFM)	Feed (in./rev.) ø.189-ø.292
P	1	450 - 550	.001" - .003"
	2	450 - 550	.001" - .003"
	3	450 - 550	.001" - .003"
	4	450 - 550	.001" - .003"
	5	450 - 550	.001" - .003"
	6	450 - 550	.001" - .003"
	7	450 - 550	.001" - .003"
	8	450 - 550	.001" - .003"
	9	450 - 550	.001" - .003"
	10	450 - 550	.001" - .003"
	11	450 - 550	.001" - .003"
M	12	400 - 500	.001" - .003"
	13	300 - 400	.001" - .003"
	14	400 - 500	.001" - .003"
K	15	300 - 400	.002" - .004"
	16	300 - 400	.002" - .004"
	17	450 - 550	.002" - .004"
	18	450 - 550	.002" - .004"
	19	450 - 550	.002" - .004"
	20	450 - 550	.002" - .004"
N	21	1500 - 3000	.002" - .004"
	22	1500 - 3000	.002" - .004"
	23	1500 - 3000	.002" - .004"
	24	1500 - 3000	.002" - .004"
	25	1500 - 3000	.002" - .004"
	26	1500 - 3000	.002" - .004"
	27	1500 - 3000	.002" - .004"
	28	1500 - 3000	.002" - .004"
	29		
	30		
S	31	100 - 200	.001" - .003"
	32	100 - 200	.001" - .003"
	33	100 - 200	.001" - .003"
	34	100 - 200	.001" - .003"
	35	100 - 200	.001" - .003"
	36	130 - 230	.001" - .003"
	37	130 - 230	.001" - .003"
H	38	50 - 100	.001" - .003"
	39	50 - 100	.001" - .003"
	40	50 - 100	.001" - .003"
	41	50 - 100	.001" - .003"

SERIES "Y" (SPOT IN) DRILL

ISO	Material Number	Cutting Speed (SFM)	Feed (in./rev.) ø.189-ø.292
P	1	260 - 430	.006" - .010"
	2	260 - 430	.006" - .010"
	3	230 - 390	.006" - .010"
	4	230 - 390	.006" - .010"
	5	230 - 390	.006" - .010"
	6	130 - 430	.006" - .010"
	7	130 - 430	.006" - .010"
	8	130 - 430	.006" - .010"
	9	130 - 430	.006" - .010"
	10	130 - 260	.005" - .008"
	11	130 - 260	.005" - .008"
M	12	70 - 160	.004" - .006"
	13	70 - 160	.004" - .006"
	14	70 - 160	.004" - .006"
K	15	260 - 460	.010" - .014"
	16	260 - 460	.010" - .014"
	17	300 - 590	.010" - .014"
	18	300 - 590	.010" - .014"
	19	300 - 590	.010" - .014"
	20	300 - 590	.010" - .014"
N	21	260 - 520	.010" - .014"
	22	260 - 520	.010" - .014"
	23	260 - 520	.010" - .014"
	24	260 - 520	.010" - .014"
	25	260 - 520	.010" - .014"
	26	260 - 520	.010" - .014"
	27	260 - 520	.010" - .014"
	28	260 - 520	.010" - .014"
	29		
	30		
S	31	70 - 160	.003" - .005"
	32	70 - 160	.003" - .005"
	33	70 - 160	.003" - .005"
	34	70 - 160	.003" - .005"
	35	70 - 160	.003" - .005"
	36	70 - 160	.004" - .006"
	37	70 - 160	.004" - .006"
H	38	70 - 160	.004" - .006"
	39	70 - 160	.004" - .006"
	40	70 - 160	.004" - .006"
	41	70 - 160	.004" - .006"

○=P ●=M ●=K ●=N ●=S ○=H

Z-Axis DOC to Spot Diameter Chart (FAK)

α Included Angle	D Spot Diameter												
	.060	.090	.120	.150	.210	.270	.330	.390	.480	.570	.660	.750	
82°	.035	.052	.069	.086	.121	.155	.190	.224	.276	.328	.380	.431	-
90°	.030	.045	.060	.075	.105	.135	.165	.195	.240	.285	.330	.375	.420
118°	.018	.027	.036	.045	.063	.081	.099	.117	.144	.171	.198	-	-
135°	.012	.019	.025	.031	.043	.056	.068	.081	.099	.118	.137	-	-
144°	.010	.015	.019	.024	.034	.044	.054	.063	.078	.093	.107	-	-

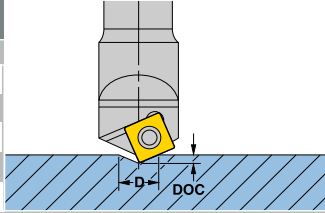

*Z-axis DOC is measured to theoretical sharp corner.

Z-Axis DOC to Spot Diameter Chart (SPOT IN)

D ₁ Cutter Dia.		α Included Angle	D ₂ Spot Diameter											
inch	mm		.060	.090	.120	.150	.200	.250	.310	.380	.470	.500	.560	.360
.630	16,0	90°	.030	.045	.060	.075	.100	.125	.155	.190	.235	.250	.280	.315
.630	16,0	140°	.011	.016	.022	.027	.036	.045	.056	.069	.086	.091	.102	.115
.472	12,0	90°	.030	.045	.060	.075	.100	.125	.155	.190	.235	-	-	-
.472	12,0	140°	.011	.016	.022	.027	.036	.045	.056	.069	.086	-	-	-

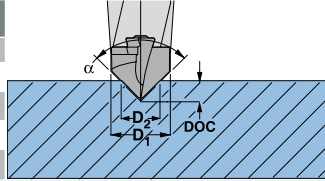

*Z-axis DOC is measured to theoretical sharp corner.

Insert Loading:



Insert loading is easy and fast. Simply insert the drill point into the special dovetail bayonet pocket. Then turn it to the locked position using the proper clamping wrench provided with each drill body.

SPOTTING DRILL RECOMMENDATIONS

SPOTTING DRILL RECOMMENDATIONS FOR SOLID CARBIDE AND QWIK TWIST DRILLS

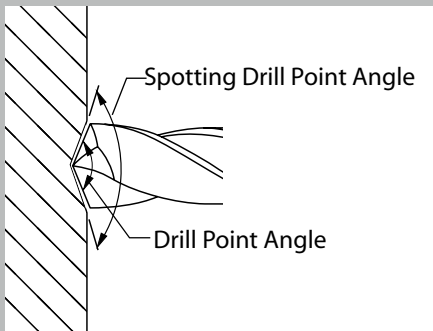

BEST

Spotting drill angle is greater than the drill point angle.

- First contact is at the drill point.
- Best drill centering possibility.
- Drill loading increases with penetration.

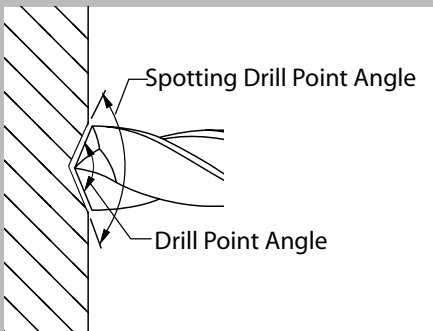

ACCEPTABLE

Spotting drill angle is the same as the drill point angle.

- Tool loading problems can occur due to immediate full engagement.
- Chatter may be a problem.
- Reduced feed at entry recommended.
- Good drill centering.

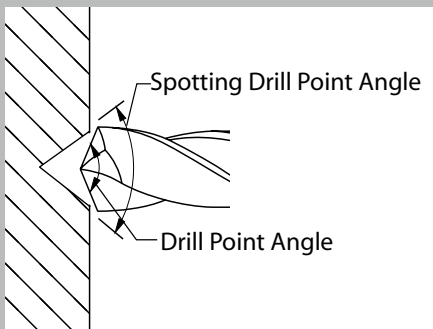

NOT RECOMMENDED WITH CARBIDE

Spotting drill angle is less than the drill point angle.

- Point contact along cutting lips or corner - drill point should contact spotted hole first..
- Chipping likely in these areas.

DRILLOIN™ DR SOLID CARBIDE DRILLS OPERATING GUIDELINES

ISO	Material Number	Cutting Speed (SFM)	Feed (in/rev) ϕ .118 - ϕ .185	Feed (in/rev) ϕ .189 - ϕ .292	Feed (in/rev) ϕ .295 - ϕ .396	Feed (in/rev) ϕ .397 - ϕ .500
P	1	250 - 450	.002" - .006"	.003" - .007"	.005" - .010"	.006" - .012"
	2	250 - 450	.002" - .006"	.003" - .007"	.005" - .010"	.006" - .012"
	3	150 - 400	.002" - .004"	.003" - .005"	.005" - .008"	.006" - .010"
	4	150 - 400	.002" - .004"	.003" - .005"	.005" - .008"	.006" - .010"
	5	150 - 400	.002" - .004"	.003" - .005"	.005" - .008"	.006" - .010"
	6	120 - 250	.002" - .004"	.002" - .005"	.004" - .007"	.005" - .009"
	7	120 - 250	.002" - .004"	.002" - .005"	.004" - .007"	.005" - .009"
	8	120 - 250	.002" - .004"	.002" - .005"	.004" - .007"	.005" - .009"
	9	120 - 250	.002" - .004"	.002" - .005"	.004" - .007"	.005" - .009"
	10	100 - 240	.002" - .004"	.002" - .004"	.004" - .006"	.005" - .009"
	11	100 - 240	.002" - .004"	.002" - .004"	.004" - .006"	.005" - .009"
M	12	190 - 230	.002" - .004"	.002" - .004"	.003" - .006"	.005" - .008"
	13	160 - 200	.002" - .004"	.002" - .005"	.004" - .007"	.006" - .009"
	14	110 - 200	.002" - .004"	.002" - .004"	.003" - .006"	.005" - .008"
K	15	230 - 300	.005" - .008"	.007" - .011"	.009" - .015"	.012" - .020"
	16	230 - 300	.005" - .008"	.007" - .011"	.009" - .015"	.012" - .020"
	17	260 - 330	.006" - .010"	.008" - .013"	.011" - .017"	.013" - .024"
	18	260 - 330	.006" - .010"	.008" - .013"	.011" - .017"	.013" - .024"
	19	260 - 330	.006" - .010"	.008" - .013"	.011" - .017"	.013" - .024"
	20	260 - 330	.006" - .010"	.008" - .013"	.011" - .017"	.013" - .024"
N	21	300 - 400	.004" - .010"	.007" - .014"	.009" - .017"	.012" - .020"
	22	300 - 400	.004" - .010"	.007" - .014"	.009" - .017"	.012" - .020"
	23	300 - 400	.004" - .010"	.007" - .014"	.009" - .017"	.012" - .020"
	24	300 - 400	.004" - .010"	.007" - .014"	.009" - .017"	.012" - .020"
	25	300 - 400	.004" - .010"	.007" - .014"	.009" - .017"	.012" - .020"
	26	300 - 400	.003" - .007"	.007" - .014"	.009" - .017"	.012" - .020"
	27	300 - 400	.003" - .007"	.007" - .014"	.009" - .017"	.012" - .020"
	28	300 - 400	.003" - .007"	.007" - .014"	.009" - .017"	.012" - .020"
	29					
	30					
S	31	30 - 80	.001" - .003"	.002" - .003"	.003" - .004"	.004" - .005"
	32	30 - 80	.001" - .003"	.002" - .003"	.003" - .004"	.004" - .005"
	33	30 - 80	.001" - .003"	.002" - .003"	.003" - .004"	.004" - .005"
	34	30 - 80	.001" - .003"	.002" - .003"	.003" - .004"	.004" - .005"
	35	30 - 80	.001" - .003"	.002" - .003"	.003" - .004"	.004" - .005"
	36	70 - 140	.001" - .003"	.002" - .004"	.003" - .006"	.004" - .008"
	37	70 - 140	.001" - .003"	.002" - .004"	.003" - .006"	.004" - .008"
H	38	50 - 100	.001" - .002"	.001" - .003"	.001" - .003"	.002" - .004"
	39	50 - 100	.001" - .002"	.001" - .003"	.001" - .003"	.002" - .004"
	40	50 - 100	.001" - .002"	.001" - .003"	.001" - .003"	.002" - .004"
	41	50 - 100	.001" - .002"	.001" - .003"	.001" - .003"	.002" - .004"

● = P ● = M ● = K ● = N ● = S ○ = H

ISO	Material Number	Cutting Speed Vc sfm	Feed vs. Drill Diameter ipr											
			D=.268-.429	D=.433-.508	D=.512-.587	D=.591-.665	D=.669-.823	D=.827-1.020						
P	1	160-430	.005-.008	.006-.010	.008-.012	.010-.014	.010-.018	.010-.018						
	2	330-390												
	3	300-360												
	4	300-390												
	5	230-300												
	6	160-360	.005-.008	.006-.010	.008-.012	.010-.014	.012-.016	.012-.018						
	7	230-360												
	8	200-300												
	9	130-230												
	10	160-260	.005-.008	.005-.009	.006-.010	.008-.011	.010-.013	.010-.014						
	11	130-230												
M	12	70-160	.003-.006	.005-.009	.005-.006	.006-.008	.006-.009	.006-.011						
	13													
	14													
K	15	300-460	.008-.012	.010-.014	.012-.016	.014-.018	.016-.020	.016-.024						
	16	260-430												
	17	330-590												
	18	300-520												
	19													
	20													
21														
N	22	300-520	.008-.014	.010-.016	.012-.018	.014-.018	.016-.024	.016-.026						
	23													
	24													
	25								260-390					
	26	300-520												
	27													
	28													
	29													
	30													
	S	31							100-160	.002-.004	.003-.005	.004-.006	.005-.007	.005-.008
32														
33		70-130												
34														
35														
36		70-160	.002-.005	.004-.006	.005-.007	.006-.008	.006-.009	.006-.010						
37														
H	38	70-160							.002-.005	.004-.006	.005-.007	.006-.008	.006-.009	.006-.010
	39													
	40													
	41													

DRILL POINT REPLACEMENT INDICATIONS

1. Limit cutting edge wear to .008" to .012".
(see Fig. 1)
2. Power consumption exceeds 125% of normal.
(see Fig. 2)
3. Drilled hole diameter variation.
(see Fig. 3)
4. Deterioration of surface finish of the drilled hole.
(see Fig. 4)
5. Significant increase in noise or vibration.
(see Fig. 5)

Fig. 1: Wear Limit

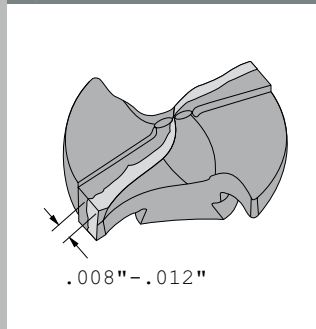

Fig. 2: Power Restriction

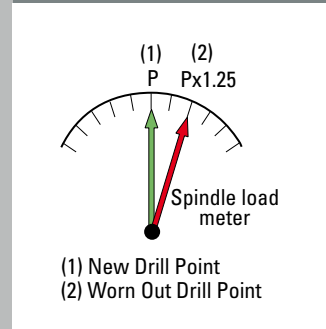

Fig. 3: Diameter Change

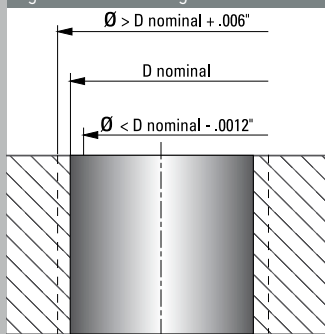

Fig. 4: Surface Finish Decline

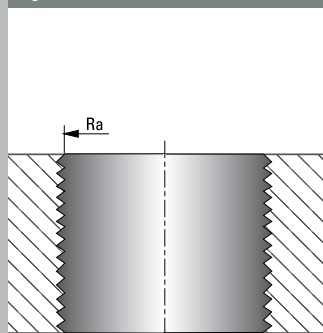
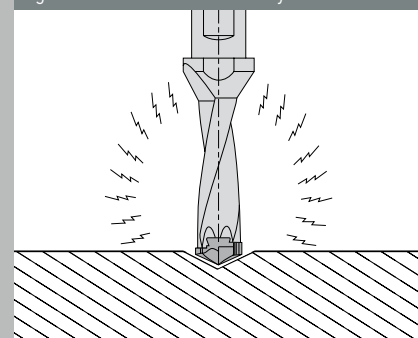
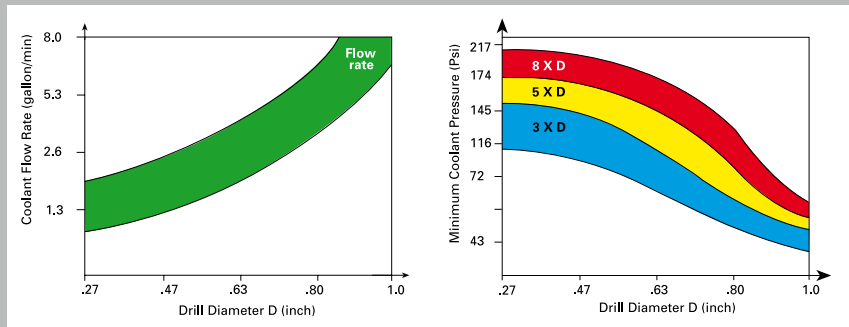

Fig. 5: Noise or vibration drastically increases



RECOMMENDED COOLANT PRESSURE AND FLOW RATE



For proper chip evacuation, the coolant must flow through the tool. If the machine is not equipped with coolant through the spindle, we recommend using a coolant inducer. External coolant supply can be used if the hole depth is less than 1xD and reduced cutting parameters are applied.

Coolant Mix

Recommended coolant concentration is 6% to 8%. When drilling stainless and high strength steels, a 10% concentration is recommended.

Dry Drilling

It is possible to drill without coolant in cast iron. oil mist through the drill is required (2xD max hole depth).

COOLANT

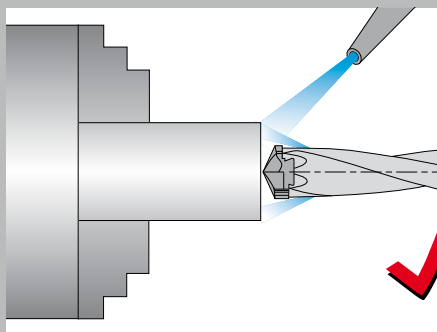
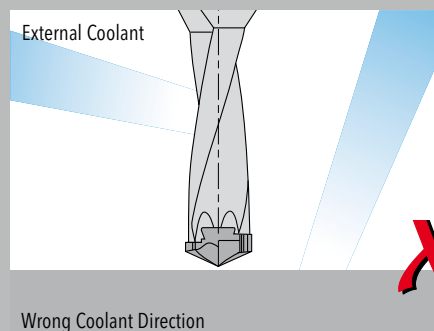
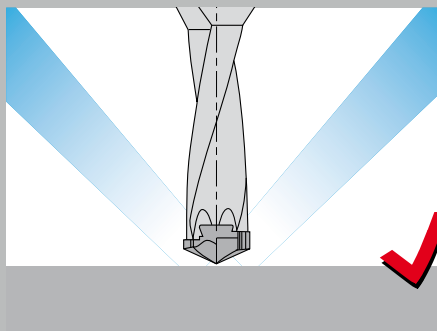
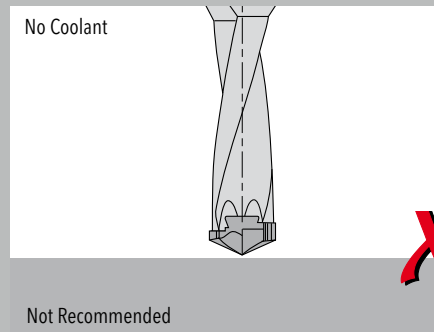
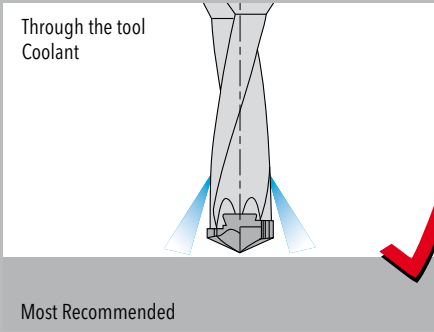

In stationary drill applications both through the tool and external coolant is recommended.

DRILLING LIMITATIONS

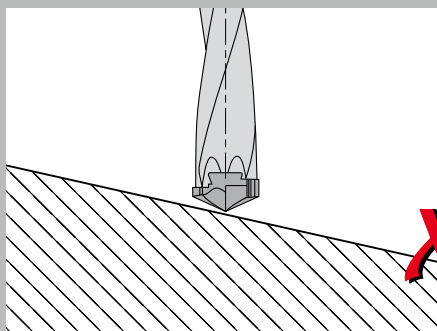

Angular or Irregular Surfaces (Maximum 6° angle)

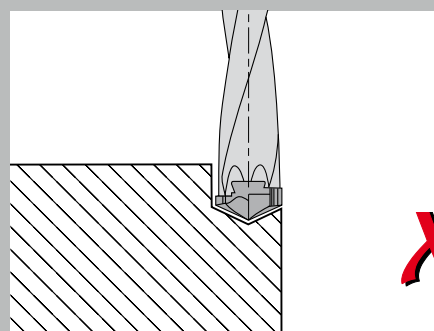

Interrupted or Partial Holes

MOUNTING A DRILL POINT

Fig. 1

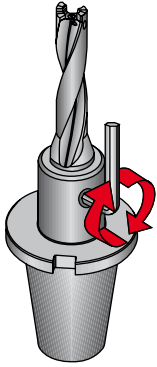

Fig. 2

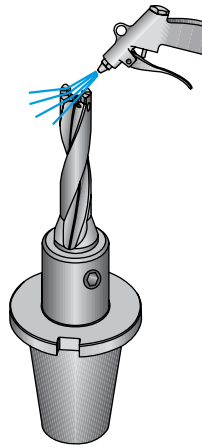

Fig. 3

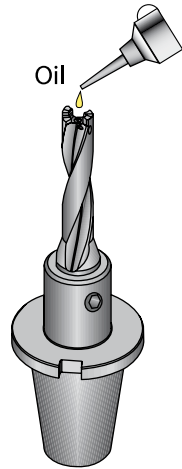

Fig. 4

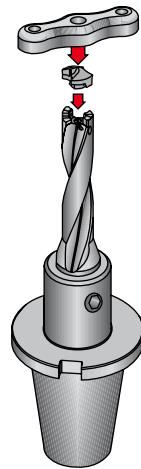
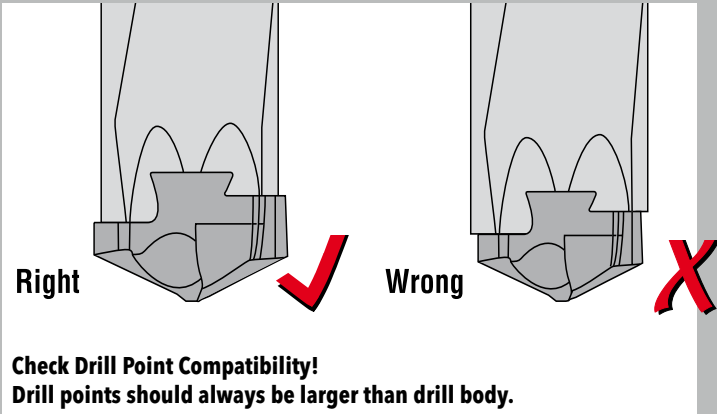
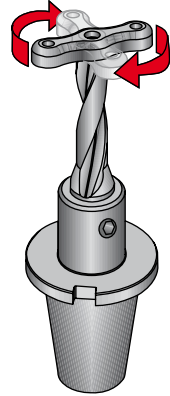
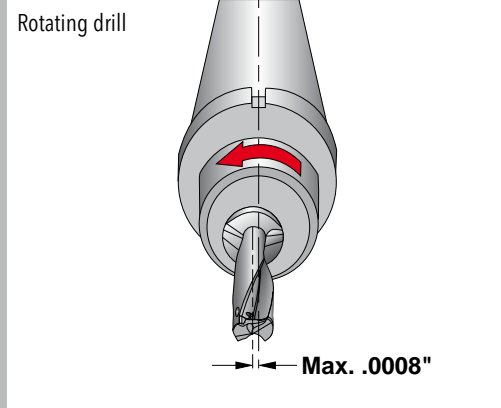
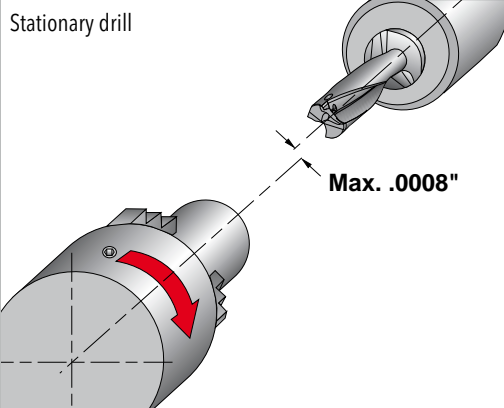

Fig. 5



SET-UP: RUN-OUT TOLERANCE



POWER/FORCE REQUIREMENTS

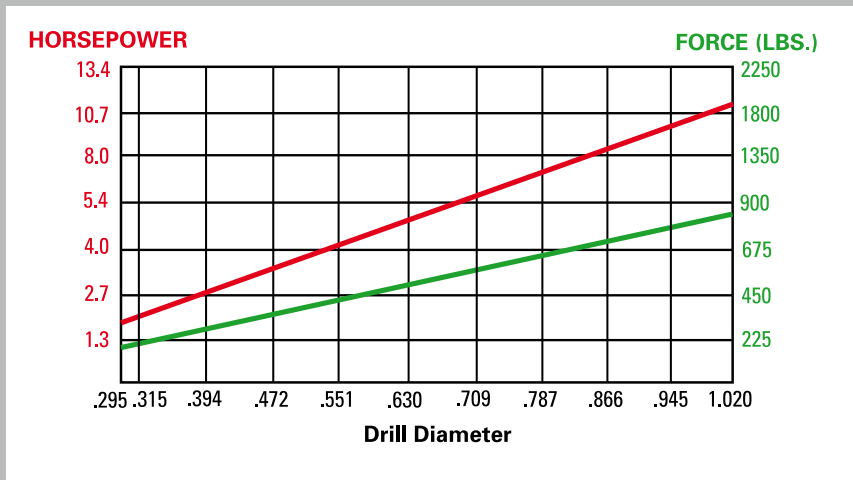

Material: SAE 4340
 Speed: 330 SFM
 Feed: .008 ipr

Values change according to different materials and drilling conditions.

QWIK•TWIST 8:1 DRILLS

- In case of stationary applications- on lathes- a high degree of radial and angular alignment between the chuck and the turret is required.
- The recommended cutting parameters for 8:1 drills is 20% lower than the cutting speeds used for the 3:1 and 5:1 drills.

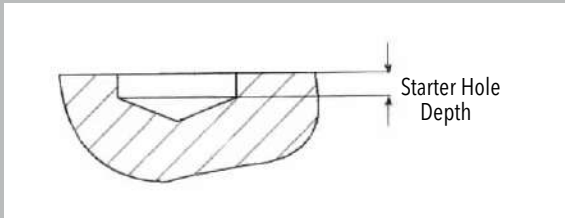

Starter Hole Guide

Hole Diameter Range	Drill Body Number 8:1	Starter Hole Depth	Starter Hole Body Number 3:1
.3937 .4291	YD1000080C0R01	.20	YD1000030C0R01
.4331 .4685	YD1100088C0R01	.20	YD1100033C0R01
.4724 .5079	YD1200096C0R01	.20	YD1200036C0R01
.5118 .5472	YD1300104C0R01	.20	YD1300039C0R01
.5512 .5866	YD1400112C0R01	.20	YD1400042C0R01
.5906 .6260	YD150012018R01	.20	YD150004518R01
.6299 .6654	YD160012818R01	.20	YD160004818R01
.6693 .7047	YD170013618R01	.20	YD170005118R01
.7087 .7441	YD1800144C8R01	.20	YD1800054C8R01
.7480 .7835	YD1900152C8R01	.20	YD1900057C8R01
.7874 .8228	YD2000160C8R01	.20	YD2000060C8R01
.8268 .8622	YD2100168C8R01	.20	YD2100063C8R01
.8661 .9016	YD2200176C8R01	.20	YD2200066C8R01
.9055 .9409	YD2300184C8R01	.20	YD2300069C8R01
.9449 .9803	YD2400192C8R01	.20	YD2400072C8R01
.9843 1.0197	YD2500200C8R01	.20	YD2500075C8R01

We strongly recommend the use of a 3:1 Qwik•Twist drill of the same diameter to drill a centering starter hole. The use of a centering starter hole improves hole location, accuracy, roundness, straightness and surface finish.

DRILLING AND CHAMFERING IN ONE OPERATION

Mounting Instructions:

- 1 Insert the Chamfer Ring on the drill body and slide to the desired position ⁽¹⁾.
- 2 Rotate the ring clockwise until the stopper engages the flute edge.
- 3 Tighten the ring clamp screw according to the maximum tightening torque indicated in the table below.
- 4 Mount the chamfer insert. (Torque 35 in. lbs.).
- 5 Mount the Qwik•Twist Drill Point.

⁽¹⁾ Mount the ring on the drill body subject to the limitations shown in the drawing to the right and the position possibilities in the table "Chamfer Ring Position Range" on the next page.

Maximum Tightening Torque- Ring Clamp Screw		
Ring Number	Ring Clamp Screw	Torque
CB100-01 thru CB150-01	SD050-A5	62 in. lbs.
CB160-01 thru CB200-01	SD060-20	88 in. lbs.

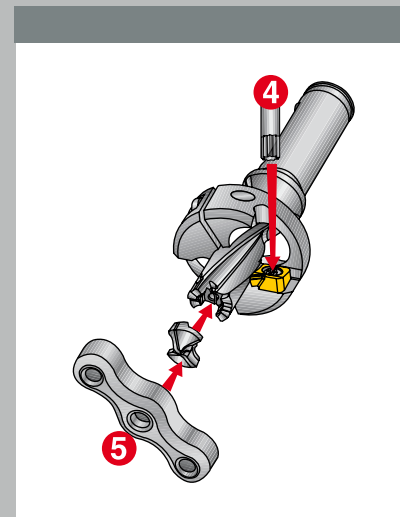
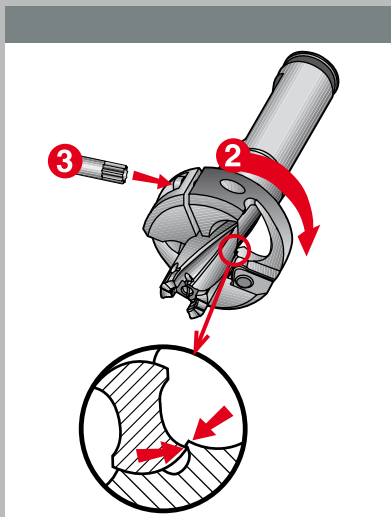
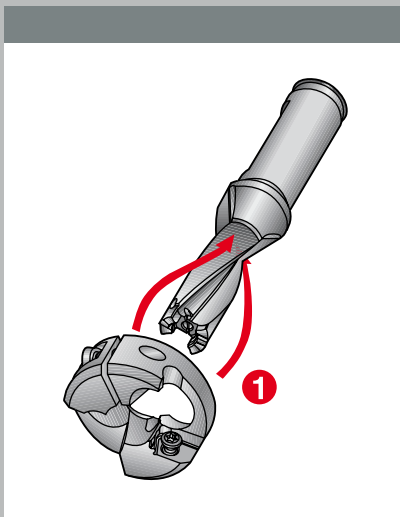
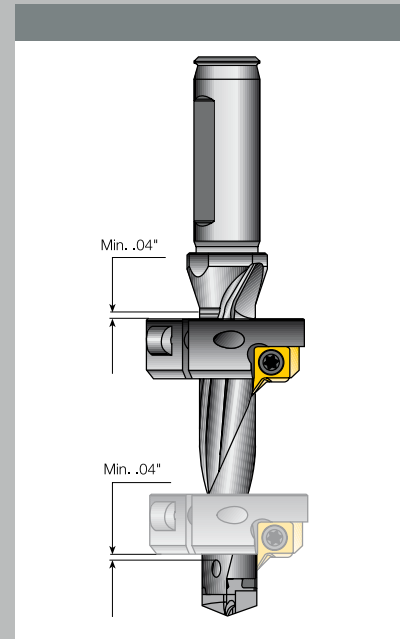

Before drilling insure that:

- There exists a very small gap between the chamfer insert and the drill body, but without contact (i.e., chamfer insert should not be in contact with the drill body).
- The cutting edge point (45°) is aligned with the flute edge.

Chamfer Ring Position Range

Drill Diameter	Drill Body 3xD L (min-max)	Drill Body 5xD L (min-max)	Maximum Chamfer Size
.394	.31-.63	.59-1.42	.06
.413	.31-.71	.67-1.54	
.433	.31-.75	.71-1.61	
.453	.31-.83	.79-1.73	
.472	.31-.87	.83-1.81	
.492	.31-.94	.91-1.93	
.512	.31-.98	.94-2.01	
.531	.31-1.06	1.02-2.13	
.551	.35-1.14	1.10-2.24	
.571	.35-1.22	1.18-2.36	
.591	.35-1.18	1.14-2.36	.08
.630	.35-1.30	1.26-2.56	
.699	.43-1.38	1.34-2.72	
.709	.43-1.50	1.46-2.91	
.748	.43-1.65	1.61-3.15	
.787	.43-1.77	1.73-3.35	

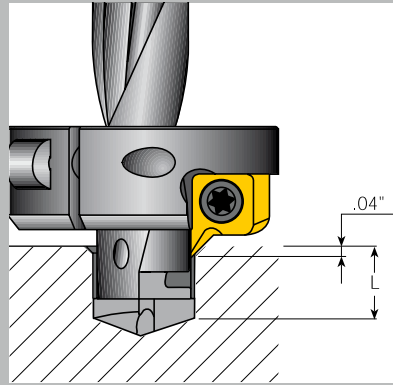

The "L" dimension shown is for a .04" chamfer. For other sizes, adjust "L" accordingly.

User Guide

Recommendation for better stability:

- Use 3xD drill instead of 5xD, if possible.
- Mount the ring as close as possible to the drill shank.
- In order to get better chamfer insert life, it is suggested to apply coolant to the chamfer insert in addition to the through the drill coolant and/or external coolant.
- A wider difference "X" between the drill body and the replaceable point size is preferred (i.e., for .575" replaceable point select .551" drill body rather than .571"). A slightly larger "X" dimension can dramatically increase the chamfer insert life.

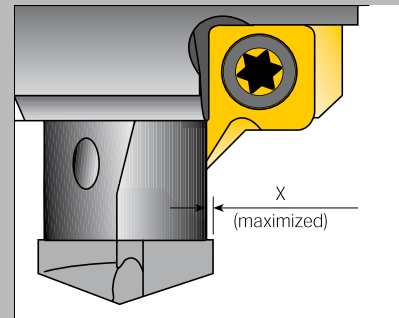

Trouble Shooting

- Bad chamfer surface finish (vibrations)
 - Solutions:
 - Use a shorter drill.
 - Move the ring closer to the drill shank.
 - Reduce the cutting speed while cutting th chamfer.
- Chips packed on the ring flutes:
 - Ensure that the ring is positioned as shown in the mounting instructions.
 - Adjust the cutting speed.
 - Use a pecking cycle.

CONSTRUCTION

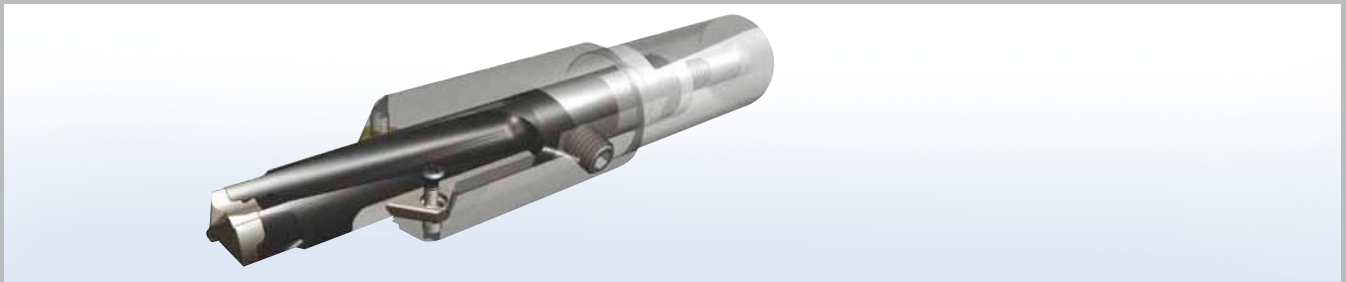

CHAMFER SHANK / SLIP FIT DRILL INITIAL SET-UP

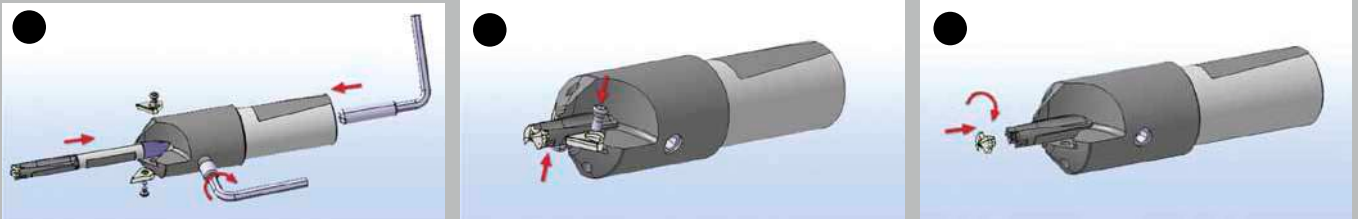

- Unscrew the Chamfer Shank side lock screw, the chamfer insert screws, and remove inserts. Insert the proper Slip Fit Drill into the Chamfer Shank and position it against the rear adjusting screw. Slightly tighten the side lock screw for initial tension with the Slip Fit Drill.
- In order to achieve symmetrical positioning of the chamfering inserts and to avoid edge damage, tighten the insert screws gradually and alternately from side to side insuring the inserts are tightly clamped against the side walls of the peripheral guiding surfaces. Tighten the side lock screw.
- Install the proper size Qwik Twist Drill point on the Slip Fit Drill.

DRILL DEPTH ADJUSTMENT ADJUSTMENT

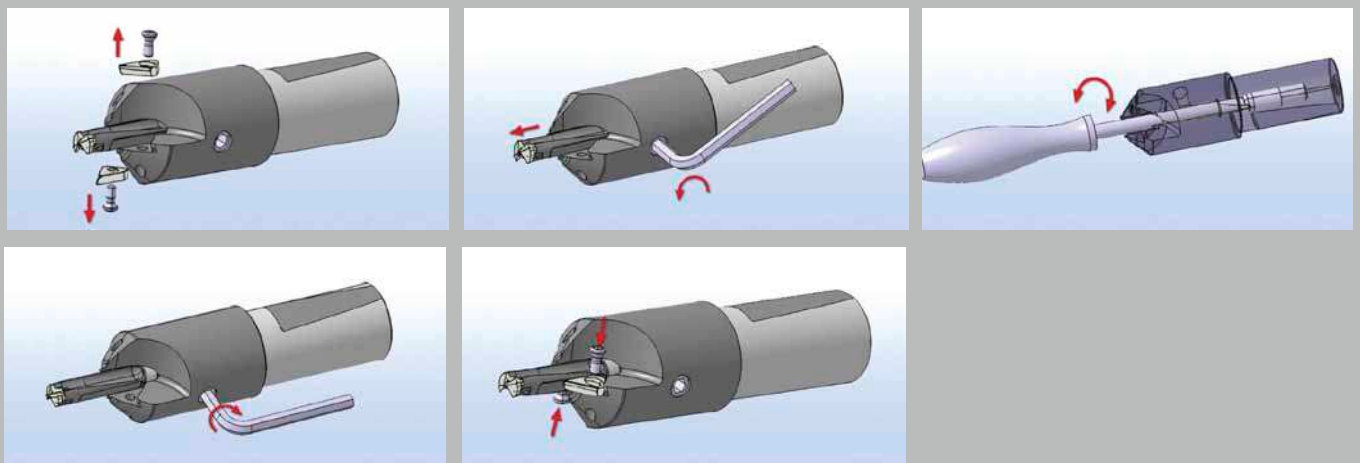

- Remove Chamfer inserts.
- Loosen the side lock screw and remove the Slip Fit Drill.
- Adjust the rear adjusting screw with a flat point screw driver.
- Insert Slip Fit Drill and slightly tighten the side lock screw.
- Re-install Chamfer Inserts as per Initial Set-up Instructions #2. Tighten side lock screw.

GENERAL APPLICATION INFORMATION

QuadDrills are One-Effective. Indexable drills are one-effective cutting geometry regardless of the number of inserts in the tool. This is extremely important when establishing feeds and speeds for a given operation.

Rigidity. A high degree of rigidity of the machine and fixturing is critical for indexable drilling.

Spindle Rigidity. If the spindle is not tight or properly adjusted, the drill will cut off-center, producing oversize holes. Insert chipping or low tool life may also result and hole finish will be affected.

Fixture Rigidity. Workpiece strength is essential. Flimsy or inadequately supported workpieces will render indexable drills virtually ineffective.

Chip Control. Chip control is essential for indexable drilling. Proper chip control directly enhances chip evacuation, which extends tool life and improves hole tolerance and finish (see Fig. 2).

Large, long chips will restrict the flutes' capacity to evacuate chips, and cause insert chipping and possible drill failure.

Operating parameters should be adjusted to fall within recommended guidelines to achieve optimum form or figure "9" chips that can successfully evacuate along the drill flutes.

Coolant. In drilling, heat and chips are generated in a confined area at the bottom of the hole. Coolant must be used as a carrier to extract heat and chips from the bottom of the hole, along the drill flutes and out of the hole.

Through the tool water base or synthetic coolant is strongly recommended.

Do not operate indexable drills over 1:1 diameter to length ratios with air, air mist or dry. Running drills under those conditions can result in drill failure.

Fig. 2: Chip Formation



Optimum form



Too tight: Increase speed within recommended limit. If unsatisfactory, decrease feed.



Too long: May clog drill flutes. Reduce speed or increase feed within recommended limits.

HOLE TOLERANCE

Drilling Depth	Hole Tolerance (inch)
2xD	+ .008 / - .004
3xD	+ .010 / - .004
4xD	+ .012 / - .004
5xD	+ .016 / - .004

Recommendations are starting parameters only and can be effected by cutting conditions such as spindal and fixture rigidity. Minimum 250 psi coolant through the tool is required for proper drill performance. If not possible, then cutting parameters may have to be reduced. Start at the midpoint of the range and adjust the cutting parameters according to your cutting conditions.

For drills that are 4:1 length to diameter ratio, it may be necessary to reduce your feed by 40% for the first .06" of drilling depth. Then increase to full feed rate for the remainder of the cut.

ISO	Material Number	Cutting Speed(SFM)	Feed (in/rev) ø.500 - ø.594	Feed (in/rev) ø.625 - ø.813	Feed (in/rev) ø.843 - ø1.063	Feed (in/rev) ø1.094 - ø1.312	Feed (in/rev) ø1.343 - ø1.625
P	1	800 - 1000	.002" - .004"	.0025" - .004"	.0025" - .005"	.003" - .005"	.003" - .006"
	2	800 - 1000	.002" - .004"	.0025" - .004"	.0025" - .005"	.003" - .005"	.003" - .006"
	3	500 - 800	.002" - .004"	.003" - .006"	.004" - .007"	.005" - .0085"	.005" - .0095"
	4	800 - 1000	.002" - .004"	.003" - .006"	.004" - .007"	.005" - .0085"	.005" - .0095"
	5	600 - 800	.002" - .004"	.003" - .006"	.004" - .007"	.005" - .0085"	.005" - .0095"
	6	500 - 800	.002" - .004"	.003" - .0055"	.004" - .007"	.005" - .0085"	.005" - .009"
	7	400 - 700	.002" - .005"	.003" - .006"	.004" - .007"	.005" - .008"	.006" - .009"
	8	400 - 600	.002" - .005"	.003" - .006"	.004" - .007"	.005" - .008"	.006" - .009"
	9	300 - 550	.002" - .005"	.003" - .006"	.004" - .007"	.005" - .008"	.006" - .009"
	10	400 - 600	.002" - .005"	.003" - .006"	.004" - .007"	.005" - .008"	.006" - .009"
	11	400 - 550	.002" - .005"	.003" - .006"	.004" - .008"	.005" - .009"	.006" - .0095"
M	12	550 - 800	.002" - .004"	.003" - .006"	.003" - .006"	.0035" - .0065"	.004" - .007"
	13	500 - 700	.002" - .004"	.003" - .006"	.003" - .006"	.0035" - .0065"	.004" - .007"
	14	500 - 700	.002" - .004"	.003" - .006"	.003" - .006"	.0035" - .0065"	.004" - .007"
K	15	500 - 800	.002" - .004"	.003" - .0065"	.005" - .008"	.006" - .010"	.006" - .011"
	16	500 - 800	.002" - .004"	.003" - .0065"	.005" - .008"	.006" - .010"	.006" - .011"
	17	600 - 800	.002" - .004"	.003" - .0065"	.005" - .008"	.006" - .010"	.006" - .011"
	18	600 - 800	.002" - .004"	.003" - .0065"	.005" - .008"	.006" - .010"	.006" - .011"
	19	600 - 800	.002" - .004"	.003" - .0065"	.005" - .008"	.006" - .010"	.006" - .011"
	20	500 - 700	.002" - .004"	.003" - .0065"	.005" - .008"	.006" - .010"	.006" - .011"
N	21	1300 - 2000	.002" - .005"	.003" - .006"	.004" - .008"	.005" - .009"	.0055" - .009"
	22	1000 - 1300	.002" - .005"	.003" - .006"	.004" - .008"	.005" - .009"	.0055" - .009"
	23	1300 - 2000	.002" - .005"	.003" - .006"	.004" - .008"	.005" - .009"	.0055" - .009"
	24	1000 - 1300	.002" - .005"	.003" - .006"	.004" - .008"	.005" - .009"	.0055" - .009"
	25	1000 - 1300	.002" - .005"	.003" - .006"	.004" - .008"	.005" - .009"	.0055" - .009"
	26	800 - 1000	.002" - .005"	.003" - .006"	.004" - .008"	.005" - .009"	.0055" - .009"
	27	750 - 900	.002" - .005"	.003" - .006"	.004" - .008"	.005" - .009"	.0055" - .009"
	28	800 - 1000	.002" - .005"	.003" - .006"	.004" - .008"	.005" - .009"	.0055" - .009"
	29						
	30						
S	31	100 - 250	.002" - .004"	.0025" - .0055"	.003" - .007"	.004" - .0085"	.0055" - .009"
	32	100 - 250	.002" - .004"	.0025" - .0055"	.003" - .007"	.004" - .0085"	.0055" - .009"
	33	100 - 250	.002" - .004"	.0025" - .0055"	.003" - .007"	.004" - .0085"	.0055" - .009"
	34	100 - 250	.002" - .004"	.0025" - .0055"	.003" - .007"	.004" - .0085"	.0055" - .009"
	35	100 - 250	.002" - .004"	.0025" - .0055"	.003" - .007"	.004" - .0085"	.0055" - .009"
	36	100 - 250	.002" - .004"	.0025" - .0055"	.003" - .007"	.004" - .0085"	.0055" - .009"
	37	100 - 200	.002" - .004"	.0025" - .0055"	.003" - .007"	.004" - .0085"	.0055" - .009"
H	38	50 - 150	.001" - .002"	.001" - .002"	.001" - .003"	.002" - .003"	.002" - .003"
	39	50 - 150	.001" - .002"	.001" - .002"	.001" - .003"	.002" - .003"	.002" - .003"
	40	50 - 150	.001" - .002"	.001" - .002"	.001" - .003"	.002" - .003"	.002" - .003"
	41	50 - 150	.001" - .002"	.001" - .002"	.001" - .003"	.002" - .003"	.002" - .003"

● = P ● = M ● = K ● = N ● = S ○ = H

OFFSETTING ROTATING INDEXABLE DRILLS

Offsetting indexable drills in a positive direction has proven to be beneficial in several ways. Reports indicate that it improves chip evacuation when applied to machines with inadequate coolant.

Offsetting can reduce chatter and noticeably improve surface finish when cutting materials like 316 stainless steel. It also allows drilling a full range of hole diameters with a minimum of drill sizes.

A complete list of "Maximum Offset" dimensions for each standard drill size is shown here. Remember, only 2:1 and 3:1 L/D ratio drills are recommended for this type of work because of their rigidity.

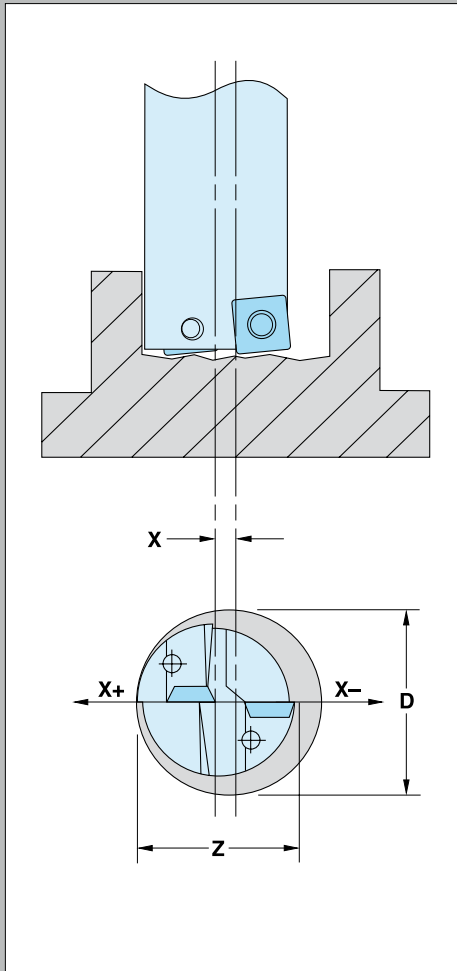

Z Drill Diameter	X Max. Radial Offset	Max. offset Dia.
.500	.010	.520
.531	.010	.551
.563	.010	.583
.594	.010	.614
.625	.020	.665
.657	.020	.697
.688	.020	.728
.719	.020	.759
.750	.020	.790
.781	.020	.821
.813	.010	.833
.844	.020	.884
.875	.020	.915
.906	.020	.946
.938	.020	.978
.969	.020	1.009
1.000	.010	1.020
1.031	.010	1.051
1.063	.010	1.083
1.094	.020	1.134
1.125	.020	1.165
1.156	.020	1.196
1.187	.020	1.227
1.219	.010	1.239
1.250	.010	1.270
1.281	.010	1.301
1.312	.010	1.332
1.343	.020	1.383
1.375	.020	1.415
1.406	.020	1.446
1.437	.020	1.477
1.468	.020	1.508
1.500	.020	1.540
1.531	.020	1.571
1.562	.010	1.582
1.594	.010	1.614
1.625	.010	1.645
1.687	.020	1.727
1.719	.020	1.759
1.750	.020	1.790
1.781	.020	1.821
1.813	.020	1.853
1.875	.010	1.895
1.937	.010	1.957
1.969	0.00 - no offset possible	
2.000	0.00 - no offset possible	
2.125	.010	2.145
2.250	.040	2.330
2.375	.015	2.405
2.500	.015	2.530
2.625	.015	2.655
2.750	0.00 - no offset possible	
2.875	.020	2.915
3.000	.015	3.030
3.250	.060	3.370

STATIONARY DRILLING

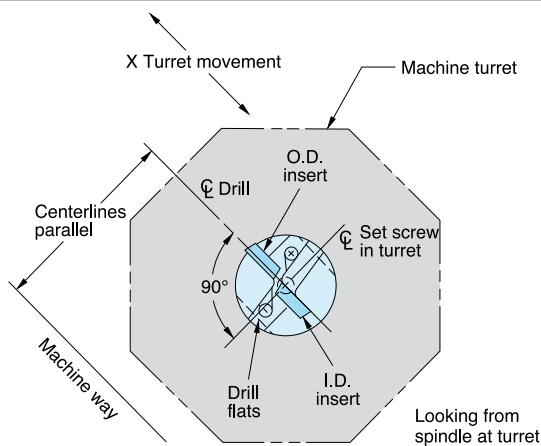

When setting up an indexable drill, it is always a good idea to locate the drill in the turret in an attitude that puts the inserts parallel to the machine ways. Most lathes have more than one set of screws in the turret that allows this.

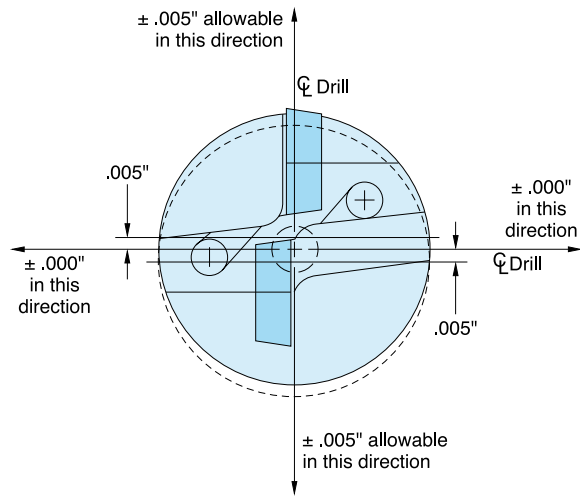

When using drills on the lathe, the drills must be properly aligned prior to taking the first cut. Plus, periodic alignment checks must be made to insure the continued accuracy of the setup.

DRILLING CONDITIONS

Common drilling applications with flat or convex surfaces generally require no speed or feed adjustment during the drilling cycle.

Special situations however, may necessitate temporary adjustments. In the examples below, reductions to feed and/or speed may be required to minimize deflection or tool wear.

Material surface conditions such as case hardening or scale may require slowing penetration to some degree. Interior conditions

such as porosity, sandy castings, etc., also have some effect on tool life. Operating parameters may have to be adjusted accordingly.

Feedrates on 4:1 drills may need to be reduced even more than the recommendations below indicate. Generally, this reduced feedrate is required until the first .200" DOC after full engagement is reached.

Most Common Conditions

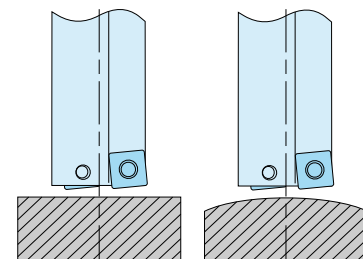

Flat

Convex

Less Common Conditions

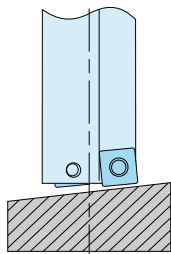

Sloped: If slope exceeds 5°, reduce feed by 50% during penetration.

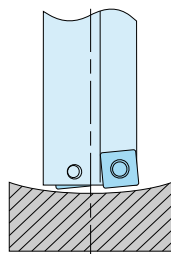

Concave: Reduce feed by 60% during penetration.

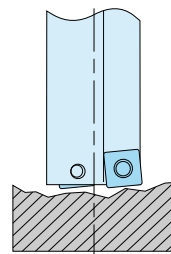

Irregular: Reduce speed during penetration.

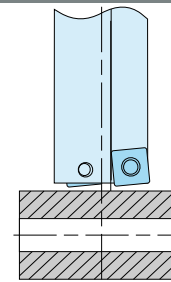

Interrupted: Reduce feed when crossing and before penetration.

ASSEMBLY, SET-UP AND ADJUSTMENT PROCEDURES



Recommend using Weldon style end mill adapter that uses two side locking screws.

1. Scribe line on front face of adapter exactly 90 degrees from locking screws.
2. Load eccentric bushing over drill shank and into adapter lining up the scribed line on adapter and bushing.
3. Before locking the set screws in adapter, line up OD insert in drill with both scribed lines on the bushing and adapter. The drill in this position will drill a nominal (drill size) hole diameter.
4. With the drill and bushing loaded into the adapter and the OD insert in line with the scribed lines, apply the rear set screw (B) in adapter locking the bushing in place. Use only hand pressure to tighten the screw. Applying the set screw to the bushing provides positive axial retention of the bushing and hand tightening allows radial adjustment.
5. Rotate the bushing either plus or minus to desired position then lock the (B) set screw using a wrench. This will lock the radial position setting in preparation for drilling.
6. Lock the front (A) set screw in the adapter using a wrench to lock the drill into the holder.

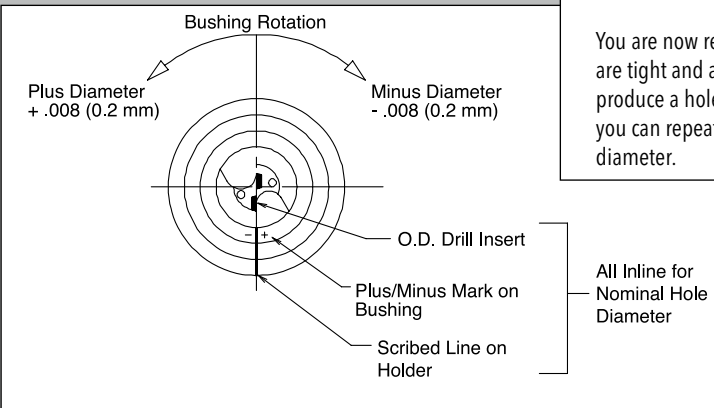

You are now ready to drill. Please check to make sure all screws are tight and assembly is rigid before drilling. Once you produce a hole with the current setting and inspect the diameter, you can repeat procedures #5 & 6 if required to achieve desired diameter.

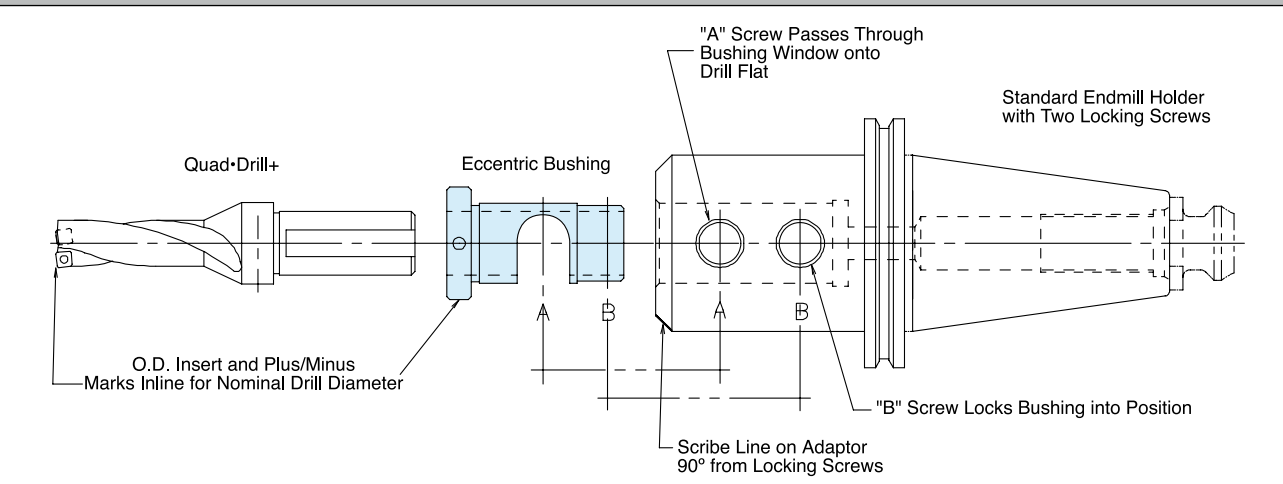

QUADBORE™ 15S OPERATING GUIDELINES

ISO	Material Number	Cutting Speed (SFM)	Feed (in/rev) ø.500 - E.750	Feed (in/rev) ø1.000	Feed (in/rev) ø.813 - ø1.500	Feed (in/rev) ø1.625 - ø2.000	Insert Grade*
P	1	500 - 1000	.002" - .006"	.004" - .007"	.005" - .008"	.006" - .010"	
	2	500 - 1000	.002" - .006"	.004" - .007"	.005" - .008"	.006" - .010"	
	3	400 - 900	.002" - .006"	.003" - .006"	.004" - .007"	.005" - .0085"	IN 2005
	4	700 - 900	.002" - .006"	.003" - .006"	.004" - .007"	.005" - .0085"	
	5	700 - 900	.002" - .006"	.003" - .006"	.004" - .007"	.005" - .0085"	
	6	500 - 800	.002" - .006"	.003" - .0055"	.004" - .007"	.005" - .0085"	IN 1030
	7	500 - 800	.002" - .005"	.003" - .006"	.004" - .007"	.005" - .008"	
	8	500 - 800	.002" - .005"	.003" - .006"	.004" - .007"	.005" - .008"	
	9	500 - 800	.002" - .005"	.003" - .006"	.004" - .007"	.005" - .008"	IN 6515
	10	350 - 550	.002" - .005"	.003" - .006"	.004" - .007"	.005" - .008"	
	11	350 - 550	.002" - .005"	.003" - .006"	.004" - .008"	.005" - .009"	
M	12	450 - 750	.002" - .005"	.004" - .006"	.007" - .009"	.008" - .010"	IN 2005
	13	375 - 600	.002" - .005"	.004" - .006"	.007" - .009"	.008" - .010"	
	14	375 - 600	.002" - .005"	.004" - .006"	.007" - .009"	.008" - .010"	IN 1030
K	15	500 - 800	.002" - .005"	.003" - .0065"	.004" - .007"	.005" - .008"	
	16	500 - 800	.002" - .005"	.003" - .0065"	.004" - .007"	.005" - .008"	IN 6515
	17	600 - 800	.002" - .005"	.003" - .0065"	.004" - .007"	.005" - .008"	
	18	600 - 800	.002" - .005"	.003" - .0065"	.004" - .007"	.005" - .008"	IN 2005
	19	600 - 800	.002" - .005"	.003" - .0065"	.004" - .007"	.005" - .008"	
	20	500 - 700	.002" - .005"	.003" - .0065"	.004" - .007"	.005" - .008"	IN 1030
N	21	1100 - 1800	.003" - .006"	.004" - .006"	.006" - .008"	.007" - .010"	
	22	800 - 1100	.003" - .006"	.004" - .006"	.006" - .008"	.007" - .010"	IN 30M
	23	1100 - 1800	.003" - .006"	.004" - .006"	.006" - .008"	.007" - .010"	
	24	800 - 1100	.003" - .006"	.004" - .006"	.006" - .008"	.007" - .010"	IN 1030
	25	800 - 1100	.003" - .006"	.004" - .006"	.006" - .008"	.007" - .010"	
	26	600 - 800	.003" - .006"	.004" - .006"	.006" - .008"	.007" - .010"	IN 2005
	27	550 - 700	.003" - .006"	.004" - .006"	.006" - .008"	.007" - .010"	
	28	600 - 800	.003" - .006"	.004" - .006"	.006" - .008"	.007" - .010"	IN 1030
	29						
	30						
S	31	100 - 250	.002" - .004"	.003" - .005"	.004" - .006"	.005" - .007"	
	32	100 - 250	.002" - .004"	.003" - .005"	.004" - .006"	.005" - .007"	IN 2005
	33	100 - 250	.002" - .004"	.003" - .005"	.004" - .006"	.005" - .007"	
	34	100 - 250	.002" - .004"	.003" - .005"	.004" - .006"	.005" - .007"	
	35	100 - 250	.002" - .004"	.003" - .005"	.004" - .006"	.005" - .007"	
	36	100 - 250	.002" - .004"	.003" - .005"	.004" - .006"	.005" - .007"	IN 1030
	37	100 - 200	.002" - .004"	.003" - .005"	.004" - .006"	.005" - .007"	
H	38	50 - 150	.001" - .002"	.001" - .002"	.001" - .003"	.002" - .003"	IN 6515
	39	50 - 150	.001" - .002"	.001" - .002"	.001" - .003"	.002" - .003"	
	40	50 - 150	.001" - .002"	.001" - .002"	.001" - .003"	.002" - .003"	IN 2005
	41	50 - 150	.001" - .002"	.001" - .002"	.001" - .003"	.002" - .003"	

○=P ●=M ●=K ●=N ●=S ○=H

QUADBORE™ 15C OPERATING GUIDELINES

ISO	Material Number	Cutting Speed (SFM)	Feed (in/rev) ø.438 - ø.719	Feed (in/rev) ø.812	Feed (in/rev) ø1.000 - ø1.500	Feed (in/rev) ø1.750 - ø2.000	Insert Grade*
P	1	500 - 1000	.004" - .010"	.006" - .011"	.008" - .014"	.010" - .016"	
	2	500 - 1000	.004" - .010"	.006" - .011"	.008" - .014"	.010" - .016"	
	3	400 - 900	.004" - .010"	.004" - .011"	.007" - .012"	.010" - .017"	IN 2005
	4	700 - 900	.004" - .010"	.004" - .011"	.007" - .012"	.010" - .017"	
	5	700 - 900	.004" - .010"	.004" - .011"	.007" - .012"	.010" - .017"	
	6	500 - 800	.004" - .010"	.004" - .011"	.007" - .012"	.010" - .017"	IN 1030
	7	500 - 800	.004" - .009"	.004" - .011"	.007" - .012"	.009" - .015"	
	8	500 - 800	.004" - .009"	.004" - .011"	.007" - .012"	.009" - .015"	
	9	500 - 800	.004" - .009"	.004" - .011"	.007" - .012"	.009" - .015"	IN 6515
	10	350 - 550	.004" - .009"	.004" - .011"	.007" - .012"	.009" - .015"	
	11	350 - 550	.004" - .009"	.004" - .011"	.008" - .014"	.010" - .016"	
M	12	450 - 750	.004" - .009"	.006" - .010"	.012" - .016"	.014" - .018"	IN 2005
	13	375 - 600	.004" - .009"	.006" - .010"	.012" - .016"	.014" - .018"	
	14	375 - 600	.004" - .009"	.006" - .010"	.012" - .016"	.014" - .018"	IN 1030
K	15	500 - 800	.004" - .009"	.004" - .010"	.007" - .013"	.010" - .015"	
	16	500 - 800	.004" - .009"	.004" - .010"	.007" - .013"	.010" - .015"	IN 6515
	17	600 - 800	.004" - .009"	.004" - .010"	.007" - .013"	.010" - .015"	
	18	600 - 800	.004" - .009"	.004" - .010"	.007" - .013"	.010" - .015"	IN 2005
	19	600 - 800	.004" - .009"	.004" - .010"	.007" - .013"	.010" - .015"	
	20	500 - 700	.004" - .009"	.004" - .010"	.007" - .013"	.010" - .015"	IN 1030
N	21	1100 - 1800	.006" - .011"	.006" - .010"	.012" - .015"	.013" - .018"	
	22	800 - 1100	.006" - .011"	.006" - .010"	.012" - .015"	.013" - .018"	IN 30M
	23	1100 - 1800	.006" - .011"	.006" - .010"	.012" - .015"	.013" - .018"	
	24	800 - 1100	.006" - .011"	.006" - .010"	.012" - .015"	.013" - .018"	
	25	800 - 1100	.006" - .011"	.006" - .010"	.012" - .015"	.013" - .018"	IN 1030
	26	600 - 800	.006" - .011"	.006" - .010"	.012" - .015"	.013" - .018"	
	27	550 - 700	.006" - .011"	.006" - .010"	.012" - .015"	.013" - .018"	
	28	600 - 800	.006" - .011"	.006" - .010"	.012" - .015"	.013" - .018"	IN 1030
	29						
	30						
S	31	100 - 250	.004" - .007"	.004" - .008"	.007" - .011"	.009" - .013"	
	32	100 - 250	.004" - .007"	.004" - .008"	.007" - .011"	.009" - .013"	IN 2005
	33	100 - 250	.004" - .007"	.004" - .008"	.007" - .011"	.009" - .013"	
	34	100 - 250	.004" - .007"	.004" - .008"	.007" - .011"	.009" - .013"	
	35	100 - 250	.004" - .007"	.004" - .008"	.007" - .011"	.009" - .013"	
	36	100 - 250	.004" - .007"	.004" - .008"	.007" - .011"	.009" - .013"	IN 1030
	37	100 - 200	.004" - .007"	.004" - .008"	.007" - .011"	.009" - .013"	
H	38	50 - 150	.002" - .003"	.002" - .003"	.002" - .005"	.004" - .006"	IN 6515
	39	50 - 150	.002" - .003"	.002" - .003"	.002" - .005"	.004" - .006"	
	40	50 - 150	.002" - .003"	.002" - .003"	.002" - .005"	.004" - .006"	IN 2005
	41	50 - 150	.002" - .003"	.002" - .003"	.002" - .005"	.004" - .006"	

●=P ●=M ●=K ●=N ●=S ○=H

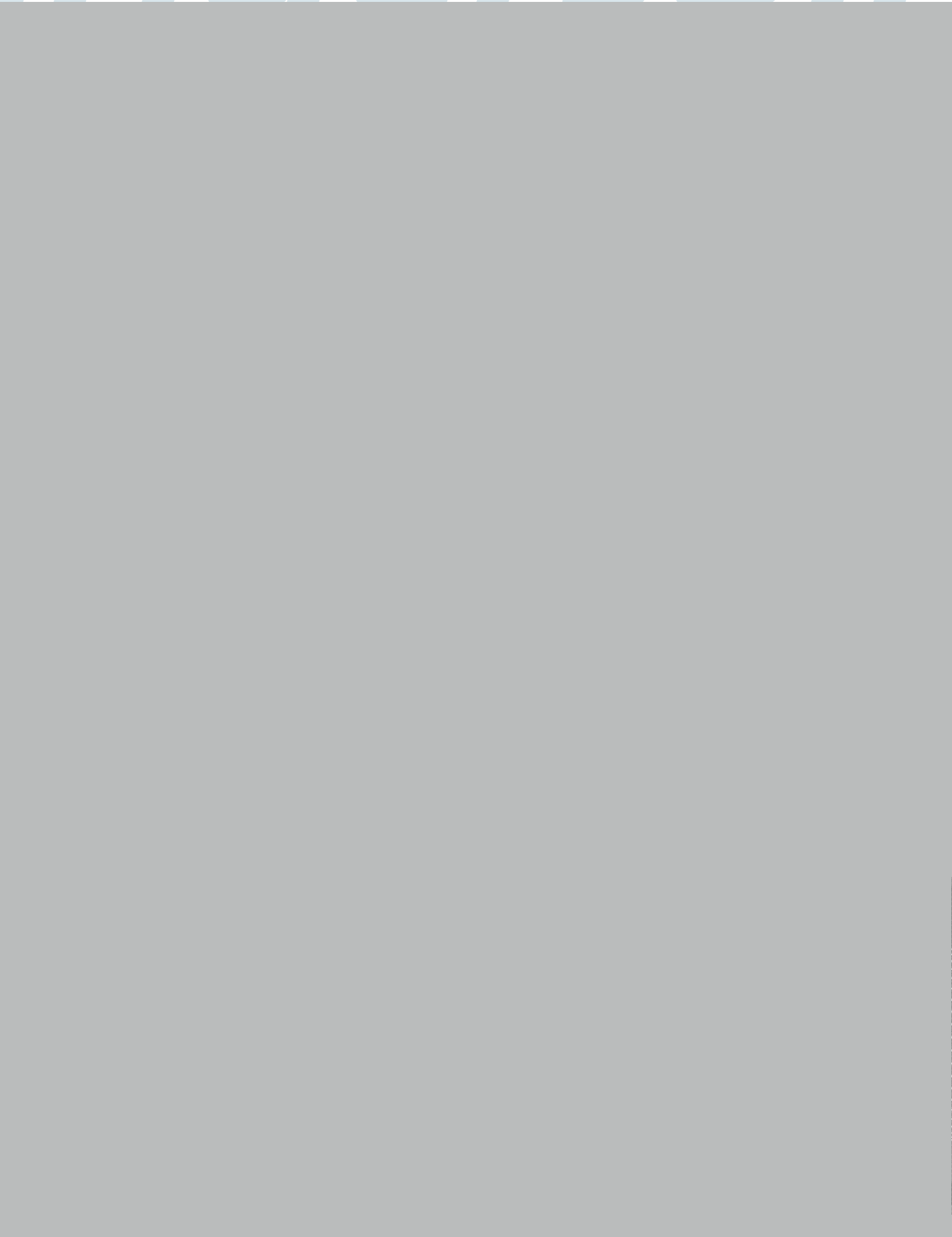

QWIKREAM MACHINING RECOMMENDATIONS - HIGH SPEED REAMING

Mtl. No.	Material	SFM Cutting Speed Vc (m/min)	10./ Rev Feed (mm/rev)			
			Straight Flute		Spiral Flute	
			D=.532"-.630" (13.501-16.000)	D=.630"-.787" (16.000-20.000)	D=.532"-.630" (13.501-16.000)	D=.630"-.787" (16.000-20.000)
1 2 3 4 5	Non-alloyed steel, cast steel, free cutting steel	250-650 (80-200)	.027-.043 (0.7-1.1)	.030-.047 (0.8-1.2)	.030-.055 (0.8-1.4)	.040-.060 (1.0-1.5)
6 7 8 9	Low alloyed steel and cast steel (less than 5% of alloying elements)	250-400 (80-120)	.027-.043 (0.7-1.1)	.030-.047 (0.8-1.2)	.030-.055 (0.8-1.4)	.040-.060 (1.0-1.5)
10 11	High alloyed steel, cast steel, tool steel	115-160 (35-50)	.012-.027 (0.3-0.7)	.020-.030 (0.5-0.8)	.016-.030 (0.4-0.8)	.020-.035 (0.5-0.9)
12 13 14	Stainless steel and cast steel	65-135 (20-40)	.020-.027 (0.5-0.7)	.027-.035 (0.7-0.9)	.020-.040 (0.5-1.0)	.024-.047 (0.6-1.2)
15 16	Cast iron nodular (GGG)	135-450 (40-140)	.020-.047 (0.5-1.2)	.027-.060 (0.7-1.5)	.030-.047 (0.8-1.2)	.040-.080 (1.0-2.0)
17 18	Cast iron nodular (GG)	135-450 (40-140)	.020-.047 (0.5-1.2)	.027-.060 (0.7-1.5)	.030-.047 (0.8-1.2)	.040-.080 (1.0-2.0)
19 20	Malleable cast iron	320-750 (100-240)	.020-.047 (0.5-1.2)	.027-.060 (0.7-1.5)	.030-.047 (0.8-1.2)	.040-.080 (1.0-2.0)
21 22	Aluminum wrought alloy	1000-1600 ⁽¹⁾ (300-500)	.030-.040 (0.8-1.0)	.030-.040 (0.8-1.0)	.030-.040 (0.8-1.0)	.030-.040 (0.8-1.0)
23 24 25	Aluminum -cast, alloyed	1300-1600 ⁽¹⁾ (400-500)	.030-.040 (0.8-1.0)	.030-.040 (0.8-1.0)	.030-.040 (0.8-1.0)	.030-.040 (0.8-1.0)
26 27 28	Copper alloys	600-800 (180-250)	.024-.040 (0.6-1.0)	.024-.047 (0.6-1.2)	.024-.047 (0.6-1.2)	.040-.060 (1.0-1.5)
29 30	Non metallic	80-250 (25-80)	.024-.040 (0.6-1.0)	.024-.047 (0.6-1.2)	.024-.047 (0.6-1.2)	.040-.060 (1.0-1.5)

The data refers to IN2005 PVD coated grade.

⁽¹⁾ Condition for PCD reamer head.

QWIKREAM TROUBLESHOOTING

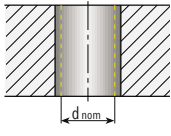
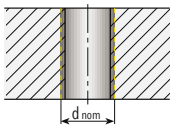
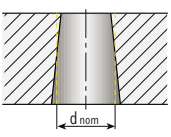
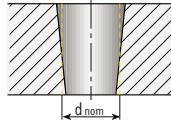
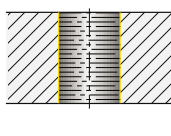
Problem	Cause	Solution
<p>Hole too large</p> 	<ul style="list-style-type: none"> • Reamer or pilot hole not centered • Reamer too large • Cooling / lubrication problems 	<ul style="list-style-type: none"> • Use a floating reamer chuck or correct pilot hole • Check reamer 's size and correct if necessary • Change lubricant and increase coolant pressure
<p>Hole too small</p> 	<ul style="list-style-type: none"> • Worn reamer • Reaming allowance too small • Cooling / lubrication problems 	<ul style="list-style-type: none"> • Replace the reamer • Increase reaming allowance • Change lubricant and increase coolant pressure
<p>Conical hole (larger bottom)</p> 	<ul style="list-style-type: none"> • Misalignment between pre-hole and reamer centers 	<ul style="list-style-type: none"> • Re-align or use a floating reamer chuck
<p>Conical hole (larger entrance)</p> 	<ul style="list-style-type: none"> • Misalignment between pre-hole and reamer centers • Material jammed between reamer and hole in the upper hole section 	<ul style="list-style-type: none"> • Re-align or use a floating reamer chuck • Secure the tool axially
<p>Poor surface finish</p> 	<ul style="list-style-type: none"> • Worn reamer • Misalignment between pre-hole and reamer centers • Problems with chip evacuation • Incorrect cutting parameters • Built-up edge 	<ul style="list-style-type: none"> • Replace the tool • Re-align or use a floating reamer chuck • Increase coolant pressure • Change cutting parameters • Change cutting parameters or coolant conditions

Application Form

Machine				
Manufacturer/ Brand		Type		
Tool	Rotating/Stationary	Component	Rotating/Stationary	
Machine Condition		Attachment to Spindle (BT, HSK...)		
Fix Feed	Yes / No	in/min [mm/min]	Min-Max Feed	in/min [mm/min]
Fix Rotation Speed	Yes / No	[RPM]	Min-Max RPM	[RPM]
Circular Runout of Spindle		[μ m]	Spindle Position	Vertical/Horizontal
Adapter				
Morse Taper	Yes / No	Morse Size		
Cylindrical Shank	Yes / No	Diameter	\emptyset	in [mm]
Whistle Notch	Yes / No	Weldon	Yes / No	
Type of Adapter (Floating, Adjustable)		Internal Coolant Supply	Yes / No	
Coolant	Yes / No			
Coolant				
Brand		Type		
Mixture Ratio		[%]	Coolant Pressure	PSI [Bar]
Coolant Capacity		Gal/min [Liter/min]		

Machining Details

Application Form

Existing Tool (for Running Application)			
Additional Information	Brand		Type
	Tool Life	[Holes]	Coolant Pressure PSI [Bar]
	No. of Teeth		Carbide Grade
	Coating		Holder Type (Shank)
	Cutting Speed	In/rev [m/min]	Feed In/rev [mm/rev]

Notes:



Application Form

Information Needed for the Preparation of Ingersoll QwikReam Quote

DATE: / /

Customer:

End User	Company	Contact Person
	Company Name	Name
	Company Address	Title
	Telephone	Telephone
	Fax	Fax
	Email	Email

Distributor	Company	Contact Person
	Company Name	Name
	Company Address	Title
	Telephone	Telephone
	Fax	Fax
	Email	Email

Application Form

Component: _____

Workpiece Description: _____

Drawing Number: _____

Please add drawings of the workpiece, final product and tool layout.

Workpiece	Material			
	Specification		Hardness	[HRc]
	Heat Treatment		Tensile Strength	[Mpa]
	Bore			
	Diameter	Inch [mm]	Tolerance	Inch [mm]
	Diameter of Pre-reamed Hole	Inch [mm]	Tolerance	Inch [mm]
	Method of Pre-reaming Hole		Depth of Bore	Inch [mm]
	Bore Type	Number (See table below)	Interruption Size/Length	Inch [mm]
	Surface Finish	[Ra]/[Rz]	Circularity	[μm/μinch]

Bore Type

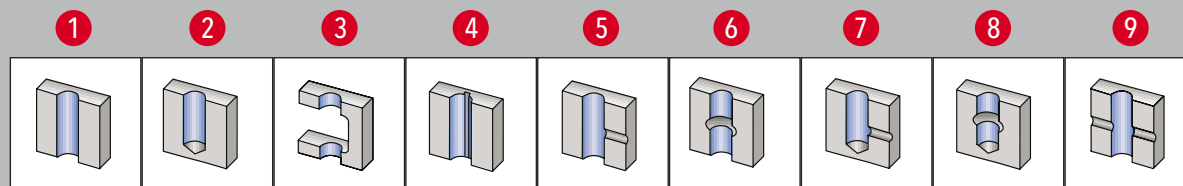

MACHINING DATA FOR INDEXABLE INSERT THREADING TOOLS

Main ISO-group	Workpiece Material	Remark	Tensile Strength	Hardness	Machin. Group
P	< 0,25 % C	Annealed	420	125	1
	Unalloyed steel $\geq 0,25$ % C	Annealed	650	190	2
	Cast steel < 0,25 % C	Tempered	850	250	3
	Free cutting steel $\geq 0,55$ % C	Annealed	750	220	4
		Tempered	1000	300	5
	Steel medium tensile strength and cast steel	Annealed	600	200	6
	(with less than 5 % C)	Tempered	930	275	7
		Tempered	1000	300	8
		Tempered	1200	350	9
	High-alloyed cast steel	Annealed	680	200	10
	Steel and tool steel	Tempered	1100	325	11
M	Stainless steel and cast steel	Ferritic, martensitic	680	200	12
		Martensitic	820	240	13
		Austenitic	600	180	14
K	Nodular gray cast iron (GGG)	Ferritic, pearlitic	-	180	15
	Gray cast iron (GG)	Pearlitic	-	260	16
	Gray cast iron (GG)	Ferritic	-	160	17
	Gray cast iron (GG)	Pearlitic	-	250	18
	Malleable cast iron	Ferritic	-	130	19
	Malleable cast iron	Pearlitic	-	230	20
N	Aluminum-wrought alloy	Untreated	-	60	21
	Aluminum-wrought alloy	Forged, alloyed	-	100	22
	Aluminum cast alloy ≤ 12 % Si	Untreated	-	75	23
	Aluminum cast alloy	Forged, alloyed	-	90	24
	Aluminum cast alloy > 12 % Si	High temp. resist.	-	130	25
	Copper alloys	Easy to machine	-	110	26
	CuZn-alloys (brass)		-	90	27
	Elektrolytic copper		-	100	28
	Duroplastics		-	90	29
	K Graphite		-	-	30
S	Ebonite		-	-	-
	High temp. resisting alloys	Fe-base, tempered	-	200	31
	Superalloys	Ni/Co-base, treated	-	280	32
	Superalloys	Ni/Co-base, tempered	-	250	33
	Superalloys	Ni/Co-base, treated	-	350	34
	Titanium, cast		-	320	35
	Titanium		400	-	36
	M Titanium alloys	Alpha & beta alloy, treated	1050	-	37
H	Hardened steel	Hardened	-	55 HRC	38
	Hardened steel	Hardened	-	60 HRC	39
	Chill casting	Cast	400	-	40
	P/K Cast iron	Hardened	-	55 HRC	41

MACHINING DATA FOR INDEXABLE INSERT THREADING TOOLS

IN 1030	IN 2030
Cutting speed (ft/min)	

500-590	600-725
410-495	525-625
265-330	330-400
230-300	300-360
200-265	230-330
400-525	495-660
300-500	360-600
265-400	330-495
320-330	300-400
200-265	320-330
180-230	230-300
430-725	525-885
265-660	330-755
330-430	400-525
230-400	300-600
200-400	230-495
430-790	525-985
360-660	500-755
590-1085	725-1345
855-955	660-1180
495-985	590-1120
495-985	590-1120
495-985	590-1120
495-985	590-1120
495-985	590-1120
495-985	590-1120
495-985	590-1120
495-985	590-1120
495-985	590-1120
495-985	590-1120
495-985	590-1120
100-135	135-165
85-115	100-330
85-115	100-330
85-115	100-330
135-265	165-330
135-265	165-330
135-265	165-330
-	-
-	-
-	-
-	-

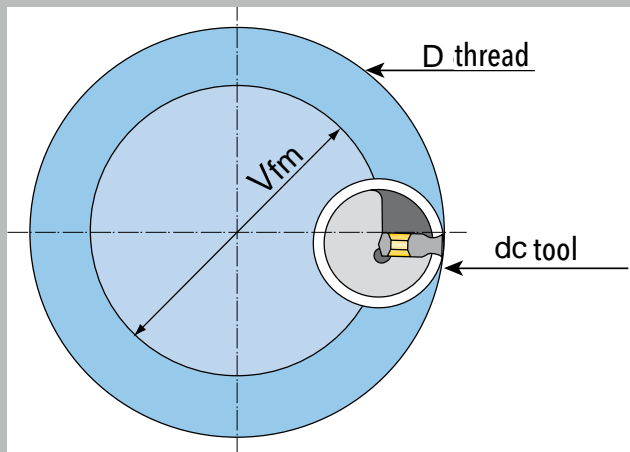

$$\text{Feed rate } V_{fm} = f_z \times \frac{(D-dc)}{D} \times n \times Z$$

- fz:** feed per tooth
- D:** diameter of thread
- dc:** diameter of tool
- Vfm:** feed rate of centerway of tool
- n:** RPM
- Z:** no. of teeth
- fz = 0.001 mm - 0.005 mm**
- max. tool dia. < 2/3 thread size**
- Example:**
M30 -> tool dia. : max. .750 mm

MACHINING DATA FOR SOLID CARBIDE TOOLS

Main ISO-group	Workpiece Material	Remark	Tensile Strength	Hardness	Machin. Group
P	< 0,25 % C	Annealed	420	125	1
	Unalloyed steel \geq 0,25 % C	Annealed	650	190	2
	Cast steel < 0,25 % C	Tempered	850	250	3
	Free cutting steel \geq 0,55 % C	Annealed	750	220	4
		Tempered	1000	300	5
	Steel medium tensile strength and cast steel	Annealed	600	200	6
	(with less than 5 % C)	Tempered	930	275	7
		Tempered	1000	300	8
		Tempered	1200	350	9
	High-alloyed cast steel	Annealed	680	200	10
	Steel and tool steel	Tempered	1100	325	11
M	Stainless steel and cast steel	Ferritic, martensitic	680	200	12
		Martensitic	820	240	13
		Austenitic	600	180	14
K	Nodular gray cast iron (GGG)	Ferritic, pearlitic	-	180	15
	Gray cast iron (GG)	Pearlitic	-	260	16
	Gray cast iron (GG)	Ferritic	-	160	17
	Malleable cast iron	Pearlitic	-	250	18
	Malleable cast iron	Ferritic	-	130	19
	Malleable cast iron	Pearlitic	-	230	20
N	Aluminum-wrought alloy	Untreated	-	60	21
	Aluminum-wrought alloy	Forged, alloyed	-	100	22
	Aluminum cast alloy	Untreated	-	75	23
	Aluminum cast alloy	Forged, alloyed	-	90	24
	Aluminum cast alloy $>$ 12 % Si	High temp. resist.	-	130	25
	Copper alloys	Easy to machine	-	110	26
	CuZn-alloys (brass)		-	90	27
	Elektrolytic copper		-	100	28
	Duroplastics		-	90	29
	Graphite		-	-	30
	Ebonite		-	-	-
S	High temp. resisting alloys	Fe-base, tempered	-	200	31
	Superalloys	Ni/Co-base, treated	-	280	32
	Superalloys	Ni/Co-base, tempered	-	250	33
	Superalloys	Ni/Co-base, treated	-	350	34
	Titanium, cast		-	320	35
	Titanium		400	-	36
	Titanium alloys	Alpha & beta alloy, treated	1050	-	37
H	Hardened steel	Hardened	-	55 HRC	38
	Hardened steel	Hardened	-	60 HRC	39
	Chill casting	Cast	400	-	40
	Cast iron	Hardened	-	55 HRC	41

MACHINING DATA FOR SOLID CARBIDE TOOLS

IN 2005	Feed (in/tooth) - Cutting Diameter											
	(ft/min)	Ø 0.078	Ø 0.125	Ø 0.156	Ø 0.250	Ø 0.312	Ø 0.390	Ø 0.484	Ø 0.562	Ø 0.625	Ø 0.781	Ø 0.984
330-1085	0.001	0.002	0.002	0.002	0.003	0.003	0.004	0.004	0.005	0.006	0.007	0.008
265-690	0.001	0.002	0.002	0.002	0.003	0.003	0.004	0.004	0.005	0.006	0.007	0.008
215-600	0.001	0.002	0.002	0.002	0.003	0.003	0.004	0.004	0.005	0.006	0.007	0.008
360-590	0.001	0.001	0.001	0.002	0.002	0.003	0.003	0.004	0.004	0.005	0.006	0.007
315-525	0.001	0.001	0.001	0.002	0.002	0.003	0.003	0.004	0.004	0.005	0.006	0.007
300-525	0.001	0.001	0.001	0.001	0.002	0.002	0.002	0.002	0.003	0.003	0.004	0.004
215-660	0.001	0.001	0.001	0.001	0.002	0.002	0.002	0.002	0.003	0.003	0.004	0.004
230-690	0.001	0.001	0.001	0.001	0.002	0.002	0.002	0.002	0.003	0.003	0.004	0.004
315-525	0.001	0.001	0.001	0.001	0.002	0.002	0.002	0.002	0.003	0.003	0.004	0.004
430-600	0.001	0.001	0.001	0.001	0.002	0.002	0.002	0.002	0.003	0.003	0.004	0.004
245-330	0.001	0.001	0.001	0.001	0.002	0.002	0.002	0.002	0.003	0.003	0.004	0.004
360-600	0.001	0.001	0.001	0.001	0.002	0.002	0.002	0.002	0.003	0.003	0.004	0.004
230-510	0.001	0.001	0.001	0.001	0.002	0.002	0.002	0.002	0.003	0.003	0.004	0.004
280-330	0.001	0.001	0.001	0.001	0.002	0.002	0.002	0.002	0.003	0.003	0.004	0.004
230-495	0.001	0.002	0.002	0.002	0.003	0.003	0.004	0.004	0.005	0.006	0.007	0.008
360-500	0.001	0.002	0.002	0.002	0.003	0.003	0.004	0.004	0.005	0.006	0.007	0.008
400-525	0.001	0.002	0.002	0.002	0.003	0.003	0.004	0.004	0.005	0.006	0.007	0.008
245-525	0.001	0.002	0.002	0.002	0.003	0.003	0.004	0.004	0.005	0.006	0.007	0.008
400-525	0.001	0.002	0.002	0.002	0.003	0.003	0.004	0.004	0.005	0.006	0.007	0.008
360-500	0.001	0.002	0.002	0.002	0.003	0.003	0.004	0.004	0.005	0.006	0.007	0.008
525-985	0.001	0.002	0.002	0.002	0.003	0.003	0.004	0.004	0.005	0.006	0.007	0.008
-	-	-	-	-	-	-	-	-	-	-	-	-
-	-	-	-	-	-	-	-	-	-	-	-	-
-	-	-	-	-	-	-	-	-	-	-	-	-
-	-	-	-	-	-	-	-	-	-	-	-	-
-	-	-	-	-	-	-	-	-	-	-	-	-
-	-	-	-	-	-	-	-	-	-	-	-	-
-	-	-	-	-	-	-	-	-	-	-	-	-
-	-	-	-	-	-	-	-	-	-	-	-	-
330-1315	0.002	0.002	0.003	0.004	0.004	0.004	0.005	0.005	0.006	0.007	0.009	0.010
-	-	-	-	-	-	-	-	-	-	-	-	-
-	-	-	-	-	-	-	-	-	-	-	-	-
65-265	0.001	0.001	0.001	0.001	0.001	0.001	0.001	0.002	0.002	0.002	0.002	0.002
-	-	-	-	-	-	-	-	-	-	-	-	-
-	-	-	-	-	-	-	-	-	-	-	-	-
-	-	-	-	-	-	-	-	-	-	-	-	-
65-265	0.001	0.001	0.001	0.001	0.001	0.001	0.001	0.002	0.002	0.002	0.002	0.002
180-215	0.001	0.001	0.001	0.001	0.001	0.001	0.001	0.002	0.002	0.002	0.002	0.002
150-180	0.001	0.001	0.001	0.001	0.001	0.001	0.001	0.002	0.002	0.002	0.002	0.002
300-345	0.001	0.001	0.001	0.001	0.001	0.001	0.001	0.002	0.002	0.002	0.002	0.002
180-215	0.001	0.001	0.001	0.001	0.001	0.001	0.001	0.002	0.002	0.002	0.002	0.002

For cutters with long cutting flute reduce feed rate by 40 %.

MACHINING DATA FOR SOLID CARBIDE TOOLS 46Y_RM/LM

ISO	Workpiece Material	Cutting Speed (ft/min)	Feed (in/tooth) - Cutting Diameter											
			Ø0.062	Ø0.078	Ø0.125	Ø0.187	Ø0.250	Ø0.281	Ø0.312	Ø0.359	Ø0.390	Ø0.484	Ø0.562	Ø0.593
P	C15	200-400	0.002	0.002	0.003	0.004	0.004	0.005	0.006	0.006	0.006	0.007	0.007	0.007
	C45, 60	200-300	0.002	0.002	0.002	0.003	0.004	0.004	0.005	0.005	0.006	0.006	0.007	0.007
	Alloyed & treated steel	165-265	0.002	0.002	0.002	0.002	0.002	0.003	0.003	0.003	0.004	0.005	0.005	0.006
	Cast steel	230-300	0.002	0.002	0.002	0.002	0.002	0.003	0.003	0.003	0.004	0.005	0.005	0.006
M	Stainless steel	200-300	0.001	0.001	0.002	0.002	0.002	0.002	0.003	0.003	0.004	0.004	0.005	0.005
K	Cast iron	130-265	0.002	0.002	0.003	0.004	0.004	0.005	0.006	0.006	0.006	0.007	0.007	0.007
N	Aluminum, synthetics, duroplastics, thermoplastics	265-495	0.002	0.002	0.003	0.004	0.004	0.005	0.006	0.006	0.006	0.007	0.007	0.007
		165-660	0.004	0.004	0.005	0.006	0.006	0.007	0.007	0.007	0.007	0.007	0.008	0.008
S	Nickel & Titanium alloys	65-135	0.001	0.001	0.002	0.002	0.005	0.002	0.002	0.002	0.003	0.003	0.003	0.003

DEEP DRILLING APPLICATIONS

APPLICATIONS

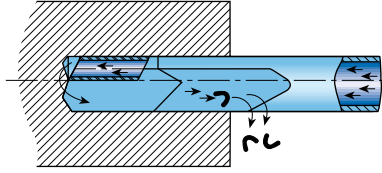

Gun drilling operation in blind hole when chips and coolant are evacuated back through the flute.

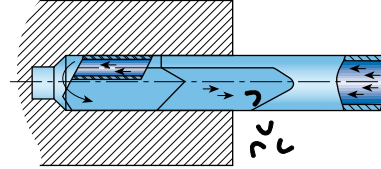

Gun drill boring operation in blind hole when chips and coolant are evacuated back through the flute.

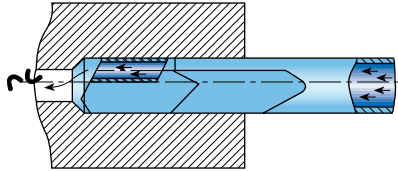

Gun drill boring operation in through hole when chips and coolant are evacuated ahead of the drill tip.

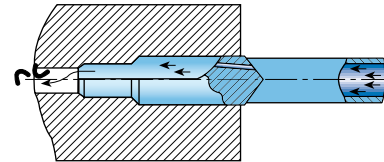

Stepped gun drill boring operation in through hole when chips and coolant are evacuated ahead of the drill tip.

GUN DRILL MACHINING CENTER APPLICATION

DEEP HOLE DRILLING ON CONVENTIONAL MACHINE TOOLS

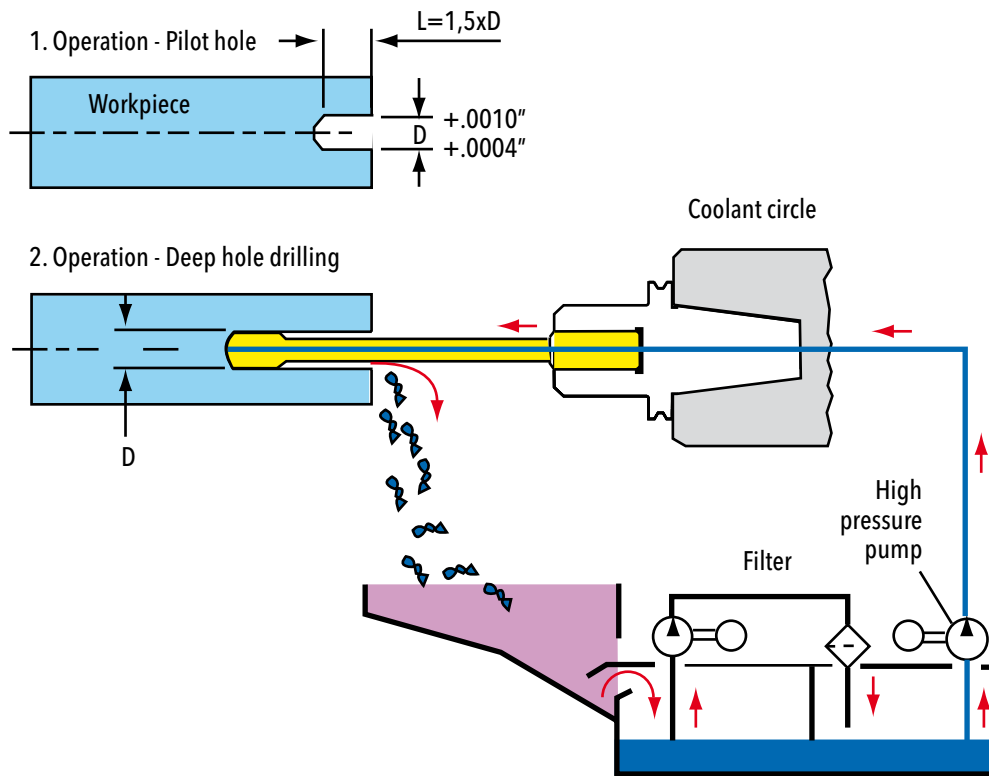

Gun Drills in Machining Centers

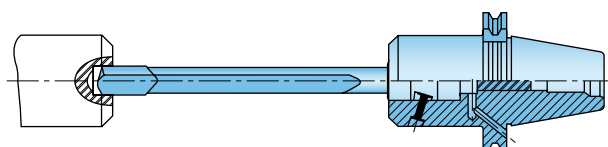

Centering / guiding hole for gun drill operations on machining centers.

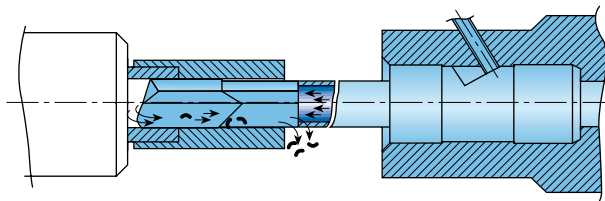

Bushing guide barrel for gun drill stabilizing in machining center.

TROUBLESHOOTING GUIDE

Possible Cause	Drill Problems										Hole Problems						
	Cratering	Built-up edge	Damaged wear pad	Flute bending	Drill heat	Excessive flank wear	Excessive corner wear	Excessive margin wear	Poor drill life	Chipping	Breakage	Curved hole axis	Conical entrance	Runout	Rough surface finish	Undersized	Oversized
Poor clamping								+			+	+		+			+
Insufficient coolant flow					+	+			+		+			+			+
Low coolant pressure									+		+			+	+		
Incorrect coolant type	+	+	+			+	+	+	+					+			
Feed fluctuations		+		+					+	+	+	+					
Feed too high	+	+		+	+	+			+		+			+			+
Feed too low		+							+	+							
Spindle speed too high			+	+	+	+	+	+	+		+						
Spindle speed too low	+	+												+			
Material structure	+	+	+				+	+	+	+	+	+	+				
Material shrinking due to heat			+		+		+	+	+		+			+	+		
Thin wall section of workpiece									+		+						
Misalignment			+	+		+		+	+		+		+				+
Undersized hole			+		+	+		+	+		+			+			
Rough cutting edge finish	+	+					+		+	+	+	+	+				
Built-up edge							+		+		+			+			+
Worn out edge	+	+					+	+	+	+	+	+	+				
Interrupted chip flow			+	+		+		+	+		+			+			+
Flute clearance too small			+		+	+		+	+	+	+			+			
Incorrect drill profile	+	+	+	+			+	+	+		+			+	+	+	+
Incorrect head angles	+	+		+		+	+		+	+	+	+	+	+	+	+	+
Vibrations	+	+	+	+			+		+	+	+	+	+				+
Oversized bushing										+		+					+
Gap between bushing & workpiece						+			+		+			+	+	+	+
Undersized bushing			+	+		+		+	+		+			+			
Loss of coolant pressure		+	+	+	+				+		+			+	+		
High coolant pressure																	+
Overheating coolant	+		+		+	+	+	+	+					+			
Insufficient coolant	+	+	+	+	+				+		+			+			+
Head inside angle excessive wear			+	+					+					+	+		+
Head outside angle excessive wear		+		+			+		+					+	+		
Carbide head too short	+	+	+	+	+	+	+	+	+	+	+	+	+	+	+	+	+
Tool heel drag			+	+	+	+		+	+		+			+	+		+
Worn supporting pads	+		+	+	+		+		+		+			+			+
Tool whip - reverse tool rotation	+	+	+	+			+		+	+	+			+	+		+

GUN DRILL OPERATING GUIDELINES

ISO	Material Number	Cutting Speed (SFM) ø.078 - ø.197	Cutting Speed (SFM) ø.198 - ø.512	Cutting Speed (SFM) ø.513 - ø1.575
P	1	230 - 300	260 - 360	230 - 330
	2	230 - 300	260 - 360	230 - 330
	3	165 - 230	200 - 260	165 - 230
	4	230 - 300	260 - 360	230 - 330
	5	165 - 230	200 - 260	165 - 230
	6	200 - 260	230 - 300	200 - 260
	7	165 - 230	200 - 260	165 - 230
	8	165 - 230	200 - 260	165 - 230
	9	165 - 230	200 - 260	165 - 230
	10	165 - 230	200 - 260	165 - 230
	11	165 - 230	200 - 260	165 - 230
M	12	165 - 230	165 - 230	165 - 230
	13	165 - 230	165 - 230	165 - 230
	14	165 - 230	165 - 230	165 - 230
K	15	200 - 260	230 - 300	230 - 300
	16	200 - 260	230 - 300	230 - 300
	17	200 - 260	230 - 300	230 - 300
	18	200 - 260	230 - 300	230 - 300
	19	200 - 260	230 - 300	230 - 300
	20	200 - 260	230 - 300	230 - 300
N	21	230 - 590	330 - 1000	330 - 1000
	22	230 - 590	330 - 1000	330 - 1000
	23	230 - 590	330 - 1000	330 - 1000
	24	230 - 590	330 - 1000	330 - 1000
	25	230 - 590	330 - 1000	330 - 1000
	26	230 - 390	330 - 520	260 - 530
	27	230 - 390	330 - 520	260 - 530
	28	230 - 390	330 - 520	260 - 530
	29			
	30			
S	31			
	32			
	33			
	34			
	35			
	36			
	37			
H	38			
	39			
	40			
	41			

GUN DRILL COOLANT AND OPERATING GUIDELINES

THE RIGHT COOLANT

Neat Oil

- Oil is preferred over water soluble coolant
- Most conventional gundrilling machines use oil
- Provides superior lubricity, better tool life and surface finish
- No worry about concentration levels
- Does not evaporate

Water Soluable

- Used on most CNC machines

<8% = unacceptable
 10-12% = acceptable
 12-15% = preferred

CUTTING CONDITIONS

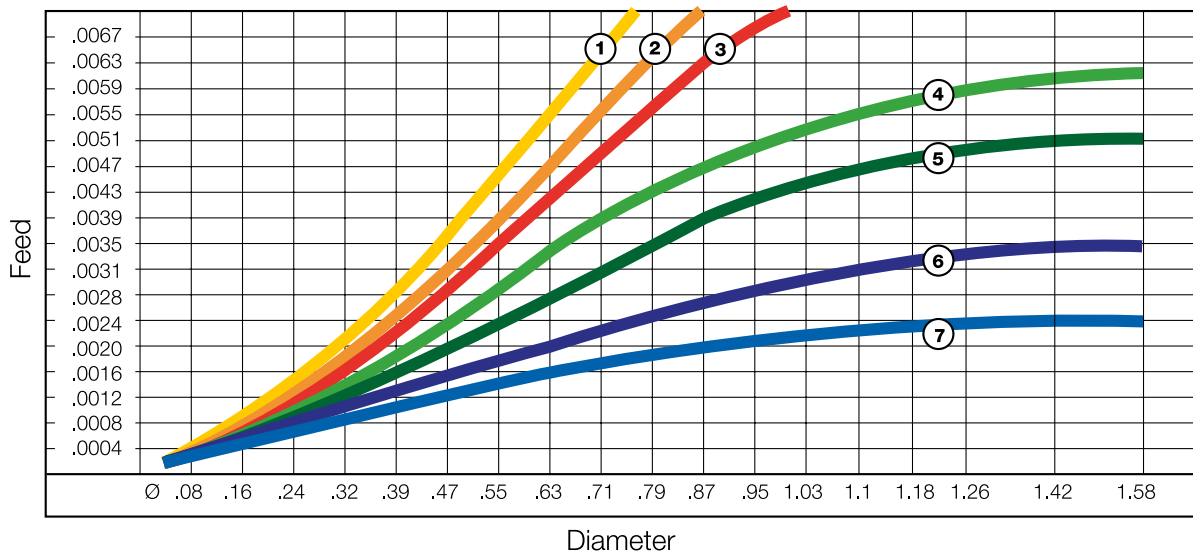

- ① Aluminum Alloy
- ② Grey Cast Iron
- ③ Nodular Cast Iron
- ④ Structural and Free Cutting Steel
- ⑤ High Temper Alloys
- ⑥ Super Alloys
- ⑦ Ferritic and Austenitic Stainless Steel

GUN DRILL OPERATING GUIDELINES

CUTTING CONDITIONS

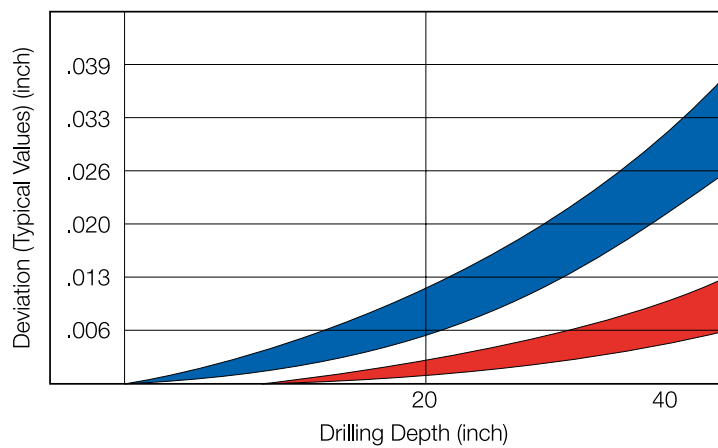
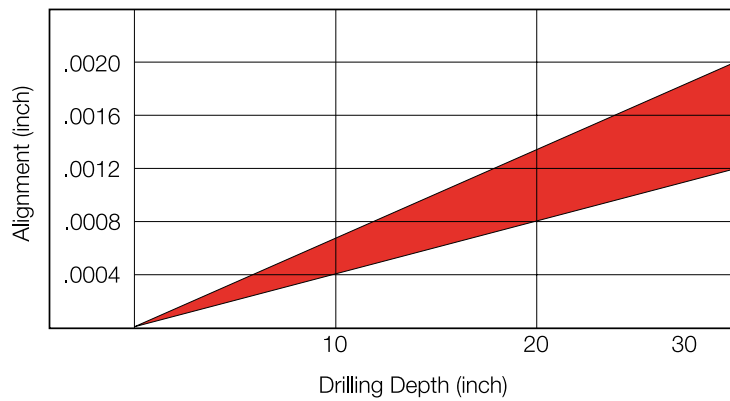

- Stationary workpiece - rotating tool
- Anti clockwise revolving workpiece - rotating tool

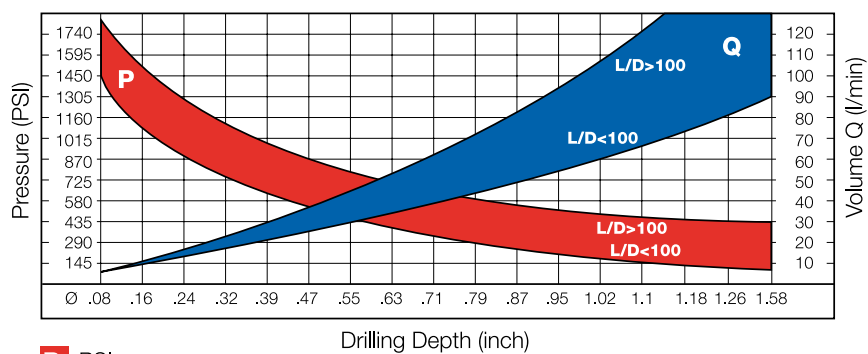

- P PSI
- Q l/min

Single Tube System

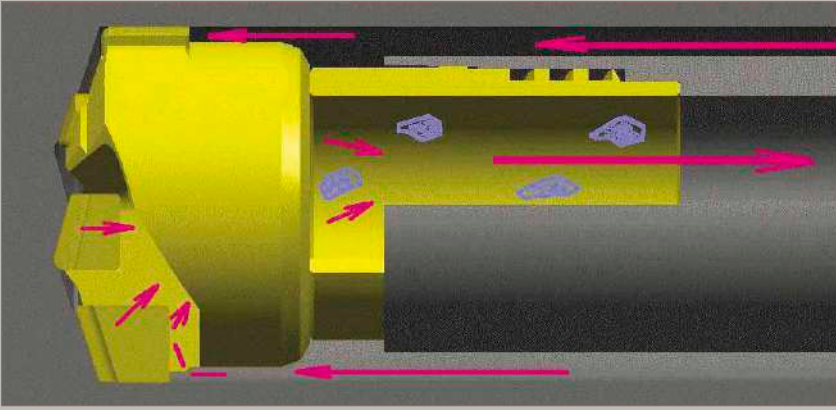

Single Tube System

Double Tube System

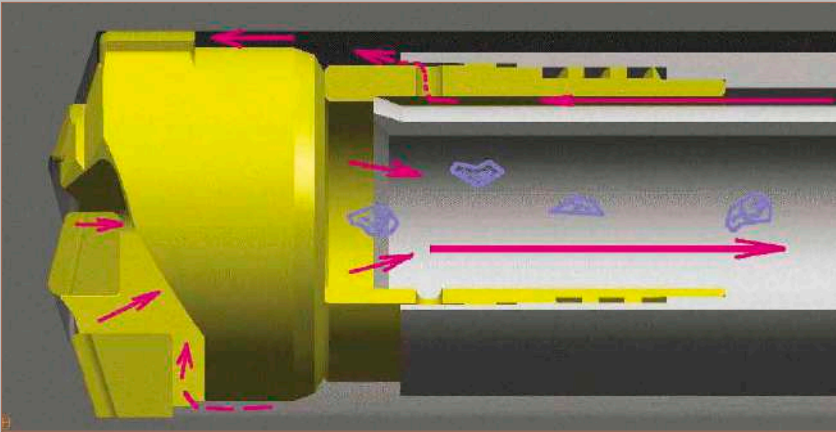

Double Tube System

Setting the diameter when indexing and replacing inserts

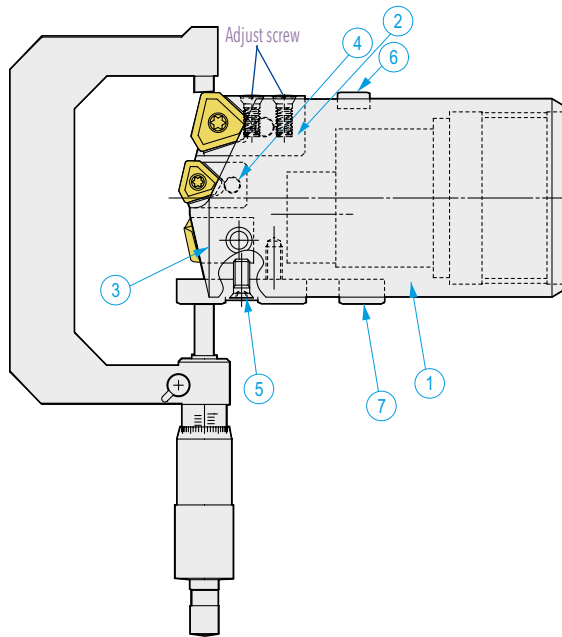

1. Head Shank
2. Outer Cartridge & Lock Screw
3. Inner Cartridge & Lock Screw
4. Center Cartridge & Lock Screw
5. Guide pad & Lock Screw
6. Sub Guide Pad & Lock Screw
7. Guide Pad Protector & Lock Screw

- STEP 1: Slide the Guide Pad (5) forward as shown in the diagram
 - locate the lock screw (5) as shown and tighten
- STEP 2: Loosen the adjust screws and the lock screw of the outer cartridge (2)
- STEP 3: Firmly push the outer cartridge toward the center of the head.
- STEP 4: Slightly tighten the lock screw (2) and adjust the diameter with the two adjust screws.
- STEP 5: When adjustment is completed, firmly tighten the lock screw (2).

Replacing Inserts:

Clean insert pockets carefully and remove even the smallest foreign particles from insert pocket.
 Fasten insert securely in the cartridge and ensure it is completely seated.

Replacing Guide Pad:

Guide pad pockets are precisely produced and are back tapered, therefore the guide pads may be reversed and used again when excessive wear occurs on the corner.

Guide pads are ground to size for immediate use.

Special precaution:

Use the correct spanner when attaching or detaching the drill head from boring bar.
 Use of a pipe wrench or other improper equipment will permanently damage the drill head shank, threading and boring bar threads.

Note:

Although lock screws have been treated with an anti-friction lubricant, please re-apply a suitable anti-friction lubricant regularly to avoid "lock-up".

Applicaton: BTA & BTS Type
 Drill dia: 0.496 - 2.559
 Hole Tolerance: IT9
 Surface finish: Ra 2µm
 Coolant: Neat or soluble oil

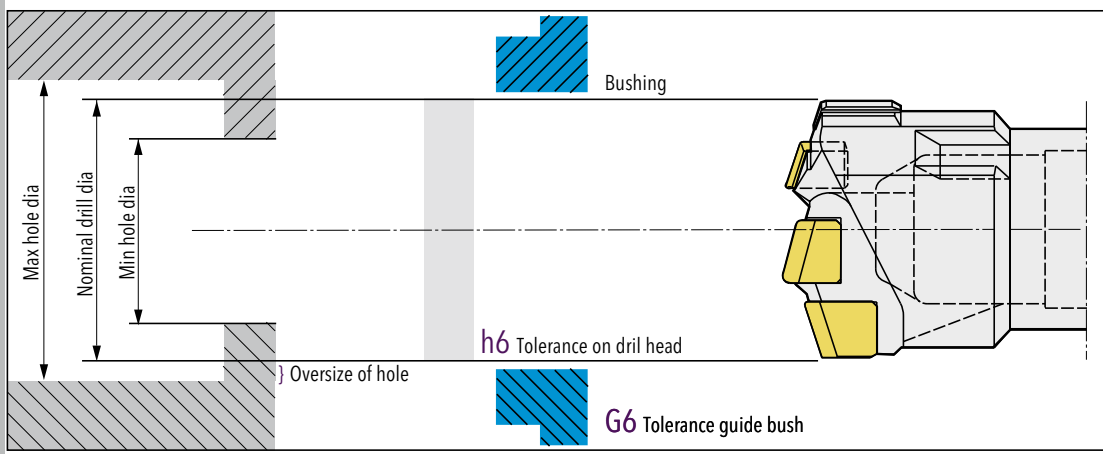

Nominal drill dia = Min hole dia + 2/3 X (Max hole dia - Min hole dia)
 Max hole dia - Tool dia > 0.002
 Finish ground to the desired diameter to tolerance ISO h6.

*Nomally the drill diameter set at the lower limit plus(+) two third(2/3) of tolerance.
 It is important to set the drill diameter -0.002 below the upper limit of the hole diameter

G6 Tolerance (for Guide bush)

Guide bush dia (ø in)	Tolerance (in)
0.394 - 0.709	+0.00024 - +0.00067
0.709 - 1.181	+0.00028 - +0.00079
1.181 - 1.969	+0.00035 - +0.00098
1.969 - 2.559	+0.00039 - +0.00114

h6 Tolerance (for Drill dia)

Drill dia (ø in)	Tolerance (in)
0.394 - 0.709	-0.00024 - 0
0.709 - 1.181	-0.00051 - 0
1.181 - 1.969	-0.00063 - 0
1.969 - 2.559	-0.00075 - 0

ISO	Material	Condition	Tensile Strength Rm(N/mm ²)	Hardness HB	Ground Brazed Solid Drill Heads						Adjustable Solid Drill Heads		
					Cutting Speed	BTA(φ0.496 - φ2.559) , BTS(φ0.315 - φ0.787)					Cutting Speed	TBTA-B(φ0.630 - φ1.122) No Cartridge	
						SFM	0.31 - 0.79 *1	0.22 - 0.79	0.79 - 1.22	1.22 - 1.69		1.69 - 2.56	SFM
P	Non-alloy steel	0.1 - 0.25 %C Annealed	420	125	230-394	0.002 - 0.005	0.003 - 0.006	0.004 - 0.007	0.005 - 0.008	0.006 - 0.012	197-394	0.003 - 0.005	0.004 - 0.006
		0.25 - 0.25 %C Annealed	650	190	230-394	0.002 - 0.005	0.003 - 0.006	0.004 - 0.007	0.005 - 0.008	0.006 - 0.012	197-394	0.003 - 0.005	0.004 - 0.006
	cast steel, free cutting steel	0.25 - 0.25 %C Quenched and tempered	850	250	131-230	0.002 - 0.005	0.003 - 0.006	0.004 - 0.007	0.005 - 0.008	0.006 - 0.012	197-394	0.003 - 0.005	0.004 - 0.006
		0.55 - 0.80 %C pered	750	220	230-394	0.002 - 0.005	0.003 - 0.006	0.004 - 0.007	0.005 - 0.008	0.006 - 0.012	197-394	0.003 - 0.005	0.004 - 0.006
	Low alloy steel and cast steel (less than 5% alloying elements)	0.55 - 0.80 %C Annealed	1000	300	180-328	0.002 - 0.004	0.003 - 0.005	0.004 - 0.006	0.005 - 0.007	0.006 - 0.011	164-328	0.003 - 0.004	0.004 - 0.005
		Quenched and tempered	600	200	230-328	0.002 - 0.005	0.003 - 0.006	0.004 - 0.007	0.005 - 0.008	0.006 - 0.012	164-328	0.003 - 0.004	0.004 - 0.006
		pered	930	275	180-328	0.002 - 0.004	0.003 - 0.005	0.004 - 0.006	0.005 - 0.007	0.006 - 0.011	164-328	0.003 - 0.004	0.004 - 0.005
		Annealed	1000	300	180-328	0.002 - 0.004	0.003 - 0.005	0.004 - 0.006	0.005 - 0.007	0.006 - 0.011	164-328	0.003 - 0.004	0.004 - 0.005
	High alloy steel, cast steel and tool steel.	Quenched and tempered	680	200	164-279	0.002 - 0.005	0.003 - 0.006	0.004 - 0.007	0.005 - 0.008	0.006 - 0.012	197-394	0.003 - 0.005	0.004 - 0.006
		pered	1100	325	180-328	0.002 - 0.004	0.003 - 0.005	0.004 - 0.006	0.005 - 0.007	0.006 - 0.011	164-328	0.003 - 0.004	0.004 - 0.005
M	Stainless steel and cast steel	pered	680	200	197-328	0.002 - 0.005	0.003 - 0.006	0.004 - 0.011	0.005 - 0.012	0.006 - 0.014	131-262	0.003 - 0.005	0.004 - 0.006
		Annealed	820	240	197-328	0.002 - 0.005	0.003 - 0.006	0.004 - 0.011	0.005 - 0.012	0.006 - 0.014	131-262	0.003 - 0.005	0.004 - 0.006
	Quenched and tempered	600	180	197-328	0.002 - 0.005	0.002 - 0.005	0.003 - 0.010	0.004 - 0.011	0.006 - 0.013	98-197	0.002 - 0.004	0.003 - 0.006	
K	Cast iron nodular (GGG)	pered		180	262-328	0.002 - 0.005	0.003 - 0.006	0.004 - 0.007	0.005 - 0.008	0.006 - 0.012	230-328	0.003 - 0.005	0.004 - 0.006
		Ferritic/martensitic		260	262-328	0.002 - 0.005	0.003 - 0.006	0.004 - 0.007	0.005 - 0.008	0.006 - 0.012	230-328	0.003 - 0.005	0.004 - 0.006
	Gray cast iron (GG)	Martensitic		160	197-328	0.002 - 0.005	0.002 - 0.005	0.003 - 0.007	0.004 - 0.008	0.006 - 0.010	164-295	0.002 - 0.005	0.003 - 0.006
		Austenitic		250	197-328	0.002 - 0.005	0.002 - 0.005	0.003 - 0.007	0.004 - 0.008	0.006 - 0.010	164-262	0.002 - 0.005	0.003 - 0.006
	Malleable cast iron	Ferritic/pearlitic		130	164-328	0.002 - 0.005	0.002 - 0.005	0.003 - 0.007	0.004 - 0.008	0.006 - 0.010	164-295	0.002 - 0.005	0.003 - 0.006
Pearlitic			230	164-328	0.002 - 0.005	0.002 - 0.005	0.003 - 0.007	0.004 - 0.008	0.006 - 0.010	164-295	0.002 - 0.005	0.003 - 0.006	
N	Aluminum-wrought alloy	Ferritic		60	213-426	0.002 - 0.005	0.003 - 0.006	0.004 - 0.008	0.006 - 0.010	0.006 - 0.012	197-394	0.003 - 0.005	0.004 - 0.007
		Pearlitic		100	213-328	0.002 - 0.005	0.003 - 0.006	0.004 - 0.008	0.006 - 0.010	0.006 - 0.012	197-295	0.003 - 0.005	0.004 - 0.007
	Aluminum-cast, alloyed	<=12% Si Ferritic		75	213-426	0.002 - 0.005	0.003 - 0.006	0.004 - 0.008	0.006 - 0.010	0.006 - 0.012	197-394	0.003 - 0.005	0.004 - 0.007
		Pearlitic		90	213-426	0.002 - 0.005	0.003 - 0.006	0.004 - 0.008	0.006 - 0.010	0.006 - 0.012	197-394	0.003 - 0.005	0.004 - 0.007
	>12% Si Not cureable		130	213-426	0.002 - 0.005	0.003 - 0.006	0.004 - 0.008	0.006 - 0.010	0.006 - 0.012	197-394	0.003 - 0.005	0.004 - 0.007	
	Copper alloys	>1% Pb Cured		110	213-426	0.002 - 0.005	0.003 - 0.006	0.004 - 0.008	0.006 - 0.010	0.006 - 0.012	197-394	0.003 - 0.005	0.004 - 0.007
		Not cureable		90	213-426	0.002 - 0.005	0.003 - 0.006	0.004 - 0.008	0.006 - 0.010	0.006 - 0.012	197-394	0.003 - 0.005	0.004 - 0.007
Cured		100	213-426	0.002 - 0.005	0.003 - 0.006	0.004 - 0.008	0.006 - 0.010	0.006 - 0.012	197-394	0.003 - 0.005	0.004 - 0.007		
S	High temp. alloys Fe based	High temp.		200	33-164	0.002 - 0.005	0.002 - 0.005	0.003 - 0.006	0.005 - 0.007	0.006 - 0.010	66-164	0.002 - 0.004	0.003 - 0.006
		Free cutting		280	33-164	0.002 - 0.005	0.002 - 0.005	0.003 - 0.006	0.005 - 0.007	0.006 - 0.010	66-164	0.002 - 0.004	0.003 - 0.006
	Super alloys	Ni or Co based		250	33-164	0.002 - 0.005	0.002 - 0.005	0.003 - 0.006	0.005 - 0.007	0.006 - 0.010	66-164	0.002 - 0.004	0.003 - 0.006
		Brass		350	33-164	0.002 - 0.005	0.002 - 0.005	0.003 - 0.006	0.005 - 0.007	0.006 - 0.010	66-164	0.002 - 0.004	0.003 - 0.006
	Electrolitic		320	33-164	0.002 - 0.005	0.002 - 0.005	0.003 - 0.006	0.005 - 0.007	0.006 - 0.010	66-164	0.002 - 0.004	0.003 - 0.006	
	Titanium, Ti alloys	copper	Rm 400		98-164	0.002 - 0.004	0.002 - 0.004	0.003 - 0.005	0.004 - 0.006	0.005 - 0.007	66-164	0.002 - 0.004	0.003 - 0.004
	Alpha+beta alloys	Annealed	Rm 1050		98-164	0.002 - 0.004	0.002 - 0.004	0.003 - 0.005	0.004 - 0.006	0.005 - 0.008	66-164	0.002 - 0.004	0.003 - 0.004
H	Hardened steel	Cured		55 HRc									
		Annealed		60 HRc									
	Chilled cast iron	Cured		400									
	Cast iron	Cast		55 HRc									

ISO	Material	Condition	Tensile Strength Rm(N/mm ²)	Hardness HB	No Cartridge Solid Drill Heads					Ajustable Solid Drill Heads					
					Cutting Speed	TBTA-C(σ 0.984-		TBTA-D(σ 1.181-		Cutting Speed	TBTA3/5/7(σ 1.496 - σ 9.685)				
						Feed Rate f (in/rev)		Feed Rate f (in/rev)			Feed Rate f (in/rev)				
						SFM	0.98 - 1.56	1.56 - 2.09	1.18 - 1.69		1.69 - 2.56	SFM	1.50 - 1.57	1.57 - 2.05	2.05 - 2.52
P	Non-alloy steel, 0.1 - 0.25 %C	Annealed	420	125	230-426	0.004 - 0.008	0.005 - 0.012	0.004 - 0.010	0.005 - 0.014	197-394	0.003 - 0.006	0.004 - 0.008	0.005 - 0.009	0.006 - 0.010	0.007 - 0.012
	cast steel, 0.25 - 0.25 %C	Annealed	650	190	230-426	0.004 - 0.008	0.005 - 0.012	0.004 - 0.010	0.005 - 0.014	197-394	0.003 - 0.006	0.004 - 0.008	0.005 - 0.009	0.006 - 0.010	0.007 - 0.012
	free cutting steel, 0.25 - 0.25 %C	Quenched and tempered	850	250	230-426	0.004 - 0.008	0.005 - 0.012	0.004 - 0.010	0.005 - 0.014	197-394	0.003 - 0.006	0.004 - 0.008	0.005 - 0.009	0.006 - 0.010	0.007 - 0.012
	free cutting steel, 0.55 - 0.80 %C	Annealed	750	220	230-426	0.004 - 0.008	0.005 - 0.012	0.004 - 0.010	0.005 - 0.014	197-394	0.003 - 0.006	0.004 - 0.008	0.005 - 0.009	0.006 - 0.010	0.007 - 0.012
	Low alloy steel and cast steel (less than 5% alloying elements)	Quenched and tempered	1000	300	230-426	0.004 - 0.008	0.005 - 0.012	0.004 - 0.010	0.005 - 0.014	197-394	0.003 - 0.006	0.004 - 0.008	0.005 - 0.009	0.006 - 0.010	0.007 - 0.012
	High alloy steel, cast steel and tool steel.	Annealed	680	200	230-361	0.004 - 0.008	0.005 - 0.012	0.004 - 0.010	0.005 - 0.014	197-328	0.003 - 0.006	0.004 - 0.008	0.005 - 0.009	0.006 - 0.010	0.007 - 0.012
	Stainless steel and cast steel	Quenched and tempered	930	275	197-361	0.004 - 0.008	0.005 - 0.012	0.004 - 0.010	0.005 - 0.014	197-328	0.003 - 0.006	0.004 - 0.008	0.005 - 0.009	0.006 - 0.010	0.007 - 0.012
		Quenched and tempered	1000	300	197-361	0.004 - 0.008	0.005 - 0.012	0.004 - 0.010	0.005 - 0.014	164-328	0.003 - 0.006	0.004 - 0.008	0.005 - 0.009	0.006 - 0.010	0.007 - 0.012
		Quenched and tempered	1200	350	197-361	0.004 - 0.008	0.005 - 0.012	0.004 - 0.010	0.005 - 0.014	168-328	0.003 - 0.006	0.004 - 0.008	0.005 - 0.009	0.006 - 0.010	0.007 - 0.012
		Quenched and tempered	1100	325	230-426	0.004 - 0.008	0.005 - 0.012	0.004 - 0.010	0.005 - 0.014	197-394	0.003 - 0.006	0.004 - 0.008	0.005 - 0.009	0.006 - 0.010	0.007 - 0.012
M	Stainless steel and cast steel	Ferritic/martensitic	680	200	131-361	0.004 - 0.008	0.005 - 0.012	0.004 - 0.010	0.005 - 0.014	197-361	0.003 - 0.006	0.004 - 0.008	0.005 - 0.009	0.006 - 0.010	0.007 - 0.012
		Martensitic	820	240	131-361	0.004 - 0.008	0.005 - 0.012	0.004 - 0.010	0.005 - 0.014	197-361	0.003 - 0.006	0.004 - 0.008	0.005 - 0.009	0.006 - 0.010	0.007 - 0.012
		Austenitic	600	180	131-361	0.004 - 0.008	0.005 - 0.012	0.004 - 0.010	0.005 - 0.014	197-361	0.003 - 0.006	0.004 - 0.008	0.005 - 0.009	0.006 - 0.010	0.007 - 0.012
K	Cast iron nodular (GGG)	Ferritic/pearlitic		180	164-361	0.004 - 0.008	0.005 - 0.012	0.004 - 0.010	0.005 - 0.014	197-328	0.003 - 0.005	0.004 - 0.006	0.005 - 0.007	0.006 - 0.008	0.007 - 0.009
		Pearlitic		260	164-361	0.004 - 0.008	0.005 - 0.012	0.004 - 0.010	0.005 - 0.014	197-328	0.003 - 0.005	0.004 - 0.006	0.005 - 0.007	0.006 - 0.008	0.007 - 0.009
	Gray cast iron (GG)	Ferritic		160	197-361	0.004 - 0.008	0.005 - 0.012	0.004 - 0.010	0.005 - 0.014	197-328	0.003 - 0.005	0.004 - 0.006	0.005 - 0.007	0.006 - 0.008	0.007 - 0.009
		Pearlitic		250	197-361	0.004 - 0.008	0.005 - 0.012	0.004 - 0.010	0.005 - 0.014	197-328	0.003 - 0.005	0.004 - 0.006	0.005 - 0.007	0.006 - 0.008	0.007 - 0.009
	Malleable cast iron	Ferritic		130	230-361	0.004 - 0.008	0.005 - 0.012	0.004 - 0.010	0.005 - 0.014	197-328	0.003 - 0.005	0.004 - 0.006	0.005 - 0.007	0.006 - 0.008	0.007 - 0.009
N	Aluminum-wrought alloy <=12% Si	Not cureable		60	213-426	0.004 - 0.008	0.005 - 0.012	0.004 - 0.010	0.005 - 0.014	197-426	0.003 - 0.008	0.004 - 0.010	0.005 - 0.011	0.006 - 0.012	0.007 - 0.013
		Cured		100	213-426	0.003 - 0.007	0.005 - 0.009	0.003 - 0.009	0.005 - 0.011	197-426	0.003 - 0.008	0.004 - 0.010	0.005 - 0.011	0.006 - 0.012	0.007 - 0.013
	Aluminum-cast, alloyed >12% Si	High temp.		130	213-426	0.003 - 0.007	0.005 - 0.009	0.003 - 0.009	0.005 - 0.011	197-426	0.003 - 0.008	0.004 - 0.010	0.005 - 0.011	0.006 - 0.012	0.007 - 0.013
		Free cutting		110	213-426	0.003 - 0.007	0.005 - 0.009	0.003 - 0.009	0.005 - 0.011	197-426	0.003 - 0.008	0.004 - 0.010	0.005 - 0.011	0.006 - 0.012	0.007 - 0.013
		Brass		90	213-426	0.003 - 0.007	0.005 - 0.009	0.003 - 0.009	0.005 - 0.011	197-426	0.003 - 0.008	0.004 - 0.010	0.005 - 0.011	0.006 - 0.012	0.007 - 0.013
	Copper alloys	Brass		100	213-426	0.003 - 0.007	0.005 - 0.009	0.003 - 0.009	0.005 - 0.011	197-426	0.003 - 0.008	0.004 - 0.010	0.005 - 0.011	0.006 - 0.012	0.007 - 0.013
		Brass		100	213-426	0.003 - 0.007	0.005 - 0.009	0.003 - 0.009	0.005 - 0.011	197-426	0.003 - 0.008	0.004 - 0.010	0.005 - 0.011	0.006 - 0.012	0.007 - 0.013
S	High temp. alloys Fe based	Electrolytic		200	66-164	0.003 - 0.007	0.005 - 0.009	0.003 - 0.009	0.005 - 0.011	66-213	0.003 - 0.006	0.004 - 0.008	0.005 - 0.009	0.006 - 0.010	0.007 - 0.012
		copper		280	66-164	0.003 - 0.007	0.005 - 0.009	0.003 - 0.009	0.005 - 0.011	66-213	0.003 - 0.006	0.004 - 0.008	0.005 - 0.009	0.006 - 0.010	0.007 - 0.012
	Super alloys Ni or Co based	Annealed		250	66-164	0.003 - 0.007	0.005 - 0.009	0.003 - 0.009	0.005 - 0.011	66-213	0.003 - 0.006	0.004 - 0.008	0.005 - 0.009	0.006 - 0.010	0.007 - 0.012
		Cured		350	66-164	0.003 - 0.007	0.005 - 0.009	0.003 - 0.009	0.005 - 0.011	66-213	0.003 - 0.006	0.004 - 0.008	0.005 - 0.009	0.006 - 0.010	0.007 - 0.012
		Annealed		320	66-164	0.003 - 0.007	0.005 - 0.009	0.003 - 0.009	0.005 - 0.011	66-213	0.003 - 0.006	0.004 - 0.008	0.005 - 0.009	0.006 - 0.010	0.007 - 0.012
	Titanium, Alpha+beta alloys	Cured	Rm 400		98-197	0.003 - 0.007	0.005 - 0.009	0.003 - 0.009	0.005 - 0.011	98-328	0.003 - 0.006	0.004 - 0.008	0.005 - 0.009	0.006 - 0.010	0.007 - 0.012
H	Ti alloys			55 HRc											
	Hardened steel	Hardened		60 HRc											
		Hardened		400											
	Chilled cast iron	Cast		55 HRc											

Cast iron Hardened

No.	Problem	Causes	Solutions
1	Chips too small	improper cutting conditions	adjust speed and feed
		chipbreaker or CB radius too small and deep	amend chip breaker
		faulty tool geometry	use correct geometry
		misalignment of shank and spindle	correct misalignment
		material variation	try to adjust by altering speeds and feeds
		loose or oversize guide bushings	change bushing
		poor starting conditions (workpiece not centered)	center workpiece
2	Chips too large	improper cutting conditions	adjust speed and feed
		chipbreaker or CB radius too large and shallow	amend chip breaker
		oversized guide bushing or guide bushing misalignment	correct misalignment or change bushing
3	Erratic chip pattern	lack of uniformity in workpiece material	adjust speeds & feeds or amend CB
		faulty feed mechanism (likely to occur with hydraulic feed system)	consult machine builder or sales engineer
		incorrect carbide grade	check grade charts for guidelines
		chips jamming because of inadequate coolant supply	increase coolant supply
		pressure or incorrect tool geometry	correct tool geometry
		misalignment of shank and spindle	correct misalignment
		excessive vibration due to insufficient workpiece/tool rigidity	contact machine builder or tool manufacturer
		wrong choice of coolant	consult with tool manufacturer
		under or oversized guide bushing	change bushing
4	Stringy chips	incorrect tip geometry	amend chip breaker
		lack of uniformity in workpiece material	adjust with speed & feed or amend CB
		faulty feed mechanism (likely to occur with hydraulic feed system)	consult with machine builder or sales engineer
		cooling contaminated with fine particles	clean coolant
		chemical affinity between workpiece and carbide	check possibility of changing grade
		chipped cutting edge	replace drill
		feedrate too low	increase feed

No.	Problem	Causes	Solutions
5	Carbide tip breakage	dull tool	hone cutting edges if required
		inadequate coolant	check volume and pressure
		contaminated coolant	check coolant
		guide bushing tolerance too tight	replace if necessary or undersize drill
		misalignment of shank and spindle	correct misalignment
		tool geometry error	correct geometry
		material variation	try to adjust by altering speeds and feeds
6	Short tool life	improper speed or feed	adjust accordingly
		incorrect carbide grade	choose proper grade for material
		worn guide bushings	replace guide bushings
		excessively warm coolant	check coolant temperature & system
		incorrect cutting fluid	replace if possible
		misalignment of shank and spindle	correct misalignment
		tool geometry error	correct geometry
		material variation	try to adjust by altering speeds and feeds
7	Poor surface finish	misalignment	check and adjust
		inadequate dampening of shank causing vibration	provide vibration dampers
		CB too far above or below center line	correct chip breaker
		faulty cutter or guide pad geometry	correct geometry
		misalignment between workpiece and drill	correct misalignment
		workpiece deflection	improve clamping and rigidity
		excessive vibration	contact tool or machine manufacturer
		tool geometry error	correct geometry
		cutting speed too low	increase cutting speed
		feed too light especially in hardened material	increase feed
		uneven feed	correct feed mechanism
		none of above or unsolved problems	contact tool manufacturer

■ Coolant Volume Gal/min
— Coolant Pressure PSI

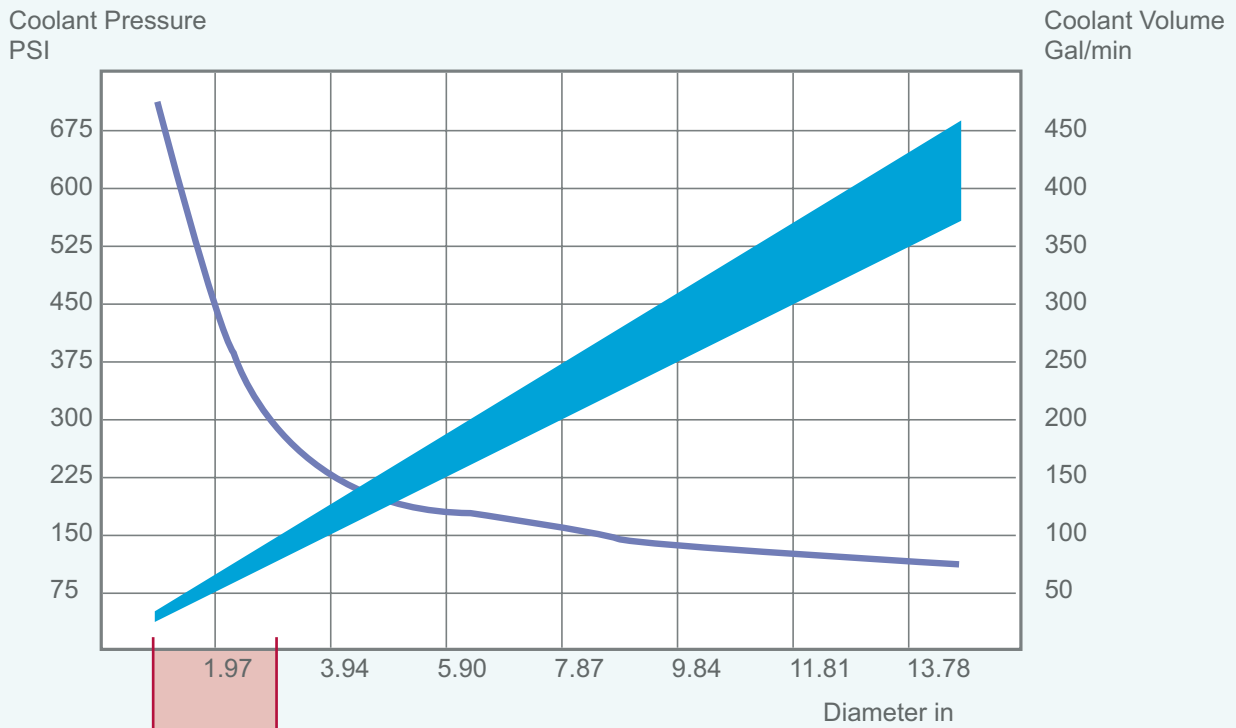

Small Diameter

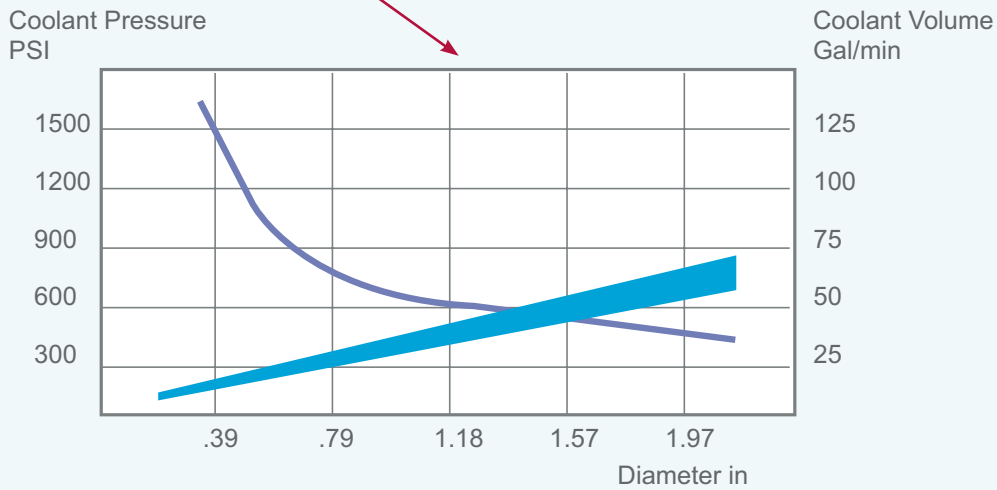

■ Coolant Volume Gal/min
— Coolant Pressure PSI

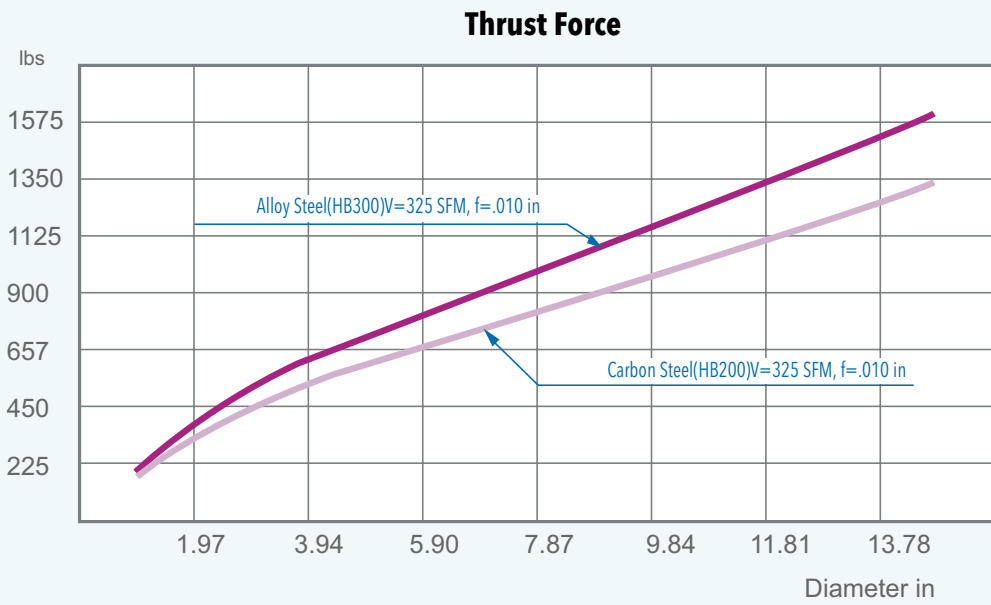
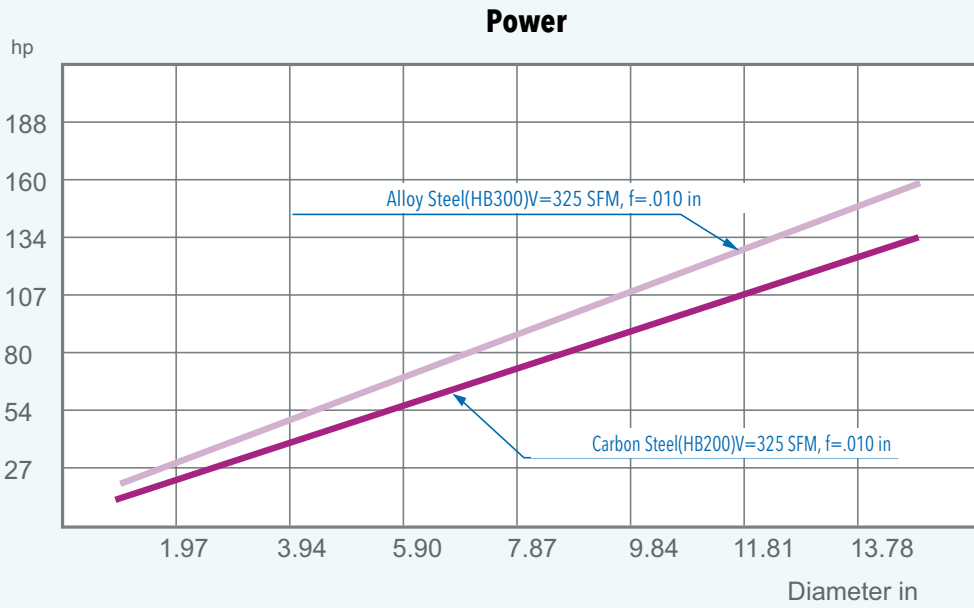



INNO-FIT & TOP-ON TOOLHOLDERS

HSK TOOLHOLDERS

CAT TOOLHOLDERS

BT TOOLHOLDERS

SPECIAL ADAPTIONS & ACCESSORIES

TURNING

THREADING

T-CLAMP

T-CAP

Ingersoll



CUTTING TOOLS
CUTTING TOOLS

INNO-FIT & TOP-ON TOOLHOLDERS.

Cutting Tools





Member IMC Group
Ingersoll
Cutting Tools

INNO-FIT & TOP-ON TOOLHOLDERS.

Description	Product Line	Page	
	SPINDLE ADAPTOR C40Z4SA, HSKA63		726
	FACE MILL ADAPTOR Z4SM, Z5SM		727
	EXTENSIONS Z4Z4, Z5Z5		728
	ADAPTOR Z5Z4		728
	ADAPTOR Z4MOD		729
	STRAIGHT SHANKS STEEL W*MOD, S*MOD		730
	CONICAL SHANKS STEEL W*MOD, S*MOD		731
	SHANKS CARBIDE S*MOD		732
	HSK-63A STANDARD HOLDERS SCREW-IN TOOL CONNECTION		733
	ANSI STANDARD: 40-TAPER HOLDERS SCREW-IN TOOL CONNECTION CA40MOD		734
	ANSI STANDARD: 50-TAPER HOLDERS SCREW-IN TOOL CONNECTION CA50ODP		735
	EXTENSIONS MOD*MOD*		736

Ingersoll

	Description	Product Line	Page
	REDUCERS MOD*MOD*		737



INNOFIT™ SERIES C40Z4SA, HSKA63

SPINDLE ADAPTOR

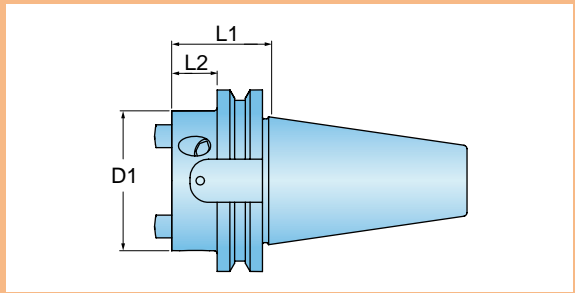
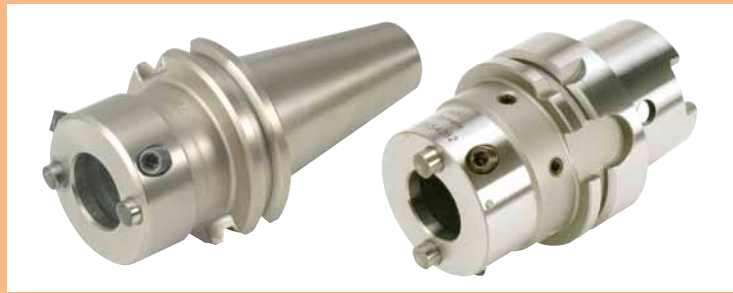

Designation	D1 Nominal Diameter	Adaption	Innofit Adaption	L1 Extension Length	L2 Projection Length
C40Z4SA-13	1.93	#40 V-Flange	SK40	1.38	0.63
C40Z4SA-21	1.93	#40 V-Flange	SK40	2.13	1.38
HSKA63Z4SA062	1.93	HSK-63-A	SK40	2.44	1.38
C50Z5SA-21	3.07	ICT #50 V-Flange	SK50	2.13	1.38

FACE MILL ADAPTOR

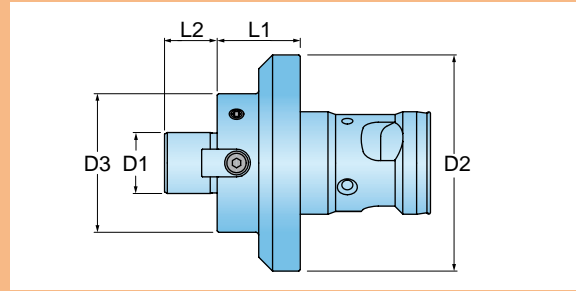

Designation	D1 Nominal Diameter	Adaption	D2 Flange Diameter	L1 Extension Length	L2 Pilot Height	Keys	D3 Mating Diameter
Z4SM05SA-10	0.50	SK40	1.93	1.00	0.56	0.250	1.44
Z4SM07SA-10	0.75	SK40	1.93	1.00	0.68	0.312	1.75
Z5SM07SA-12	0.75	SK50	3.07	1.25	0.68	0.312	1.75
Z4SM10SA-12	1.00	SK40	1.93	1.25	0.68	0.375	2.75
Z5SM10SA-12	1.00	SK50	3.07	1.25	0.68	0.375	2.75
Z5SM12SA-12	1.25	SK50	3.07	1.25	0.68	0.500	2.75
Z5SM15SA-12	1.50	SK50	3.07	1.25	0.94	0.625	3.81

INNOFIT™ SERIES Z4Z4, Z5Z5

EXTENSIONS

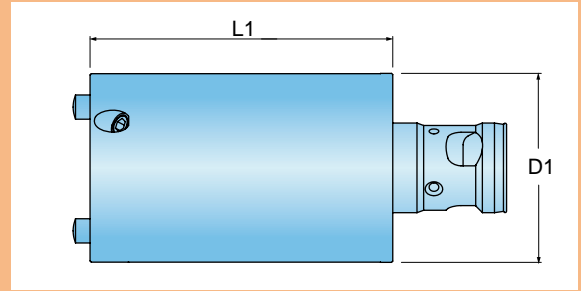

Designation	D1 Nominal Diameter	Adaption	L1 Extension Length
Z4Z4SA050	1.93	SK40	1.97
Z4Z4SA075	1.93	SK40	2.95
Z4Z4SA100	1.93	SK40	3.94
Z5Z5SA075	3.07	SK50	2.95
Z5Z5SA100	3.07	SK50	3.94
Z5Z5SA125	3.07	SK50	4.93

INNOFIT™ SERIES Z5Z4

ADAPTOR

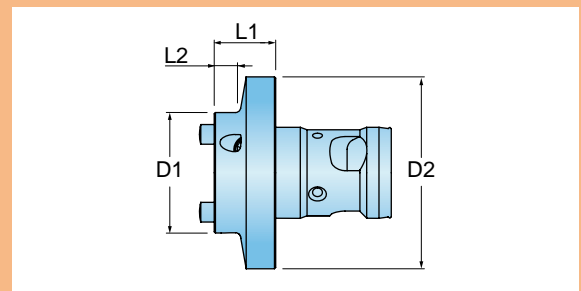

Designation	D1 Nominal Diameter	Adaption	L1 Extension Length	L2 Projection Length	D2 Flange Diameter
Z5Z4SA025	1.93	SK50, SK40	0.985	0.355	3.07
Z5Z4SA050	1.93	SK50, SK40	1.970	1.340	3.07
Z5Z4SA075	1.93	SK50, SK40	2.955	2.320	3.07
Z5Z4SA100	1.93	SK50, SK40	3.940	3.310	3.07

ADAPTOR



Coolant

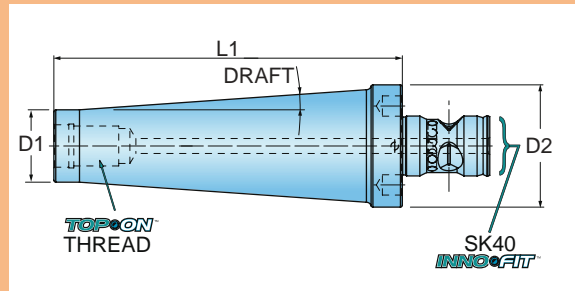

Designation	D1 Nominal Diameter	Adaption	L1 Extension Length	L2 Projection Length	D2 Flange Diameter
Z5Z4SA025	1.93	SK50, SK40	0.985	0.355	3.07
Z5Z4SA050	1.93	SK50, SK40	1.970	1.340	3.07
Z5Z4SA075	1.93	SK50, SK40	2.955	2.320	3.07
Z5Z4SA100	1.93	SK50, SK40	3.940	3.310	3.07

STRAIGHT SHANKS STEEL

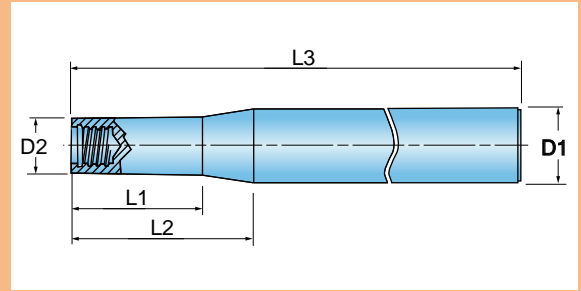

Designation	T1 Internal Thread	D1 Shank Diameter	D2 Mating Diameter	L1 Projection Length	L2 Extension Length	L3 Overall Length
W050MOD06SA-22	M06	.500" Weldon	0.46	2.20	2.25	4.00
S062MOD08SK-30	M08	.625" Cylindrical	0.51	1.00	1.09	3.00
WB062MOD08SK-50	M08	.625" Weldon	0.51	3.00	3.09	5.00
S075MOD10SK-30	M10	.750" Cylindrical	0.71	1.00	1.09	3.00
WB075MOD10SK-50	M10	.750" Weldon	0.71	3.00	3.09	5.00
S100MOD12SA-80	M12	1.000" Cylindrical	0.82	2.80	5.75	8.00
S125MOD16SK-90	M16	1.250" Weldon	1.14	2.00	6.75	9.00
WB125MOD16SK-40	M16	1.250" Cylindrical	1.14	1.37	1.75	4.00

CONICAL SHANKS STEEL

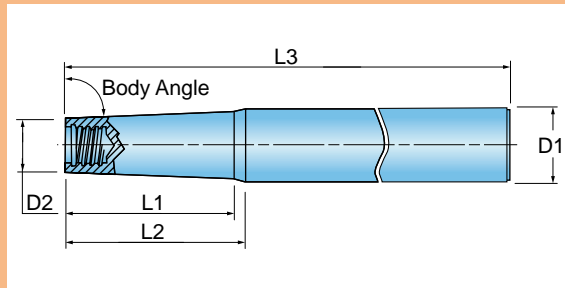

Designation	T1 Internal Thread	D1 Shank Diameter	D2 Mating Diameter	L1 Projection Length	L2 Extension Length	L3 Overall Length	Angle
W050MOD06SK-24	M06	.500" Cylindrical	0.39	2.36	-	4.00	1.2
S075MOD08SK-65	M08	.500" Cylindrical	0.51	2.62	4.50	6.50	3.0
S100MOD10SK-80	M10	1.000" Cylindrical	0.71	2.25	5.75	8.00	3.5
S125MOD12SK-80	M12	1.250" Cylindrical	0.82	3.00	5.75	8.00	4.0
WB100MOD12SK-35	M12	1.000" Weldon	0.82	1.18	1.25	3.50	4.0

SHANKS CARBIDE

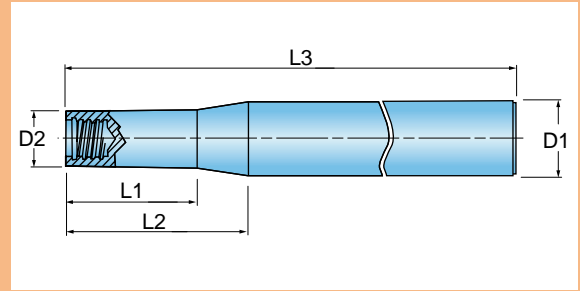

Designation	T1 Internal Thread	D1 Shank Diameter	D2 Mating Diameter	L1 Projection Length	L2 Extension Length	L3 Overall Length	Angle
S050MOD06CA-40	M06	.500" Cylindrical	0.46	1.55	1.60	3.30	-
S050MOD06CA-50	M06	.500" Cylindrical	0.46	3.15	3.15	5.00	-
S062MOD08CK-40	M08	.625" Cylindrical	0.51	2.06	2.09	4.00	1.5
S062MOD08CK-55	M08	.625" Cylindrical	0.51	3.30	3.59	5.50	1.0
S062MOD08CK-70	M08	.625" Cylindrical	0.51	5.03	5.09	7.00	1.0
S075MOD10CA-40	M10	.750" Cylindrical	0.71	1.97	2.00	4.00	-
S075MOD10CA-60	M10	.750" Cylindrical	0.71	3.90	4.00	6.00	-
S075MOD10CA-80	M10	.750" Cylindrical	0.71	5.90	6.00	8.00	-
S100MOD10CK-85	M10	1.000" Cylindrical	0.71	5.70	5.75	8.50	1.5
S100MOD12CA-65	M12	1.000" Cylindrical	0.82	-	4.25	6.50	-
S100MOD12CA-85	M12	1.000" Cylindrical	0.82	-	6.25	8.50	-
S100MOD12CK-45	M12	1.000" Cylindrical	0.82	2.22	2.25	4.50	1.5
S100MOD12CK-65	M12	1.000" Cylindrical	0.82	4.22	4.25	6.50	1.0
S100MOD12CK-85	M12	1.000" Cylindrical	0.82	6.20	6.25	8.50	1.0
S125MOD16CK-90	M16	1.250" Cylindrical	1.14	6.70	6.75	9.00	0.5

HSK-63A STANDARD HOLDERS
SCREW-IN TOOL CONNECTION

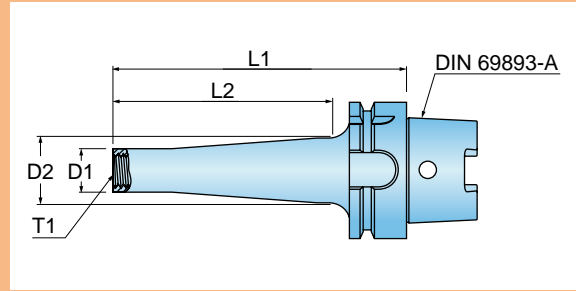

Designation	T1 Internal Thread	D1 Connection Diameter	D2 Projection Diameter	L1 Extension Length	L2 Projection Length
HSKA63MOD08SK059-G2	M08	0.510	0.520	2.32	0.98
HSKA63MOD08SK084-G2	M08	0.510	0.787	3.31	1.97
HSKA63MOD08SK109-G2	M08	0.510	0.905	4.29	2.95
HSKA63MOD08SK134-G2	M08	0.510	0.984	5.28	3.94
HSKA63MOD08SK184-G2	M08	0.510	0.984	7.24	5.91
HSKA63MOD10SK059-G2	M10	0.710	0.767	2.32	0.98
HSKA63MOD10SK084-G2	M10	0.710	0.945	3.31	1.97
HSKA63MOD10SK109-G2	M10	0.710	1.102	4.29	2.95
HSKA63MOD10SK134-G2	M10	0.710	1.126	5.28	3.94
HSKA63MOD10SK184-G2	M10	0.710	1.260	7.24	5.91
HSKA63MOD12SK059-G2	M12	0.830	0.925	2.32	0.98
HSKA63MOD12SK084-G2	M12	0.830	0.945	3.31	1.97
HSKA63MOD12SK109-G2	M12	0.830	1.220	4.29	2.95
HSKA63MOD12SK134-G2	M12	0.830	1.417	5.28	3.94
HSKA63MOD12SK184-G2	M12	0.830	1.417	7.24	5.91
HSKA63MOD16SK059-G2	M16	1.140	1.161	2.32	0.98
HSKA63MOD16SK084-G2	M16	1.140	1.339	3.31	1.97
HSKA63MOD16SK109-G2	M16	1.140	1.457	4.29	2.95
HSKA63MOD16SK134-G2	M16	1.140	1.615	5.28	3.94
HSKA63MOD16SK184-G2	M16	1.140	1.615	7.24	5.91

TOPCON™ SERIES CA40MOD

ANSI STANDARD: 40-TAPER HOLDERS
SCREW-IN TOOL CONNECTION

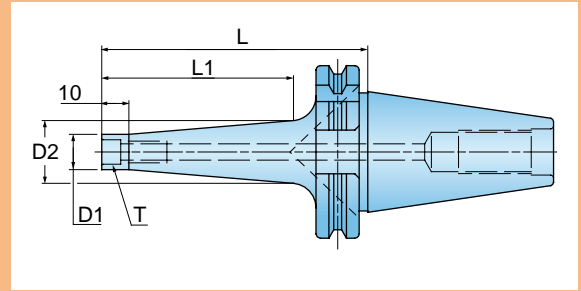

Designation	T1 Internal Thread	D1 Connection Diameter	D2 Projection Diameter	L1 Extension Length	L2 Projection Length	Retention Knob
CA40MOD08SK-020	M08	0.510	0.580	2.00	0.63	Not Furnished
CA40MOD08SK-040	M08	0.510	0.790	4.00	2.63	Not Furnished
CA40MOD10SK-020	M10	0.710	0.780	2.00	0.63	Not Furnished
CA40MOD10SK-040	M10	0.710	0.990	4.00	2.63	Not Furnished
CA40MOD12SK-040	M12	0.830	1.110	4.00	2.63	Not Furnished
CA40MOD12SK-060	M12	0.830	1.310	6.00	4.63	Not Furnished
CA40MOD16SK-040	M16	1.140	1.420	4.00	2.63	Not Furnished
CA40MOD16SK-060	M16	1.140	1.620	6.00	4.63	Not Furnished

ANSI STANDARD: 50-TAPER HOLDERS
SCREW-IN TOOL CONNECTION

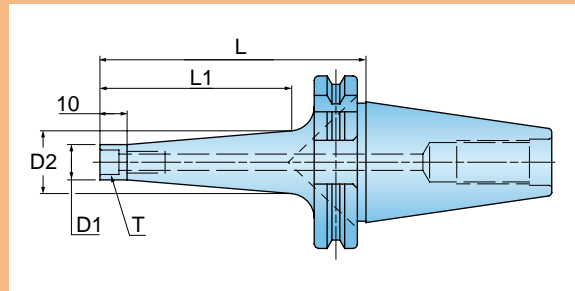

Designation	T1 Internal Thread	D1 Connection Diameter	D2 Projection Diameter	L1 Extension Length	L2 Projection Length	Retention Knob
CAT500DPM8X5.000	M08	0.510	0.910	5.00	3.56	Not Furnished
CAT500DPM10X3.000	M10	0.710	0.710	3.00	1.56	Not Furnished
CAT500DPM10X7.000	M10	0.710	1.100	7.00	5.56	Not Furnished
CAT500DPM12X3.000	M12	0.830	0.830	3.00	1.56	Not Furnished
CAT500DPM12X7.000	M12	0.830	1.220	7.00	5.56	Not Furnished
CAT500DPM16X3.000	M16	1.140	1.140	3.00	1.56	Not Furnished
CAT500DPM16X7.000	M16	1.140	1.340	7.00	5.56	Not Furnished

EXTENSIONS

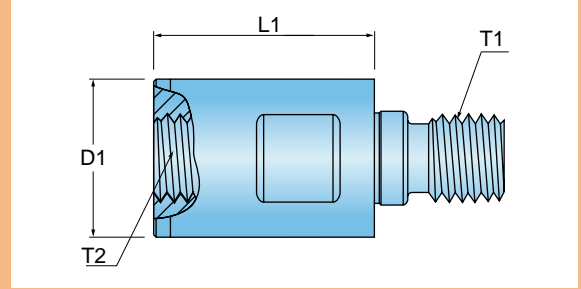

Designation	T1 External Thread	T2 Internal Thread	D1 Connection Dia. mm (in)	L1 Extension Length mm (in)	Wrench Size
MOD08MOD08SA030	M08	M08	13mm (0.51")	30mm (1.181")	10mm
MOD10MOD10SA035	M10	M10	18mm (0.71")	35mm (1.378")	15mm
MOD12MOD12SA040	M12	M12	21mm (0.82")	40mm (1.575")	18mm
MOD16MOD16SA040	M16	M16	29mm (1.14")	40mm (1.575")	25mm

REDUCERS

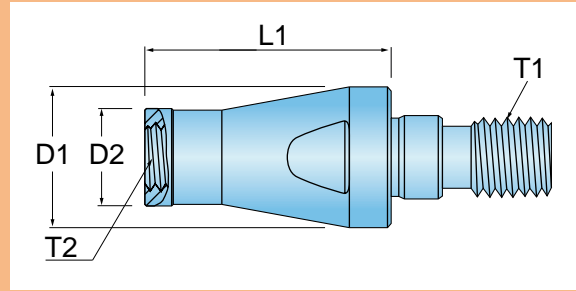

Designation	T1 External Thread	T2 Internal Thread	D1 Connection Dia. mm (in)	D2 Projection Dia. mm (in)	L1 Extension Length mm (in)	Wrench Size
MOD08MOD06SK030	M08	M06	13mm (0.051")	9.7mm (0.38")	30mm (1.18")	10mm
MOD10MOD08SK040	M10	M08	18mm (0.71")	13mm (0.51")	40mm (1.57")	15mm
MOD12MOD10SK045	M12	M10	21mm (0.82")	18mm (0.71")	45mm (1.77")	18mm
MOD16MOD12SK050	M16	M12	29mm (1.14")	21mm (0.82")	50mm (1.96")	25mm

Ingersoll



CUTTING TOOLS

HSK TOOLHOLDERS.

Cutting Tools



Member IMC Group
Ingersoll
Cutting Tools

HSK TOOLHOLDERS.

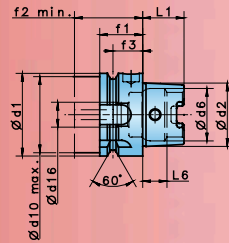

HSK-A	d ₁ (mm)	d ₂ (mm)	d ₆ (mm)	d _{10 max.} (mm)	d ₁₀ (mm)	f ₁ (mm)	f _{2 min.} (mm)	f ₃ (mm)	L ₁ (mm)	L ₆ (mm)
50	50	38	29	42	M16	26	42	18	25	14,13
63	63	48	37	53	M18	26	42	18	32	18,13
80	80	60	46	67	M20	26	42	18	40	22,85
100	100	75	58	85	M24	29	45	20	50	28,56

	Description	Series	Page
	Standard Toolholder - Form A Standard, Metric	HSK-A40/50/63/80/100	744
	Standard Toolholder - Form E - Metric	HSK-E32/40/50/63	745
	Standard Toolholder - Form F Standard, Metric	SHK-F63	746
	Collet Chuck, Metric	HSK-E32/40/50/63-ER16/20/25/32	747
	Mini Collet Chuck, Metric	HSK-A50/63/100-ER16/20	748
	Collet Chuck, Metric	HSK-A40/50/63/100-ER16/20	749
	Collet Chuck, Metric	HSK-A40/50/63/100-ER25/32/40/50	750
	Collet Chuck, Metric	HSK-FM63-ER16	751

	Description	Series	Page
	Collet Chuck, Metric for Makino Mag3, Mag4, and V77 Machine Models	HSK-FM63-ER32/40	752
	End Mill Holder	HSK-A50/63/100-EM3/16, 1/4, 3/8, 1/2, 5/8, 3/4, 7/8, 1, 1 1/4, 1 1/2	753
	Thermal Shrink Holder	HSK-A63/100-SRKIN1/4, 5/16, 3/8, 7/16, 1/2, 5/8, 3/4, 7/8, 1, 1 1/4	754
	Thermal Shrink Holder - Metric	HSK-A63-SRKIN 6/8/10/12/14/16/18/20/25/32	755
	Thermal Shrink Holder - Metric	HSK-A100-SRKIN6/8/10/12/14/16/18/20/25/32	756
	Thermal Shrink Holder for Makino Mag3, Mag4, and V77 Machine Models	HSK-FM63-SRKIN1/4, 5/16, 3/8, 1/2, 5/8, 3/4, 1	757
	Thermal Shrink Holder for Makino Mag3, Mag4, and V77 Machine Models - Metric	HSK-FM63-SRKIN 6/8/10/12/14/16/18/20/25/32	758
	Thermal Shrink Holder	HSK-E32/40/50/63-SRK	759
	Thermal Shrink Holder - Metric	HSK-E32/40/50/63-SRK	760
	Thermal Shrink Holder	HSK-A63-SRK1/8, 3/16, 1/4, 5/16, 3/8, 7/16, 1/2	761
	Thermal Shrink Holder - Metric	HSK-A63-SRK3/4/5/6/8/10/12	762
	Shell Mill Adapter	HSK-E32/40/50/63	763

HSK TOOLHOLDERS.

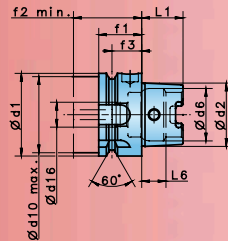

HSK-A	d ₁ (mm)	d ₂ (mm)	d ₆ (mm)	d _{10 max} (mm)	d ₁₆ (mm)	f ₁ (mm)	f _{2 min} (mm)	f ₃ (mm)	L ₁ (mm)	L ₆ (mm)
50	50	38	29	42	M16	26	42	18	25	14,13
63	63	48	37	53	M18	26	42	18	32	18,13
80	80	60	46	67	M20	26	42	18	40	22,85
100	100	75	58	85	M24	29	45	20	50	28,56

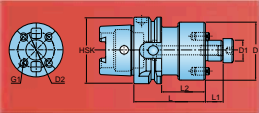
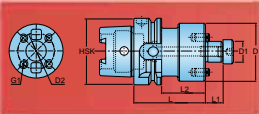
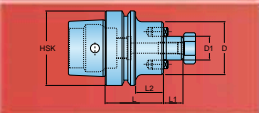
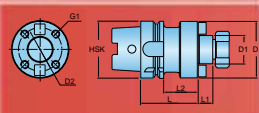
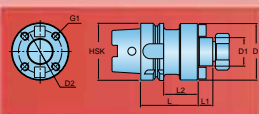
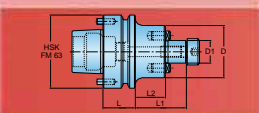
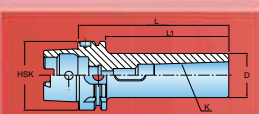
	Description	Series	Page
	Shell Mill Adapter	HSK-A50/63/100-SEM3/4, 1, 1 1/4, 1 1/2, 2	764
	Face Mill Holder	HSK-A100-FM2 1/2	765
	Shell Mill Adapter - Metric	HSK-E32/40/50/63-SEM16/22	766
	Shell Mill Adapter, Metric	HSK-A40/50/63/100-SEM16/22/27/32/40/50	767
	Face Mill Holder - Metric	HSK-A100-FM60	768
	Shell Mill Adapter for Makino Mag3, Mag4, and V77 Machine Models	HSK-FM63-SEM3/4, 1	769
	Shell Mill Adapter for Makino Mag3, Mag4, and V77 Machine Models - Metric	HSK-FM63-SEM22/27/32	770
	Morse Taper Adapter - Metric	HSK-A50/63/100-MT1/2/3/4/5	771

Description	Series	Page	
	Short ER Collet Chuck - Metric	HSK-A63-ER32/40SHORT	772
	Blank - Metric	HSK-A50/63/100-B16MN	773



HSK - STANDARD TOOLHOLDER DIN69893 FORM A STANDARD - METRIC

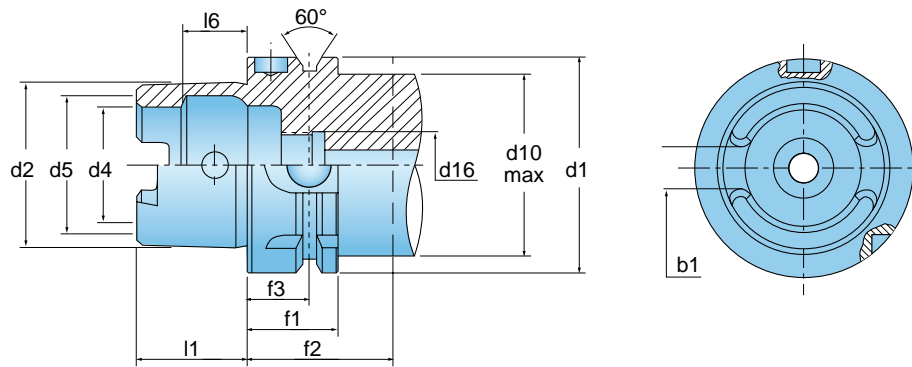

HSK-A	d1	d2	d4	d5	d10	d16	l1	l6	b1	f1	f2	f3
40	40	30	21	25.5	34	M12x1	20	11.42	8.05	20	35	16
50	50	38	26	32.0	42	M16x1	25	14.13	10.54	26	42	18
63	63	48	34	40.0	53	M18x1	32	18.13	12.54	26	42	18
80	80	60	42	50.0	67	M20x1.5	40	22.85	16.04	26	42	18
100	100	75	53	63.0	85	M24x1.5	50	28.56	20.02	29	45	20

HSK - DIN69893 FORM E - METRIC

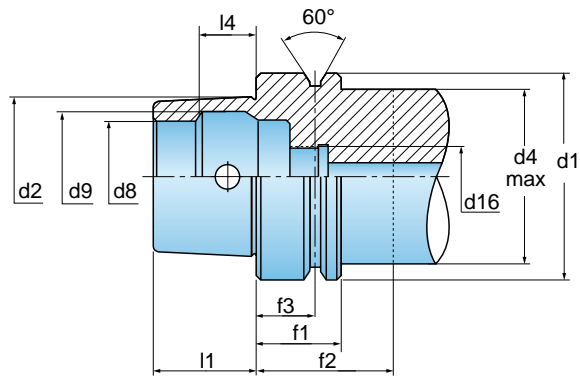

HSK-E	d1	d2	d4	d8	d9	d16	l1	l4	f1	f2	f3
32*	32	24	26	17	19.0	M10X1	16	8.92	20	35	16
40	40	30	34	21	25.5	M12X1	20	11.42	20	35	16
50	50	38	42	26	32.0	M16X1	25	14.13	26	42	18
63	63	48	53	34	40.0	M18X1	32	18.13	26	42	18

* Without cross hole.



HSK - STANDARD TOOLHOLDER DIN69893 FORM F STANDARD - METRIC

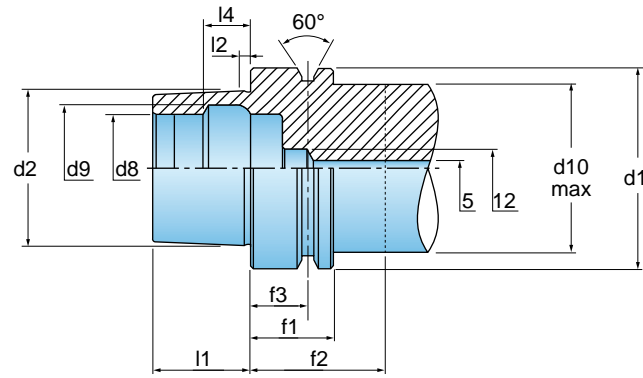

HSK-F	d1	d2	d4	d8	d9	l1	l2	l4	f1	f2	f3
63	63	38	53	26	32	25	5	14.13	26	42	18

HSK - ER COLLET CHUCK - METRIC

Taper Size
HSK-E 32, 40, 50 & 63

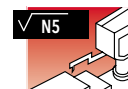
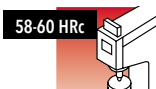
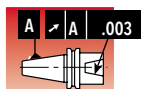

G2.5
40,000 RPM

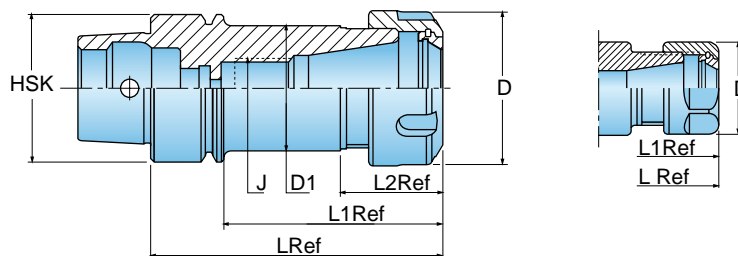

Designation	HSK-E	Range	D	D1	L	L1	L2	J
HSK E 32 ER16 X 60	32	0.5-10	28	22.4	60	40	21.5	—
HSK E 32 ER20 X 60	32	1-13	34	25.4	60	40	26	—
HSK E 32 ER25 X 65	32	1-16	42	25.8	65	45	30	—
HSK E 40 ER16 X 60	40	0.5-10	28	—	60	40	—	—
HSK E 40 ER16 X 80	40	0.5-10	28	—	80	60	—	M10
HSK E 40 ER20 X 80	40	1-13	34	—	80	60	—	M12
HSK E 40 ER25 X 80	40	1-16	42	34.0	80	60	28	M18X1.5
HSK E 40 ER32 X 80	40	2-20	50	40.1	80	60	31	M22X1.5
HSK E 50 ER16 X 80*	50	0.5-10	28	—	80	54	—	M10
HSK E 50 ER16 X 100*	50	0.5-10	28	—	100	74	—	M10
HSK E 50 ER16 X 100M*(1)	50	0.5-10	22	—	100	74	—	M10
HSK E 50 ER20 X 80*	50	1-13	34	—	80	54	—	M10
HSK E 50 ER25 X 80*	50	1-16	42	32.4	80	54	28	—
HSK E 50 ER32 X 80*	50	2-20	50	40.4	80	54	31	—
HSK E 50 ER32 X 100*	50	2-20	50	40.4	100	74	31	M22X1.5
HSK E 63 ER16 X 80*	63	0.5-10	28	—	80	54	—	M10
HSK E 63 ER16 X 100*	63	0.5-10	28	—	100	74	—	M10
HSK E 63 ER32 X 80**	63	2-20	50	40.4	80	54	31	—
HSK E 63 ER32 X 100**	63	2-20	50	—	100	75	—	M22X1.5

*Balance to G2.5 35,000RPM.
**Balance to G2.5 30,000 RPM.
(1)Equipped with nut ER 16 MINI.



HSK - ER MINI COLLET CHUCK - METRIC

Taper Size
HSK-A 50, 63 and 100

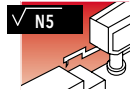
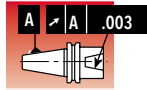

G2.5
20,000 RPM

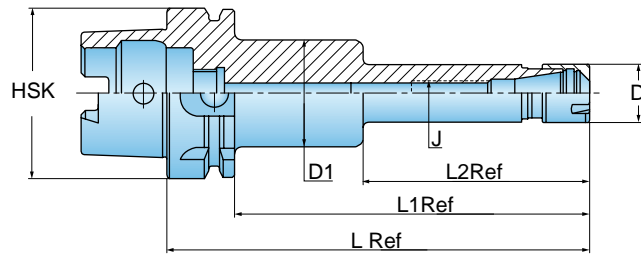

Designation	HSK-A	Range	D	D1	L	L1	L2	J
HSK A 50 ER16X100 M	50	0.5-10	22		100	74		M10
HSK A 50 ER16X120 M	50	0.5-10	22		120	94		M10
HSK A 50 ER20X100 M	50	1-13	28		100	74		M12
HSK A 50 ER20X120 M	50	1-13	28		120	94		M12
HSK A 63 ER16X100 M	63	0.5-10	22		100	74		M10
HSK A 63 ER16X120 M	63	0.5-10	22	40	120	94	78	M10
HSK A 63 ER16X160 M	63	0.5-10	22	40	160	134	85	M10
HSK A 63 ER20X100 M	63	1-13	28		100	74		M12
HSK A 63 ER20X120 M	63	1-13	28		120	94		M12
HSK A 63 ER20X160 M	63	1-13	28	45	160	134	85	M12
HSK A 100 ER16X100 M*	100	0.5-10	22		100	71		M10
HSK A 100 ER16X160 M*	100	0.5-10	22	40	160	131	85	M10
HSK A 100 ER20X100 M*	100	1-13	28		100	71		M12
HSK A 100 ER20X160 M*	100	1-13	28	45	160	131	85	M12

*Balance to G6.3 12,000RPM.

HSK - ER COLLET CHUCK - METRIC

Taper Size
HSK-A 40, 50, 63 & 100

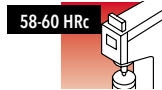
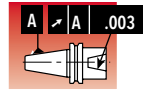

G2.5
20,000 RPM

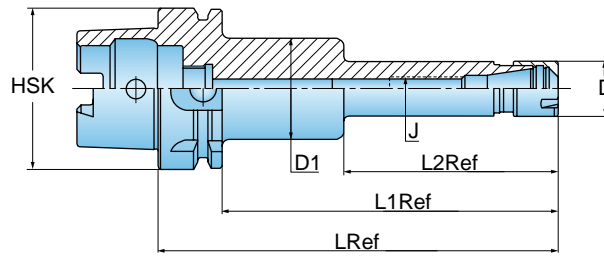

Designation	HSK-A	Range	D	D1	L	L1	L2	J
HSK A 40 ER16X60	40	0.5-10	28		60	40		M10
HSK A 40 ER16X80	40	0.5-10	28		80	60		M10
HSK A 40 ER16X100	40	0.5-10	28		100	80		M10
HSK A 50 ER16X100	50	0.5-10	28		100	74		M10
HSK A 50 ER16X120	50	0.5-10	28		120	94		M10
HSK A 50 ER20X100	50	1-13	34		100	74		M12
HSK A 50 ER20X120	50	1-13	34		120	94		M12
HSK A 63 ER16X100	63	0.5-10	28		100	74		M10
HSK A 63 ER16X120	63	0.5-10	28		120	94		M10
HSK A 63 ER16X160	63	0.5-10	28	40	160	134	85.6	M10
HSK A 63 ER20X100	63	1-13	34		100	74		M12
HSK A 63 ER20X120	63	1-13	34		120	94		M12
HSK A 63 ER20X160	63	1-13	34	45	160	134	85.0	M12
HSK A 100 ER16X100*	100	0.5-10	28		100	71		M10
HSK A 100 ER16X160*	100	0.5-10	28	40	160	131	85.0	M10
HSK A 100 ER20X100*	100	1-13	34		100	71		M12
HSK A 100 ER20X160*	100	1-13	34	45	160	131	85.0	M12

*Balance to G6.3 12,000 RPM.

HSK - ER COLLET CHUCK - METRIC

Taper Size
HSK-A 40, 50, 63 & 100

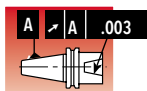

G2.5
20,000 RPM

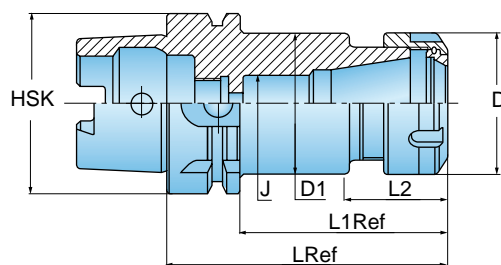

Designation	HSK-A	Range	D	D1	L	L1	L2	J
HSK A 40 ER25X60	40	1-16	42	32.4	40	60	28	-
HSK A 40 ER25X80	40	1-16	42	32.4	80	60	28	M18x1.5
HSK A 40 ER25X100	40	1-16	42	32.4	100	80	28	M16
HSK A 40 ER32X100	40	2-20	50	40.4	100	80	31	M22x1.5
HSK A 50 ER25X80	50	1-16	42	32.4	80	54	28	M16
HSK A 50 ER25X100	50	1-16	42	41.8	100	74	28.5	M16
HSK A 50 ER32X100	50	2-20	50	40.4	100	74	31	M22x1.5
HSK A 50 ER32X120	50	2-20	50	41.8	120	94	35	M22x1.5
HSK A 63 ER25X80	63	1-16	42	-	80	54	-	M16
HSK A 63 ER25X100	63	1-16	42	-	100	74	-	M16
HSK A 63 ER25X120	63	1-16	42	-	120	94	-	M16
HSK A 63 ER25X160	63	1-16	42	-	160	134	-	M16
HSK A 63 ER32X80	63	2-20	50	40.4	80	54	31	M22x1.5
HSK A 63 ER32X100	63	2-20	50	-	100	74	-	M22x1.5
HSK A 63 ER32X120	63	2-20	50	-	120	94	-	M22x1.5
HSK A 63 ER32X140	63	2-20	50	-	140	114	-	M22x1.5
HSK A 63 ER32X160	63	2-20	50	-	160	134	-	M22x1.5
HSK A 63 ER40X80	63	3-26	63	50.4	80	54	34	-
HSK A 63 ER40X100	63	3-26	63	50.4	100	74	34	M28x1.5
HSK A 63 ER40X120	63	3-26	63	50.4	120	94	34	M28x1.5
HSK A 100 ER25X100*	100	1-16	42	-	100	71	-	M16
HSK A 100 ER25X120*	100	1-16	42	-	120	91	-	M16
HSK A 100 ER25X160*	100	1-16	42	-	160	134	-	M16
HSK A 100 ER32X100*	100	2-20	50	-	100	71	-	M22x1.5
HSK A 100 ER32X120*	100	2-20	50	-	120	91	-	M22x1.5
HSK A 100 ER32X160*	100	2-20	50	-	160	131	-	M22x1.5
HSK A 100 ER40X100*	100	3-26	63	-	100	71	-	M28x1.5
HSK A 100 ER40X120*	100	3-26	63	-	120	91	-	M28x1.5
HSK A 100 ER40X160*	100	3-26	63	-	160	131	-	M28x1.5
HSK A 100 ER50X100*	100	10-34	78	-	100	71	-	-

*Balance to G2.5 12,000 RPM.

HSK - ER COLLET CHUCK - METRIC

Taper Size
HSK-FM 63

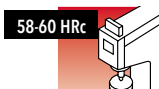
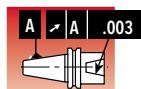

G2.5
30,000 RPM

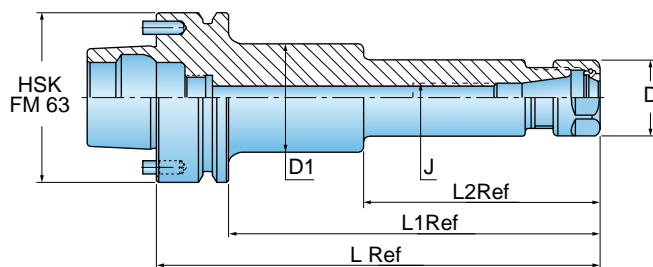

Used for MAKINO's machine models MAG3, MAG4 and V77. These tools are based on the HSK63F type with two drive pins which improve torque transmission.

Designation	HSK FM	Range	L	L1	L2	D	D1	J
HSK FM 63 ER16x80	63	0.5-10	80	54	-	28	-	M10
HSK FM 63 ER16x100	63	0.5-10	100	74	-	28	-	M10
HSK FM 63 ER16x120	63	0.5-10	120	94	-	28	-	M10
HSK FM 63 ER16x160	63	0.5-10	160	134	85.6	28	40	M10

*The driving pins can be removed, turning the toolholder into a standard HSK "F63" type.



HSK - ER COLLET CHUCK - METRIC

Taper Size
HSK-FM 63

G2.5
30,000 RPM

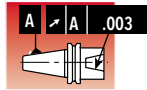
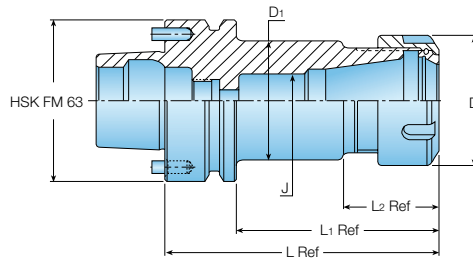

Used for MAKINO's machine models MAG3, MAG4 and V77. These tools are based on the HSK63F type with two drive pins which improve torque transmission.

Designation	HSK FM	Range	L	L1	L2	D	D1	J
HSK FM 63ER32x80	63	2-20	80	54	-	50	-	-
HSK FM 63ER32x100	63	2-20	100	74	-	50	-	M22x1.5
HSK FM 63ER40x80	63	3-26	80	54	32	63	50	-
HSK FM 63ER40x100	63	3-26	100	74	32	63	50	M28x1.5

* The driving pins can be removed, turning the toolholder into a standard HSK "F63" type.

HSK - END MILL HOLDER

Taper Size
HSK-A 50, 63 and 100

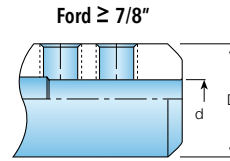
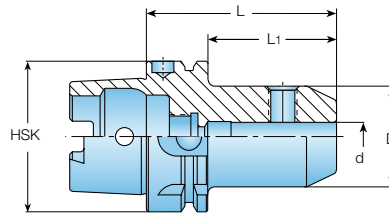
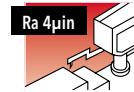
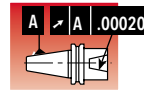

Designation	HSK-A	d	L	D	L1
HSK A 50 EM3/16 X2.562	50	.188	2.562	.866	1.538
HSK A 50 EM1/4 X2.562	50	.250	2.562	1.000	1.538
HSK A 50 EM3/8 X2.562	50	.375	2.562	1.378	1.538
HSK A 50 EM1/2 X3.125	50	.500	3.125	1.614	2.101
HSK A 50 EM5/8 X3.125	50	.625	3.125	1.752	2.101
HSK A 50 EM3/4 X3.125	50	.750	3.125	1.937	2.101
HSK A 50 EM7/8 X4.000	50	.875	4.000	2.205	2.976
HSK A 50 EM1 X4.250	50	1.000	4.250	2.563	3.226
HSK A 63 EM3/16 X2.562	63	.188	2.562	.866	1.538
HSK A 63 EM1/4 X2.562	63	.250	2.562	1.000	1.538
HSK A 63 EM3/8 X2.562	63	.375	2.562	1.378	1.538
HSK A 63 EM1/2 X3.125	63	.500	3.125	1.614	2.101
HSK A 63 EM5/8 X3.125	63	.625	3.125	1.752	2.101
HSK A 63 EM3/4 X3.150	63	.750	3.150	1.937	2.101
HSK A 63 EM7/8 X4.000	63	.875	4.000	2.047	2.976
HSK A 63 EM1 X4.250	63	1.000	4.250	2.563	3.226
HSK A 63 EM1-1/4X4.250	63	1.250	4.250	2.813	3.226
HSK A100 EM3/16 X3.125	100	.188	3.125	.866	1.983
HSK A100 EM1/4 X3.125	100	.250	3.125	1.000	1.983
HSK A100 EM3/8 X3.125	100	.375	3.125	1.378	1.983
HSK A100 EM1/2 X3.125	100	.500	3.125	1.614	1.983
HSK A100 EM5/8 X4.000	100	.625	4.000	1.752	2.858
HSK A100 EM3/4 X4.000	100	.750	4.000	1.937	2.858
HSK A100 EM7/8 X4.000	100	.875	4.000	2.047	2.858
HSK A100 EM1 X4.000	100	1.000	4.000	2.563	2.858
HSK A100 EM1-1/4X4.000	100	1.250	4.000	2.813	2.858
HSK A100 EM1-1/2X4.000	100	1.500	4.000	3.000	2.858

HSK - THERMAL SHRINK HOLDER

Taper Size
HSK-A 63 and 100

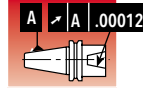

50-52 HRC



Ra 4µin



G2.5
25,000 RPM

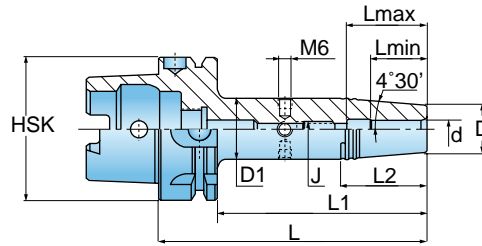

Designation	d	D	D1	L	L1	L2	Lmin	Lmax	J	Hex Key**
HSK A 63 SRKIN 1/4X3.150	.250	.827	1.060	3.150	2.126	1.500	.984	1.420	M5	2.5
HSK A 63 SRKIN5/16X3.150	.312	.827	1.060	3.150	2.216	1.500	.984	1.420	M6	3.0
HSK A 63 SRKIN 3/8X3.346	.375	.940	1.260	3.346	2.320	2.000	1.220	1.650	M8	4.0
HSK A 63 SRKIN7/16X3.543	.437	.940	1.260	3.543	2.519	2.000	1.417	1.850	M10	5.0
HSK A 63 SRKIN 1/2X3.543	.500	.940	1.260	3.543	2.519	2.000	1.417	1.850	M10	5.0
HSK A 63 SRKIN 5/8X3.740	.625	1.060	1.340	3.740	2.716	1.750	1.535	1.970	M12	6.0
HSK A 63 SRKIN 3/4X3.937	.750	1.300	1.650	3.937	2.913	2.250	1.614	2.050	M16	8.0
HSK A 63 SRKIN 7/8X3.937	.875	1.730	2.074	3.937	2.913	2.170	1.614	2.050	M16	8.0
HSK A 63 SRKIN1 X4.528	1.000	1.730	2.074	4.528	3.504	2.170	1.850	2.280	M16	8.0
HSK A 63 SRKIN1-1/4X4.72	1.250	1.730	2.074	4.725	3.700	2.170	1.850	2.280	M16	8.0
HSK A 100 SRKIN 1/4X3.500*	.250	.827	1.060	3.500	2.358	1.500	.984	1.420	M5	2.5
HSK A 100 SRKIN 1/4X4.750*	.250	.827	1.060	4.750	3.608	1.500	.984	1.420	M5	2.5
HSK A 100 SRKIN 1/4X6.250*	.250	.827	1.060	6.250	5.108	1.500	.984	1.420	M5	2.5
HSK A 100 SRKIN5/16X3.500*	.313	.827	1.060	3.500	2.358	1.500	.984	1.420	M6	3.0
HSK A 100 SRKIN5/16X4.750*	.313	.827	1.060	4.750	3.608	1.500	.984	1.420	M6	3.0
HSK A 100 SRKIN5/16X6.250*	.313	.827	1.060	6.250	5.108	1.500	.984	1.420	M6	3.0
HSK A 100 SRKIN 3/8X3.625*	.375	.940	1.260	3.625	2.483	2.000	1.220	1.650	M8	4.0
HSK A 100 SRKIN 3/8X4.750*	.375	.940	1.260	4.750	3.608	2.000	1.220	1.650	M8	4.0
HSK A 100 SRKIN 3/8X6.250*	.375	.940	1.260	6.250	5.108	2.000	1.220	1.650	M8	4.0
HSK A 100 SRKIN7/16X3.750*	.438	.940	1.260	3.750	2.608	2.000	1.417	1.850	M10	5.0
HSK A 100 SRKIN7/16X4.750*	.438	.940	1.260	4.750	3.608	2.000	1.417	1.850	M10	5.0
HSK A 100 SRKIN7/16X6.250*	.438	.940	1.260	6.250	5.108	2.000	1.417	1.850	M10	5.0
HSK A 100 SRKIN 1/2X3.750*	.500	.940	1.260	3.750	2.608	2.000	1.417	1.850	M10	5.0
HSK A 100 SRKIN 1/2X5.000*	.500	.940	1.260	5.000	3.858	2.000	1.417	1.850	M10	5.0
HSK A 100 SRKIN 1/2X6.250*	.500	.940	1.260	6.250	5.108	2.000	1.417	1.850	M10	5.0
HSK A 100 SRKIN 5/8X4.000*	.625	1.060	1.340	4.000	2.858	1.750	1.535	1.970	M12	6.0
HSK A 100 SRKIN 5/8X5.000*	.625	1.060	1.340	5.000	3.858	1.750	1.535	1.970	M12	6.0
HSK A 100 SRKIN 5/8X6.250*	.625	1.060	1.340	6.250	5.108	1.750	1.535	1.970	M12	6.0
HSK A 100 SRKIN 3/4X4.125*	.750	1.300	1.650	4.125	2.983	2.250	1.614	2.050	M12	6.0
HSK A 100 SRKIN 3/4X6.250*	.750	1.300	1.650	6.250	5.108	2.250	1.614	2.050	M16	8.0
HSK A 100 SRKIN 7/8X4.125*	.875	1.730	2.090	4.125	2.983	2.250	1.614	2.050	M12	6.0
HSK A 100 SRKIN 7/8X6.250*	.875	1.730	2.090	6.250	5.108	2.250	1.614	2.050	M16	8.0
HSK A 100 SRKIN 1X4.500*	1.000	1.730	2.090	4.500	3.358	2.250	1.850	2.280	M12	6.0
HSK A 100 SRKIN1-1/4X4.75*	1.250	1.730	2.090	4.750	3.608	2.250	1.850	2.280	M12	6.0

* Balanced to G2.5 20,000 RPM.

** Metric

HSK - THERMAL SHRINK HOLDER - METRIC

Taper Size
HSK-A 63

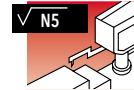
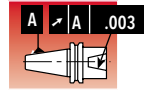

G2.5
25,000 RPM

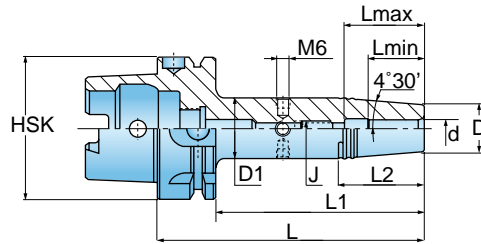

Designation	d	D	D1	L	L1	L2	Lmin	Lmax	J	Hex Key
HSK A 63 SRKIN 6X 80	6	21	27	80	54	38	25	36	M5	2.5
HSK A 63 SRKIN 6X120	6	21	27	120	94	38	25	36	M5	2.5
HSK A 63 SRKIN 6X160	6	21	27	160	134	38	25	36	M5	2.5
HSK A 63 SRKIN 8X 80	8	21	27	80	54	38	25	36	M6	3.0
HSK A 63 SRKIN 8X120	8	21	27	120	94	38	25	36	M6	3.0
HSK A 63 SRKIN 8X160	8	21	27	160	134	38	25	36	M6	3.0
HSK A 63 SRKIN 10X 85	10	24	32	85	59	51	31	42	M8	4.0
HSK A 63 SRKIN 10X120	10	24	32	120	94	51	31	42	M8	4.0
HSK A 63 SRKIN 10X160	10	24	32	160	134	51	31	42	M8	4.0
HSK A 63 SRKIN 12X 90	12	24	32	90	64	51	36	42	M8	4.0
HSK A 63 SRKIN 12X120	12	24	32	120	94	51	36	47	M10	5.0
HSK A 63 SRKIN 12X160	12	24	32	160	134	51	36	47	M10	5.0
HSK A 63 SRKIN 14X 90	14	27	34	90	64	45	36	47	M10	5.0
HSK A 63 SRKIN 14X120	14	27	34	120	94	45	36	47	M10	5.0
HSK A 63 SRKIN 14X160	14	27	34	160	134	45	36	47	M10	5.0
HSK A 63 SRKIN 16X 95	16	27	34	95	69	44	39	50	M12	6.0
HSK A 63 SRKIN 16X120	16	27	34	120	94	44	39	50	M12	6.0
HSK A 63 SRKIN 16X160	16	27	34	160	134	44	39	50	M12	6.0
HSK A 63 SRKIN 18X 95	18	33	42	95	69	57	39	50	M12	6.0
HSK A 63 SRKIN 18X120	18	33	42	120	94	57	39	50	M12	6.0
HSK A 63 SRKIN 18X160	18	33	42	160	134	57	39	50	M12	6.0
HSK A 63 SRKIN 20X100	20	33	42	100	74	57	41	52	M16	8.0
HSK A 63 SRKIN 20X120	20	33	42	120	94	57	41	52	M16	8.0
HSK A 63 SRKIN 20X160	20	33	42	160	134	57	41	52	M16	8.0
HSK A 63 SRKIN 25X115	25	44	53	115	89	55	47	58	M16	8.0
HSK A 63 SRKIN 32X120	32	44	53	120	94	55	4758	M16	8.0	

HSK - THERMAL SHRINK HOLDER - METRIC

Taper Size
HSK-A 100

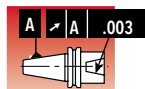

G2.5
20,000 RPM

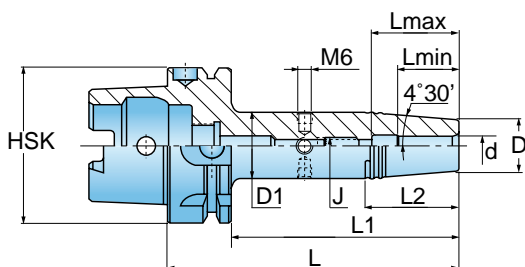

Designation	d	D	D1	L	L1	L2	Lmin	Lmax	J	Hex Key
HSK A 100 SRKIN 6X 85	6	21	27	85	56	38	25	36	M5	2.5
HSK A 100 SRKIN 6X120	6	21	27	120	91	38	25	36	M5	2.5
HSK A 100 SRKIN 6X160	6	21	27	160	131	38	25	36	M6	3.0
HSK A 100 SRKIN 8X 85	8	21	27	85	56	38	25	36	M6	3.0
HSK A 100 SRKIN 8X120	8	21	27	120	91	38	25	36	M6	3.0
HSK A 100 SRKIN 8X160	8	21	27	160	131	38	25	36	M6	3.0
HSK A 100 SRKIN 10X 90	10	24	32	90	61	51	31	42	M8	4.0
HSK A 100 SRKIN 10X120	10	24	32	120	91	51	31	42	M8	4.0
HSK A 100 SRKIN 10X160	10	24	32	160	131	51	31	42	M8	4.0
HSK A 100 SRKIN 12X 95	12	24	32	95	66	51	36	47	M10	5.0
HSK A 100 SRKIN 12X120	12	24	32	120	91	51	36	47	M10	5.0
HSK A 100 SRKIN 12X160	12	24	32	160	131	51	36	47	M10	5.0
HSK A 100 SRKIN 14X 95	14	27	34	95	66	45	36	47	M10	5.0
HSK A 100 SRKIN 14X120	14	27	34	120	91	45	36	47	M10	5.0
HSK A 100 SRKIN 14X160	14	27	34	160	131	45	36	47	M10	5.0
HSK A 100 SRKIN 16X100	16	27	34	100	71	45	39	50	M12	6.0
HSK A 100 SRKIN 16X120	16	27	34	120	91	45	39	50	M12	6.0
HSK A 100 SRKIN 16X160	16	27	34	160	131	45	39	50	M12	6.0
HSK A 100 SRKIN 18X100	18	33	42	100	71	57	39	50	M12	6.0
HSK A 100 SRKIN 18X160	18	33	42	160	131	57	39	50	M12	6.0
HSK A 100 SRKIN 20X105	20	33	42	105	76	57	41	52	M16	8.0
HSK A 100 SRKIN 20X160	20	33	42	160	131	57	41	52	M16	8.0
HSK A 100 SRKIN 25X115	25	44	53	115	86	57	47	58	M16	8.0
HSK A 100 SRKIN 32X120	32	44	53	120	91	57	47	58	M16	8.0

Use only inductive heating device for SRKIN holders.

HSK - THERMAL SHRINK HOLDER FOR MAKINO MAG3, MAG4 AND V77 MACHINE MODELS

Taper Size
HSK FM-63

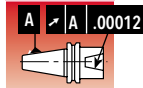

G2.5
30,000 RPM

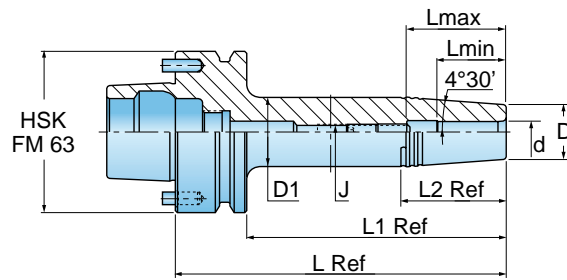

Designation	d	D1	D	L	L1	L2	Lmin	Lmax	J	Hex*
HSK FM 63 SRKIN 1/4x3.13	.250	1.063	.827	3.130	2.106	1.500	.984	1.417	M5	2.5
HSK FM 63 SRKIN 5/16x3.13	.313	1.063	.827	3.130	2.106	1.500	.984	1.417	M6	3.0
HSK FM 63 SRKIN 3/8x3.50	.375	1.260	.945	3.500	2.476	2.000	1.220	1.654	M8	4.0
HSK FM 63 SRKIN 1/2x3.50	.500	1.260	.945	3.500	2.476	2.000	1.417	1.850	M8	4.0
HSK FM 63 SRKIN 5/8x3.50	.625	1.339	1.063	3.500	2.476	1.752	1.535	1.969	M8	4.0
HSK FM 63 SRKIN 3/4x3.00	.750	1.610	1.299	3.000	2.976	-	1.614	2.047	-	-
HSK FM 63 SRKIN 3/4x3.75	.750	1.654	1.299	3.750	2.726	2.250	1.614	2.047	M12	6.0
HSK FM 63 SRKIN 1x3.00	1.000	2.043	1.732	3.000	2.976	-	1.850	2.126	-	-
HSK FM 63 SRKIN 1x4.00	1.000	2.075	1.732	4.000	2.976	2.252	1.850	2.283	M16	8.0

* Metric

** The driving pins can be removed, turning the toolholder into a standard HSK F type.

Used for MAKINO's machine models MAG3, MAG4 and V77

These tools are based on the HSK 63 F type with two drive pins which improve torque transmission.

HSK - THERMAL SHRINK HOLDER FOR MAKINO MAG3, MAG4 AND V77 MACHINE MODELS - METRIC

Taper Size
HSK-FM 63

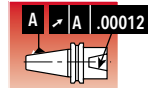

50-52 HRC

Ra 4µm

G2.5
30,000 RPM

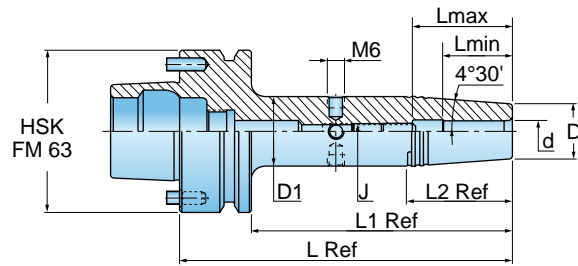

Designation	d	D	D1	L	L1	L2	Lmin	Lmax	J	Hex
HSK FM 63 SRKIN 6x80	6	21	27.0	80	54	38.0	25	36	M5	2.5
HSK FM 63 SRKIN 8x80	8	21	27.0	80	54	38.0	25	36	M6	3.0
HSK FM 63 SRKIN 10x85	10	24	32.0	85	59	50.5	31	42	M8	4.0
HSK FM 63 SRKIN 12x90	12	24	32.0	90	64	50.5	36	47	M10	5.0
HSK FM 63 SRKIN 14x90	14	27	34.0	90	64	44.5	36	47	M10	5.0
HSK FM 63 SRKIN 16x95	16	27	34.0	95	69	44.5	39	50	M12	6.0
HSK FM 63 SRKIN 18x95	18	33	42.0	95	69	57.0	39	50	M12	6.0
HSK FM 63 SRKIN 20x100	20	33	42.0	100	74	57.0	41	52	M16	8.0
HSK FM 63 SRKIN 25x115	25	44	52.7	115	89	55.0	47	58	M16	8.0
HSK FM 63 SRKIN 32x120	32	44	52.7	120	94	55.0	47	58	M16	8.0

** The driving pins can be removed, turning the toolholder into a standard HSK F 63 type.

Used for MAKINO's machine models MAG3, MAG4 and V77

These tools are based on the HSK 63 F type with two drive pins which improve torque transmission.

HSK - THERMAL SHRINK HOLDER

Taper Size
HSK-E 32, 40, 50 & 63

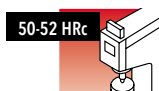
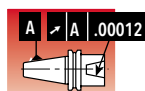

G2.5
40,000 RPM

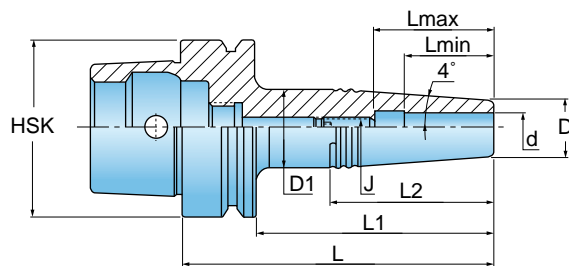

Designation	d	D1	D	L	L1	L2	Lmin	Lmax	J	Hex key***
HSK E 32 SRK1/8X2.000	.125	.591	.394	2.787	2.000	1.407	.394	.787	M4	2.0
HSK E 32 SRK3/16X2.000	.187	.591	.394	2.787	2.000	1.407	.591	.984	M4	2.0
HSK E 32 SRK1/4X2.000	.250	.630	.433	2.787	2.000	1.406	.709	1.102	M4	2.0
HSK E 32 SRK5/16X2.000	.312	.787	.551	2.787	2.000	1.406	.984	1.378	M4	2.0
HSK E 32 SRK3/8X2.000	.375	.866	.630	2.787	2.000	1.677	1.181	1.575	M4	2.0
HSK E 32 SRK1/2X2.000	.500	.984	.787	2.787	2.000	1.392	1.260	1.575	M4	2.0
HSK E 40 SRK1/8 X1.750	.125	.390	.590	2.537	1.750	1.400	.394	.630	M5	2.5
HSK E 40 SRK1/8 X3.000	.125	.390	.748	3.787	3.000	2.526	.394	.630	M5	2.5
HSK E 40 SRK3/16X1.750	.187	.390	.590	2.537	1.750	1.400	.590	.984	M4	2.0
HSK E 40 SRK3/16X3.000	.187	.390	.748	3.787	3.000	2.526	.590	.984	M4	2.0
HSK E 40 SRK1/4 X1.750	.250	.430	.630	2.537	1.750	1.400	.709	1.102	M5	2.5
HSK E 40 SRK1/4 X3.000	.250	.430	.787	3.787	3.000	2.524	.709	1.102	M5	2.5
HSK E 40 SRK5/16X1.750	.312	.787	.550	2.537	1.750	1.673	.984	1.378	M5	2.5
HSK E 40 SRK5/16X3.000	.312	.550	.905	3.787	3.000	2.518	.984	1.378	M6	3.0
HSK E 40 SRK3/8 X1.750	.375	.630	.866	2.537	1.750	1.670	1.181	1.575	M5	2.5
HSK E 40 SRK3/8 X3.000	.375	.630	.965	3.787	3.000	2.373	1.181	1.575	M8	4.0
HSK E 40 SRK7/16X1.750	.437	.790	1.024	2.537	1.750	1.665	1.220	1.614	M5	2.5
HSK E 40 SRK7/16X3.000	.437	.790	1.102	3.787	3.000	2.229	1.220	1.614	M10	5.0
HSK E 40 SRK1/2 X1.750	.500	.790	1.024	2.537	1.750	1.665	1.260	1.654	M5	2.5
HSK E 40 SRK1/2 X3.000	.500	.790	1.102	3.787	3.000	2.229	1.260	1.654	M10	5.0
HSK E 50 SRK1/8 X1.750*	.125	.390	.590	2.774	1.750	1.400	.394	.630	M5	2.5
HSK E 50 SRK1/8 X3.000*	.125	.390	.748	4.024	3.000	2.526	.394	.630	M5	2.5
HSK E 50 SRK3/16X1.750*	.187	.390	.590	2.774	1.750	1.400	.590	.826	M6	3.0
HSK E 50 SRK3/16X3.000*	.187	.390	.748	4.024	3.000	2.526	.590	.826	M6	3.0
HSK E 50 SRK1/4 X1.750*	.250	.430	.630	2.774	1.750	1.400	.709	1.102	M5	2.5
HSK E 50 SRK1/4 X3.000*	.250	.430	.787	4.024	3.000	2.524	.709	1.102	M5	2.5
HSK E 50 SRK5/16X1.750*	.312	.550	.787	2.774	1.750	1.673	.984	1.378	M6	3.0
HSK E 50 SRK5/16X3.000*	.312	.550	.905	4.024	3.000	2.518	.984	1.378	M6	3.0
HSK E 50 SRK3/8 X1.750*	.375	.630	.866	2.774	1.750	1.670	1.181	1.575	M6	3.0
HSK E 50 SRK3/8 X3.000*	.375	.630	.965	4.024	3.000	2.373	1.181	1.575	M8	4.0
HSK E 50 SRK7/16X1.750*	.437	.790	1.024	2.774	1.750	1.665	1.220	1.614	M6	3.0
HSK E 50 SRK7/16X3.000*	.437	.790	1.102	4.024	3.000	2.229	1.220	1.614	M10	5.0
HSK E 50 SRK1/2 X1.750*	.500	.790	1.024	2.774	1.750	1.665	1.260	1.654	M6	3.0
HSK E 50 SRK1/2 X3.000*	.500	.790	1.102	4.024	3.000	2.229	1.260	1.654	M10	5.0
HSK E 63 SRK1/8 X1.750**	.125	.390	.590	2.774	1.750	1.400	.394	.630	M6	3
HSK E 63 SRK1/8 X3.000**	.125	.390	.748	4.024	3.000	2.526	.394	.630	M6	3
HSK E 63 SRK3/16X1.750**	.187	.390	.590	2.774	1.750	1.400	.590	.826	M6	3
HSK E 63 SRK3/16X3.000**	.187	.390	.748	4.024	3.000	2.526	.590	.826	M6	3
HSK E 63 SRK1/4 X1.750**	.250	.430	.630	2.774	1.750	1.400	.709	.945	M8	4
HSK E 63 SRK1/4 X3.000**	.250	.430	.787	4.024	3.000	2.524	.709	.945	M8	4
HSK E 63 SRK5/16X1.750**	.312	.550	.787	2.774	1.750	1.673	.984	1.378	M6	3
HSK E 63 SRK5/16X3.000**	.312	.550	.905	4.024	3.000	2.518	.984	1.378	M6	3
HSK E 63 SRK3/8 X1.750**	.375	.630	.866	2.774	1.750	1.670	1.181	1.575	M8	4
HSK E 63 SRK3/8 X3.000**	.375	.630	1.000	4.024	3.000	2.373	1.181	1.575	M8	4
HSK E 63 SRK7/16X1.750**	.437	.790	1.024	2.774	1.750	1.665	1.220	1.614	M8	4
HSK E 63 SRK7/16X3.000**	.437	.790	1.102	4.024	3.000	2.229	1.220	1.614	M10	5
HSK E 63 SRK1/2 X1.750**	.500	.790	1.024	2.774	1.750	1.665	1.260	1.654	M8	4
HSK E 63 SRK1/2 X3.000**	.500	.790	1.102	4.024	3.000	2.229	1.260	1.654	M10	5

* Balanced to G2.5 35,000 RPM

** Balanced to G2.5 30,000 RPM

*** Metric

HSK - THERMAL SHRINK HOLDER - METRIC

Taper Size
HSK-E 32, 40, 50 & 63

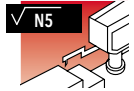
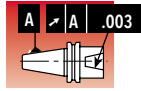

G2.5
40,000 RPM

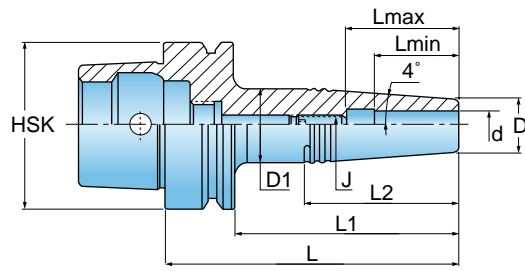

Designation	d	D1	D	L	L1	L2	Lmin	Lmax	J	Hex Key
HSK E 32 SRK 3X 45	3	13.0	10	65	45	30	10	16	M4	2.0
HSK E 32 SRK 4X 45	4	15.0	10	65	45	35	12	18	M4	2.0
HSK E 32 SRK 5X 45	5	15.0	10	65	45	35	15	25	M4	2.0
HSK E 32 SRK 6X 45	6	16.0	11	65	45	35	18	28	M4	2.0
HSK E 32 SRK 8X 45	8	20.0	14	65	45	42	25	35	M4	2.0
HSK E 32 SRK 10X 45	12	22.0	16	65	45	42	30	40	M4	2.0
HSK E 32 SRK 12X 45	12	25.0	20	65	45	35.6	32	40	M4	2.0
HSK E 40 SRK 3X 45	3	13.0	10	65	45	30	10	16	M5	2.5
HSK E 40 SRK 3X 80	3	19.0	10	100	80	64	10	16	M5	2.5
HSK E 40 SRK 4X 45	4	15.0	10	65	45	35	12	18	M5	2.5
HSK E 40 SRK 4X 80	4	19.0	10	100	80	64	12	18	M5	2.5
HSK E 40 SRK 5X 45	5	15.0	10	65	45	35	15	25	M4	2.0
HSK E 40 SRK 5X 80	5	19.0	10	100	80	64	15	25	M4	2.0
HSK E 40 SRK 6X 45	6	16.0	11	65	45	35	18	28	M5	2.5
HSK E 40 SRK 6X 80	6	20.0	11	100	80	64	18	28	M5	2.5
HSK E 40 SRK 8X 45	8	20.0	14	65	45	42	25	35	M5	2.5
HSK E 40 SRK 8X 80	8	23.0	14	100	80	64	25	35	M6	3.0
HSK E 40 SRK 10X 45	10	22.0	16	65	45	42	30	40	M5	2.5
HSK E 40 SRK 10X 80	10	24.5	16	100	80	60	30	40	M8	4.0
HSK E 40 SRK 12X 45	12	26.0	20	65	45	42	32	42	M5	2.5
HSK E 40 SRK 12X 80	12	28.0	20	100	80	56	32	42	M10	5.0
HSK E 50 SRK 3X 45*	3	15.0	10	71	45	36	10	16	M5	2.5
HSK E 50 SRK 3X 80*	3	19.0	10	106	80	64	10	16	M5	2.5
HSK E 50 SRK 4X 45*	4	15.0	10	71	45	36	12	18	M5	2.5
HSK E 50 SRK 4X 80*	4	19.0	10	106	80	64	12	18	M5	2.5
HSK E 50 SRK 5X 45*	5	15.0	10	71	45	36	15	21	M6	3.0
HSK E 50 SRK 5X 80*	5	19.0	10	106	80	64	15	21	M6	3.0
HSK E 50 SRK 6X 45*	6	16.0	11	71	45	36	18	28	M5	2.5
HSK E 50 SRK 6X 80*	6	20.0	11	106	80	64	18	28	M5	2.5
HSK E 50 SRK 8X 45*	8	20.0	14	71	45	43	25	35	M6	3.0
HSK E 50 SRK 8X 80*	8	23.0	14	106	80	64	25	35	M6	3.0
HSK E 50 SRK 10X 45*	10	22.0	16	71	45	42	30	37	M6	3.0
HSK E 50 SRK 10X 80*	10	24.5	16	106	80	60	30	40	M8	4.0
HSK E 50 SRK 12X 45*	12	26.0	20	71	45	42	32	39	M6	3.0
HSK E 50 SRK 12X 80*	12	28.0	20	106	80	57	32	42	M10	5.0
HSK E 63 SRK 3X 45**	3	15.0	10	71	45	36	10	16	M6	3
HSK E 63 SRK 3X 80**	3	19.0	10	106	80	64	10	16	M6	3
HSK E 63 SRK 4X 45**	4	15.0	10	71	45	36	12	18	M6	3
HSK E 63 SRK 4X 80**	4	19.0	10	106	80	64	12	18	M6	3
HSK E 63 SRK 5X 45**	5	15.0	10	71	45	36	15	21	M6	3
HSK E 63 SRK 5X 80**	5	19.0	10	106	80	64	15	21	M6	3
HSK E 63 SRK 6X 45**	6	16.0	11	71	45	36	18	24	M8	4
HSK E 63 SRK 6X 80**	6	20.0	11	106	80	64	18	24	M8	4
HSK E 63 SRK 8X 45**	8	20.0	14	71	45	43	25	35	M6	3
HSK E 63 SRK 8X 80**	8	23.0	14	106	80	64	25	35	M6	3
HSK E 63 SRK 10X 45**	10	22.0	16	71	45	42	30	40	M8	4
HSK E 63 SRK 10X 80**	10	24.5	16	106	80	60	30	40	M8	4
HSK E 63 SRK 12X 45**	12	26.0	20	71	45	42	32	42	M8	4
HSK E 63 SRK 12X 80**	12	28.0	20	106	80	57	32	42	M10	5
HSK E 63 SRK 12X 90**	12	28.0	20	116	90	57	32	43	M8	4

* Balanced to G2.5 35,000 RPM

** Balanced to G2.5 30,000 RPM

HSK - THERMAL SHRINK HOLDER

Taper Size
HSK-A 63

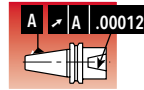

G2.5
25,000 RPM

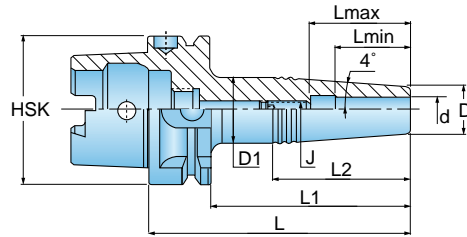

Designation	d	D	D1	L	L1	L2	Lmin	Lmax	J	Hex Key*
HSK A 63 SRK1/8 X2.000	.125	.390	.699	3.024	2.000	-	.394	.630	M6	3
HSK A 63 SRK1/8 X3.250	.125	.390	.823	4.274	3.250	3.098	.394	.630	M6	3
HSK A 63 SRK3/16X2.000	.187	.390	.699	3.024	2.000	-	.590	.826	M6	3
HSK A 63 SRK3/16X3.250	.187	.390	.823	4.274	3.250	3.098	.590	.826	M6	3
HSK A 63 SRK1/4 X2.000	.250	.430	.699	3.024	2.000	-	.709	.945	M8	4
HSK A 63 SRK1/4 X3.250	.250	.430	.823	4.274	3.250	3.098	.709	.945	M8	4
HSK A 63 SRK5/16X2.000	.312	.550	.709	3.024	2.000	-	.984	1.417	M6	3
HSK A 63 SRK5/16X3.250	.312	.550	.866	4.274	3.250	3.098	.984	1.417	M6	3
HSK A 63 SRK3/8 X2.000	.375	.630	.787	3.024	2.000	1.693	1.181	1.614	M8	4
HSK A 63 SRK3/8 X3.250	.375	.630	.906	4.274	3.250	2.535	1.181	1.614	M8	4
HSK A 63 SRK7/16X2.000	.437	.790	.906	3.024	2.000	-	1.220	1.654	M8	4
HSK A 63 SRK7/16X3.250	.437	.790	1.024	4.274	3.250	2.815	1.220	1.654	M10	5
HSK A 63 SRK1/2 X2.000	.500	.790	1.063	3.024	2.000	-	1.260	1.693	M8	4
HSK A 63 SRK1/2 X3.250	.500	.790	1.181	4.274	3.250	2.815	1.260	1.693	M10	5

* Metric



HSK - THERMAL SHRINK HOLDER - METRIC

Taper Size
HSK-A 63

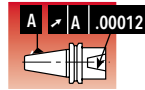

50-52 HRC



Ra 4µm



G2.5
25,000 RPM

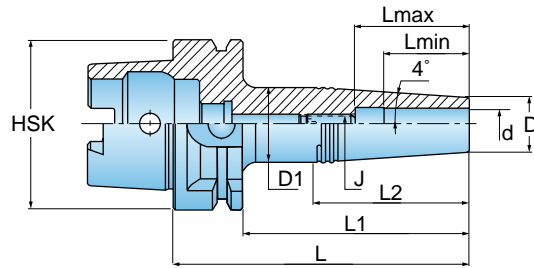

Designation	d	D1	D	L	L1	L2	Lmin	Lmax	J	Hex Key
HSK A 63 SRK 3X 50	3	17.0	10	76	50		10	16	M6	3
HSK A 63 SRK 3X 85	3	21.0	10	111	85	79	10	16	M6	3
HSK A 63 SRK 4X 50	4	17.0	10	76	50		12	18	M6	3
HSK A 63 SRK 4X 85	4	21.0	10	111	85	79	12	18	M6	3
HSK A 63 SRK 5X 50	5	17.0	10	76	50		15	21	M6	3
HSK A 63 SRK 5X 85	5	21.0	10	111	85	79	15	21	M6	3
HSK A 63 SRK 6X 50	6	18.0	11	76	50		18	24	M8	4
HSK A 63 SRK 6X 85	6	22.0	11	111	85	79	18	24	M8	4
HSK A 63 SRK 8X 50	8	20.0	14	76	50	43	25	36	M6	3
HSK A 63 SRK 8X 85	8	23.0	14	111	85	64	25	36	M6	3
HSK A 63 SRK 10X 50	10	23.0	16	76	50		30	41	M8	4
HSK A 63 SRK 10X 85	10	26.0	16	111	85	72	30	41	M8	4
HSK A 63 SRK 12X 50	12	27.0	20	76	50		32	43	M8	4
HSK A 63 SRK 12X 85	12	30.0	20	111	85	72	32	43	M8	4

HSK - SHELL MILL ADAPTER

Taper Size
HSK-E 32, 40, 50 & 63

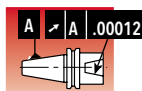

G2.5
15,000 RPM

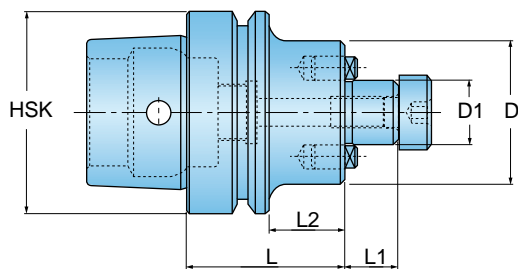

Designation	HSK-E	D1	L	L2	D	L1
HSK E 32 SEM3/4 X2.000	32	.750	2.000	1.213	1.771	.669
HSK E 40 SEM3/4 X2.000	40	.750	2.000	1.213	1.771	.669
HSK E 50 SEM3/4 X2.375	50	.750	2.375	1.351	1.771	.669
HSK E 63 SEM3/4 X2.375	63	.750	2.375	1.351	1.771	.669
HSK E 63 SEM 1 X2.375	63	1.000	2.375	1.351	2.079	.669

Face mill DIN 6357



HSK - SHELL MILL ADAPTER

Taper Size
HSK-A 50, 63 and 100

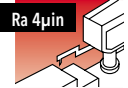
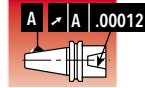

G2.5
15,000 RPM

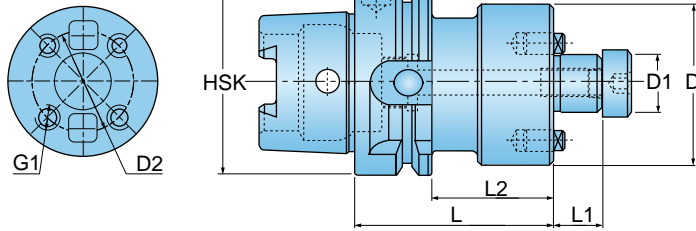

Designation	HSK-A	D1	L	L1	L2	D
HSK A50 SEM3/4 X2.375	50	.750	2.375	.669	1.351	1.770
HSK A50 SEM1 X2.500	50	1.000	2.500	.669	1.476	2.172
HSK A50 SEM1-1/4 X3.000	50	1.250	3.000	.669	1.976	2.516
HSK A63 SEM3/4 X2.375	63	.750	2.375	.669	1.351	1.770
HSK A63 SEM1 X1.750	63	1.000	1.750	.669	.726	2.086
HSK A63 SEM1-1/4 X2.375	63	1.250	2.375	.669	1.351	2.510
HSK A63 SEM1-1/2 X2.375	63	1.500	2.375	.938	1.351	3.070
HSK A63 SEM2 X2.375	63	2.000	2.375	.938	1.351	3.850
HSK A100 SEM3/4 X3.000*	100	.750	3.000	.669	1.858	1.770
HSK A100 SEM1 X2.375*	100	1.000	2.375	.669	1.233	2.165
HSK A100 SEM1-1/4 X1.875*	100	1.250	1.875	.669	.733	2.500
HSK A100 SEM1-1/2 X1.875*	100	1.500	1.875	.938	.733	3.881
HSK A100 SEM2 X2.375*	100	2.000	2.375	.938	1.233	3.881

* Balanced to G6.3 12,000 RPM

HSK - FACE MILL HOLDER

Taper Size
HSK-A 100

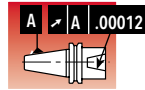

58-60 HRc

Ra 4µin



G2.5
15,000 RPM

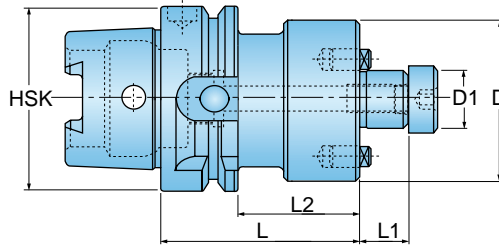
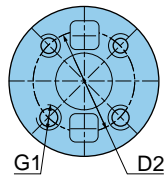

Designation	D1	L	L1	D	D2*	G1*
HSK A100 FM2-1/2x2.875	2.500	2.875	1.122	4.881	1.125	5/8-11

* Exists only in "FM" holders



HSK - SHELL MILL ADAPTER - METRIC

Taper Size
HSK-E 32, 40, 50 & 63

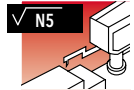
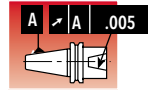

G2.5
15,000 RPM

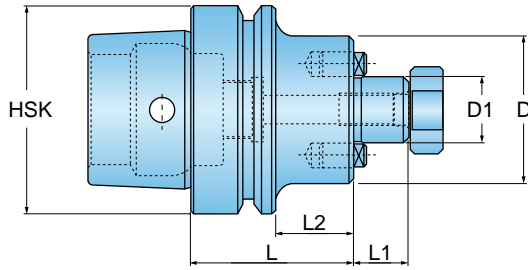

Designation	HSK-E	D1	D	L	L2	L1
HSK E 32 SEM 16x50	32	16	38	50	30	17
HSK E 32 SEM 22x50	32	22	47	50	30	19
HSK E 40 SEM 16x50	40	16	38	50	30	17
HSK E 40 SEM 22x50	40	22	47	50	30	19
HSK E 50 SEM 22X 60	50	22	47	60	34	19
HSK E 63 SEM 16X 50	63	16	38	50	24	17
HSK E 63 SEM 22X 50	63	22	47	50	24	19

HSK - SHELL MILL ADAPTER - METRIC

Taper Size
HSK-A 40, 50, 63 & 100

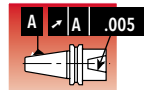

G2.5
15,000 RPM

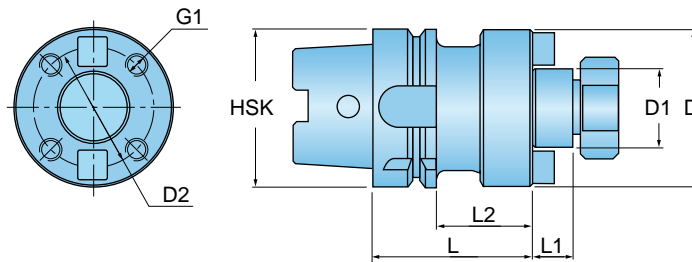

Designation	HSK-A	D1	L	D	L1	L2
HSK A 40 SEM 22	40	22	47	50	19	30
HSK A 40 SEM 27	40	27	58	55	21	35
HSK A 50 SEM 16X 50	50	16	50	38	17	24
HSK A 50 SEM 22X 60	50	22	60	47	19	34
HSK A 50 SEM 27X 60	50	27	60	58	21	34
HSK A 63 SEM 16X 50	63	16	50	38	17	24
HSK A 63 SEM 22X 50	63	22	50	47	19	24
HSK A 63 SEM 27X 60	63	27	60	58	21	34
HSK A 63 SEM 32X 60	63	32	60	66	24	34
HSK A 63 SEM 40X 60	63	40	60	82	27	34
HSK A 100 SEM 22X 50*	100	22	50	47	19	21
HSK A 100 SEM 27X 50*	100	27	50	58	21	21
HSK A 100 SEM 32X 50*	100	32	50	66	24	21
HSK A 100 SEM 40X 60*	100	40	60	82	27	31
HSK A 100 SEM 50X 70*	100	50	70	95	30	41

* Balanced to G6.3 12,000 RPM



HSK - FACE MILL HOLDER - METRIC

Taper Size
HSK-A 100

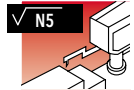
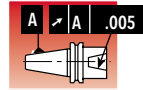

G2.5
15,000 RPM

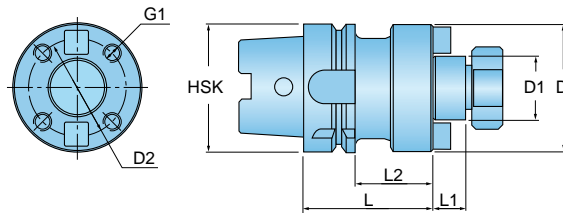

Designation	HSK-A	D1	L	D	L1	D2*	G1*
HSK A 100 FM 60X70	100	60	70	128	40	101.6	M16

* Available only "FM" holders

HSK - SHELL MILL ADAPTER FOR MAKINO MAG3, MAG4 AND V77 MACHINE MODELS

Taper Size
HSK-FM 63

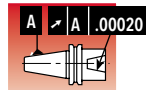

58-60 HRc

Ra 4µin



G2.5
30,000 RPM

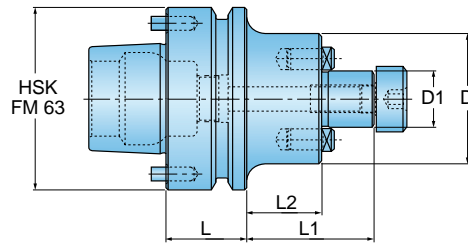

Used for MAKINO's machine models MAG3, MAG4 and V77. These tools are based on the HSK 63 F type with two drive pins which improve torque transmission.

Designation	D1	L	D	L1	L2
HSK FM 63 SEM 3/4x3.00	.750	3.000	1.772	.669	1.876
HSK FM 63 SEM 3/4x4.50	.750	4.500	1.772	.669	3.476
HSK FM 63 SEM 1x2.375	1.000	2.375	2.079	.669	1.351



HSK - SHELL MILL ADAPTER FOR MAKINO MAG3, MAG4 AND V77 MACHINE MODELS - METRIC

Taper Size
HSK-FM 63

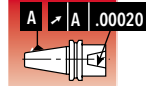

58-60 HRC



Ra 4µm



 **G2.5**
30,000 RPM

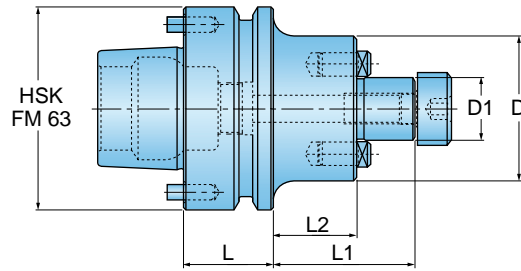

Used for MAKINO's machine models MAG3, MAG4 and V77. These tools are based on the HSK 63 F type with two drive pins which improve torque transmission.

Designation	D1	L	D	L1	L2
HSK FM 63 SEM 22x60	22	60	47	19	34
HSK FM 63 SEM 27x60	27	60	58	21	34
HSK FM 63 SEM 32x60	32	60	66	24	34

* The driving pins can be removed, turning the toolholder into a standard HSK F type.

HSK - MORSE TAPER ADAPTER - METRIC

Taper Size
HSK-A 50, 63 and 100

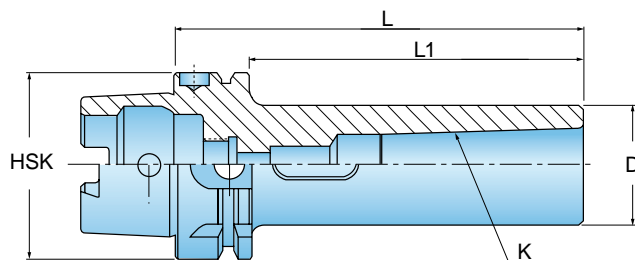
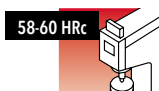
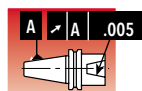

Designation	HSK-A	K	D	L	L1
HSK A 50 MT1X100	50	MT1	25	100	74
HSK A 50 MT2X120	50	MT2	32	120	94
HSK A 50 MT3X140	50	MT3	40	140	114
HSK A 63 MT1X110	63	MT1	25	110	84
HSK A 63 MT2X120	63	MT2	32	120	94
HSK A 63 MT3X140	63	MT3	40	140	114
HSK A 63 MT4X160	63	MT4	48	160	134
HSK A 100 MT1X110	100	MT1	25	110	81
HSK A 100 MT2X120	100	MT2	32	120	91
HSK A 100 MT3X150	100	MT3	40	150	121
HSK A 100 MT4X170	100	MT4	48	170	141
HSK A 100 MT5X200	100	MT5	63	200	171

* Balanced to G2.5 35,000RPM



HSK - SHORT ER COLLET CHUCK - METRIC

Taper Size
HSK-A 63 and 100

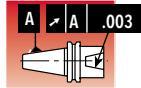

G2.5
20,000 RPM

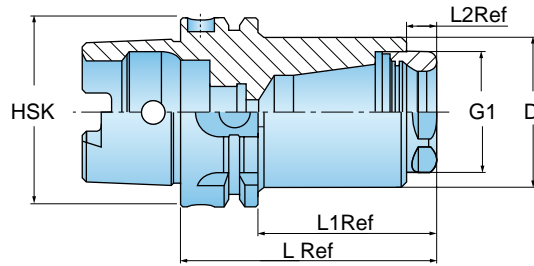

Designation	HSK-A	Range	D	L	L1	L2	G1
HSKA63ER32SHORT	63	2-20	50	84.5	56.1	9.5	M40x1.5
HSKA100ER32SHORT	100	2-20	50	89.5	60.5	9.5	M40x1.5
HSKA100ER40SHORT	100	3-26	70	104.5	75.5	9.5	M50x1.5

HSK - BLANK - METRIC

Taper Size
HSK-A 50, 63 and 100

58-60 HRC

√ N5

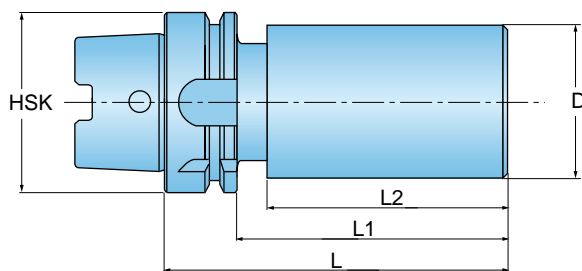

Designation	HSK-A	D	D1	L	L1	L2
HSK A 50 B16MN 100	50	53	41.8	100	74	58.0
HSK A 50 B16MN 200	50	53	41.8	200	174	158.0
HSK A 63 B16MN 100	63	63	52.8	100	74	55.5
HSK A 63 B16MN 200	63	63	52.8	200	174	155.5
HSK A 100 B16MN 100	100	102	85.0	100	71	54.8
HSK A 100 B16MN 200	100	102	85.0	200	171	154.8

Material: Case hardened alloy steel.
Shank hardness 58 HRC minimum.
Nose hardness 35-37 HRC.

Ingersoll



CUTTING TOOLS

CUTTING TOOLS

CAT TOOLHOLDERS.

Cutting Tools



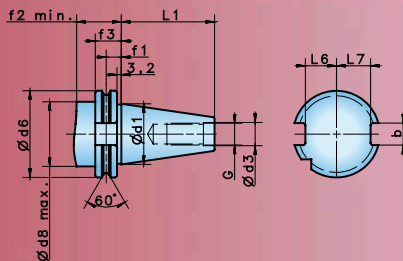

Member IMC Group
Ingersoll
Cutting Tools

CAT TOOLHOLDERS.

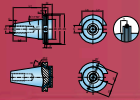
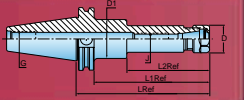
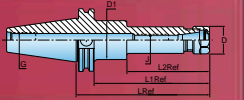
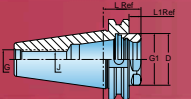

Kegel	d ₁ (mm)	d ₃ (mm)	d ₆ (mm)	d _{8 max.} (mm)	f _{2 min.} (mm)	f ₃ (mm)	L ₁ (mm)	L ₆ (mm)	L ₇ (mm)	G
SK 40	44,45	17	63,55	50	35	19,1	68,4	22,8	25	M16
SK 50	69,85	25	97,5	80	35	19,1	101,75	35,5	37,7	M24
SK 60	107,95	32	155	130	38	19,1	161,8	54,5	59,3	M30

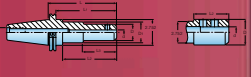
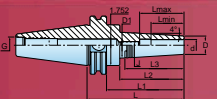
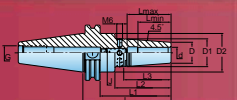
Product	Series	Page
 CAT - Toolholder Standard	CAT30	778
 CAT - ER Collet Chuck	CAT30/40/50-ER16/20/25/50	779
 CAT - ER Collet Chuck	CAT30/40/50-ER25/32/40/50	780
 CAT - Short End Mill Holder	CAT40-EM3/8, 1/2, 5/8, 3/4, 1, 1 1/4	781
 CAT - End Mill Holder	CAT40-M3/16, 1/4, 3/8, 1/2, 5/8, 3/4, 7/8, 1, 1 1/4, 1 1/2	782
 CAT - Endmill Holder	CAT50-EM1/4, 3/8, 1/2, 5/8, 3/4, 7/8, 1, 1 1/4, 1 1/2, 2	783
 CAT - Thermal Shrink Holder	CAT40-SRK1/8, 3/16, 1/4, 5/16, 3/8, 7/16, 1/2	784
 CAT - Thermal Shrink Holder	CAT40/50-SRKIN 1/4, 5/16, 3/8, 7/16, 1/2, 5/8, 3/4, 7/8, 1, 1 1/4	785

	Product	Series	Page
	CAT - Shell Mill Adapter	CAT40/50-SEM1/2, 3/4, 1, 1 1/4, 1 1/2, 2	786
	CAT - CAT*SEM*C Shell Mill Holder Coolant Thru	CAT40/50-SEM1/2, 3/4, 1, 1 1/4, 1 1/2-C	787
	CAT - Face Mill Holder	CAT50-FM2 1/2	788
	CAT - Stub Arbor Holder	CAT40/50-STUB1, 1 1/4, 1 1/2, 2	789
	CAT - Drill Chuck Arbor	CAT40/50-DC-J2/3/4/5/6	790
	CAT - Adapter	CAT50-AD-ISO	791
	CAT - Morse Taper Adapter	CAT40/50-MT1/2/3/4/5	792
	CAT - Center Alignment Collet Chuck	ADJ-CAT40/50-ER32	793
	CAT - Center Alignment Shank and Base	ADJ-CAT40/50-D2.756	794

CAT - TOOLHOLDER STANDARD

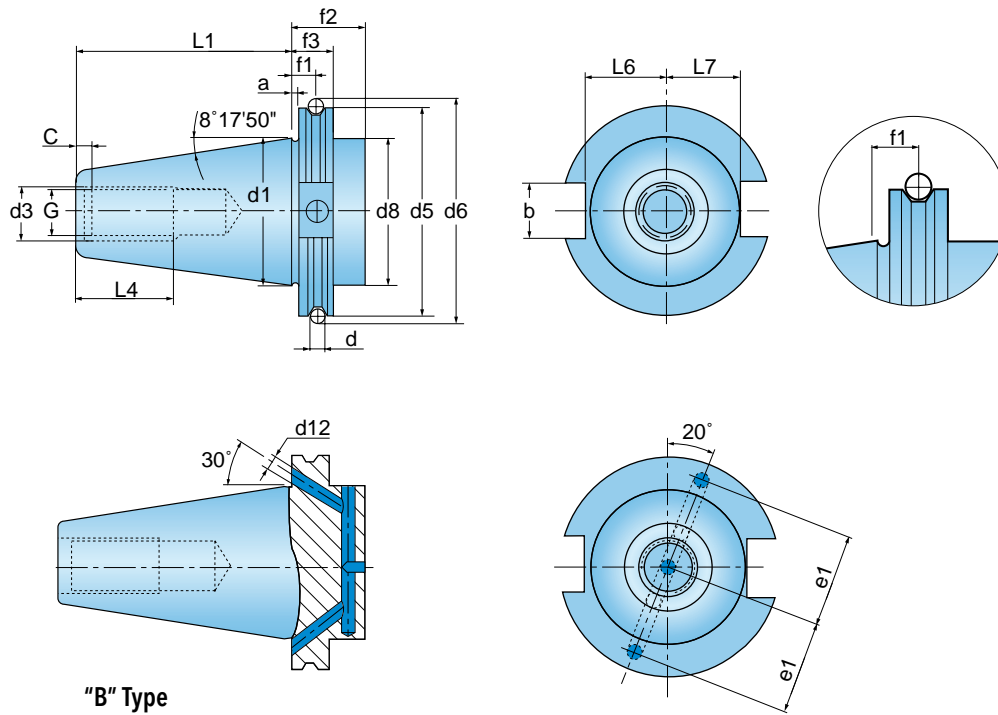

CAT A.N.S.I. B5.50

Shank	b ±.001	d	d1	G UNC-2B	d3 ±.01	C ±.01	d6 ±.002	d5 ±.002	d8 ±.005	f1 ±.005
CAT 30	.645	.2756	1.250	1/2-13	.590	.188	2.176	1.812	1.250	.4375
CAT 40	.645	.2756	1.750	5/8-11	.720	.188	2.863	2.500	1.750	.4375
CAT 50	1.02	.2756	2.750	1-8	1.125	.250	4.238	3.875	2.750	.4375

Shank	f2 MIN	f3 ±.002	L1 ±.005	L4 MIN	L6 .000-.015	L7 .000-.015	e1 ±.004	d12	a
CAT 30	1.38	.750	1.875	1.000	.735	.640	.826	.157	.125
CAT 40	1.38	.750	2.687	1.120	.985	.890	1.062	.157	.125
CAT 50	1.38	.750	4.000	1.750	1.485	1.390	1.653	.236	.125

CAT - ER COLLET CHUCK

Taper Size
CAT-30, 40 and 50

G2.5
20,000 RPM

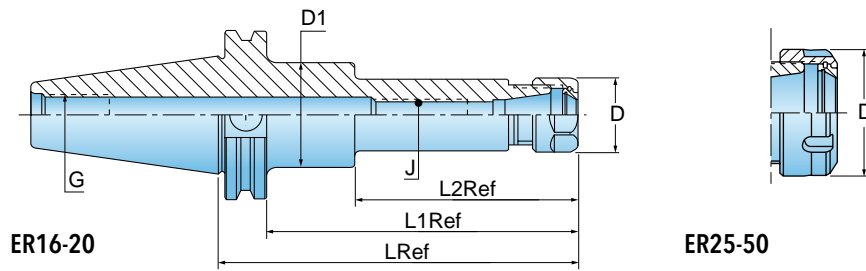
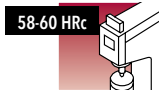
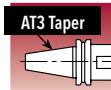
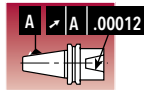

ER16-20

ER25-50

Designation	Range	L	L1	L2	D	D1	J	G
CAT30 ER16X2.750*	.022-.396	2.750	2.000	1.370	1.102	1.248	M10	1/2-13
CAT40 ER16X2.750	.022-.396	2.750	2.000	1.370	1.102	1.752	M12	5/8-11
CAT40 ER16X3.937	.022-.396	3.937	3.187	2.560	1.102	1.752	M12	5/8-11
CAT40 ER16X5.906	.022-.396	5.906	5.156	3.350	1.102	1.752	M12	5/8-11
CAT40 ER20X3.937	.041-.514	3.937	3.187	2.560	1.339	1.752	M12	5/8-11
CAT40 ER20X4.000	.041-.514	4.000	3.250	2.620	1.339	1.752	M12	5/8-11
CAT40 ER20X5.906	.041-.514	5.906	5.156	3.780	1.339	1.752	M12	5/8-11
CAT50 ER16X3.937*	.022-.396	3.937	3.187	2.560	1.102	2.752	M12	1-8
CAT50 ER16X5.906*	.022-.396	5.906	5.156	3.490	1.102	2.752	M12	1-8
CAT50 ER16X8.000*	.022-.396	8.000	7.250	2.980	1.102	2.752	M12	1-8
CAT50 ER20X3.937*	.041-.514	3.937	3.187	2.560	1.349	2.752	M16	1-8
CAT50 ER20X5.906*	.041-.514	5.906	5.156	4.530	1.349	2.752	M16	1-8
CAT50 ER20X8.000*	.041-.514	8.000	7.250	4.620	1.339	2.752	M16	1-8

Add B for internal coolant flange.
*Balance to G6.3 12000 RPM.

CAT - ER COLLET CHUCK

Taper Size
CAT-30, 40 and 50

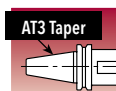
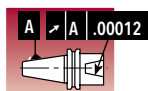

G2.5
20,000 RPM

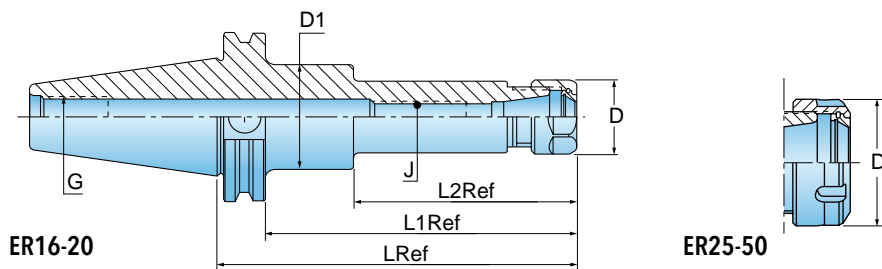

Designation	Range	L	L1	L2	D	D1	J	G
CAT30 ER32X3.268*	.080-.789	3.268	2.518	1.890	1.968	1.248	M18X1.5	1/2-13
CAT40 ER25X2.562	.041-.632	2.562	1.812	1.180	1.654	1.752	M16	5/8-11
CAT40 ER25X4.000	.041-.632	4.000	3.250	2.620	1.654	1.752	M16	5/8-11
CAT40 ER25X6.000	.041-.632	6.000	5.250	4.620	1.654	1.752	M16	5/8-11
CAT40 ER32X2.562	.080-.789	2.562	1.812	-	1.968	1.752	M22X1.5	5/8-11
CAT40 ER32X 4.000	.080-.789	4.000	3.250	-	1.968	1.752	M22X1.5	5/8-11
CAT40 ER32X 6.000	.080-.789	6.000	5.250	-	1.968	1.752	M22X1.5	5/8-11
CAT40 ER40X3.359	.120-1.025	3.359	2.609	-	2.480	1.752	M28X1.5	5/8-11
CAT40 ER40X 4.000	.120-1.025	4.000	3.250	-	2.480	1.752	M28X1.8	5/8-11
CAT50 ER25X4.000*	.041-.632	4.000	3.250	2.580	1.654	2.752	M16	1-8
CAT50 ER25X6.000*	.041-.632	6.000	5.250	4.620	1.654	2.752	M16	1-8
CAT50 ER25X8.000*	.041-.632	8.000	7.250	6.580	1.654	2.752	M16	1-8
CAT50 ER32X4.000*	.080-.789	4.000	3.250	2.540	1.968	2.752	M22X1.5	1-8
CAT50 ER32 X6.000*	.080-.789	6.000	5.250	4.580	1.968	2.752	M22X1.5	1-8
CAT50 ER32 X8.000*	.080-.789	8.000	7.250	6.580	1.968	2.752	M22X1.5	1-8
CAT50 ER40 X4.000*	.120-1.025	4.000	3.250	2.620	2.480	2.752	M28X1.5	1-8
CAT50 ER40 X6.000*	.120-1.025	6.000	5.250	4.620	2.480	2.752	M28X1.5	1-8
CAT50 ER40 X8.000*	.120-1.025	8.000	7.250	6.580	2.480	2.752	M28X1.5	1-8
CAT50 ER50 X4.000*	.396-1.338	4.000	3.250	-	3.070	2.752	M36X1.5	1-8
CAT50 ER50 X6.000*	.396-1.338	6.000	5.250	-	3.070	2.752	M36X1.5	1-8

Add B for internal coolant flange.

*Balance to G6.3 12000 RPM.

CAT - SHORT ENDMILL HOLDER

Taper Size
CAT-40

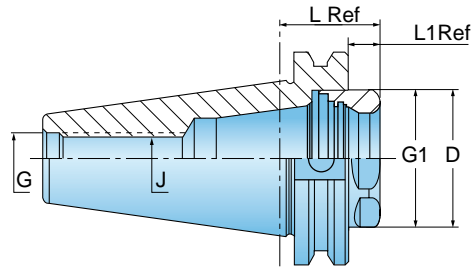
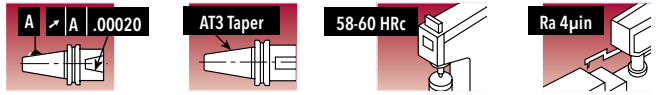

Designation	d	L	L1	D	G
CAT40 EM 3/8X1.750	.375	1.750	1.000	1.500	5/8-11
CAT40 EM 1/2X1.750	.500	1.750	1.000	1.500	5/8-11
CAT40 EM 5/8X1.750	.625	1.750	1.000	1.500	5/8-11
CAT40 EM 3/4X1.750	.750	1.750	1.000	1.750	5/8-11
CAT40 EM 1X1.750	1.000	1.750	1.000	2.000	5/8-11
CAT40 EM 1-1/4X2.000	1.250	2.000	1.250	2.250	5/8-11

CAT - ENDMILL HOLDER

Taper Size
CAT-40

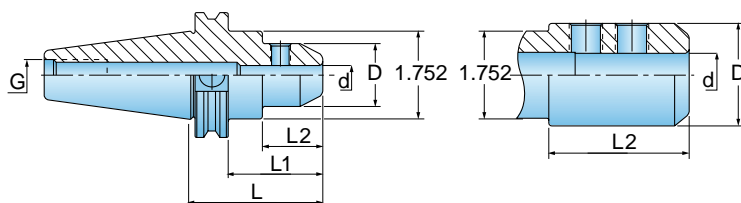

Designation	d	L	L1	L2	D	G
CAT40 EM 3/16X2.500	.187	2.500	1.750	1.121	.866	5/8-11
CAT40 EM 1/4X2.500	.250	2.500	1.750	1.121	1.000	5/8-11
CAT40 EM 3/8X2.500	.375	2.500	1.750	1.121	1.248	5/8-11
CAT40 EM 1/2X2.625	.500	2.625	1.875	-	-	5/8-11
CAT40 EM 5/8X3.750	.625	3.750	3.000	-	-	5/8-11
CAT40 EM 3/4X3.750	.750	3.750	3.000	-	-	5/8-11
CAT40 EM 7/8X4.000	.875	4.000	3.250	2.620	2.047	5/8-11
CAT40 EM 1X4.000	1.000	4.000	3.250	2.620	2.559	5/8-11
CAT40 EM 1-1/4X4.250	1.250	4.250	3.500	2.870	2.752	5/8-11
CAT40 EM 1-1/2X4.625	1.500	4.625	3.875	3.245	3.150	5/8-11

Add B for internal coolant flange.

CAT - ENDMILL HOLDER

Taper Size
CAT-50

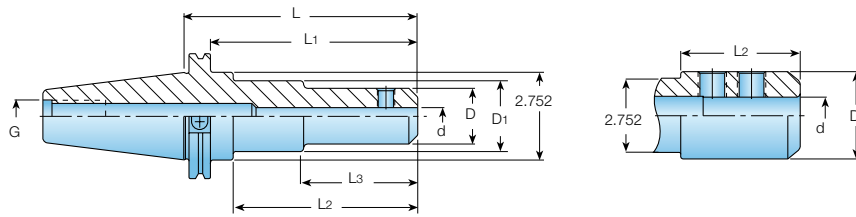
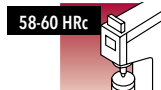
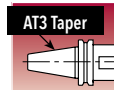
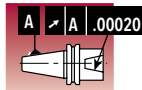

Designation	d	L	L1	L2	L3	D	D1	G
CAT50 EM 1/4 X2.500	.250	2.500	1.750	1.120	-	1.000	-	1-8
CAT50 EM 1/4 X4.500	.250	4.500	3.750	3.150	-	1.000	-	1-8
CAT50 EM 1/4 X6.250	.250	6.250	5.500	4.870	2.756	1.000	1.969	1-8
CAT50 EM 3/8 X2.500	.375	2.500	1.750	1.120	-	1.248	-	1-8
CAT50 EM 3/8 X4.500	.375	4.500	3.750	3.120	-	1.248	-	1-8
CAT50 EM 3/8X6.500	.375	6.500	5.500	5.120	3.130	1.248	1.969	1-8
CAT50 EM 1/2 X2.625	.500	2.625	1.875	1.245	-	1.752	-	1-8
CAT50 EM 1/2 X4.625	.500	4.625	3.875	3.245	-	1.752	-	1-8
CAT50 EM 1/2X6.625	.500	6.625	5.875	5.245	3.248	1.752	2.205	1-8
CAT50 EM 5/8 X3.750	.625	3.750	3.000	2.370	-	1.752	-	1-8
CAT50 EM 5/8X5.750	.625	5.750	5.000	4.370	-	1.752	-	1-8
CAT50 EM 5/8X7.750	.625	7.750	7.000	6.370	4.390	1.752	2.165	1-8
CAT50 EM 3/4 X3.750	.750	3.750	3.000	2.370	-	1.772	-	1-8
CAT50 EM 3/4 X5.750	.750	5.750	5.000	3.150	-	1.772	-	1-8
CAT50 EM 3/4X7.750	.750	7.750	7.000	6.370	3.150	1.772	2.264	1-8
CAT50 EM 7/8 X3.750	.875	3.750	3.000	2.370	-	2.047	-	1-8
CAT50 EM 7/8X5.750	.875	5.750	5.000	3.150	-	2.047	-	1-8
CAT50 EM 7/8X7.750	.875	7.750	7.000	3.150	-	2.047	-	1-8
CAT50 EM 1 X4.000	1.000	4.000	3.250	2.620	-	2.559	-	1-8
CAT50 EM 1 X6.000	1.000	6.000	5.250	4.620	-	2.559	-	1-8
CAT50 EM 1 X8.000	1.000	8.000	7.250	4.625	-	2.559	-	1-8
CAT50 EM 1-1/4X4.000	1.250	4.000	3.250	-	-	-	-	1-8
CAT50 EM 1-1/4X6.000	1.250	6.000	5.250	-	-	-	-	1-8
CAT50 EM 1-1/4X8.000	1.250	8.000	7.250	-	-	-	-	1-8
CAT50 EM 1-1/2X4.000	1.500	4.000	3.250	2.620	-	3.150	-	1-8
CAT50 EM 1-1/2X6.000	1.500	6.000	5.250	4.620	-	3.150	-	1-8
CAT50 EM 1-1/2X8.000	1.500	8.000	7.250	6.620	-	3.150	-	1-8
CAT50 EM 2 X5.625	2.000	5.625	4.875	4.245	-	3.740	-	1-8

Add B for internal coolant flange.

CAT - THERMAL SHRINK HOLDER

Taper Size
CAT-40

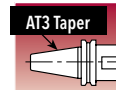
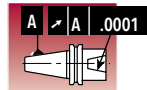

G2.5
25,000 RPM

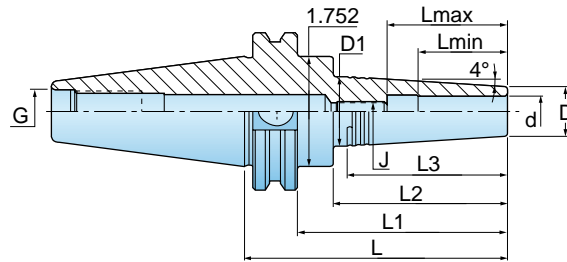

CARBIDE ONLY

Designation	d	D	D1	L	L1	L2	L3	Lmin	Lmax	J	G	Hex Key*
CAT40 SRK 1/8x2.000	.125	.394	.591	3.380	2.630	2.000	1.400	.394	.630	M6	5/8-11	3
CAT40 SRK 1/8x3.250	.125	.394	.748	4.630	2.880	3.250	2.526	.394	.630	M6	5/8-11	3
CAT40 SRK 3/16x2.000	.188	.394	.591	3.380	2.630	2.000	1.400	.591	.827	M6	5/8-11	3
CAT40 SRK 3/16x3.250	.188	.394	.748	4.630	2.880	3.250	2.526	.591	.827	M6	5/8-11	3
CAT40 SRK 1/4x2.000	.250	.433	.630	3.380	2.630	2.000	1.398	.709	.945	M8	5/8-11	4
CAT40 SRK 1/4x3.250	.250	.433	.787	4.630	2.880	3.250	2.524	.709	.945	M8	5/8-11	4
CAT40 SRK 5/16x2.000	.313	.551	.787	3.380	2.630	2.000	1.673	.984	1.220	M10	5/8-11	5
CAT40 SRK 5/16x3.250	.313	.551	.906	4.630	2.880	3.250	2.518	.984	1.220	M10	5/8-11	5
CAT40 SRK 3/8x2.000	.375	.630	.866	3.380	2.630	2.000	1.669	1.181	1.417	M12	5/8-11	6
CAT40 SRK 3/8x3.250	.375	.630	.965	4.630	2.880	3.250	2.373	1.181	1.417	M12	5/8-11	6
CAT40 SRK 7/16x2.000	.438	.787	1.024	3.380	2.630	2.000	1.665	1.220	1.614	M10	5/8-11	5
CAT40 SRK 7/16x3.250	.438	.787	1.102	4.630	2.880	3.250	2.228	1.220	1.614	M10	5/8-11	5
CAT40 SRK 1/2x2.000	.500	.787	1.024	3.380	2.630	2.000	1.665	1.260	1.654	M10	5/8-11	5
CAT40 SRK 1/2x3.250	.500	.787	1.102	4.630	2.880	3.250	2.228	1.260	1.654	M10	5/8-11	5

* Metric

CAT - THERMAL SHRINK HOLDER

Taper Size
CAT-40 and 50

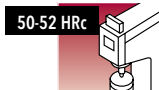
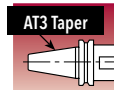
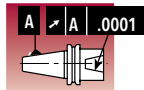

G2.5
25,000 RPM

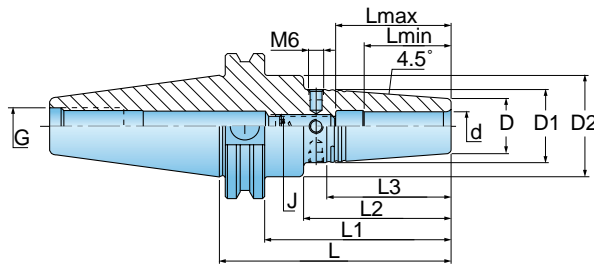

Designation	d	D	D1	D2	L	L1	L2	L3	Lmin	Lmax	J	G	Hex Key *
CAT40 SRKIN 1/4X3.500	.250	.827	1.063	1.752	3.500	2.750	2.120	1.501	.984	1.417	M5	5/8-11	2.5
CAT40 SRKIN 5/16X3.500	.313	.827	1.063	1.752	3.500	2.750	2.120	1.501	.984	1.417	M6	5/8-11	3.0
CAT40 SRKIN 3/8 X3.750	.375	.945	1.260	1.752	3.750	3.000	2.370	2.000	1.220	1.654	M8	5/8-11	4.0
CAT40 SRKIN 7/16X3.750	.438	.945	1.260	1.752	3.750	3.000	2.370	2.001	1.417	1.850	M10	5/8-11	5.0
CAT40 SRKIN 1/2 X3.750	.500	.945	1.260	1.752	3.750	3.000	2.370	2.001	1.417	1.850	M10	5/8-11	5.0
CAT40 SRKIN 5/8 X3.750	.625	1.063	1.339	1.752	3.750	3.000	2.370	1.751	1.535	1.969	M12	5/8-11	6.0
CAT40 SRKIN 3/4 X4.000	.750	1.299	1.654	1.752	4.000	3.250	2.620	2.251	1.614	2.047	M16	5/8-11	8.0
CAT40 SRKIN 7/8 X4.000	.875	1.732	2.087	1.752	4.000	3.250	2.620	2.251	1.614	2.047	M16	5/8-11	8.0
CAT40 SRKIN 1 X4.000	1.000	1.732	2.087	1.752	4.000	3.250	2.620	2.251	1.850	2.283	M16	5/8-11	8.0
CAT40 SRKIN 1-1/4 X4.000	1.250	1.732	2.087	1.752	4.000	3.250	2.620	2.251	1.850	2.283	M16	5/8-11	8.0
CAT50 SRKIN 1/4 X3.500**	.250	.827	1.063	2.752	3.500	2.750	2.120	1.501	.984	1.417	M5	1-8	2.5
CAT50 SRKIN 5/16X3.500**	.313	.827	1.063	2.752	3.500	2.700	2.120	1.501	.984	1.417	M6	1-8	3.0
CAT50 SRKIN 3/8 X3.750**	.375	.945	1.260	2.752	3.750	3.000	2.370	2.000	1.220	1.654	M8	1-8	4.0
CAT50 SRKIN 7/16X3.750**	.438	.945	1.260	2.752	3.750	3.000	2.370	2.001	1.417	1.850	M10	1-8	5.0
CAT50 SRKIN 1/2 X3.750**	.500	.945	1.260	2.752	3.750	3.000	2.370	2.001	1.417	1.850	M10	1-8	5.0
CAT50 SRKIN 5/8 X3.750**	.625	1.063	1.339	2.752	3.750	3.000	2.620	1.751	1.535	1.969	M12	1-8	6.0
CAT50 SRKIN 3/4 X4.000**	.750	1.299	1.654	2.752	4.000	3.250	2.620	2.251	1.614	2.047	M16	1-8	8.0
CAT50 SRKIN 7/8 X4.000**	.875	1.732	2.087	2.752	4.000	3.250	2.620	2.251	1.614	2.047	M16	1-8	8.0
CAT50 SRKIN 1 X4.000**	1.000	1.732	2.087	2.752	4.000	3.250	2.620	2.251	1.850	2.283	M16	1-8	8.0
CAT50 SRKIN 1-1/4 X4.000**	1.250	1.732	2.087	2.752	4.000	3.250	2.620	2.251	1.850	2.283	M16	1-8	8.0

* Metric

** Balanced to G2.5 20,000RPM.

CAT - SHELL MILL ADAPTER

Taper Size
CAT-40 and 50

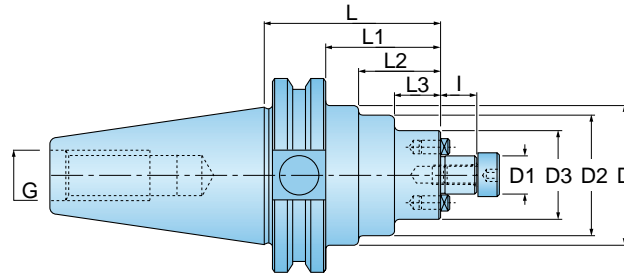
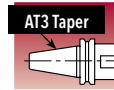
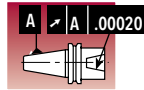

Designation	D1	D	D2	D3	L	L1	L2	L3	I	G
CAT40 SEM 1/2X1.500	.500	1.750	1.378	-	1.500	.750	.102	-	.571	5/8-11
CAT40 SEM 3/4X1.375	.750	1.752	-	-	1.375	.625	-	-	.669	5/8-11
CAT40 SEM 1X2.062	1.000	1.752	2.165	-	2.062	1.312	.682	-	.669	5/8-11
CAT40 SEM 1-1/4X2.125	1.250	1.752	2.752	-	2.125	1.375	.745	-	.669	5/8-11
CAT40 SEM 1-1/2X2.406	1.500	1.752	3.071	-	2.406	1.656	1.026	-	.938	5/8-11
CAT50 SEM 1/2X3.500	.500	2.752	1.378	-	3.500	2.750	2.120	-	.571	1-8
CAT50 SEM 1/2X5.500	.500	2.752	1.378	-	5.500	4.750	4.120	-	.571	1-8
CAT50 SEM 3/4X1.500	.750	2.752	1.772	-	1.500	.750	.120	-	.669	1-8
CAT50 SEM 3/4X3.500	.750	2.752	1.772	-	3.500	2.750	2.102	-	.669	1-8
CAT50 SEM 3/4X5.500	.750	2.752	2.362	1.772	5.500	4.750	4.130	2.480	.669	1-8
CAT50 SEM 3/4X1.920X8.00	.750	2.752	1.920	-	8.000	7.250	6.583	-	.669	1-8
CAT50 SEM 1X2.000	1.000	2.752	2.165	-	2.000	1.250	.620	-	.669	1-8
CAT50 SEM 1X4.000	1.000	2.752	2.165	-	4.000	3.250	.728	-	.669	1-8
CAT50 SEM 1X6.000	1.000	2.752	2.165	-	6.000	5.250	2.657	-	.669	1-8
CAT50 SEM 1X2.42X12.00	1.000	2.752	2.420	-	12.000	11.250	10.583	-	.669	1-8
CAT50 SEM 1-1/4X1.500	1.250	2.752	-	-	1.500	.750	-	-	.669	1-8
CAT50 SEM 1-1/4X3.500	1.250	2.752	-	-	3.500	2.750	-	-	.669	1-8
CAT50 SEM 1-1/4X4.000	1.250	2.752	-	-	4.000	3.250	-	-	.669	1-8
CAT50 SEM 1-1/4X2.92X13.0	1.250	2.752	2.921	-	13.000	12.250	11.620	-	.669	1-8
CAT50 SEM 1-1/4X6.000	1.250	2.752	-	-	6.000	5.250	-	-	.669	1-8
CAT50 SEM 1-1/2X2.406	1.500	2.752	3.071	-	2.406	1.656	1.026	-	.938	1-8
CAT50 SEM 1-1/2X4.000	1.500	2.752	3.071	-	4.000	3.250	2.620	-	.938	1-8
CAT50 SEM 1-1/2X6.000	1.500	2.752	3.071	-	6.000	5.250	4.620	-	.938	1-8
CAT50 SEM 2X2.406	2.000	2.752	3.858	-	2.406	1.656	1.026	-	.938	1-8
CAT50 SEM 2X4.000	2.000	2.752	3.858	-	4.000	3.250	2.620	-	.938	1-8

CAT - SERIES CAT*SEM*C

Taper Size
CAT-40 and 50

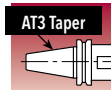
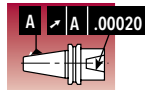

Shell Mill Holder Coolant Thru - DIN AD + B

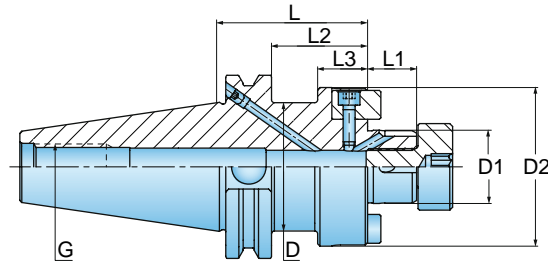

Designation	D1	D	D2	L	L1	L2	L3	G
CAT 40 SEM 1/2x2.000 C	0.500	1.752	1.475	2.000	.570	1.250	-	5/8x11
CAT 40 SEM 3/4x1.375 C	0.750	1.752	-	1.375	.669	.625	-	5/8x11
CAT 40 SEM 1X2.062 C	1.000	1.752	2.165	2.062	.669	1.312	.682	5/8x11
CAT 40 SEM 1-1/4X2.125 C	1.250	1.752	2.752	2.125	.669	1.375	.745	5/8x11
CAT 40 SEM 1-1/2X2.406 C	1.500	1.752	3.071	2.406	.937	1.656	1.026	5/8x11
CAT 50 SEM 1/2x3.500 C	0.500	2.752	1.475	3.500	.570	2.750	-	1x8
CAT 50 SEM 1/2x5.500 C	0.500	2.752	1.475	5.500	.570	4.750	-	1x8
CAT 50 SEM 3/4x2.000 C	0.750	2.752	1.772	2.000	.669	1.250	.620	1x8
CAT 50 SEM 3/4x3.500 C	0.750	2.752	1.772	3.500	.669	2.750	2.120	1x8
CAT 50 SEM 3/4x5.500 C	0.750	2.752	1.772	5.500	.669	4.750	4.120	1x8
CAT 50 SEM 1x2.000 C	1.000	2.752	2.165	2.000	.669	1.250	.620	1x8
CAT 50 SEM 1x4.000 C	1.000	2.752	2.165	4.000	.669	3.250	2.620	1x8
CAT 50 SEM 1-1/4x2.000 C	1.250	2.752	-	2.000	.669	1.250	.620	1x8
CAT 50 SEM 1-1/4x3.500 C	1.250	2.752	-	3.500	.669	2.750	2.120	1x8
CAT 50 SEM 1-1/2x2.500 C	1.500	2.752	3.071	2.500	.937	1.750	1.120	1x8
CAT 50 SEM 1-1/2x4.000 C	1.500	2.752	3.071	4.000	.937	3.250	2.620	1x8



CAT - FACE MILL HOLDER

Taper Size
CAT-50

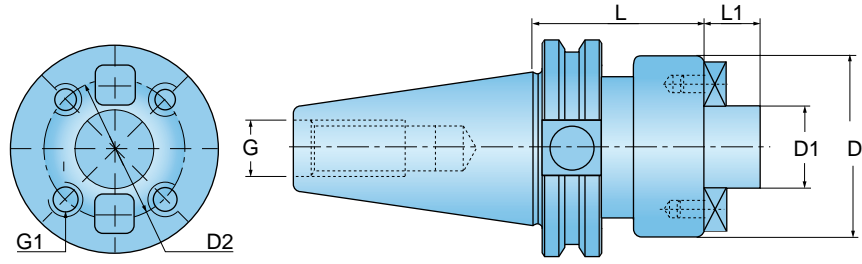
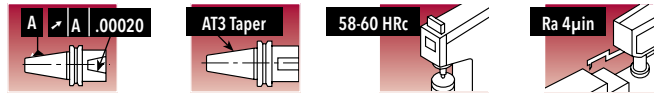

Designation	D1	L	L1	D	D2	G	G1
CAT50 FM2-1/2X2.875	2.500	2.875	1.125	4.881	4.00	1-8	5/8-11

CAT - STUB ARBOR HOLDER

Taper Size
CAT-40 and 50

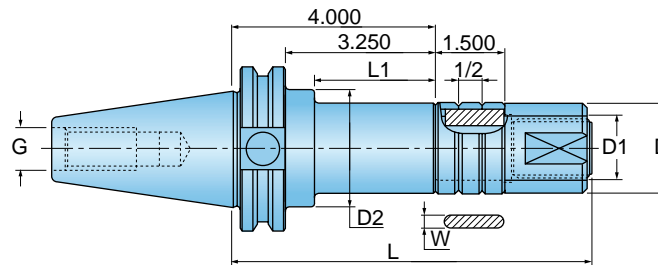
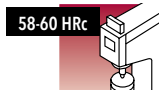
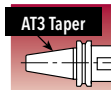
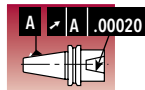

Designation	D1	D	D2	L	L1	W	G
CAT40 STUB 1X4.000	1.000	1.496	1.752	6.722	2.620	.250	5/8-11
CAT40 STUB 1-1/4X4.000	1.250	1.772	1.752	6.841	-	.312	5/8-11
CAT40 STUB 1-1/2X4.000	1.500	2.126	1.752	7.404	2.620	.375	5/8-11
CAT50 STUB 1 X4.000	1.000	1.496	2.752	6.717	2.620	.250	1-8
CAT50 STUB 1-1/4X4.000	1.250	1.772	2.752	6.835	2.620	.312	1-8
CAT50 STUB 1-1/2X4.000	1.500	2.126	2.752	7.404	2.620	.375	1-8
CAT50 STUB 2 X4.000	2.000	2.752	2.752	7.000	-	.500	1-8



CAT - DRILL CHUCK ARBOR

Taper Size
CAT-40 and 50

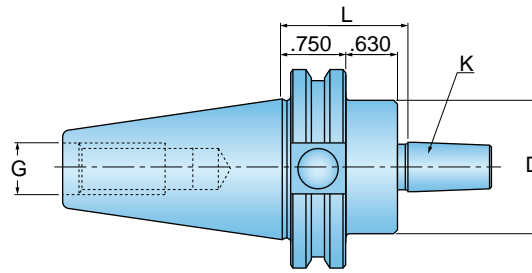
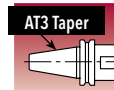
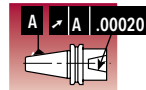

Designation	K	L	D	G
CAT40 DC J2X1.500	J2	1.500	1.752	5/8-11
CAT40 DC J3X1.500	J3	1.500	1.750	5/8-11
CAT40 DC J33X1.500	J33	1.500	1.752	5/8-11
CAT40 DC J4X1.500	J4	1.500	1.752	5/8-11
CAT40 DC J6X1.500	J6	1.500	1.752	5/8-11
CAT50 DC J2 X1.500	J2	1.500	2.752	1-8
CAT50 DC J3 X1.656	J3	1.656	2.752	1-8
CAT50 DC J33X1.500	J33	1.500	2.752	1-8
CAT50 DC J4 X1.500	J4	1.500	2.752	1-8
CAT50 DC J5 X1.625	J5	1.625	2.752	1-8
CAT50 DC J6 X1.500	J6	1.500	2.752	1-8

CAT - ADAPTER

Taper Size
CAT-50

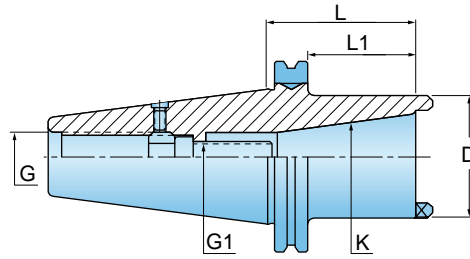
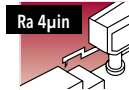
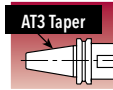
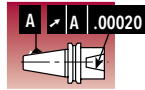

Designation	K	L	L1	D	G1	G
CAT50 AD ISO 40X70	ISO40	2.762	2.012	2.48	5/8-11	1-8



CAT - MORSE TAPER ADAPTER

Taper Size
CAT-40 and 50

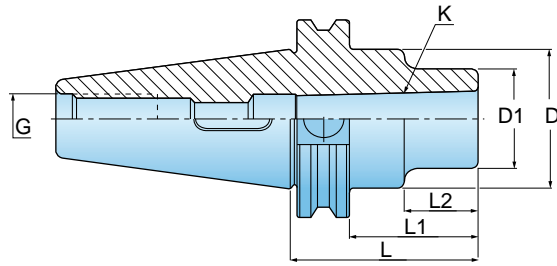
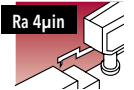
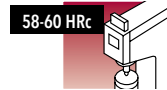
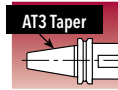
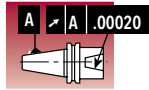

Designation	K	L	L1	L2	D	D1	G
CAT40 MT 1X1.750	MT1	1.750	1.000	.370	1.752	1.000	5/8-11
CAT40 MT 2X2.250	MT2	2.250	1.500	.870	1.752	1.260	5/8-11
CAT40 MT 3X2.765	MT3	2.765	2.015	-	1.752	-	5/8-11
CAT40 MT 4X3.625	MT4	3.625	2.875	2.245	1.752	2.008	5/8-11
CAT50 MT 1X1.500	MT1	1.500	.750	.120	2.752	1.000	1-8
CAT50 MT 2X2.000	MT2	2.000	1.250	.620	2.752	1.260	1-8
CAT50 MT 3X2.500	MT3	2.500	1.750	1.120	2.752	1.575	1-8
CAT50 MT 4X3.375	MT4	3.375	2.625	1.995	2.752	1.969	1-8
CAT50 MT 5X3.750	MT5	3.750	3.000	-	2.752	-	1-8

CAT - CENTER ALIGNMENT COLLET CHUCK

Taper Size
CAT-40 and 50

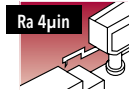
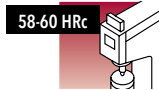
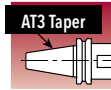
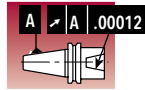

G2.5
20,000 RPM

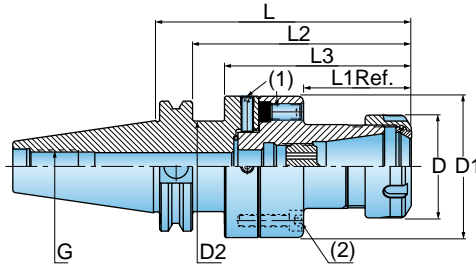

Designation	Range	L	L1	L2	L3	D	D1	D2	G	Hex Key(1) (mm)	Hex Key(2) (mm)
ADJCAT40D2.756ER32 .080-.789		4.902	2.067	4.152	3.522	1.969	2.756	1.752	5/8-11	4.0	5.0
ADJCAT50D2.756ER32 .080-.789		4.902	2.067	4.152	-	1.969	2.756	-	1-8	4.0	5.0



CAT - CENTER ALIGNMENT SHANK AND BASE

Taper Size
CAT-40 and 50

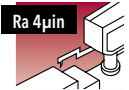
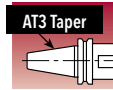
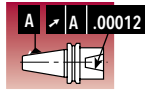

 **G2.5**
20,000 RPM

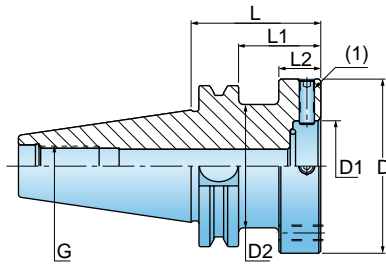

Designation	L	L1	L2	D	D1	D2	G	Hex Key(1) (mm)
ADJ CAT40 D2.756	1.969	1.219	.589	2.756	1.378	1.752	5/8-11	4.0
ADJ CAT50 D2.756	1.969	1.219	-	2.756	1.378	-	1-8	4.0



Ingersoll



CUTTING TOOLS
CUTTING TOOLS

BT TOOLHOLDERS.

Cutting Tools





BT TOOLHOLDERS.

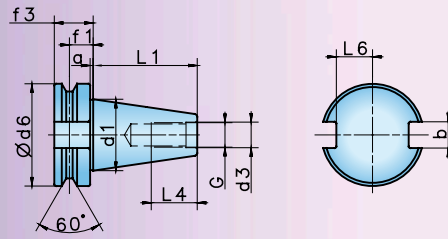

Taper	d ₁ (mm)	d ₃ (mm)	d ₆ (mm)	f ₁ (mm)	f ₃ (mm)	L ₁ (mm)	L ₄ (mm)	L ₆ (mm)	a (mm)	b (mm)	G
40	44,45	17	63	16,6	25	65,4	30	22,6	2	16,1	M16
50	69,85	25	100	23,2	35	101,8	45	35,4	3	25,7	M24

	Product	Series	Page
	BT - Toolholder Standard	BT40/50	800
	BT - ER Collet Chuck	BT30-ER16/20	801
	BT - ER Collet Chuck - Metric	BT30/40/50-ER25/32/40/50	802
	BT - Short ER Collet Chuck - Metric	BT30/40/50-ER20/32/40-SHORT	803
	BT - End Mill Holder Short Length	BT40-EM 3/8, 1/2, 5/8, 3/4, 1, 1 1/4	804
	BT - End Mill Holder	BT40/50-EM3/16, 1/4, 3/8, 1/2, 5/8, 3/4, 7/8, 1, 1 1/4, 1 1/2, 2	805
	BT - Thermal Shrink Holder - Metric	BT40/50-SRKIN6/8/10/12/14/16/18/20/25/32	806
	BT - Thermal Shrink Holder - Metric	BT40-SRK3/4/5/6/8/10/12	807

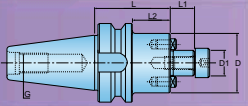
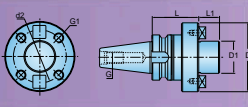
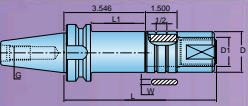
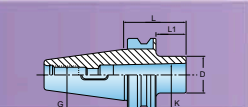
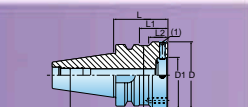
Product	Series	Page	
	BT - Shell Mill Holder	BT40/50-SEM 1/2, 3/4, 1, 1 1/4, 1 1/2, 2	808
	BT - Face Mill Holder	BT50-FM2 1/2	809
	BT - Stub Arbor Holder	BT40/50-STUB	810
	BT - Drill Chuck Arbor	BT40/50-DCJ	811
	BT - Morse Taper Adapter - Metric	BT30/40/50-MT1/2/3/4/5	812
	BT - Center Alignment Collet Chuck - Metric	ADJ-BT40/50-D70-ER32	813
	BT - Center Alignment Shank and Base - Metric	ADJ-BT40/50-D70	814

BT - TOOLHOLDER STANDARD

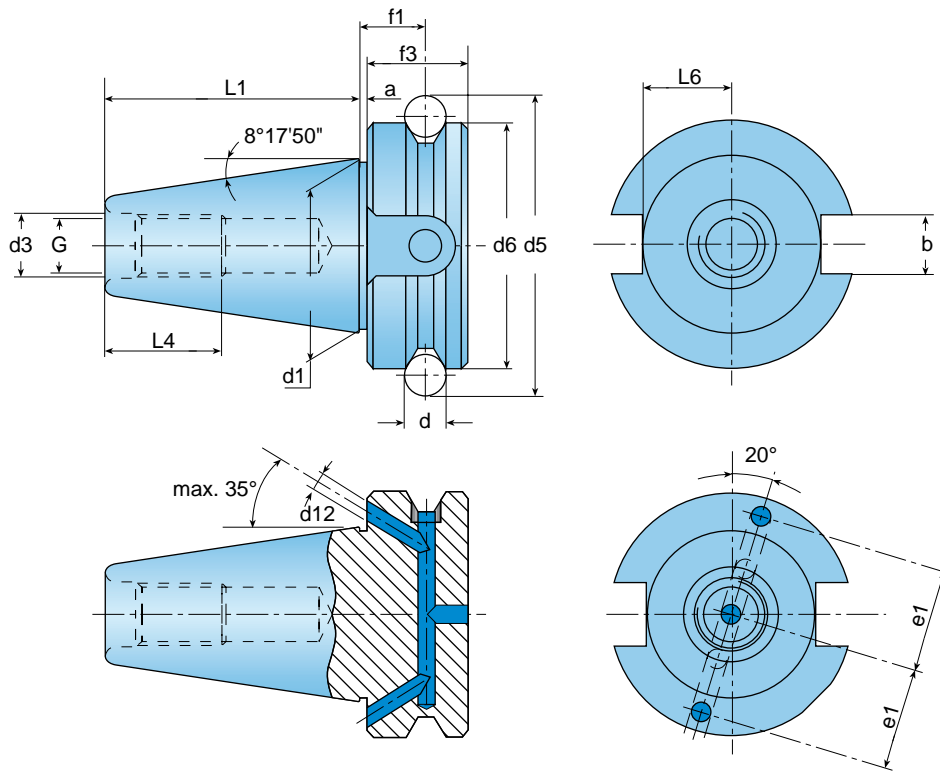

BT MAS 403

Shank	a	b (H12)	d	d1	G	d3 (H8)	d5	d6 (H8)	f1 ±0.1
BT 30	2	16.1	8	31.75	M12	12.5	56.144	46	13.6
BT 40	2	16.1	10	44.45	M16	17.0	75.679	63	16.6
BT 50	3	25.7	15	69.85	M24	25.0	119.020	100	23.2

Shank	f3	L1 ±0.2	L4 MIN	L6-0.2	e1 ±0.1	d12	TAPER AT3
BT 30	20	48.4	24	16.3	21	4	0.002
BT 40	25	65.4	30	22.6	27	4	0.003
BT 50	35	101.8	45	35.4	42	6	0.004

BT - ER COLLET CHUCK - METRIC

Taper Size
BT 30, 40 and 50

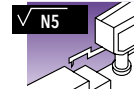
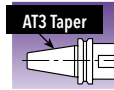
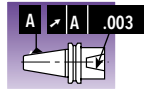

G2.5
20,000 RPM

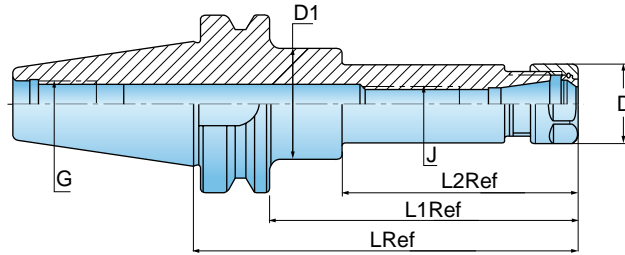

Designation	Range	L	L ₁	L ₂	D	D ₁	G	J
BT30 ER16X70*	0.5-10	70	48		28		M12	M10
BT30 ER16X100*	0.5-10	100	73		28		M12	M10
BT30 ER20X70*	1-13	70	48		34		M12	M12
BT40 ER16X70	0.5-10	70	43		28		M16	M12
BT40 ER16X100	0.5-10	100	73		28		M16	M12
BT40 ER16X150	0.5-10	150	123	110	28	40	M16	M12
BT40 ER16X200	0.5-10	200	173	85	28	40	M16	M10
BT40 ER20X70	1-13	70	43		34		M16	M12
BT40 ER20X100	1-13	100	73		34		M16	M12
BT40 ER20X120	1-13	120	93		34		M16	M12
BT40 ER20X150	1-13	150	123		34		M16	M12
BT50 ER16X100*	0.5-10	100	62		28		M24	M12
BT50 ER16X125*	0.5-10	125	87		28		M24	M12
BT50 ER16X150*	0.5-10	150	112		28		M24	M12
BT50 ER16X200*	0.5-10	200	162	85	28	40	M24	M10
BT50 ER20X100*	1-13	100	62		34		M24	M12
BT50 ER20X125*	1-13	125	87		34		M24	M12
BT50 ER20X150*	1-13	150	112		34		M24	M12
BT50 ER20X200*	1-13	200	162	85	34	50	M24	M12

Add B for coolant through the flange.
* Balanced to G6.3 at 12,000RPM

BT - ER COLLET CHUCK - METRIC

Taper Size
BT 30, 40 and 50



G2.5
20,000 RPM

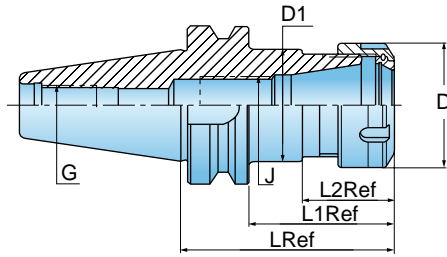

Designation	Range	L	L1	L2	D	D1	G	J
BT30 ER25X 60*	1-16	60	38		42		M12	M16
BT30 ER32X 60*	2-20	60	38		50		M12	M16
BT40 ER25X 60	1-16	60	33		42		M16	M16
BT40 ER25X100	1-16	100	73		42		M16	M16
BT40 ER25X150	1-16	150	123		42		M16	M16
BT40 ER32X 60	2-20	60	33		50		M16	M22x1.5
BT40 ER32X100	2-20	100	73		50		M16	M22x1.5
BT40 ER32X120	2-20	120	93		50		M16	M22x1.5
BT40 ER32X150	2-20	150	123		50		M16	M22x1.5
BT40 ER32X200	2-20	200	173		50		M16	M22x1.5
BT40 ER40X 80	3-26	80	53		63		M16	M28x1.5
BT40 ER40X100	3-26	100	73		63		M16	M28x1.5
BT40 ER40X150	3-26	150	123		63		M16	M28x1.5
BT40 ER40X200	3-26	200	173		63		M16	M28x1.5
BT40 ER50X 90	10-34	90	63		78		M16	M28x1.5
BT50 ER25X100*	1-16	100	62		42		M24	M16
BT50 ER25X150*	1-16	150	112		42		M24	M16
BT50 ER25X200*	1-16	200	162	87	42	55	M24	M16
BT50 ER32X100*	2-20	100	62		50		M24	M22x1.5
BT50 ER32X125*	2-20	125	87		50		M24	M22x1.5
BT50 ER32X150*	2-20	150	112		50		M24	M22x1.5
BT50 ER32X200*	2-20	200	162	88	50	63	M24	M22x1.5
BT50 ER40X100*	3-26	100	62		63		M24	M28x1.5
BT50 ER40X150*	3-26	150	112		63		M24	M28x1.5
BT50 ER40X200*	3-26	200	162		63		M24	M28x1.5
BT50 ER50X100*	10-34	100	62		78		M24	M36x1.5
BT50 ER50X150*	10-34	150	112		78		M24	M36x1.5

Add B for coolant through the flange.
* Balanced to G6.3 at 12,000 RPM

BT - SHORT ER COLLET CHUCK - METRIC

Taper Size
BT 30, 40 and 50

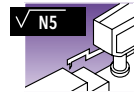
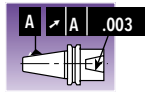

G2.5
20,000 RPM

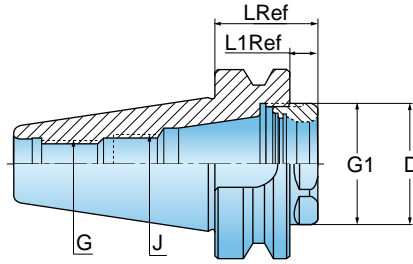

Designation	Range	L	L1	D	J	G	G1
BT30 ER20 SHORT	1-13	27.2	5.2	25	M12	M12	M25x1.5
BT40 ER32 SHORT	2-20	36.5	9.5	40	M16	M16	M40x1.5
BT40 ER40 SHORT	3-26	46.5	9.5	50	M16	M16	M50x1.5
BT50 ER32 SHORT	2-20	47.5	9.5	40	M22x1.5	M24	M40x1.5
BT50 ER40 SHORT	3-26	47.5	9.5	50	M28x1.5	M24	M50x1.5

Add B for coolant through the flange

BT - ENDMILL HOLDER SHORT LENGTH

Taper Size
BT-40

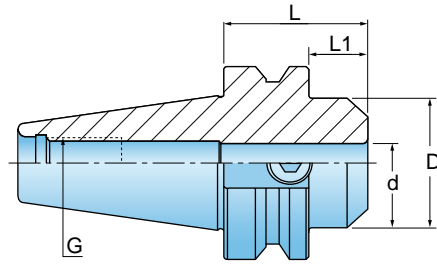
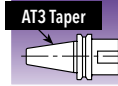
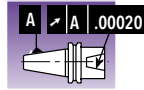

Designation	d	L	D	L1	G
BT40 EM 3/8 X1.750	.375	1.750	1.378	.687	M16
BT40 EM 1/2 X1.750	.500	1.750	1.654	.687	M16
BT40 EM 5/8 X1.750	.625	1.750	1.890	.687	M16
BT40 EM 3/4 X1.750	.750	1.750	2.047	.687	M16
BT40 EM 1 X1.750	1.000	1.750	2.480	-	M16
BT40 EM 1-1/4X2.000	1.250	2.000	2.480	-	M16

BT - ENDMILL HOLDER

Taper Size
BT-40 and 50

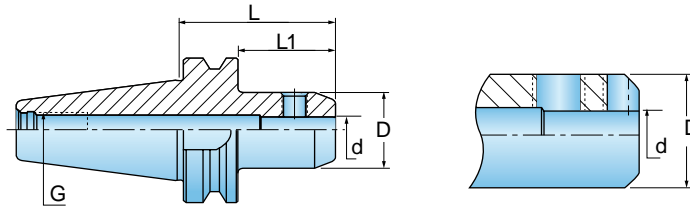
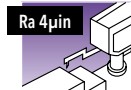
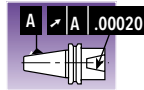

Designation	d	L	D	L1	G
BT30 EM 1/4X2.500	.250	2.500	1.000	1.630	M12
BT30 EM 3/8X2.500	.375	2.500	1.375	1.630	M12
BT30 EM 1/2X2.500	.500	2.500	1.650	1.630	M12
BT30 EM 3/4X2.500	.750	2.500	2.040	*	M12
BT30 EM 1X2.500	1.000	2.500	2.040	*	M12
BT40 EM 3/16X1.937	.188	1.937	.984	.906	M16
BT40 EM 1/4X2.375	.250	2.375	1.000	1.299	M16
BT40 EM 3/8X2.562	.375	2.562	1.378	1.496	M16
BT40 EM 1/2X2.562	.500	2.562	1.654	1.496	M16
BT40 EM 5/8X2.562	.625	1.750	1.890	1.496	M16
BT40 EM 7/8X4.125	.875	4.125	2.559	3.055	M16
BT40 EM 1X4.125	1.000	4.125	2.559	3.138	M16
BT40 EM 1-1/4x4.312	1.250	4.312	2.795	2.854	M16
BT40 EM 1-1/2X4.625	1.500	4.625	3.150	3.031	M16
BT50 EM 1/4X2.750	.250	2.750	1.000	1.260	M24
BT50 EM 3/8X2.750	.375	2.750	1.378	1.260	M24
BT50 EM 1/2X3.937	.500	3.937	1.654	2.441	M24
BT50 EM 5/8X3.937	.625	3.937	1.890	2.441	M24
BT50 EM 3/4X3.937	.750	3.937	2.047	2.441	M24
BT50 EM 1X4.500	1.000	4.500	2.559	3.031	M24
BT50 EM 1X4.500	1.000	4.500	2.559	3.031	M24
BT50 EM 1-1/4X4.500	1.250	4.500	2.835	3.031	M24
BT50 EM 1-1/2X4.500	1.500	4.500	3.150	3.031	M24
BT50 EM 2X4.937	2.000	4.937	3.859	3.441	M24

Add B for internal coolant flange

BT - THERMAL SHRINK HOLDER - METRIC

Taper Size
BT40 and 50

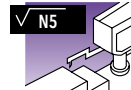
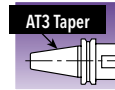
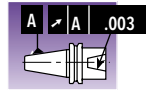

G2.5
25,000 RPM

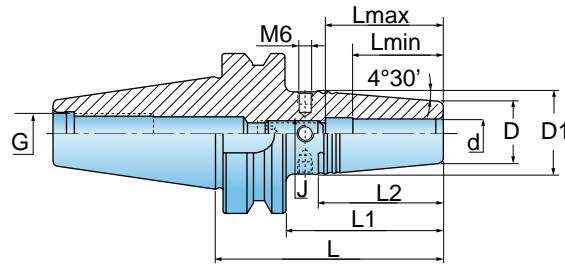

Designation	d	D1	D	L	L1	L2	Lmin	Lmax	J	G	Hex Key
BT40 SRKIN 6X 90	6	27	21	90	63	38.0	25	36	M5	M16	2.5
BT40 SRKIN 8X 90	8	27	21	90	63	38.0	25	36	M6	M16	3.0
BT40 SRKIN 10X 90	10	32	24	90	63	50.5	31	42	M8	M16	4.0
BT40 SRKIN 12X 90	12	32	24	90	63	50.5	36	47	M10	M16	5.0
BT40 SRKIN 14X 90	14	34	27	90	63	44.5	36	47	M10	M16	5.0
BT40 SRKIN 16X 90	16	34	27	90	63	44.5	39	50	M12	M16	6.0
BT40 SRKIN 18X 90	18	42	33	90	63	57.0	39	50	M12	M16	6.0
BT40 SRKIN 20X 90	20	42	33	90	63	57.0	41	52	M16	M16	8.0
BT40 SRKIN 25X110	25	53	44	110	83	57.0	47	58	M16	M16	8.0
BT50 SRKIN 6X100*	6	26	21	100	62	32.0	25	36	M5	M24	2.5
BT50 SRKIN 8X100*	8	27	21	100	62	38.0	25	36	M6	M24	3.0
BT50 SRKIN 10X100*	10	32	24	100	62	51.0	31	42	M8	M24	4.0
BT50 SRKIN 12X100*	12	32	24	100	62	51.0	36	47	M10	M24	5.0
BT50 SRKIN 14X100*	14	34	27	100	62	44.5	36	47	M10	M24	5.0
BT50 SRKIN 16X100*	16	34	27	100	62	44.5	39	50	M12	M24	6.0
BT50 SRKIN 18X100*	18	42	33	100	62	57.0	39	50	M12	M24	6.0
BT50 SRKIN 20X100*	20	42	33	100	62	57.0	41	52	M16	M24	8.0
BT50 SRKIN 25X120*	25	53	44	120	82	57.0	47	58	M16	M24	8.0
BT50 SRKIN 32X120*	32	53	44	120	82	57.0	47	58	M16	M24	8.0

* Balanced to G2.5 20,000 RPM
Use only inductive heating device for SRKIN holders

BT - THERMAL SHRINK HOLDER - METRIC

Taper Size
BT-40

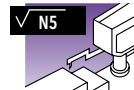
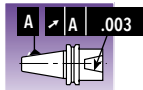

G2.5
25,000 RPM

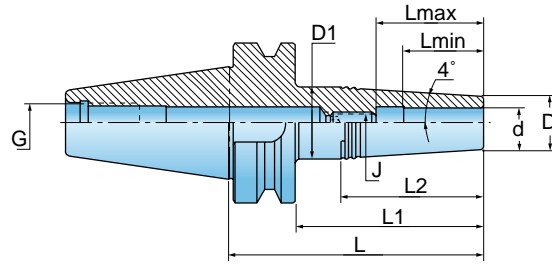

Designation	d	D	D1	L	L1	L2	Lmin	Lmax	J	G	Hex Key
BT 40 SRK 3X 50	3	10	15	77	50	35.5	10	16	M6	M16	3
BT 40 SRK 3X 85	3	10	19	112	85	64.1	10	16	M6	M16	3
BT 40 SRK 4X 50	4	10	15	77	50	35.5	12	18	M6	M16	3
BT 40 SRK 4X 85	4	10	19	112	85	64.1	12	18	M6	M16	3
BT 40 SRK 5X 50	5	10	15	77	50	35.5	15	21	M6	M16	3
BT 40 SRK 5X 85	5	10	19	112	85	64.1	15	21	M6	M16	3
BT 40 SRK 6X 50	6	11	16	77	50	35.5	18	24	M8	M16	4
BT 40 SRK 6X 85	6	11	20	112	85	64.1	18	24	M8	M16	4
BT 40 SRK 8X 50	8	14	20	77	50	42.5	25	31	M10	M16	5
BT 40 SRK 8X 85	8	14	23	112	85	63.9	25	31	M10	M16	5
BT 40 SRK 10X 50	10	16	22	77	50	42.4	30	36	M12	M16	6
BT 40 SRK 10X 85	10	16	25	112	85	60.2	30	36	M12	M16	6
BT 40 SRK 12X 50	12	20	26	77	50	42.3	32	42	M10	M16	5
BT 40 SRK 12X 85	12	20	28	112	85	56.6	32	42	M10	M16	5

BT - SHELL MILL HOLDER

Taper Size
BT-40 and 50

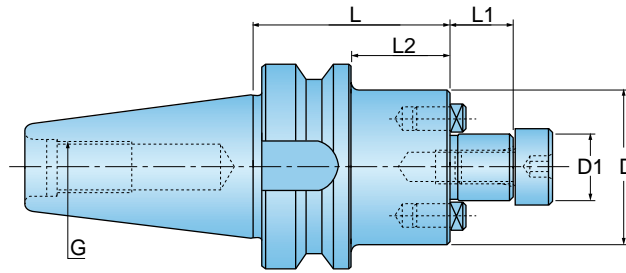

Designation	D1	D	L	L1	L2	G
BT30 SEM 1/2X2.500	.500	1.770	2.500	.670	*	M12
BT30 SEM 3/4X2.500	.750	1.770	2.500	.670	*	M12
BT40 SEM 1/2X2.375	.500	1.378	2.375	.571	.728	M16
BT40 SEM 3/4X2.375	.750	1.772	2.375	.669	1.299	M16
BT40 SEM 1X1.750	1.000	2.165	1.750	.669	.687	M16
BT40 SEM 1-1/4X2.375	1.250	2.520	2.375	.669	.906	M16
BT40 SEM 1-1/2X2.375	1.500	3.071	2.375	.937	.819	M16
BT50 SEM 3/4X2.937	.750	1.772	2.937	.669	1.441	M24
BT50 SEM 1X2.375	1.000	2.165	2.375	.669	.878	M24
BT50 SEM 1-1/4X1.875	1.250	2.520	1.875	.669	.394	M24
BT50 SEM 1-1/2X1.875	1.500	3.071	1.875	.937	.379	M24
BT50 SEM 2 X2.375	2.000	3.859	2.375	.937	.879	M24

BT - FACE MILL HOLDER

Taper Size
BT-50

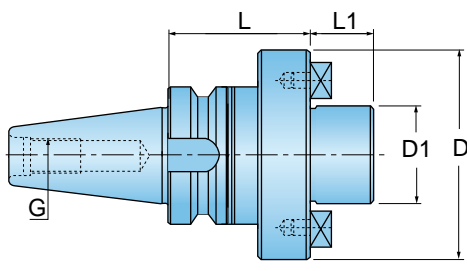
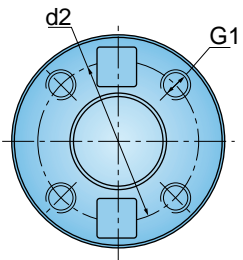
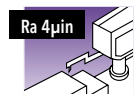
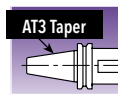
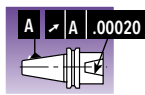

Designation	D1	L	L1	D	d2	G1	G
BT50 FM2-1/2X3.469	2.500	3.469	1.125	5.062	4.000	5/8-11	M24



BT - STUB ARBOR HOLDER

Taper Size
BT-40 and 50

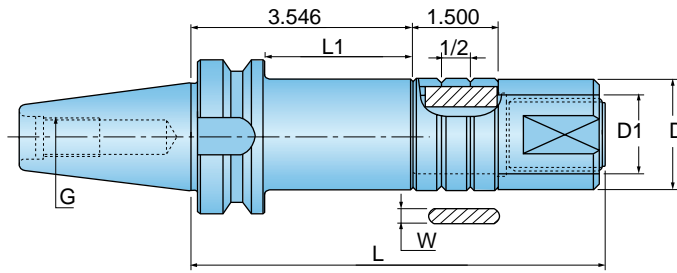

Designation	D1	L1	L	D	W	G
BT40 STUB 1X3.546	1.000	2.480	6.260	1.500	.250	M16
BT40 STUB 1-1/4X3.546	1.250	2.480	6.378	1.772	.312	M16
BT50 STUB 1X3.546	1.000	2.055	6.268	1.500	.250	M24
BT50 STUB 1-1/4X3.546	1.250	2.055	6.386	1.772	.312	M24

BT - DRILL CHUCK ARBOR

Taper Size
BT-30, 40 and 50

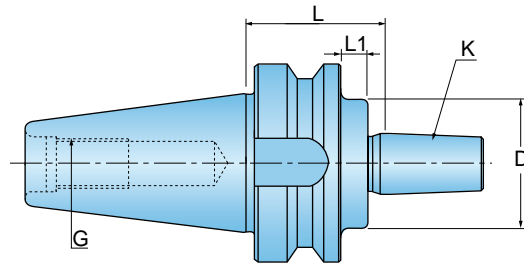
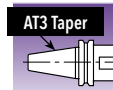
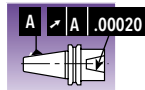

Designation	K	L	L1	D	G
BT30 DC J2X1.187	J2	1.187	.215	1.181	M12
BT30 DC J3X1.187	J3	1.187	-	-	M12
BT30 DC J6X1.187	J6	1.187	-	-	M12
BT40 DC J2X1.750	J2	1.750	.589	1.181	M16
BT40 DC J3X1.750	J3	1.750	.477	1.339	M16
BT40 DC J33X1.750	J33	1.750	.598	1.181	M16
BT40 DC J4X1.750	J4	1.750	.539	1.732	M16
BT40 DC J6X1.750	J6	1.750	.589	1.181	M16
BT50 DC J2X1.750	J2	1.750	-	-	M24
BT50 DC J3X1.750	J3	1.750	.157	1.339	M24
BT50 DC J33X1.750	J33	1.750	-	-	M24
BT50 DC J4X1.750	J4	1.750	.157	1.339	M24
BT50 DC J5X1.750	J5	1.750	-	-	M24
BT50 DC J6X1.750	J6	1.750	1.54	1.339	M24

BT - MORSE TAPER ADAPTER - METRIC

Taper Size
BT-30, 40 and 50

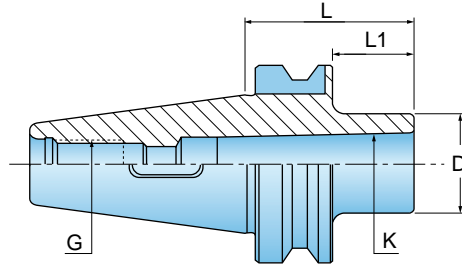

Designation	K	L	L1	D	G
BT30 MT1X 45	MT1	45	23	25	M12
BT30 MT2X 60	MT2	60	38	32	M12
BT40 MT1X 45	MT1	45	18	25	M16
BT40 MT1X120	MT1	120	93	25	M16
BT40 MT2X 60	MT2	60	33	32	M16
BT40 MT2X120	MT2	120	93	32	M16
BT40 MT3X 75	MT3	75	48	40	M16
BT40 MT3X139	MT3	139	112	40	M16
BT40 MT4X 95	MT4	95	68	50	M16
BT50 MT1X 45	MT1	45	7	25	M24
BT50 MT1X120	MT1	120	82	25	M24
BT50 MT1X180	MT1	180	142	25	M24
BT50 MT2X 45	MT2	45	7	32	M24
BT50 MT2X135	MT2	135	97	32	M24
BT50 MT2X180	MT2	180	142	32	M24
BT50 MT3X 45	MT3	45	7	40	M24
BT50 MT3X150	MT3	150	112	40	M24
BT50 MT3X180	MT3	180	142	40	M24
BT50 MT4X 75	MT4	75	37	50	M24
BT50 MT4X180	MT4	180	142	50	M24
BT50 MT5X105	MT5	105	67	70	M24

BT - CENTER ALIGNMENT COLLET CHUCK - METRIC

Taper Size
BT-40 and 50

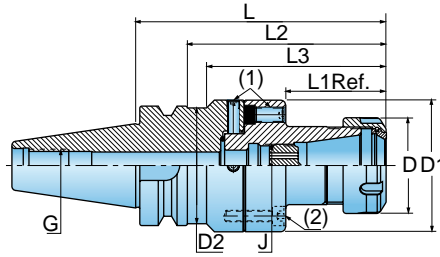
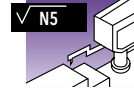
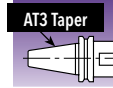

Designation	Range	L	L1	L2	L3	D	D1	D2	J	G	Hex Key(1)	Hex Key(2)
ADJ BT40 D70 ER32	2-20	129.5	52.5	102.5	92.5	50	70	62.5	M22x1.5	M16	4.0	5.0
ADJ BT50 D70 ER32	2-20	144.5	52.5	106.5	-	50	70	-	M22x1.5	M24	4.0	5.0

The tools should be adjusted prior to initial use



BT - CENTER ALIGNMENT SHANK AND BASE - METRIC FOR SPECIALLY TAILORED TOOL HOLDERS

Taper Size
BT-40 and 50

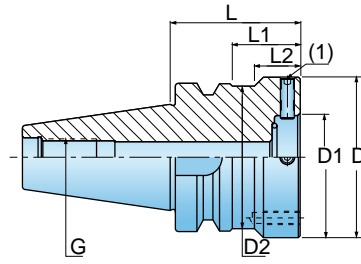
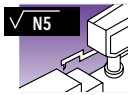
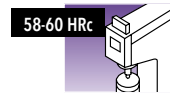
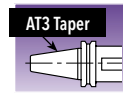

Designation	L	L1	L2	D	D1	D2	G	Hex key(1)
ADJ BT40 D70	55	28	18	70	35	62.5	M16	4
ADJ BT50 D70	70	32	-	70	35	-	M24	4



Ingersoll



SPECIAL ADAPTIONS & ACCESSORIES.

Cutting Tools



Member IMC Group
Ingersoll
Cutting Tools

SPECIAL ADAPTIONS & ACCESSORIES.

Description	Series	Page	
	ST SERIES ST - Mini ER Collet Chuck	ST_ER11-20M/MF	824
	ST SERIES ST - ER Collet Chuck	ST_ER11-20	825
	ST SERIES ST - ER Collet Chuck	ST_ER25-40F	826
	ST SERIES ST - Mini Collet Chuck with a Flat	ST_ER16-20MF	827
	ST SERIES ST - Mini Collet Chuck with a Flat - Metric	ST_ER16-25MF (METRIC)	828
	ST SERIES ST - Double Ended Mini Collet Chuck with a Flat	ST_ER11-16MF-D	829
	ST SERIES ST - Double Ended Mini Collet Chuck with a Flat - Metric	ST_ER11-20MF-D (METRIC)	830
	ST SERIES ST - ER Collet Chuck with Internal Coolant - Two Options	ST_ER16-40S	831
	ST SERIES ST - Straight Shank Shrink	ST_SRK	832
	ST SERIES ST - Straight Shank Shrink - Metric	ST_SRK (METRIC)	833
	ER SERIES GTI - Tapping Attachment	GTI-ER_ST	834
	ER SERIES MT - ER Collet Chuck	MT_ER	835

	Description	Series	Page
	ADJ SERIES ADJ - Center Alignment Collet Chuck	ADJ-ST_ER	836
	ADJ SERIES ADJ - Center Alignment Shank and Base for Specially Tailored Tool Holders	ADJ-ST_D	837
	ER SERIES ER - Collet Standard		839
	ER SERIES ER - Top Clamping Nut DIN 6499		840
	ER SERIES ER - Spring Collets DIN 6499	ER_SPR, ER_EX	841
	ER SERIES ER - Spring Collet DIN 6499 'AA'	ER_SPR-AA	842
	ER COOLIT SERIES ER Coolit - Sealed Jet Collet 1450 PSI	ER_SEAL	843
	ER COOLIT SERIES ER Coolit - Sealed Jet2 Spring Collets 1450 PSI	ER_SEAL-JET2	844
	ER SERIES ER - Spring Collet Sets DIN 6499	SET-ER_SPR, SET-ER_SPR_AA	845
	ER COOLIT SERIES ER Coolit - Sealed Jets Collet Sets 1450 PSI	SET-ER_SEAL, SET-ER_SEAL_JET2	845
	ER SERIES ER Spring EMI Collet Sets DIN 6499	SET-ER_SPR_EMI	846
	ER COOLIT SERIES ER Coolit - Sealed Jet EMI Collet Sets	SET-ER_SEAL_EMI	846

SPECIAL ADAPTIONS & ACCESSORIES.

Description	Series	Page
	SHRINK SERIES Thermal Shrink Chucking Systems	847
	SHRINK SERIES ER - Thermal Shrink ER Collet DIN 6499	ER_SRK, ER_SRK-JET2 849
	SHRINK SERIES ER - Shrink ER Collet DIN 6499 - Metric	ER_SRK, ER_SRK-JET2 (Metric) 850
	QWIK DRAW SERIES Quik Draw - Induction Heating Unit	IND SRHINKIN UNIT USA 851
	QWIK DRAW SERIES Quik Draw - Shrink Thermal Electrical Unit	IND SHRINKIN START UNIT USA 852
	DRAW-IN SERIES Draw In - Thermal Heating Unit V2 Version	SHRINKIN UNIT V2 USA 853
	DRAW-IN SERIES Thermal Shrink SRK ER 32 Collet Set	SET ER32 SHRINKIN 854
	DRAW-IN SERIES Thermal Shrink Kit	KIT SHRINKIN_V2 USA 854
	GTIN SERIES GTIN - ER Tapping Collet	GTIN-ER32-ANSI 855
	GTIN SERIES GTIN - ER Tapping Collet	GTIN-ER32-ISO, GTIN-ER32-DIN, GTIN-ER32-JIS 856
	ACCESSORIES SERIES Accessories - Pull Stud - CAT ANSI	PS-CAT_ANSI 857
	ACCESSORIES SERIES Accessories - Pull Stud - CAT MAS	PS-CAT_MAS 857

	Description	Series	Page
	ACCESSORIES SERIES Accessories - Pull Stud - OTT System - Metric	PS-OTT_M (Metric)	858
	ACCESSORIES SERIES Accessories - Pull Stud - BT-MAS - Metric	PS-BT_M_MAS (Metric)	858
	ACCESSORIES SERIES Accessories - Pull Stud - BT-JIS/ANSI - Metric	PS-BT_M_JIS/MAZAK (Metric)	859
	ACCESSORIES SERIES Accessories - Pull Stud - DIN69872/ISO 7388 - Metric	PS-SK_M_DIN/ISO (Metric)	859
	ACCESSORIES SERIES Accessories - ER Clamping Nut DIN 6499 - Metric	NUT-ER_TOP/TOP MINI (Metric)	860
	ACCESSORIES SERIES Accessories - ER -UM & MINI Clamping Nut DIN 6499 - Metric	NUT-ER_UM/MINI	860
	ACCESSORIES SERIES Accessories - NUT E32 SHORTIN - Metric	NUT-ER_SHORT	861
	ACCESSORIES SERIES Accessories - Wrench for ER DIN 6499 - Metric	WRENCH-ER/ER_MINI/ER_SHORT	862
	ACCESSORIES SERIES Accessories - Standard Preset Screw	PRESET SCREW (Inch)	863
	ACCESSORIES SERIES Accessories - Preset Screw with Coolant Holes	PRESET-ER-JET (Metric)	863
	ACCESSORIES SERIES Accessories - Lock Screw for Shell Mill Holder	SCREW_SEM	864
	ACCESSORIES SERIES Accessories - Lock Screw for Shell Mill Holder - Metric	M_CLAMP-SCREW-SEM (Metric)	864

SPECIAL ADAPTIONS & ACCESSORIES.

Description	Series	Page	
	ACCESSORIES SERIES Accessories - Lock Screw for End Mill Holder	SCREW_EM	865
	ACCESSORIES SERIES Accessories - Preset Screw for Thermal Shrink Collets - Metric	PRESET-SCREW-M_B (Metric)	866
	ACCESSORIES SERIES Accessories - HSK Cooling Tube - Metric	COOLING-TUBE-HSK -A (Metric)	867
	ACCESSORIES SERIES Accessories - Wrench for HSK Cooling Tube - Metric	WRENCH-COOL-TUBE-HSK (Metric)	867
	ACCESSORIES SERIES Accessories - Tool Clamp Fixture	TOOL-CLAMP_ROTARY/FIX	868
	ACCESSORIES SERIES Accessories - Multi Clamp HSK E/F	MULTI-CLAMP_A/C	868
	ACCESSORIES SERIES Accessories - Multi Clamp HSK A/C	MULTI-CLAMP_E/F	869
	ACCESSORIES SERIES Accessories - Easylock - Electrical Nut-Clamp Torque Control Device	EASYLOCK TC USA, EASYLOCK TROLLEY	870

ST - MINI ER COLLET CHUCK

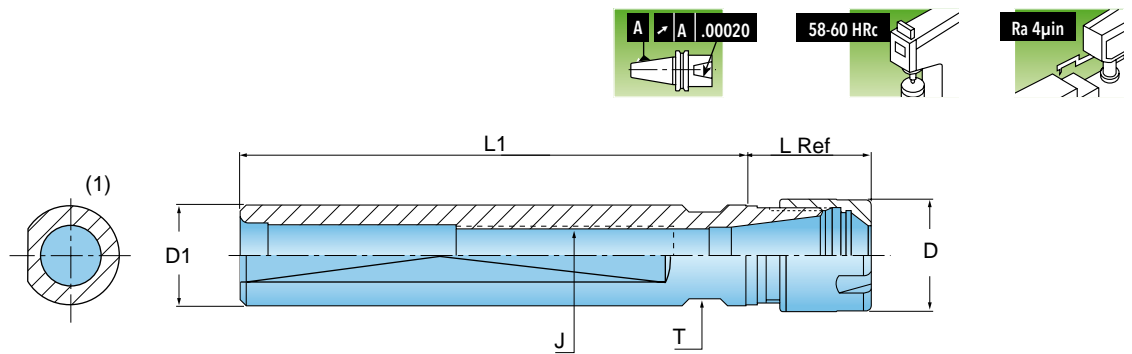

Designation	Range	L1	L	J	D1	D	T**
ST1/2X4.000 ER11 M	.022-.278	4.000	.734	-	.500	.630	.433
ST5/8X2.500 ER11MF*	.022-.278	2.500	.734	M8	.625	.630	.512
ST5/8X4.000 ER11 M	.022-.278	4.000	.734	M8	.625	.630	.512
ST5/8X6.000 ER11 M	.022-.278	6.000	.734	M8	.625	.630	.512
ST1/2X4.000 ER16 M	.022-.396	4.000	1.480	-	.500	.866	.433
ST3/4X2.500 ER16MF*	.022-.396	2.500	1.000	M12	.750	.866	.630
ST3/4X4.000 ER16MF*	.022-.396	4.000	1.000	M12	.750	.866	.630
ST3/4X6.000 ER16 M	.022-.396	6.000	1.000	M12	.750	.866	.630
ST5/8X1.250 ER16 M	.022-.396	1.250	1.378	M10	.625	.866	.669
ST3/4X2.500 ER20MF*	.041-.514	2.500	1.562	M12	.750	1.102	.827
ST3/4X4.000 ER20 M	.041-.514	4.000	1.562	M12	.750	1.102	.827
ST3/4X6.000 ER20 M	.041-.514	6.000	1.562	M12	.750	1.102	.827

* With a flat
 ** Wrench size

ST - ER COLLET CHUCK

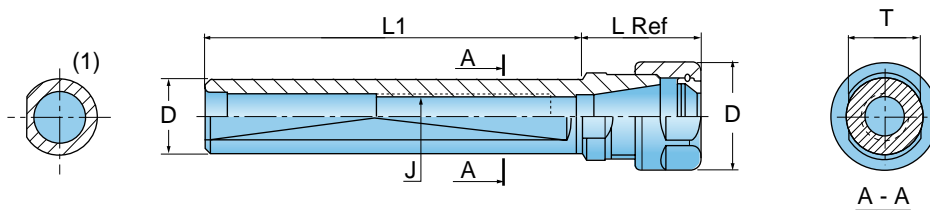
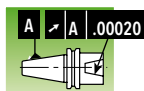

Designation	Range	L1	L	J	D1	D	T **
ST5/8X2.50 ER11F*	.022-.278	2.500	.734	M8	.625	.748	.512
ST3/4X2.50 ER11F*	.022-.278	2.500	.734	M10	.750	.748	.669
ST3/4X4.00 ER11	.022-.278	4.000	.734	M10	.750	.748	.669
ST3/4X6.00 ER11	.022-.278	6.000	.734	M10	.750	.748	.669
ST3/4X2.50 ER16F*	.022-.396	2.500	1.187	M12	.750	1.102	.748
ST3/4X4.00 ER16	.022-.396	4.000	1.187	M12	.750	1.102	.748
ST3/4X6.00 ER16	.022-.396	6.000	1.187	M12	.750	1.102	.748
ST3/4X2.50 ER20F*	.041-.514	2.500	1.656	M12	.750	1.339	.866
ST3/4X4.00 ER20	.041-.514	4.000	1.656	M12	.750	1.339	.866
ST3/4X6.00 ER20	.041-.514	6.000	1.656	M12	.750	1.339	.866

* With a flat

** Wrench size

ST - ER COLLET CHUCK

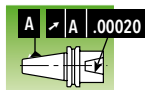
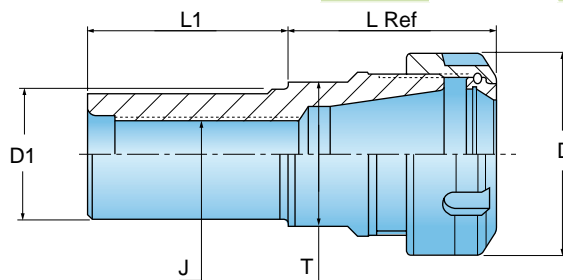
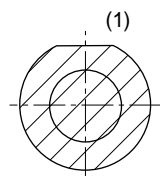

58-60 HRc



Designation	Range	L1	L	J	D1	D	T**
ST3/4X2.00 ER25F*	.041-.632	2.000	1.732	M12	.750	1.654	1.102
ST3/4X4.00 ER25	.041-.632	4.000	1.772	M12	.750	1.654	1.102
ST3/4X2.00 ER32F*	.080-.789	2.000	2.126	M12	.750	1.968	1.417
ST1X2.00 ER32F*	.080-.789	2.000	2.087	M16	1.000	1.968	1.417
ST1-1/4X2.375 ER32F*	.080-.789	2.375	2.087	M18	1.250	1.968	1.417
ST1-1/4X6.00 ER32	.080-.789	6.000	2.047	M18	1.250	1.968	1.417
ST1X2.37 ER40F*	.120-1.025	2.370	2.362	M16	1.000	2.480	1.772
ST1-1/4X2.37 ER40	.120-1.025	2.370	2.362	M18	1.250	2.480	1.772

* With a flat

** Wrench size

ST - MINI COLLET CHUCK WITH A FLAT

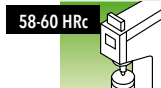
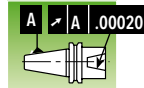
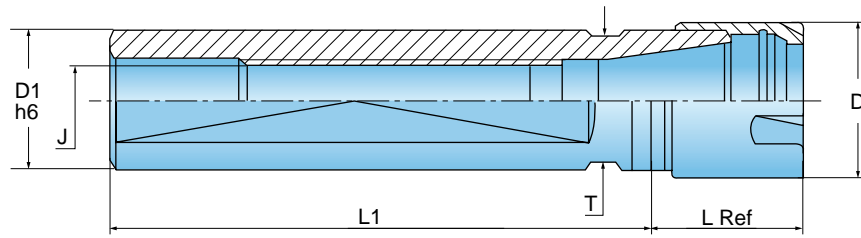
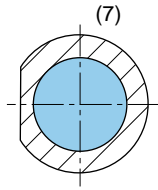

Designation	Range	L1	L	J	D1	D	T*	Machine Type
ST3/4 X1.496 ER16 MF	.022-.396	1.496	1.024	M12X1	.750	.866	.669	**
ST3/4 X1.969 ER16 MF	.022-.396	1.969	1.024	M12X1	.750	.866	.669	**
ST3/4 X2.756 ER16 MF	.022-.396	2.756	1.024	M12X1	.750	.866	.669	**
ST3/4 X4.724 ER16 MF	.022-.396	4.724	1.024	M12X1	.750	.866	.669	**
ST3/4 X5.512 ER16 MF	.022-.396	5.512	1.024	M12X1	.750	.866	.669	**
ST1 X2.559 ER16 MF	.022-.396	2.559	1.102	M12X1	1.000	.866	.866	***
ST1 X2.953 ER16 MF	.022-.396	2.953	1.102	M12X1	1.000	.866	.866	**
ST1 X3.937 ER16 MF	.022-.396	3.937	1.102	M12X1	1.000	.866	.866	**
ST1 X3.937 ER20 MF	.041-.514	3.937	1.102	M14X1	1.000	1.102	.866	**
ST1 X5.512 ER20 MF	.041-.514	5.512	1.102	M14X1	1.000	1.102	.866	**

* Wrench size

** Citizen

*** Manurhin

ST - MINI COLLET CHUCK WITH A FLAT - METRIC

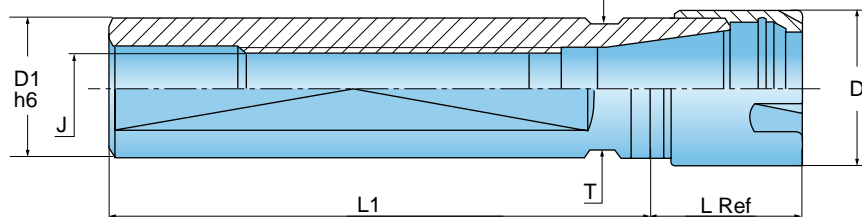
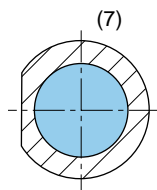

Designation	Range	L1	L	J	D	D1	T(6)	Machine Type
ST 16X 35 ER16 MF	0.5-7	35.00	36.00	M8X1	22.0	16.00	17	(4)
ST 16X 38 ER11 MF	0.5-7	38.00	18.50	M8X1	16.0	16.00	14	
ST 16X140 ER11 MF	0.5-7	140.00	18.50	M8X1	16.0	16.00	14	
ST 20X 50 ER16 MF	0.5-10	50.00	26.00	M12X1	22.0	20.00	17	(1)
ST 20X 70 ER16 MF	0.5-10	70.00	26.00	M12X1	22.0	20.00	17	(1)
ST 20X120 ER16 MF	0.5-10	120.00	26.00	M12X1	22.0	20.00	17	(1)
ST 20X140 ER16 MF	0.5-10	140.00	26.00	M12X1	22.0	20.00	17	(1)
ST 22X 38 ER16 MF	0.5-10	38.00	26.00	M12X1	22.0	22.00	19	(4)
ST 22X 70 ER16 MF	0.5-10	70.00	26.00	M12X1	22.0	22.00	19	(4)
ST 22X 70 ER25 MF	0.5-10	70.00	47.00	M12X1	35.0	22.00	27	(4)
ST 22X 80 ER20 MF	1-13	80.00	39.00	M12X1	28.0	22.00	21	(4)
ST 22X100 ER16 MF	1-16	100.00	28.00	M12X1	22.0	22.00	19	(4)
ST 25X 65 ER16 MF	0.5-10	65.00	28.00	M12X1	22.0	25.00	22	
ST 25X 75 ER25 MF	1-13	75.00	48.00	M14X1	35.0	25.00	27	(5)
ST 25X100 ER20 MF	1-13	100.00	28.00	M14X1	28.0	25.00	22	(5)
ST 25X145 ER25 MF	1-16	145.00	36.00	M14X1	35.0	25.00	27	(2)
ST 25X154 ER20 MF	1-16	154.00	28.00	M14X1	28.0	25.00	22	(5)
ST 32X 70 ER25 MF	1-16	70.00	30.00	M18X1	35.0	32.00	27	(3)

- (1) Citizen
- (2) Manurhin
- (3) Schutte
- (4) Star
- (5) Tornos-Bechler
- (6) Wrench size
- (7) With a flat

ST - DOUBLE ENDED MINI COLLET CHUCK WITH A FLAT

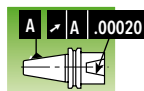

58-60 HRC



Ra 4μin

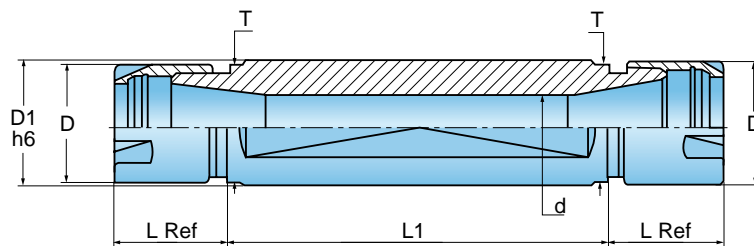

Designation	Range	L1	L	D1	D	d	T*	Machine Type
ST3/4X2.756 ER11 MF D	.022-.278	2.756	.787	.750	.630	.295	.669	**
ST3/4X2.165 ER16 MF D	.022-.396	2.165	1.024	.750	.866	.413	.669	**
ST1 X2.441 ER16 MF D	.022-.396	2.441	1.102	1.000	.866	.413	.866	***

* Wrench size
 ** Citizen
 *** Manurhin

ST - DOUBLE ENDED MINI COLLET CHUCK WITH A FLAT - METRIC

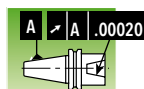

58-60 HRC



Ra 4µm

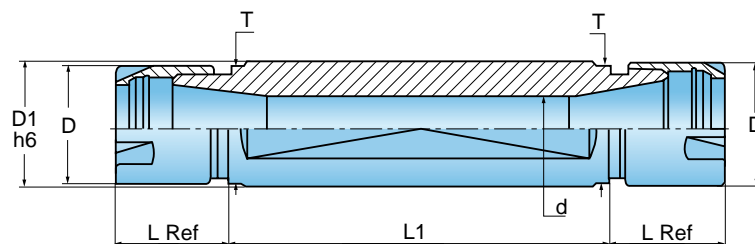

Designation	Range	D	D1 h6	d	L1	L	T *	Machine Type
ST 16X 50 ER11 MF D	0.5-7	16	16	7.5	50	18.5	14	
ST 20X 30 ER11 MF D	0.5-7	16	20	7.5	30	18.5	17	**
ST 20X 50 ER11 MF D	0.5-7	16	20	7.5	50	18.5	17	**
ST 20X 55 ER16 MF D	0.5-10	22	20	10.5	55	25.0	17	**
ST 22X 55 ER16 MF D	0.5-10	22	22	10.5	55	28.0	19	***
ST 22X 75 ER16 MF D	0.5-10	22	22	10.5	75	28.0	19	***
ST 25X 62 ER16 MF D	0.5-10	22	25	10.5	62	28.0	22	
ST 32X 55 ER20 MF D	1-13	28	32	13.5	55	28.0	27	***
ST 32X 75 ER20 MF D	1-13	28	32	13.5	75	28.0	27	***

* Wrench size

** Citizen

*** Star

ST - ER COLLET CHUCK WITH INTERNAL COOLANT - TWO OPTIONS

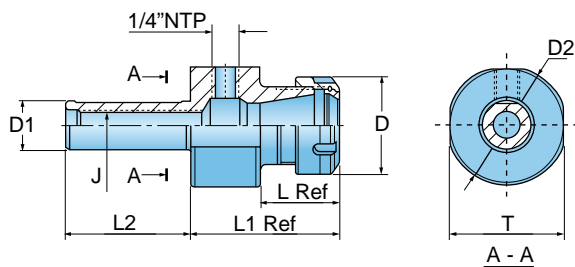
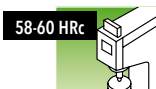
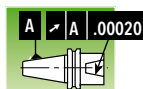

Designation	Range	L2	L1	L	J	D1	D	D2	T
ST3/4X3.000 ER16S	.022-.396	3.000	2.150	1.165	M12	.750	1.102	1.575	1.339
ST3/4X3.000 ER20S	.041-.514	3.000	2.500	1.240	M12	.750	1.339	1.535	1.339
ST3/4X3.000 ER25S	.041-.632	3.000	2.680	1.220	M12	.750	1.654	2.126	1.890
ST1X3.000 ER32S	.080-.789	3.000	3.000	1.614	M16	1.000	1.968	2.480	2.323
ST1-1/4X3.000 ER40S	.120-1.025	3.000	3.030	1.642	M18X1.5	1.250	2.480	2.992	2.835

ST - STRAIGHT SHANK SHRINK

G2.5
20,000 RPM

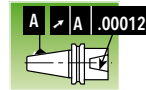

58-60 HRC

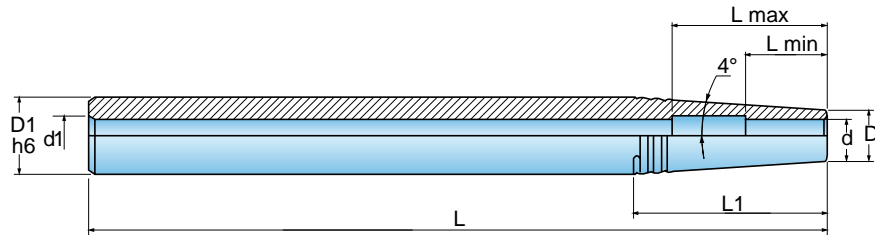
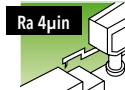

Designation	d	D	D1	d1	L	L1	Lmin	Lmax
ST 1/2X6.30 SRK 1/8	.125	.394	.500	.157	6.300	.760	.394	-
ST 1/2X6.30 SRK 3/16	.188	.394	.500	.157	6.300	.760	.591	1.181
ST 5/8X6.30 SRK 1/8	.125	.394	.625	.236	6.300	1.374	.394	-
ST 5/8X6.30 SRK 3/16	.188	.394	.625	.236	6.300	1.654	.591	-
ST 5/8X6.30 SRK 1/4	.250	.433	.625	.236	6.300	1.374	.709	1.378
ST 3/4X8.00 SRK 3/16	.188	.394	.750	.236	8.000	2.548	.591	-
ST 3/4X8.00 SRK 1/4	.250	.433	.750	.236	8.000	2.267	.709	1.378
ST 3/4X8.00 SRK 5/16	.313	.551	.750	.236	8.000	1.422	.984	1.575
ST 1X8.000 SRK 1/4	.250	.433	1.000	.315	8.000	4.053	.709	1.378
ST 1X8.000 SRK 5/16	.313	.551	1.000	.315	8.000	3.209	.984	1.575
ST 1X8.000 SRK 3/8	.375	.630	1.000	.315	8.000	2.646	1.181	1.772
ST 1X8.000 SRK 1/2	.500	.787	1.000	.315	8.000	1.520	1.260	1.969

ST - STRAIGHT SHANK SHRINK - METRIC

G2.5
20,000 RPM

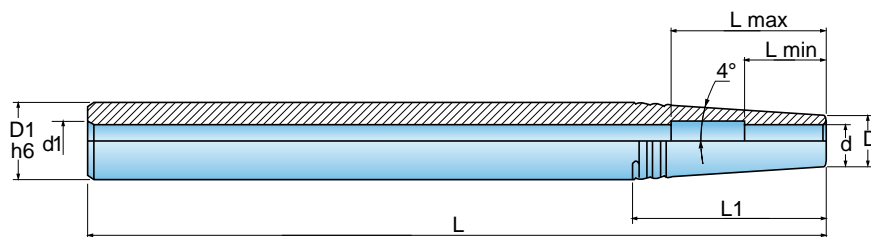
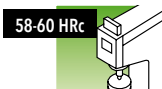
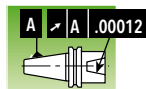

Designation	d	D	D1	d1	L	L1 Ref.	Lmin	Lmax
ST 12x160 SRK 3	3	10	12	4	160	14	10	-
ST 12x160 SRK 4	4	10	12	4	160	14	12	27
ST 16x160 SRK 3	3	10	16	6	160	43	10	-
ST 16x160 SRK 4	4	10	16	6	160	43	12	-
ST 16x160 SRK 5	5	10	16	6	160	43	15	-
ST 16x160 SRK 6	6	11	16	6	160	35	18	35
ST 20x200 SRK 5	5	10	20	6	200	71	15	-
ST 20x200 SRK 6	6	11	20	6	200	64	18	40
ST 20x200 SRK 8	8	14	20	6	200	43	25	40
ST 25x200 SRK 6	6	11	25	8	200	100	18	35
ST 25x200 SRK 8	8	14	25	8	200	79	25	40
ST 25x200 SRK 10	10	16	25	8	200	64	30	50
ST 25x200 SRK 12	12	20	25	8	200	36	32	52



GTI - TAPPING ATTACHMENT

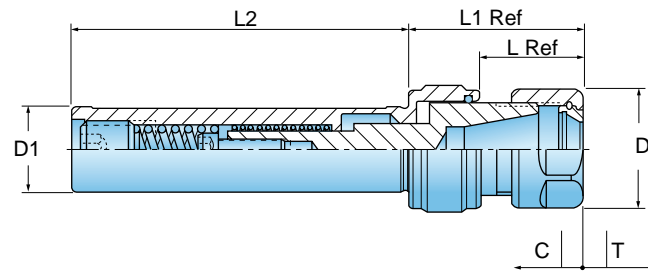

58-60 HRc

Ra 4 μ m

Designation	Tap Capacity	Range	D1	L2	L1	L	D	T	C
GTI ER11 ST5/8	#3-1/4"	.022-.278	.625	6.00	-	.75	.63	.24	.12
GTI ER16 ST3/4	#6-3/8"	.022-.396	.750	3.15	1.61	.95	1.10	.32	.12
GTI ER20 ST3/4	#8-1/2"	.041-.514	.750	3.15	1.89	1.06	1.34	.32	.12
GTI ER25 ST1	#10-5/8"	.041-.632	1.000	3.15	2.01	1.18	1.66	.36	.16
GTI ER32 ST1	1/4-3/4"	.080-.789	1.000	3.15	2.91	1.18	1.97	.36	.16
GTI ER40 ST1-1/4	5/16-1-3/8"	.120-1.025	1.250	3.15	3.54	1.81	2.36	.36	.16

MT - ER COLLET CHUCK

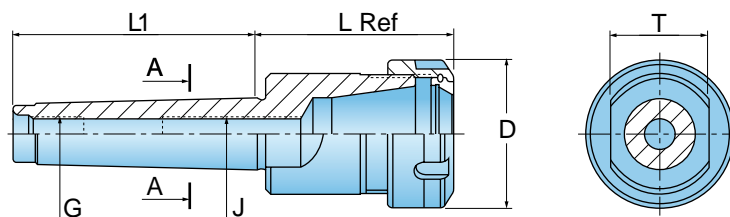
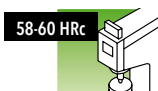
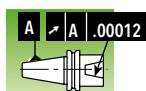

Designation	Range	L	L1	D	J	G	T
MT2 ER20x1.909	.022-.514	1.909	2.520	1.339	M10	3/8-16	.866
MT2 ER25x2.008	.041-.632	2.008	2.520	1.654	M10	3/8-16	1.102
MT3 ER32x2.717	.080-.789	2.717	3.189	1.968	M12	1/2-13	.945
MT3 ER40x3.150	.120-1.025	3.150	3.189	2.480	M12	1/2-13	.945
MT4 ER32x2.382	.080-.789	2.382	4.035	1.968	M16	5/8-11	1.260
MT4 ER40x3.193	.120-1.025	3.193	4.035	2.480	M16	5/8-11	1.260
MT4 ER50x4.232	.396-1.338	4.232	4.035	3.070	M16	5/8-11	1.260
MT5 ER40x3.445	.102-1.025	3.445	5.098	2.480	M28x1.5	3/4-10	1.772
MT5 ER50x3.346	.396-1.338	3.346	5.098	3.070	M28x1.5	3/4-10	1.772
MT6 ER50x3.465	.396-1.338	3.465	7.165	3.070	M36x1.5	1 - 8	2.362



ADJ - CENTER ALIGNMENT COLLET CHUCK

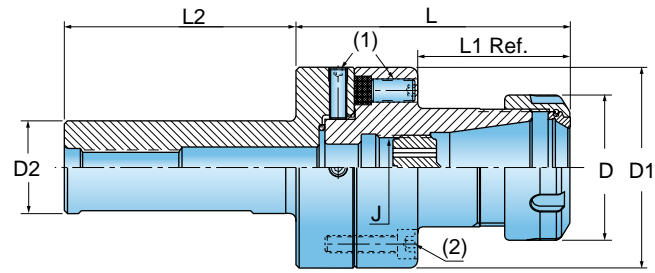

58-60 HRc

√ N5

Designation	Range	L	L1	L2	D	D1	D2	J	Hex Key(1) (mm)	Hex Key(1) (mm)
ADJ ST1 ER32	.080-.789	3.720	2.067	3.150	1.969	2.756	1.000	M22x1.5	4.0	5.0
ADJ ST1-1/4 ER32	.080-.789	3.720	2.067	3.150	1.969	2.756	1.250	M22x1.5	4.0	5.0

Note: The tools should be adjusted prior to initial use.

■ ADJ - CENTER ALIGNMENT SHANK AND BASE FOR SPECIALLY TAILORED TOOL HOLDERS

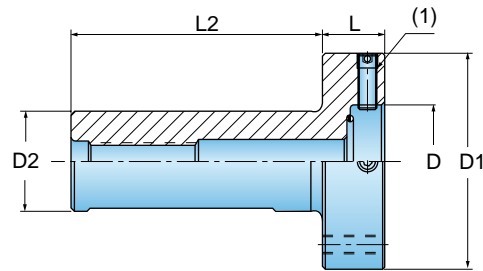
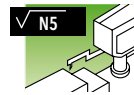
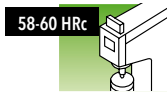

Designation	L	L2	D	D1	D2	Hex key(1) (mm)
ADJ ST1 D2.756	.787	3.15	2.756	1.378	1.000	4
ADJ ST1-1/4 D2.756	.787	3.15	2.756	1.378	1.250	4

ER COLLET CHUCKING SYSTEM

SHANKS

CAT A.N.S.I B5.50/DIN 69871



HSK DIN 69893 FORM A/E



BT MAS-403



ISO A.N.S.I B5.18-DIN 2080



R-8 BRIDGEPORT



ST STRAIGHT SHANK



MT MORSE TAPER



COLLETS

ER-SPR



ER-SEAL



ER-SEAL JET2



ER-SRK



ER32 GTIN



ER32 ODP



ER COLLET STANDARD

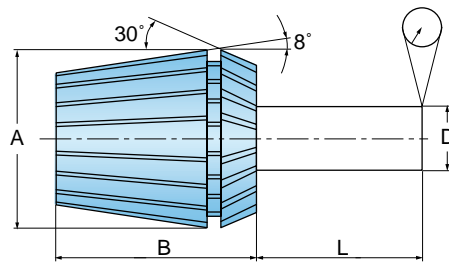

DIN 6499 RUNOUT PRECISION

L Inch	L mm	D Inch	D mm	ICTC Precision Standard -Inch	ICTC "AA" mm	Ultra Precision Inch	mm	DIN 6499 ⁽¹⁾ Inch	mm
.24	6	.039-.063	1.0- 1.6	.0004	0.01	.0002	0.005		
.39	10	.063-.118	1.6- 3.0	.0004	0.01	.0002	0.005	.0006	0.015
.63	16	.118-.236	3.0- 6.0	.0004	0.01	.0002	0.005	.0006	0.015
.98	25	.236-.394	6.0-10.0	.0004	0.01	.0002	0.005	.0006	0.015
1.57	40	.394-.709	10.0-18.0	.0004	0.01	.0002	0.005	.0008	0.020
1.97	50	.709-1.024	18.0-26.0	.0004	0.01	.0002	0.005	.0008	0.020
2.36	60	1.024-1.339	26.0-34.0					.0010	0.025

⁽¹⁾ ER50 DIN6499

ER SIZES

Type	A Inch	A mm	B Inch	B mm
ER-11	.45	11.5	.71	18
ER-16	.67	17	1.06	27
ER-20	.83	21	1.22	31
ER-25	1.02	26	1.38	35
ER-32	1.30	33	1.57	40
ER-40	1.61	41	1.81	46
ER-50	2.05	52	2.36	60

ER - Sealed Collet - Two Types:



Sealed Collet Jet
For straight shank cutting tools with internal coolant supply.



Sealed Collet Jet2
With angular double nozzles. Coolant flow is direct to the cutting edge, for use with standard straight shank cutting tools (without coolant hole).

Standard shanks which can be used in sealed collets

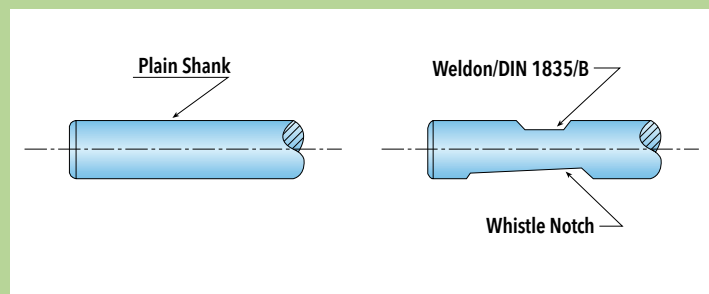

Note: The front end of the sealed collet should be located beyond Weldon or the whistle notch.

ER - TOP CLAMPING NUT DIN 6499

Description:

Friction bearing ER nut has a unique two-piece exclusive friction mechanism combining radial and angular self-centering movements.

Features:

- Unique two-piece friction bearing.
- Radial and angular float for better concentricity.
- Powerful gripping force, 50-100% higher than the standard ER nut due to the friction bearing mechanism.
- Balanced for higher spindle spin due to unique extractor teeth design.
- Compact design - general dimensions and size range are the same as the standard nut.
- Designed for use with sealed collets.

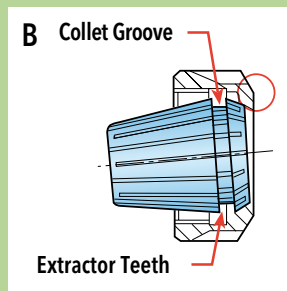
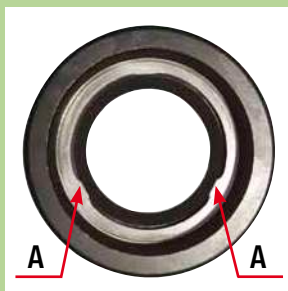

Important: Never insert the collet parallel to the extractor ring. Doing this will chip or break the extractor's teeth. When unclamping the nut, the collet will self-release from the chuck by means of extractor teeth.

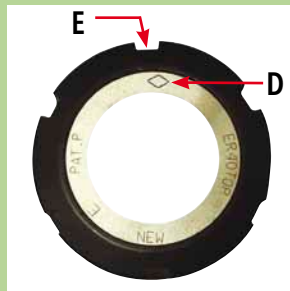

Always assemble the collet into the nut before mounting onto the collet chuck.

Insertion Procedure:

1. Insert the collet at an angle, fitting the two extractor teeth which protrude (A) into the collet's groove (B).
2. Place the two parts on a clean and horizontal work surface.
3. Press down with your thumb on the back end of the collet until it clicks into place (C).

Extracting Procedure

1. Align the engraved diamond shape which is on the silver ring (D), with any of the key slots (E) of the nut.
2. Place the nut with the collet facing down on a clean and horizontal work surface.
3. Insert a screwdriver vertically between the nut slots and the collet on the reverse side of the engraved diamond shape (D).
4. Tilt the screwdriver outwards, while helping the extraction by pushing the collet's back end in the opposite direction (F).

Note: For maximum performance the clamping nut thread and collet taper must be cleaned and oiled before use.

Nut type	LbsxFt	KgxM
E-11	36	5
ER-11M	21	3
ER-16	50	7
ER-16M	29	4
ER-20	86	12
ER-20M	58	8
ER-25	144	20
ER-32	160	22
ER-40	180	25
ER-50	252	35

Recommended Clamping Torque for Standard ER & ER-Top Clamping Nut

Important:

This torque is calculated with the maximum diameter capacity per collet, which should be gradually reduced when used with a smaller shank size.

46-48 HRC



Ra 4µm

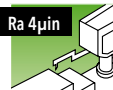

ER-11, 16, 20, 25.32-SPR

Designation	Diameter Range	Diameter Range (mm)
ER11 SPR .022-.041	1/32 (.022-.041)	0.5- 1
ER11 SPR .041-.080	1/16 (.041-.080)	1.0- 2
ER11 SPR .080-.120	3/32 (.080-.120)	2.0- 3
ER11 SPR .120-.159	1/8 (.120-.159)	3.0- 4
ER11 SPR .159-.199	3/16 (.159-.199)	4.0- 5
ER11 SPR .199-.238	7/32 (.199-.238)	5.0- 6
ER11 SPR .238-.278	1/4 (.238-.278)	6.0- 7
ER16 SPR .022-.041	1/32 (.022-.041)	0.5- 1
ER16 SPR .041-.080	1/16 (.041-.080)	1.0- 2
ER16 SPR .080-.120	3/32 (.080-.120)	2.0- 3
ER16 SPR .120-.159	1/8 (.120-.159)	3.0- 4
ER16 SPR .159-.199	3/16 (.159-.199)	4.0- 5
ER16 SPR .199-.238	7/32 (.199-.238)	5.0- 6
ER16 SPR .238-.278	1/4 (.238-.278)	6.0- 7
ER16 SPR .278-.317	5/16 (.278-.317)	7.0- 8
ER16 SPR .317-.356	11/32 (.317-.356)	8.0- 9
ER16 SPR .356-.396	3/8 (.356-.396)	9.0-10
ER20 SPR .041-.080	1/16 (.041-.080)	1.0- 2
ER20 SPR .080-.120	3/32 (.080-.120)	2.0- 3
ER20 SPR .120-.159	1/8 (.120-.159)	3.0- 4
ER20 SPR .159-.199	3/16 (.159-.199)	4.0- 5
ER20 SPR .199-.238	7/32 (.199-.238)	5.0- 6
ER20 SPR .238-.278	1/4 (.238-.278)	6.0- 7
ER20 SPR .278-.317	5/16 (.278-.317)	7.0- 8
ER20 SPR .317-.356	11/32 (.317-.356)	8.0- 9
ER20 SPR .356-.396	3/8 (.356-.396)	9.0-10
ER20 SPR .396-.435	13/32 (.396-.435)	10.0-11
ER20 SPR .435-.474	7/16 (.435-.474)	11.0-12
ER20 SPR .474-.514	1/2 (.474-.514)	12.0-13
ER25 SPR .041-.080	1/16 (.041-.080)	1.0- 2
ER25 SPR .080-.120	3/32 (.080-.120)	2.0- 3
ER25 SPR .120-.159	1/8 (.120-.159)	3.0- 4
ER25 SPR .159-.199	3/16 (.159-.199)	4.0- 5
ER25 SPR .199-.238	7/32 (.199-.238)	5.0- 6
ER25 SPR .238-.278	1/4 (.238-.278)	6.0- 7
ER25 SPR .278-.317	5/16 (.278-.317)	7.0- 8
ER25 SPR .317-.356	11/32 (.317-.356)	8.0- 9
ER25 SPR .356-.396	3/8 (.356-.396)	9.0-10
ER25 SPR .396-.435	13/32 (.396-.435)	10.0-11
ER25 SPR .435-.474	7/16 (.435-.474)	11.0-12
ER25 SPR .474-.514	1/2 (.474-.514)	12.0-13
ER25 SPR .514-.553	17/32 (.514-.553)	13.0-14
ER25 SPR .553-.593	9/16 (.553-.593)	14.0-15
ER25 SPR .593-.632	5/8 (.593-.632)	15.0-16
ER32 SPR .080-.120	3/32 (.080-.120)	2- 3
ER32 SPR .120-.159	1/8 (.120-.159)	3- 4
ER32 SPR .159-.199	3/16 (.159-.199)	4- 5
ER32 SPR .199-.238	7/32 (.199-.238)	5- 6
ER32 SPR .238-.278	1/4 (.238-.278)	6- 7
ER32 SPR .278-.317	5/16 (.278-.317)	7- 8
ER32 SPR .317-.356	11/32 (.317-.356)	8- 9
ER32 SPR .356-.396	3/8 (.356-.396)	9-10
ER32 SPR .396-.435	13/32 (.396-.435)	10-11
ER32 SPR .435-.474	7/16 (.435-.474)	11-12
ER32 SPR .474-.514	1/2 (.474-.514)	12-13
ER32 SPR .514-.553	17/32 (.514-.553)	13-14
ER32 SPR .553-.593	9/16 (.553-.593)	14-15
ER32 SPR .593-.632	5/8 (.593-.632)	15-16
ER32 SPR .632-.671	21/32 (.632-.671)	16-17
ER32 SPR .671-.711	11/16 (.671-.711)	17-18
ER32 SPR .711-.750	3/4 (.711-.750)	18-19
ER32 SPR .750-.789	25/32 (.750-.789)	19-20

ER40, 50-SPR

Designation	Diameter Range	Diameter Range (mm)
ER40 SPR .120-.159	1/8 (.120-.159)	3- 4
ER40 SPR .159-.199	3/16 (.159-.199)	4- 5
ER40 SPR .199-.238	7/32 (.199-.238)	5- 6
ER40 SPR .238-.278	1/4 (.238-.278)	6- 7
ER40 SPR .278-.317	5/16 (.278-.317)	7- 8
ER40 SPR .317-.356	11/32 (.317-.356)	8- 9
ER40 SPR .356-.396	3/8 (.356-.396)	9-10
ER40 SPR .396-.435	13/32 (.396-.435)	10-11
ER40 SPR .435-.474	7/16 (.435-.474)	11-12
ER40 SPR .474-.514	1/2 (.474-.514)	12-13
ER40 SPR .514-.553	17/32 (.514-.553)	13-14
ER40 SPR .553-.593	9/16 (.553-.593)	14-15
ER40 SPR .593-.632	5/8 (.593-.632)	15-16
ER40 SPR .632-.671	21/32 (.632-.671)	16-17
ER40 SPR .671-.711	11/16 (.671-.711)	17-18
ER40 SPR .711-.750	3/4 (.711-.750)	18-19
ER40 SPR .750-.789	25/32 (.750-.789)	19-20
ER40 SPR .789-.829	13/16 (.789-.829)	20-21
ER40 SPR .829-.868	27/32 (.829-.868)	21-22
ER40 SPR .868-.907	7/8 (.868-.907)	22-23
ER40 SPR .907-.947	15/16 (.907-.947)	23-24
ER40 SPR .947-.986	31/32 (.947-.986)	24-25
ER40 SPR .986-1.025	1 (.986-1.025)	25-26
ER50 SPR .396-.474	13/32, 7/16 (.396-.474)	10-12
ER50 SPR .474-.553	1/2, 17/32 (.474-.553)	12-14
ER50 SPR .553-.632	9/16, 5/8 (.553-.632)	14-16
ER50 SPR .632-.711	21/32, 11/16 (.632-.711)	16-18
ER50 SPR .711-.789	3/4, 25/32 (.711-.789)	18-20
ER50 SPR .789-.868	13/16, 27/32 (.789-.868)	20-22
ER50 SPR .868-.947	7/8, 15/16 (.868-.947)	22-24
ER50 SPR .947-1.025	31/32, 1 (.947-1.025)	24-26
ER50 SPR 1.025-1.102	1-1/16 (1.025-1.102)	26-28
ER50 SPR 1.102-1.181	1-1/8 (1.102-1.181)	28-30
ER50 SPR 1.181-1.260	1-1/4 (1.181-1.260)	30-32
ER50 SPR 1.260-1.338	1-5/16 (1.260-1.338)	32-34

ER-EX* (single diameter spring collets)

Designation	Diameter	Diameter (mm)
ER32 EX .125	.125 (1/8)	3.175
ER32 EX .250	.250 (1/4)	6.350
ER32 EX .312	.312 (5/16)	7.924
ER32 EX .375	.375 (3/8)	9.525
ER32 EX .500	.500 (1/2)	12.700
ER32 EX .625	.625 (5/8)	15.875
ER32 EX .750	.750 (3/4)	19.050
ER40 EX .250	.250 (1/4)	6.350
ER40 EX .312	.312 (5/16)	7.924
ER40 EX .375	.375 (3/8)	9.525
ER40 EX .500	.500 (1/2)	12.700
ER40 EX .625	.625 (5/8)	15.875
ER40 EX .750	.750 (3/4)	19.050
ER40 EX .875	.875 (7/8)	22.225
ER40 EX 1.000	1.000	25.400

* Recommended for improved runout and clamping torque.

ER - SPRING COLLET DIN 6499 'AA'



Ultra Precision 'AA'



46-48 HRC



Ra 4µm

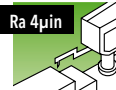

ER11, 16, 20, 25-SPR-AA

Designation	Diameter Range	Diameter Range (mm)
ER11 SPR .022-.041 AA	1/32 (.022-.041)	0.5- 1
ER11 SPR .041-.080 AA	1/16 (.041-.080)	1.0- 2
ER11 SPR .080-.120 AA	3/32 (.080-.120)	2.0- 3
ER11 SPR .120-.159 AA	1/8 (.120-.159)	3.0- 4
ER11 SPR .159-.199 AA	3/16 (.159-.199)	4.0- 5
ER11 SPR .199-.238 AA	7/32 (.199-.238)	5.0- 6
ER11 SPR .238-.278 AA	1/4 (.238-.278)	6.0- 7
ER16 SPR .022-.041 AA	1/32 (.022-.041)	0.5- 1
ER16 SPR .041-.080 AA	1/16 (.041-.080)	1.0- 2
ER16 SPR .080-.120 AA	3/32 (.080-.120)	2.0- 3
ER16 SPR .120-.159 AA	1/8 (.120-.159)	3.0- 4
ER16 SPR .159-.199 AA	3/16 (.159-.199)	4.0- 5
ER16 SPR .199-.238 AA	7/32 (.199-.238)	5.0- 6
ER16 SPR .238-.278 AA	1/4 (.238-.278)	6.0- 7
ER16 SPR .278-.317 AA	5/16 (.278-.317)	7.0- 8
ER16 SPR .317-.356 AA	11/32 (.317-.356)	8.0- 9
ER16 SPR .356-.396 AA	3/8 (.356-.396)	9.0-10
ER20 SPR .041-.080 AA	1/16 (.041-.080)	1.0- 2
ER20 SPR .080-.120 AA	3/32 (.080-.120)	2.0- 3
ER20 SPR .120-.159 AA	1/8 (.120-.159)	3.0- 4
ER20 SPR .159-.199 AA	3/16 (.159-.199)	4.0- 5
ER20 SPR .199-.238 AA	7/32 (.199-.238)	5.0- 6
ER20 SPR .238-.278 AA	1/4 (.238-.278)	6.0- 7
ER20 SPR .278-.317 AA	5/16 (.278-.317)	7.0- 8
ER20 SPR .317-.356 AA	11/32 (.317-.356)	8.0- 9
ER20 SPR .356-.396 AA	3/8 (.356-.396)	9.0-10
ER20 SPR .396-.435 AA	13/32 (.396-.435)	10.0-11
ER20 SPR .435-.474 AA	7/16 (.435-.474)	11.0-12
ER20 SPR .474-.514 AA	1/2 (.474-.514)	12.0-13
ER25 SPR .041-.080 AA	1/16 (.041-.080)	1 - 2
ER25 SPR .080-.120 AA	3/32 (.080-.120)	2 - 3
ER25 SPR .120-.159 AA	1/8 (.120-.159)	3 - 4
ER25 SPR .159-.199 AA	3/16 (.159-.199)	4 - 5
ER25 SPR .199-.238 AA	7/32 (.199-.238)	5 - 6
ER25 SPR .238-.278 AA	1/4 (.238-.278)	6 - 7
ER25 SPR .278-.317 AA	5/16 (.278-.317)	7 - 8
ER25 SPR .317-.356 AA	11/32 (.317-.356)	8 - 9
ER25 SPR .356-.396 AA	3/8 (.356-.396)	9 - 10
ER25 SPR .396-.435 AA	13/32 (.396-.435)	10 - 11
ER25 SPR .435-.474 AA	7/16 (.435-.474)	11 - 12
ER25 SPR .474-.514 AA	1/2 (.474-.514)	12 - 13
ER25 SPR .514-.553 AA	17/32 (.514-.553)	13 - 14
ER25 SPR .553-.593 AA	9/16 (.553-.593)	14 - 15
ER25 SPR .593-.632 AA	5/8 (.593-.632)	15 - 16

ER32, 40-SPR-AA

Designation	Diameter Range	Diameter Range (mm)
ER32 SPR .080-.120 AA	3/32 (.080-.120)	2- 3
ER32 SPR .120-.159 AA	1/8 (.120-.159)	3- 4
ER32 SPR .159-.199 AA	3/16 (.159-.199)	4- 5
ER32 SPR .199-.238 AA	7/32 (.199-.238)	5- 6
ER32 SPR .238-.278 AA	1/4 (.238-.278)	6- 7
ER32 SPR .278-.317 AA	5/16 (.278-.317)	7- 8
ER32 SPR .317-.356 AA	11/32 (.317-.356)	8- 9
ER32 SPR .356-.396 AA	3/8 (.356-.396)	9-10
ER32 SPR .396-.435 AA	13/32 (.396-.435)	10-11
ER32 SPR .435-.474 AA	7/16 (.435-.474)	11-12
ER32 SPR .474-.514 AA	1/2 (.474-.514)	12-13
ER32 SPR .514-.553 AA	17/32 (.514-.553)	13-14
ER32 SPR .553-.593 AA	9/16 (.553-.593)	14-15
ER32 SPR .593-.632 AA	5/8 (.593-.632)	15-16
ER32 SPR .632-.671 AA	21/32 (.632-.671)	16-17
ER32 SPR .671-.711 AA	11/16 (.671-.711)	17-18
ER32 SPR .711-.750 AA	3/4 (.711-.750)	18-19
ER32 SPR .750-.789 AA	25/32 (.750-.789)	19-20
ER40 SPR .120-.159 AA	1/8 (.120-.159)	3- 4
ER40 SPR .159-.199 AA	3/16 (.159-.199)	4- 5
ER40 SPR .199-.238 AA	7/32 (.199-.238)	5- 6
ER40 SPR .238-.278 AA	1/4 (.238-.278)	6- 7
ER40 SPR .278-.317 AA	5/16 (.278-.317)	7- 8
ER40 SPR .317-.356 AA	11/32 (.317-.356)	8- 9
ER40 SPR .356-.396 AA	3/8 (.356-.396)	9-10
ER40 SPR .396-.435 AA	13/32 (.396-.435)	10-11
ER40 SPR .435-.474 AA	7/16 (.435-.474)	11-12
ER40 SPR .474-.514 AA	1/2 (.474-.514)	12-13
ER40 SPR .514-.553 AA	17/32 (.514-.553)	13-14
ER40 SPR .553-.593 AA	9/16 (.553-.593)	14-15
ER40 SPR .593-.632 AA	5/8 (.593-.632)	15-16
ER40 SPR .632-.671 AA	21/32 (.632-.671)	16-17
ER40 SPR .671-.711 AA	11/16 (.671-.711)	17-18
ER40 SPR .711-.750 AA	3/4 (.711-.750)	18-19
ER40 SPR .750-.789 AA	25/32 (.750-.789)	19-20
ER40 SPR .789-.829 AA	13/16 (.789-.829)	20-21
ER40 SPR .829-.868 AA	27/32 (.829-.868)	21-22
ER40 SPR .868-.907 AA	7/8 (.868-.907)	22-23
ER40 SPR .907-.947 AA	15/16 (.907-.947)	23-24
ER40 SPR .947-.986 AA	31/32 (.947-.986)	24-25
ER40 SPR .986-1.025 AA	1 (.986-1.025)	25-26

ER COOLIT - SEALED JET COLLET 1450 PSI



ER16, 20, 25-SEAL

Designation	Diameter Range	Diameter Range (mm)
ER16 SEAL .120-.159	1/8 (.120-.159)	3- 4
ER16 SEAL .159-.199	3/16 (.159-.199)	4- 5
ER16 SEAL .199-.238	7/32 (.199-.238)	5- 6
ER16 SEAL .238-.278	1/4 (.238-.278)	6- 7
ER16 SEAL .278-.317	5/16 (.278-.317)	7- 8
ER16 SEAL .317-.356	11/32 (.317-.356)	8- 9
ER16 SEAL .356-.396	3/8 (.356-.396)	9-10
ER20 SEAL .120-.159	1/8 (.120-.159)	3- 4
ER20 SEAL .159-.199	3/16 (.159-.199)	4- 5
ER20 SEAL .199-.238	7/32 (.199-.238)	5- 6
ER20 SEAL .238-.278	1/4 (.238-.278)	6- 7
ER20 SEAL .278-.317	5/16 (.278-.317)	7- 8
ER20 SEAL .317-.356	11/32 (.317-.356)	8- 9
ER20 SEAL .356-.396	3/8 (.356-.396)	9-10
ER20 SEAL .396-.435	13/32 (.396-.435)	10-11
ER20 SEAL .435-.474	7/16 (.435-.474)	11-12
ER20 SEAL .474-.514	1/2 (.474-.514)	12-13
ER25 SEAL .120-.159	1/8 (.120-.159)	3- 4
ER25 SEAL .159-.199	3/16 (.159-.199)	4- 5
ER25 SEAL .199-.238	7/32 (.199-.238)	5- 6
ER25 SEAL .238-.278	1/4 (.238-.278)	6- 7
ER25 SEAL .278-.317	5/16 (.278-.317)	7- 8
ER25 SEAL .317-.356	11/32 (.317-.356)	8- 9
ER25 SEAL .356-.396	3/8 (.356-.396)	9-10
ER25 SEAL .396-.435	13/32 (.396-.435)	10-11
ER25 SEAL .435-.474	7/16 (.435-.474)	11-12
ER25 SEAL .474-.514	1/2 (.474-.514)	12-13
ER25 SEAL .514-.553	17/32 (.514-.553)	13-14
ER25 SEAL .553-.593	9/16 (.553-.593)	14-15
ER25 SEAL .593-.632	5/8 (.593-.632)	15-16

Note: When clamping a tool in the lower .012" (for example .323") of the clamping range (the full collapsibility range is .40"), the runout of the tool in the sealed collet may sometimes exceed the .0004" tolerance. In these cases a special collet of the exact size should be ordered.

ER32, 20, 40-SEAL

Designation	Diameter Range	Diameter Range (mm)
ER32 SEAL .120-.159	1/8 (.120-.159)	3- 4
ER32 SEAL .159-.199	3/16 (.159-.199)	4- 5
ER32 SEAL .199-.238	7/32 (.199-.238)	5- 6
ER32 SEAL .238-.278	1/4 (.238-.278)	6- 7
ER32 SEAL .278-.317	5/16 (.278-.317)	7- 8
ER32 SEAL .317-.356	11/32 (.317-.356)	8- 9
ER32 SEAL .356-.396	3/8 (.356-.396)	9-10
ER32 SEAL .396-.435	13/32 (.396-.435)	10-11
ER32 SEAL .435-.474	7/16 (.435-.474)	11-12
ER32 SEAL .474-.514	1/2 (.474-.514)	12-13
ER32 SEAL .514-.553	17/32 (.514-.553)	13-14
ER32 SEAL .553-.593	9/16 (.553-.593)	14-15
ER32 SEAL .593-.632	5/8 (.593-.632)	15-16
ER32 SEAL .632-.671	21/32 (.632-.671)	16-17
ER32 SEAL .671-.711	11/16 (.671-.711)	17-18
ER32 SEAL .711-.750	3/4 (.711-.750)	18-19
ER32 SEAL .750-.789	25/32 (.750-.789)	19-20
ER40 SEAL .120-.159	1/8 (.120-.159)	3- 4
ER40 SEAL .159-.199	3/16 (.159-.199)	4- 5
ER40 SEAL .199-.238	7/32 (.199-.238)	5- 6
ER40 SEAL .238-.278	1/4 (.238-.278)	6- 7
ER40 SEAL .278-.317	5/16 (.278-.317)	7- 8
ER40 SEAL .317-.356	11/32 (.317-.356)	8- 9
ER40 SEAL .356-.396	3/8 (.356-.396)	9-10
ER40 SEAL .396-.435	13/32 (.396-.435)	10-11
ER40 SEAL .435-.474	7/16 (.435-.474)	11-12
ER40 SEAL .474-.514	1/2 (.474-.514)	12-13
ER40 SEAL .514-.553	17/32 (.514-.553)	13-14
ER40 SEAL .553-.593	9/16 (.553-.593)	14-15
ER40 SEAL .593-.632	5/8 (.593-.632)	15-16
ER40 SEAL .632-.671	21/32 (.632-.671)	16-17
ER40 SEAL .671-.711	11/16 (.671-.711)	17-18
ER40 SEAL .711-.750	3/4 (.711-.750)	18-19
ER40 SEAL .750-.789	25/32 (.750-.789)	19-20
ER40 SEAL .789-.829	13/16 (.789-.829)	20-21
ER40 SEAL .829-.868	27/32 (.829-.868)	21-22
ER40 SEAL .868-.907	7/8 (.868-.907)	22-23
ER40 SEAL .907-.947	15/16 (.907-.947)	23-24
ER40 SEAL .947-.986	31/32 (.947-.986)	24-25
ER40 SEAL .986-1.025	1 (.986-1.025)	25-26

ER COOLIT - SEALED JET2 SPRING COLLETS 1450 PSI

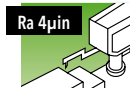

ER16, 20, 25-SEAL-JET2

Designation	Diameter Range	Diameter Range (mm)
ER16 SEAL .120-.159 JET2	1/8 (.120-.159)	3- 4
ER16 SEAL .159-.199 JET2	3/16 (.159-.199)	4- 5
ER16 SEAL .199-.238 JET2	7/32 (.199-.238)	5- 6
ER16 SEAL .238-.278 JET2	1/4 (.238-.278)	6- 7
ER16 SEAL .278-.317 JET2	5/16 (.278-.317)	7- 8
ER16 SEAL .317-.356 JET2	11/32 (.317-.356)	8- 9
ER16 SEAL .356-.396 JET2	3/8 (.356-.396)	9-10
ER20 SEAL .120-.159 JET2	1/8 (.120-.159)	3- 4
ER20 SEAL .159-.199 JET2	3/16 (.159-.199)	4- 5
ER20 SEAL .199-.238 JET2	7/32 (.199-.238)	5- 6
ER20 SEAL .238-.278 JET2	1/4 (.238-.278)	6- 7
ER20 SEAL .278-.317 JET2	5/16 (.278-.317)	7- 8
ER20 SEAL .317-.356 JET2	11/32 (.317-.356)	8- 9
ER20 SEAL .356-.396 JET2	3/8 (.356-.396)	9-10
ER20 SEAL .396-.435 JET2	13/32 (.396-.435)	10-11
ER20 SEAL .435-.474 JET2	7/16 (.435-.474)	11-12
ER20 SEAL .474-.514 JET2	1/2 (.474-.514)	12-13
ER25 SEAL .120-.159 JET2	1/8 (.120-.159)	3- 4
ER25 SEAL .159-.199 JET2	3/16 (.159-.199)	4- 5
ER25 SEAL .199-.238 JET2	7/32 (.199-.238)	5- 6
ER25 SEAL .238-.278 JET2	1/4 (.238-.278)	6- 7
ER25 SEAL .278-.317 JET2	5/16 (.278-.317)	7- 8
ER25 SEAL .317-.356 JET2	11/32 (.317-.356)	8- 9
ER25 SEAL .356-.396 JET2	3/8 (.356-.396)	9-10
ER25 SEAL .396-.435 JET2	13/32 (.396-.435)	10-11
ER25 SEAL .435-.474 JET2	7/16 (.435-.474)	11-12
ER25 SEAL .474-.514 JET2	1/2 (.474-.514)	12-13
ER25 SEAL .514-.553 JET2	17/32 (.514-.553)	13-14
ER25 SEAL .553-.593 JET2	9/16 (.553-.593)	14-15
ER25 SEAL .593-.632 JET2	5/8 (.593-.632)	15-16

Note: When clamping a tool in the lower .012" (for example .323") of the clamping range (the full collapsibility range is .40"), the runout of the tool in the sealed collet may sometimes exceed the .0004" tolerance. In these cases a special collet of the exact size should be ordered.

ER32, 40-SEAL-JET2

Designation	Diameter Range	Diameter Range (mm)
ER32 SEAL .120-.159 JET2	1/8 (.120-.159)	3- 4
ER32 SEAL .159-.199 JET2	3/16 (.159-.199)	4- 5
ER32 SEAL .199-.238 JET2	7/32 (.199-.238)	5- 6
ER32 SEAL .238-.278 JET2	1/4 (.238-.278)	6- 7
ER32 SEAL .278-.317 JET2	5/16 (.278-.317)	7- 8
ER32 SEAL .317-.356 JET2	11/32 (.317-.356)	8- 9
ER32 SEAL .356-.396 JET2	3/8 (.356-.396)	9-10
ER32 SEAL .396-.435 JET2	13/32 (.396-.435)	10-11
ER32 SEAL .435-.474 JET2	7/16 (.435-.474)	11-12
ER32 SEAL .474-.514 JET2	1/2 (.474-.514)	12-13
ER32 SEAL .514-.553 JET2	17/32 (.514-.553)	13-14
ER32 SEAL .553-.593 JET2	9/16 (.553-.593)	14-15
ER32 SEAL .593-.632 JET2	5/8 (.593-.632)	15-16
ER32 SEAL .632-.671 JET2	21/32 (.632-.671)	16-17
ER32 SEAL .671-.711 JET2	11/16 (.671-.711)	17-18
ER32 SEAL .711-.750 JET2	3/4 (.711-.750)	18-19
ER32 SEAL .750-.789 JET2	25/32 (.750-.789)	19-20
ER40 SEAL .120-.159 JET2	1/8 (.120-.159)	3- 4
ER40 SEAL .159-.199 JET2	3/16 (.159-.199)	4- 5
ER40 SEAL .199-.238 JET2	7/32 (.199-.238)	5- 6
ER40 SEAL .238-.278 JET2	1/4 (.238-.278)	6- 7
ER40 SEAL .278-.317 JET2	5/16 (.278-.317)	7- 8
ER40 SEAL .317-.356 JET2	11/32 (.317-.356)	8- 9
ER40 SEAL .356-.396 JET2	3/8 (.356-.396)	9-10
ER40 SEAL .396-.435 JET2	13/32 (.396-.435)	10-11
ER40 SEAL .435-.474 JET2	7/16 (.435-.474)	11-12
ER40 SEAL .474-.514 JET2	1/2 (.474-.514)	12-13
ER40 SEAL .514-.553 JET2	17/32 (.514-.553)	13-14
ER40 SEAL .553-.593 JET2	9/16 (.553-.593)	14-15
ER40 SEAL .593-.632 JET2	5/8 (.593-.632)	15-16
ER40 SEAL .632-.671 JET2	21/32 (.632-.671)	16-17
ER40 SEAL .671-.711 JET2	11/16 (.671-.711)	17-18
ER40 SEAL .711-.750 JET2	3/4 (.711-.750)	18-19
ER40 SEAL .750-.789 JET2	25/32 (.750-.789)	19-20
ER40 SEAL .789-.829 JET2	13/16 (.789-.829)	20-21
ER40 SEAL .829-.868 JET2	27/32 (.829-.868)	21-22
ER40 SEAL .868-.907 JET2	7/8 (.868-.907)	22-23
ER40 SEAL .907-.947 JET2	15/16 (.907-.947)	23-24
ER40 SEAL .947-.986 JET2	31/32 (.947-.986)	24-25
ER40 SEAL .986-1.025 JET2	1 (.986-1.025)	25-26

ER SPRING COLLET SETS



46-48 HRC



Ra 4µin

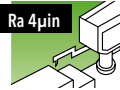

SET-ER SPR Spring Collets DIN 6499

Designation	Pcs.	Diameter Range	Diameter Range (mm)
SET ER11 SPR 7	7	.022- .278	0.5- 7
SET ER16 SPR 10	10	.022- .396	0.5-10
SET ER20 SPR 12	12	.041- .514	1.0-13
SET ER25 SPR 15	15	.041- .632	1.0-16
SET ER32 SPR 18	18	.080- .789	2.0-20
SET ER40 SPR 23	23	.120-1.025	3.0-26
SET ER50 SPR 12	12	.396-1.338	10.0-34



SET-ER-SPR-AA Spring Collets DIN 6499 "AA"

Designation	Pcs.	Diameter Range	Diameter Range (mm)
SET ER11 SPR 7 AA	7	.022- .278	0.5- 7
SET ER16 SPR 10 AA	10	.022- .396	0.5-10
SET ER20 SPR 12 AA	12	.041- .514	1.0-13
SET ER25 SPR 15 AA	15	.041- .632	1.0-16
SET ER32 SPR 18 AA	18	.080- .789	2.0-20
SET ER40 SPR 23 AA	23	.120-1.025	3.0-26

ER COOLIT - SEALED JETS COLLET SETS 1450 PSI

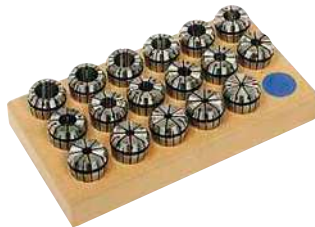

46-48 HRC



Ra 4µin



SET-ER-SEAL Collets DIN 6499

Designation	Pcs.	Diameter Range	Diameter Range (mm)
SET ER16 SEAL 7	7	.120- .396	3-10
SET ER20 SEAL 10	10	.120- .514	3-13
SET ER25 SEAL 13	13	.120- .632	3-16
SET ER32 SEAL 17	17	.120- .789	3-20
SET ER40 SEAL 23	23	.120-1.025	3-26



SET-ER-SEAL-JET2 Collet DIN 6499

Designation	Pcs.	Diameter Range	Diameter Range (mm)
SET ER16 SEAL 7 JET2	7	.120- .396	3-10
SET ER20 SEAL 10 JET2	10	.120- .514	3-13
SET ER25 SEAL 13 JET2	13	.120- .632	3-16
SET ER32 SEAL 17 JET2	17	.120- .789	3-20
SET ER40 SEAL 23 JET2	23	.120-1.025	3-26

Note: When clamping a tool in the lower .012" (for example .323") of the clamping range (the full collapsibility range is .40"), the runout of the tool in the sealed collet may sometimes exceed the .0004" tolerance. In these cases a special collet of the exact size should be ordered.

ER SPRING EMI COLLET SETS DIN 6499



SET ER SPR-EMI ⁽¹⁾

Designation	Pcs.	Collet Sizes
SET ER16 SPR 5 EMI	5	1/8, 3/16, 1/4, 5/16, 3/8
SET ER20 SPR 5 EMI	5	3/16, 1/4, 5/16, 3/8, 1/2
SET ER25 SPR 6 EMI	6	3/16, 1/4, 5/16, 3/8, 1/2, 5/8
SET ER32 SPR 6 EMI	6	1/4, 3/16, 5/16, 3/8, 1/2, 5/8, 3/4
SET ER40 SPR 7 EMI	7	1/4, 3/16, 5/16, 3/8, 1/2, 5/8, 3/4, 1

(1) EMI-Endmill cutter in inch sizes.

46-48 HRc



Ra 4µin



ER COOLIT - SEALED JET EMI COLLET SETS



SET ER SPR-EMI ⁽¹⁾

Designation	Pcs.	Collet Sizes
SET ER 16 SEAL 5 EMI	5	1/8, 3/16, 1/4, 5/16, 3/8
SET ER 20 SEAL 5 EMI	5	1/8, 3/16, 1/4, 5/16, 3/8, 1/2
SET ER 25 SEAL 6 EMI	6	1/8, 3/16, 1/4, 5/16, 3/8, 1/2, 5/8
SET ER 32 SEAL 6 EMI	6	3/16, 1/4, 5/16, 3/8, 1/2, 5/8, 3/4
SET ER 40 SEAL 7 EMI	7	3/16, 1/4, 5/16, 3/8, 1/2, 5/8, 3/4, 1

(1) EMI-Endmill cutter in inch sizes.

1450 psi

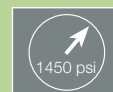

46-48 HRc



Ra 4µin



SET-ER SEAL-EMI JET2

Designation	Set Pcs.	Collet Sizes
SET ER 16 SEAL 5 EMI JET2	5	1/8, 3/16, 1/4, 5/16, 3/8
SET ER 20 SEAL 5 EMI JET2	5	1/8, 3/16, 1/4, 5/16, 3/8, 1/2
SET ER 25 SEAL 6 EMI JET2	6	1/8, 3/16, 1/4, 5/16, 3/8, 1/2, 5/8
SET ER 32 SEAL 6 EMI JET2	6	3/16, 1/4, 5/16, 3/8, 1/2, 5/8, 3/4
SET ER 40 SEAL 7 EMI JET2	7	3/16, 1/4, 5/16, 3/8, 1/2, 5/8, 3/4, 1

1450 psi



46-48 HRc



Ra 4µin



Note: When clamping a tool in the lower .012" (for example .323") of the clamping range (the full collapsibility range is .40"), the runout of the tool in the sealed collet may sometimes exceed the .0004" tolerance. In these cases a special collet of the exact size should be ordered.

INGERSOLL

THERMAL SHRINK CHUCKING SYSTEMS

SHRINKIN thermal shrinking collets are an enhancement to the existing popular ER collet system. The SHRINKIN collets utilize the thermal expansion and shrink phenomenon for rigid clamping of steel, HSS and solid carbide tools. SHRINKIN collets provide high torque, precision runout and excellent repeatability.

The SHRINKIN ER collets with their slim design and various projection lengths allow the user to reach deep cavities and perform narrow milling applications.

Ingersoll offers a complete system for the SHRINKIN collets with integral ER or other standard, integral tapered shanks.

The conventional, thermal shrink chucking unit can be used only for solid carbide tools, clamped into SRK ER collets. The induction thermal unit can be used for steel, HSS and solid carbide tools. It can be used for both SRK and SRKIN collets with ER or other integral tapered shanks.



**Clamping Time
15-45 seconds**

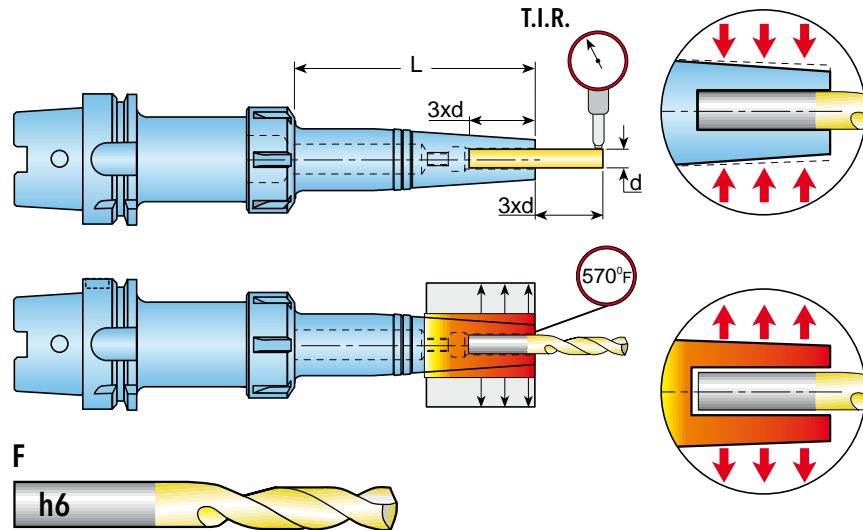

L (inch)	Max T.I.R
1.500	.00030
2.500	.00035
3.500	.00040

Features:

- Slim design with various projections
- Flexible - fits into standard ER chucks
- High torque transfer
- Rigid clamping of carbide tools
- Precision runout
- Perfect repeatability
- Vibration damping
- Coolant through the tool
- Coolant Jet2 available
- Symmetrical design for high speed machining
- Quick and easy tool changing
- Two types of thermal heating units

THERMAL SHRINK CHUCKING SYSTEM

Standard ER Collet Chucks

...HSK 40, 50, 63, 100



...BT 30, 40, 50



...CAT 30, 40, 50



...ISO 30, 40, 50



SHORTIN

CAT 40, 50
 BT 40, 50
 HSK 63, 100



SHRINKIN ER Collet Compatible with Standard ER Collets DIN 6499

ER20
 ER25
 ER32



Integral Holder

HSK A/E-SRK



CAT-SRK

BT-SRK



ER - THERMAL SHRINK ER COLLET DIN 6499

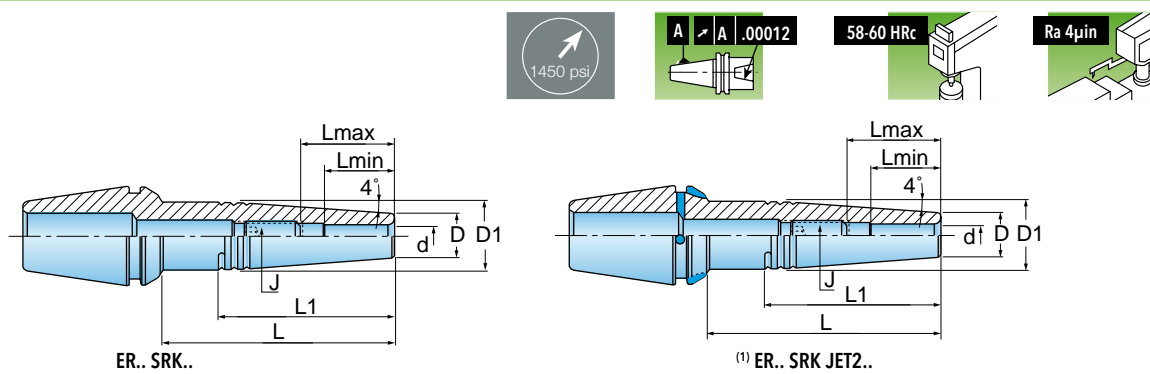

Designation	d	L	L1	Lmin	Lmax	D1	D	J	Hex Key ⁽²⁾
ER20 SRK 1/8X1.500	.125	1.500	.970	.394	.630	.530	.394	M6	3
ER20 SRK 1/8X2.500	.125	2.500	.970	.394	.630	.530	.394	M6	3
ER20 SRK 3/16X1.500	.187	1.500	.970	.590	.830	.530	.394	M6	3
ER20 SRK 3/16X2.500	.187	2.500	.970	.590	.830	.530	.394	M6	3
ER20 SRK 1/4X1.500	.250	1.500	1.140	.709	.950	.590	.433	M8	4
ER20 SRK 1/4X2.500	.250	2.500	1.310	.709	.950	.620	.433	M8	4
ER25 SRK 1/8X1.500	.125	1.500	1.110	.394	.630	.550	.394	M6	3
ER25 SRK 1/8X2.500	.125	2.500	1.710	.394	.630	.630	.394	M6	3
ER25 SRK 3/16X1.500	.187	1.500	1.110	.590	.830	.550	.394	M6	3
ER25 SRK 3/16X2.500	.187	2.500	1.710	.590	.830	.630	.394	M6	3
ER25 SRK 1/4X1.500	.250	1.500	1.140	.709	.950	.590	.433	M8	4
ER25 SRK 1/4X2.500	.250	2.500	1.900	.709	.950	.700	.433	M8	4
ER25 SRK 5/16X1.500	.313	1.500	1.080	.984	1.220	.710	.551	M10	5
ER25 SRK 5/16X2.500	.313	2.500	1.710	.984	1.220	.790	.551	M10	5
ER32 SRK 1/8X1.500	.125	1.500	1.100	.394	.630	.550	.394	M6	3
ER32 SRK 1/8X2.500	.125	2.500	2.000	.394	.630	.680	.394	M6	3
ER32 SRK 1/8X3.500	.125	3.500	3.000	.394	.630	.820	.394	M6	3
ER32 SRK 3/16X1.500	.187	1.500	1.110	.590	.830	.550	.394	M6	3
ER32 SRK 3/16X2.500	.187	2.500	1.900	.590	.830	.660	.394	M6	3
ER32 SRK 3/16X3.500	.187	3.500	2.900	.590	.830	.800	.394	M6	3
ER32 SRK 1/4X1.500	.250	1.500	1.140	.709	.950	.590	.433	M8	4
ER32 SRK 1/4X2.500	.250	2.500	1.910	.709	.965	.700	.433	M8	4
ER32 SRK 1/4X3.500	.250	3.500	2.900	.709	1.020	.840	.433	M8	4
ER32 SRK 5/16X1.500	.312	1.500	1.440	.984	1.220	.760	.551	M10	5
ER32 SRK 5/16X2.500	.312	2.500	1.910	.984	1.220	.820	.551	M10	5
ER32 SRK 5/16X3.500	.312	3.500	2.710	.984	1.220	.930	.551	M10	5
ER32 SRK 3/8X1.500	.375	1.500	1.460	1.181	1.380	.840	.629	M12	6
ER32 SRK 3/8X2.500	.375	2.500	1.900	1.181	1.420	.900	.629	M12	6
ER32 SRK 3/8X3.500	.375	3.500	2.120	1.181	1.420	.930	.629	M12	6
ER32 SRK 7/16X1.500	.437	1.500	1.110	1.220	1.420	.940	.787	M14	6
ER32 SRK 7/16X2.500	.437	2.500	1.110	1.220	1.460	.940	.787	M14	6
ER32 SRK 7/16X3.500	.437	3.500	1.110	1.220	1.460	.940	.787	M14	6
ER32 SRK 1/2X1.500	.500	1.500	1.100	1.260	1.460	.940	.787	M14	6
ER32 SRK 1/2X2.500	.500	2.500	1.100	1.260	1.500	.940	.787	M14	6
ER32 SRK 1/2X3.500	.500	3.500	1.410	1.260	1.500	.940	.787	M14	6

(1) For JET2 collet, add JET2 to the designation (i.e. ER20 SRK 1/8X1 JET2).

(2) Metric

ER - SHRINK ER COLLET DIN 6499 - METRIC

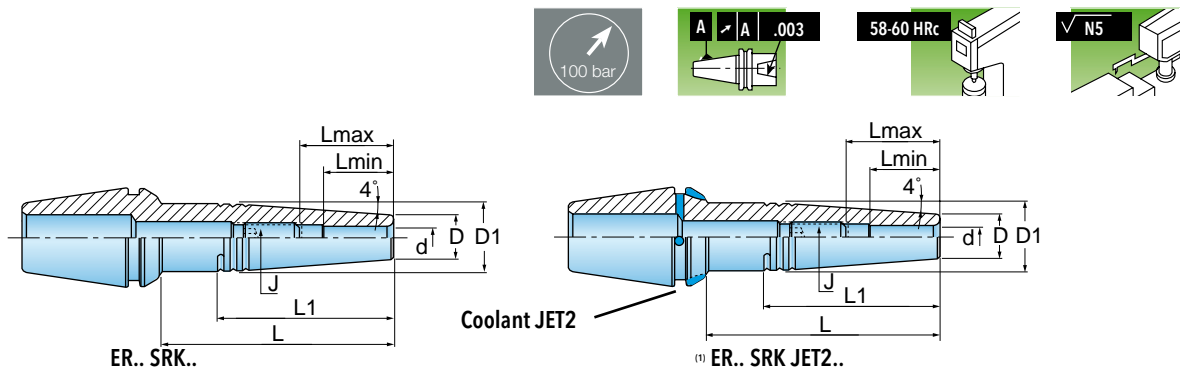

Designation	d	L	L1	Lmin	Lmax	D1	D	J	Hex Key
ER20 SRK 3X35	3.00	35.00	24.5	10.0	16.00	13.5	10.0	M6	3
ER20 SRK 3X60	3.00	60.00	24.5	10.0	16.00	13.5?	10.0	M6	3
ER20 SRK 4X35	4.00	35.00	24.5	12.0	18.00	13.5	10.0	M6	3
ER20 SRK 4X60	4.00	60.00	24.5	12.0	18.00	13.5	10.0	M6	3
ER20 SRK 5X35	5.00	35.00	24.5	15.0	21.00	13.5	10.0	M6	3
ER20 SRK 5X60	5.00	60.00	24.5	15.0	21.00	13.5	10.0	M6	3
ER20 SRK 6X35	6.00	35.00	25.5	18.0	24.00	14.7	11.0	M8	4
ER20 SRK 6X60	6.00	60.00	29.5	18.0	24.00	15.2	11.0	M8	4
ER25 SRK 3X35	3.00	35.00	24.5	10.0	16.00	13.5	10.0	M6	3
ER25 SRK 3X60	3.00	60.00	44.5	10.0	16.00	16.3	10.0	M6	3
ER25 SRK 4X35	4.00	35.00	24.5	12.0	18.00	13.5	10.0	M6	3
ER25 SRK 4X60	4.00	60.00	44.5	12.0	18.00	16.3	10.0	M6	3
ER25 SRK 5X35	5.00	35.00	24.5	15.0	21.00	13.5	10.0	M6	3
ER25 SRK 5X60	5.00	60.00	44.5	15.0	21.00	16.3	10.0	M6	3
ER25 SRK 6X35	6.00	35.00	26.0	18.0	24.00	14.7	11.0	M8	4
ER25 SRK 6X60	6.00	60.00	44.5	18.0	24.00	17.3	11.0	M8	4
ER25 SRK 8X35	8.00	35.00	26.5	25.0	30.00	17.8	14.0	M10	5
ER25 SRK 8X60	8.00	60.00	39.5	25.0	31.00	19.7	14.0	M10	5
ER32 SRK 3X35	3.00	35.00	22.5	10.0	16.00	13.2	10.0	M6	3
ER32 SRK 3X60	3.00	60.00	44.5	10.0	16.00	16.3	10.0	M6	3
ER32 SRK 3X85	3.00	85.00	70.0	10.0	16.00	19.8	10.0	M6	3
ER32 SRK 4X35	4.00	35.00	23.5	12.0	18.00	13.4	10.0	M6	3
ER32 SRK 4X60	4.00	60.00	44.5	12.0	18.00	16.3	10.0	M6	3
ER32 SRK 4X85	4.00	85.00	70.0	12.0	18.00	19.8	10.0	M6	3
ER32 SRK 5X35	5.00	35.00	24.5	15.0	21.00	13.5	10.0	M6	3
ER32 SRK 5X60	5.00	60.00	44.5	15.0	21.00	16.3	10.0	M6	3
ER32 SRK 5X85	5.00	85.00	70.0	15.0	21.00	19.8	10.0	M6	3
ER32 SRK 6X35	6.00	35.00	25.5	18.0	24.00	14.7	11.0	M8	4
ER32 SRK 6X60	6.00	60.00	45.0	18.0	24.00	17.3	11.0	M8	4
ER32 SRK 6X85	6.00	85.00	69.5	18.0	26.00	20.8	11.0	M8	4
ER32 SRK 8X35	8.00	35.00	33.0	25.0	31.00	18.8	14.0	M10	5
ER32 SRK 8X60	8.00	60.00	45.0	25.0	31.00	20.4	14.0	M10	5
ER32 SRK 8X85	8.00	85.00	65.0	25.0	31.00	23.2	14.0	M10	5
ER32 SRK 10X35	10.00	35.00	34.0	30.0	35.00	20.8	16.0	M12	6
ER32 SRK 10X60	10.00	60.00	44.5	30.0	36.00	22.4	16.0	M12	6
ER32 SRK 10X85	10.00	85.00	49.5	30.0	36.00	23.0	16.0	M12	6
ER32 SRK 12X35	12.00	35.00	28.0	32.0		24.0	20.0		
ER32 SRK 12X60	12.00	60.00	28.0	32.0	38.00	24.0	20.0	M14	6
ER32 SRK 12X85	12.00	85.00	28.0	32.0	38.00	24.0	20.0	M14	6

(1) For JET2 collet, add JET2 to the designations (i.e. ER32 SRK 10x35 JET2).

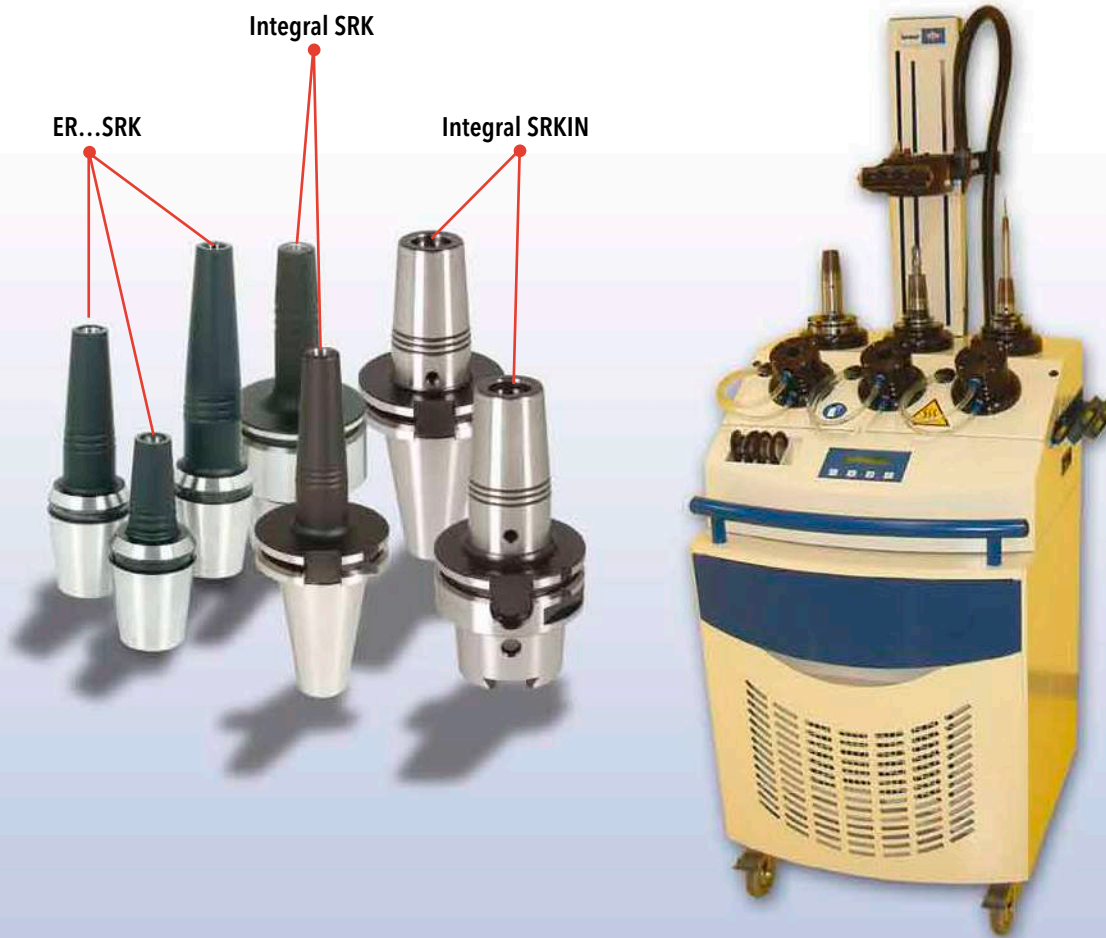

- High operating power (10 kW)
- 3 independent tool post
- Easy and efficient to operate
- Quick tool changing (5 sec.)
- Short cooling time (30 sec.)
- Solid carbide range (1/8- 1 1/4")
- H.S.S. cutter range (1/4- 1 1/4")

Suitable for:

- Integral tooling
- Integral heavy duty tooling
- Extensions
- ER...SRK...unique collets

Technical Specifications:

Clamping range	1/8-11/4"	Carbide tool shank
Clamping range	1/4-11/4"	HSS & steel shank
Main power supply	3 x 380-500V 50/60Hz	
Nominal power	13.4 Hp	
Nominal current	16 AMP	
Cooling unit power supply	110V 50/60Hz	
Nominal power	.67 Hp	
Max. tool length	17.3" (from gauge line)	
Max. dia. clamping chuck	2.04"	
Effective induction field length	1.77"	
Expansion time	approx. 5-12 seconds	
Cooling time	approx. 0.5-1.5 min	
Weight	330 lbs.	
Overall dimensions	66.9 x 28.7 x 28.7"	

QWIK DRAW - SHRINK THERMAL ELECTRICAL UNIT

SHRINKIN Thermal Electrical Unit Designation: IND SHRINKIN UNIT USA

Includes:
Induction Unit, Cooling Unit, Trolley
Three Tool Adapter⁽¹⁾

Cooling Sleeves	Used for
IND COOLING COLLET 6-8 IND COOLING COLLET 10-12 IND COOLING COLLET 14-16 IND COOLING COLLET 18-20	SRKIN
IND COOLING COLLET ER 3-5 IND COOLING COLLET ER 6 IND COOLING COLLET ER 8 IND COOLING COLLET ER 10 IND COOLING COLLET ER 12	SRK
Optional Tool Adapter for HSK	
IND 32 TOOL ADAPTER IND 40 TOOL ADAPTER IND 50 TOOL ADAPTER ⁽¹⁾	

⁽¹⁾ For taper #30

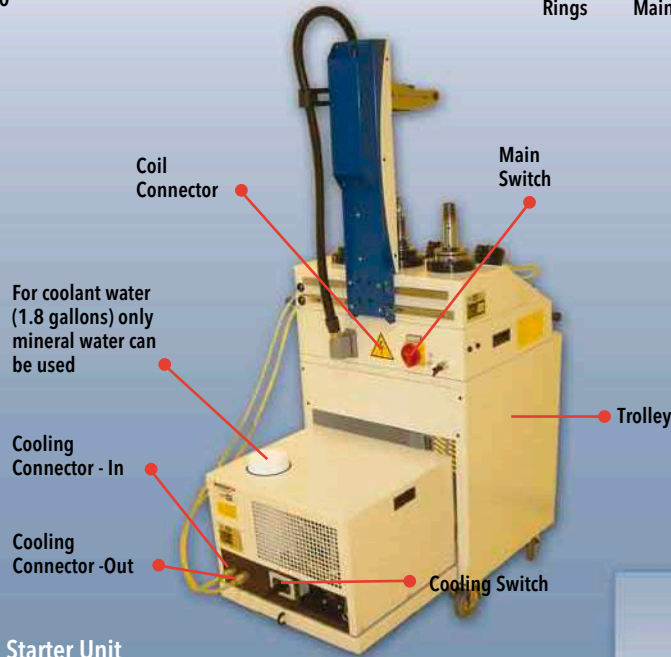
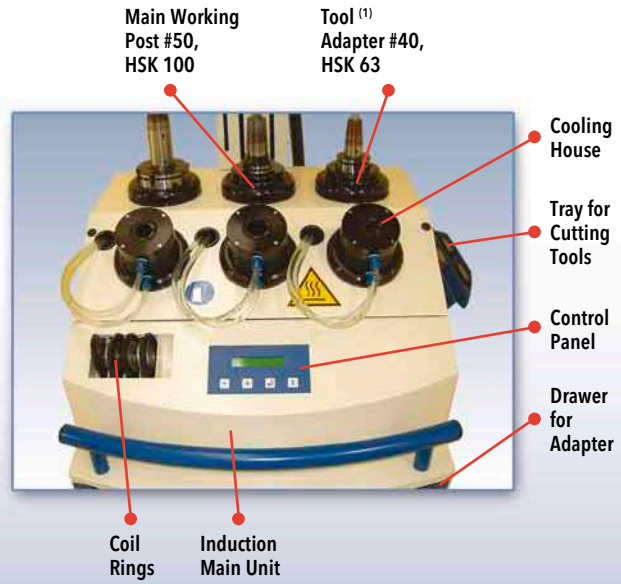

INDUCTION Starter Unit

1 tool post without cooling unit.
The induction starter unit is an economical starter version of the SHRINKIN induction unit. It was designed to help the enduser to purchase the modern shrink chucking technology in a low cost device. The starter unit is actually a simplified and limited version of the complete inductive system that we offer today:

INDUCTION Starter Unit

Designation: IND SHRINKIN START UNIT USA



DRAW IN - THERMAL HEATING UNIT V2 VERSION

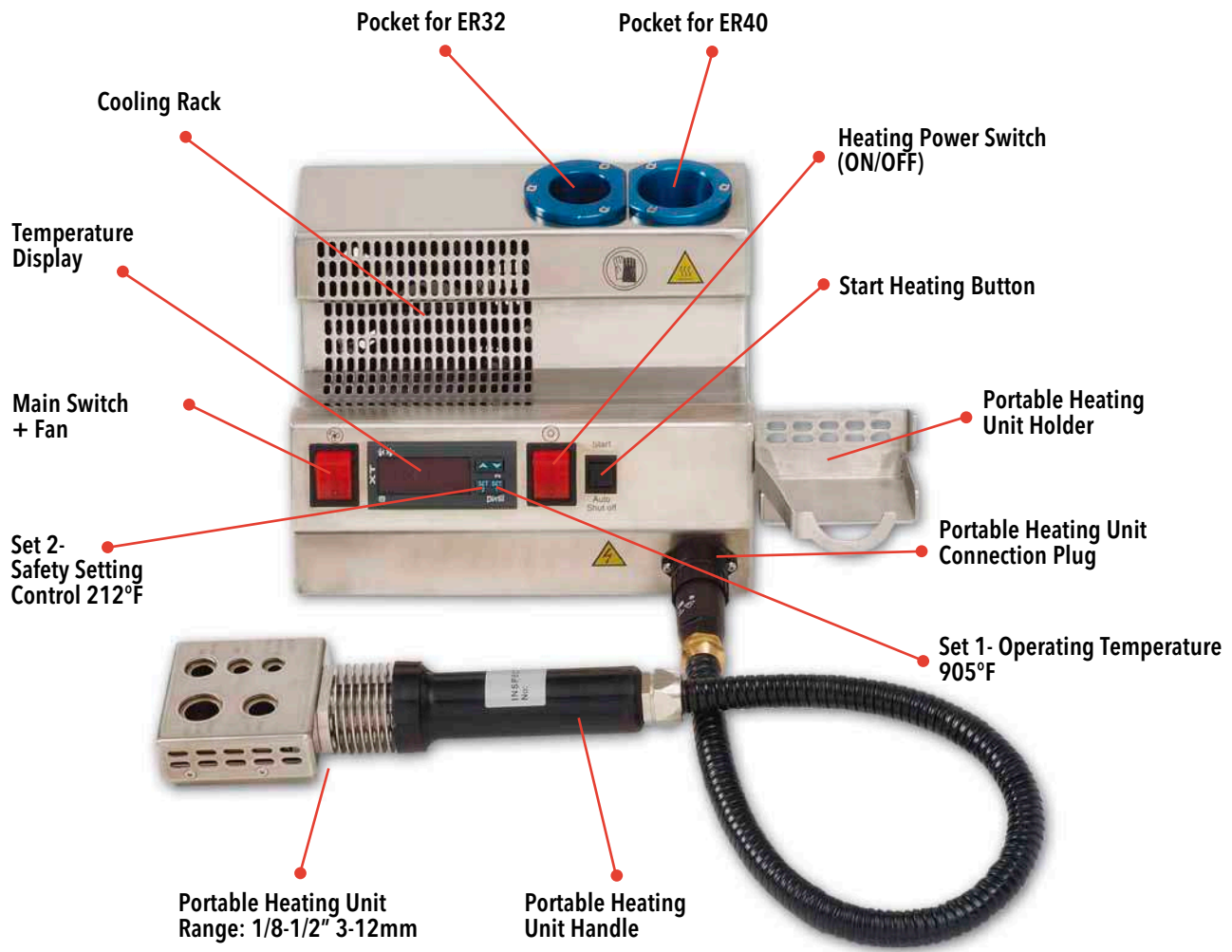

Standard ER Collet Chucks

Designation
SHRINKIN UNIT V2 USA

110V 60 HZ

* Unit includes portable heating handle 110V V2.

Portable Heating Unit Handle

Designation
HEATING HANDLE 110V V2
HEATING HANDLE 16/110V V2
HEATING HANDLE 20/110V V2

Important Note: This thermal heating unit can be used only for heating ER... SRK and ER... SRF collets.



DRAW IN - THERMAL SHRINK SRK ER 32 COLLET SET

SET ER32 SHRINKIN

Designation

SET ER32 SRK S 6 USA
SET ER32 SRK M 6 USA
SET ER32 SRK L 6 USA

(6 Pieces) (3/16, 1/4, 5/16, 3/8, 7/16, 1/2)

For JET2 collet, add JET2 to the designation
(SET ER 32 SRK M 6 JET2 USA)



Thermal Shrink Kit

Designation

KIT SHRINKIN L V2 USA
KIT SHRINKIN M V2 USA
KIT SHRINKIN S V2 USA

Includes:
ER32 SRK 6 Piece Collet Set (3/16, 1/4, 5/16,
3/8, 7/16, 1/2)



GTIN - ER TAPPING COLLET

TAPPING COLLET ISO/DIN/JIS TYPE TENSION AND COMPRESSION FOR CNC & MILLING MACHINES & TURRET LATHES

58-60 HRc

Ra 4µin

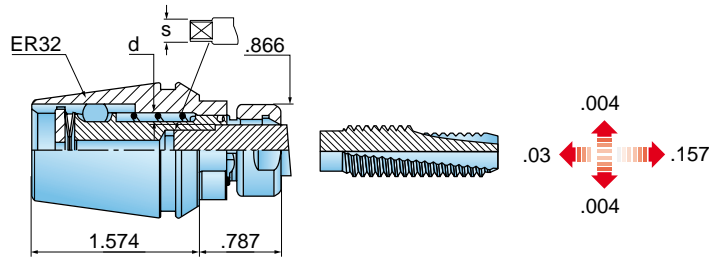

GTIN ER Tapping Collet

Features:

- Fits every type of ER 32 collet chuck stationary and rotating.
- Compensates for machine feed and tap pitch variance.
- Floating mechanism compensates for misalignment between tap and workpiece.
- Hard start for rigid tapping.
- Compact design for minimal clearance.

Designation	d	s	Tap Size
GTIN ER32 ANSI .141X.110	.141	.110	#0-6
GTIN ER32 ANSI .168X.131	.168	.131	#8
GTIN ER32 ANSI .194X.152	.194	.152	#10
GTIN ER32 ANSI .220X.165	.220	.165	#12
GTIN ER32 ANSI .255X.191	.255	.191	1/4
GTIN ER32 ANSI .318X.238	.318	.238	5/16
GTIN ER32 ANSI .381X.286	.381	.286	3/8
GTIN ER32 ANSI .323X.242	.323	.242	7/16
GTIN ER32 ANSI .367X.275	.367	.275	1/2
GTIN ER32 ANSI .429X.322	.429	.322	9/16
GTIN ER32 ANSI .480X.360	.480	.360	5/8

No coolant should be induced through the tapping collet. It will cause malfunctioning of the mechanism.

GTIN - ER TAPPING COLLET

TAPPING COLLET ISO/DIN/JIS TYPE TENSION AND COMPRESSION FOR CNC & MILLING MACHINES & TURRET LATHES

58-60 HRC

✓ N5

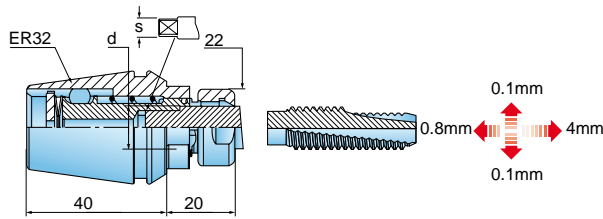

GTIN ER Tapping Collet

Features:

- Fits every type of ER 32 collet chuck stationary and rotating.
- Compensates for machine feed and tap pitch variance.
- Floating mechanism compensates for misalignment between tap and workpiece.
- Hard start for rigid tapping.
- Compact design for minimal clearance.

Designation	d	S	T Wrench	Tap Size
GTIN ER32 ISO 2.24X1.80	2.24	1.80	20	M3
GTIN ER32 ISO 2.50X2.00	2.50	2.00	20	M3.5
GTIN ER32 ISO 2.80X2.24	2.80	2.24	20	M2.2-M2.5
GTIN ER32 ISO 3.15X2.50	3.15	2.50	20	M3-M4
GTIN ER32 ISO 3.55X2.80	3.55	2.80	20	M3.5-M4.5
GTIN ER32 ISO 4.00X3.15	4.00	3.15	20	M4-M5
GTIN ER32 ISO 4.50X3.55	4.50	3.55	20	M6
GTIN ER32 ISO 5.00X4.00	5.00	4.00	20	M5
GTIN ER32 ISO 5.60X4.50	5.60	4.50	20	*
GTIN ER32 ISO 6.30X5.00	6.30	5.00	20	M6-M8
GTIN ER32 ISO 7.10X5.60	7.10	5.60	20	**
GTIN ER32 ISO 8.00X6.30	8.00	6.30	20	M8-M10
GTIN ER32 ISO 9.00X7.10	9.00	7.10	20	M12
GTIN ER32 ISO 10.00X8.00	10.00	8.00	20	M10
GTIN ER32 ISO 11.20X9.00	11.20	9.00	20	M14
GTIN ER32 ISO 12.50X10.0	12.50	10.00	20	M16

* Tap size UNC#12-24

** Tap size UNC#-3/8-16

Designation	d	S	T Wrench	Tap Size
GTIN ER32 DIN 2.50X2.10	2.50	2.10	20	M1-M1.8
GTIN ER32 DIN 2.80X2.10	2.80	2.10	20	M2-M4
GTIN ER32 DIN 3.50X2.70	3.50	2.70	20	M3-M5
GTIN ER32 DIN 4.00X3.00	4.00	3.00	20	M3.M5
GTIN ER32 DIN 4.50X3.40	4.50	3.40	20	M4-M6
GTIN ER32 DIN 6.00X4.90	6.00	4.90	20	M5-M8
GTIN ER32 DIN 7.00X5.50	7.00	5.50	20	M10
GTIN ER32 DIN 8.00X6.20	8.00	6.20	20	M8
GTIN ER32 DIN 9.00X7.00	9.00	7.00	20	M12
GTIN ER32 DIN 10.00X8.00	10.00	8.00	20	M10
GTIN ER32 DIN 11.00X9.00	11.00	9.00	20	M14
GTIN ER32 DIN 12.00X9.00	12.00	9.00	20	M16

Designation	d	S	T Wrench	Tap Size
GTIN ER32 JIS 3.0X2.5	3.0	2.5	20	M1-M2.6
GTIN ER32 JIS 4.0X3.2	4.0	3.2	20	M3-M3.5
GTIN ER32 JIS 5.0X4.0	5.0	4.0	20	M4
GTIN ER32 JIS 5.5X4.5	5.5	4.5	20	M5
GTIN ER32 JIS 6.0X4.5	6.0	4.5	20	M6
GTIN ER32 JIS 6.2X5.0	6.2	5.0	20	M8
GTIN ER32 JIS 7.0X5.5	7.0	5.5	20	M10
GTIN ER32 JIS 8.5X6.5	8.5	6.5	20	M12
GTIN ER32 JIS 10.5X8.0	10.5	8.0	20	M14
GTIN ER32 JIS 12.5X10.0	12.5	10.0	20	M16

No coolant should be induced through the tapping collet. It will cause malfunctioning of the mechanism.

ACCESSORIES - PULL STUD - CAT ANSI

58-60 HRc



Ra 4µin

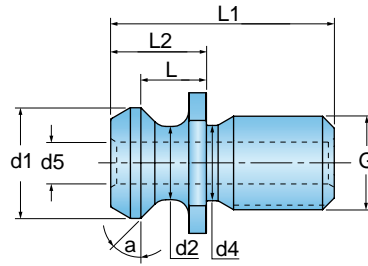

Designation	G	d1	d2	d4	d5	L	L1	L2	a°
PS CAT30 45° 1/2 ANSI	1/2-13	.520	.390	.385	-	.320	1.100	.460	45
PS CAT40 45° 5/8 ANSI	5/8-11	.740	.490	.490	-	.439	1.500	.640	45
PS CAT40 45° 5/8 ANSI B	5/8-11	.740	.490	.490	.280	.439	1.500	.640	45
PS CAT50 45° 1 ANSI	1-8	1.140	.820	.820	-	.703	2.300	1.000	45
PS CAT50 45° 1 ANSI B	1-8	1.140	.820	.820	.315	.703	2.300	1.000	45

"B" = with internal coolant

ACCESSORIES - PULL STUD - CAT MAS

58-60 HRc



Ra 4µin

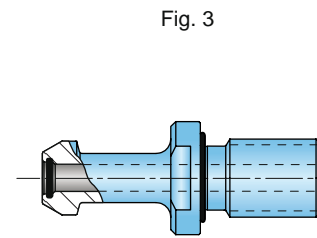
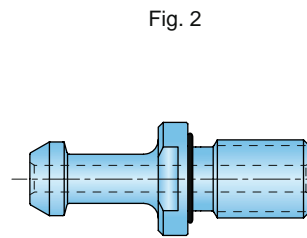
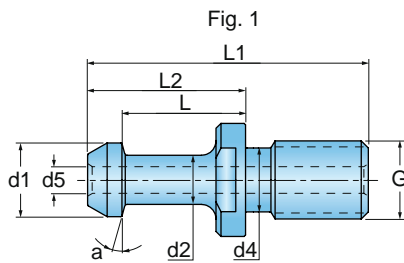
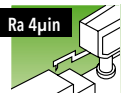

Designation	G	d1	d2	d4	d5	L	L1	L2	a°	Fig.
PS CAT40 45° 5/8 MAS1	5/8-11	.590	.390	.512	-	.990	2.250	1.266	45	1
PS CAT40 45° 5/8 MAS1 B	5/8-11	.590	.390	.512	.217	.990	2.250	1.266	45	1
PS CAT40 60° 5/8 MAS2	5/8-11	.590	.390	.512	-	.990	2.250	1.266	60	1
PS CAT40 60° 5/8 MAS2 B	5/8-11	.590	.390	.512	.217	.990	2.250	1.266	60	1
PS CAT40 90° 5/8 MAS3	5/8-11	.590	.390	.512	-	.990	2.250	1.266	90	1
PS CAT40 90° 5/8 MAS3 B	5/8-11	.590	.390	.512	.217	.990	2.250	1.266	90	1
PS CAT50 45° 1" MAS1	1-8	.906	.670	.827	-	1.378	3.346	1.772	45	1
PS CAT50 45° 1" MAS1 B	1-8	.906	.670	.827	.236	1.378	3.346	1.772	45	1
PS CAT50 45° 1" MAS1 O B	1-8	.906	.670	.827	.236	1.386	3.346	1.772	45	2
PS CAT50 45° 1" MAS1 O B O	1-8	.906	.670	.827	.236	1.386	3.346	1.772	45	3
PS CAT50 60° 1" MAS2	1-8	.906	.670	.827	-	1.378	3.346	1.772	60	1
PS CAT50 60° 1" MAS2 B	1-8	.906	.670	.827	.236	1.378	3.346	1.772	60	1
PS CAT50 90° 1" MAS3	1-8	.906	.670	.827	-	1.378	3.346	1.772	90	1
PS CAT50 90° 1" MAS3 B	1-8	.906	.670	.827	.236	1.378	3.346	1.772	90	1

ACCESSORIES - PULL STUD - OTT SYSTEM - METRIC

58-60 HRc

√ N5

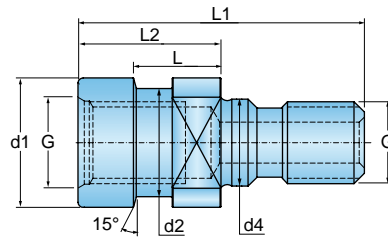

Designation	G	d1	d2	d4	L	L1	L2
PS OTT BT40 M16	M16	25.0	21.1	17	16.60	56	28
PS OTT SK40 M16	M16	25.0	21.1	17	13.60	53	25
PS OTT BT50 M24	M24	39.3	32.0	25	13.35	65	25

ACCESSORIES - PULL STUD - BT-MAS - METRIC

58-60 HRc

√ N5

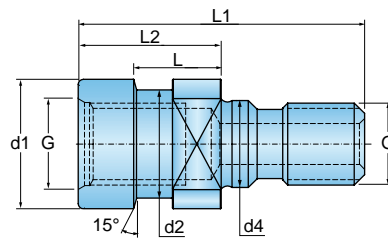

Designation	G	d1	d2	d4	d5	L	L1	L2	a°	Fig.
PS BT30 45° M12 MAS1	M12	11	7	12.5	-	18	43	23	45	1
PS BT30 45° M12 MAS1 B	M12	11	7	12.5	3	18	43	23	45	1
PS BT30 60° M12 MAS2	M12	11	7	12.5	-	18	43	23	30	1
PS BT30 60° M12 MAS2 B	M12	11	7	12.5	3	18	43	23	30	1
PS BT40 45° M16 MAS1	M16	15	10	17.0	-	28	60	35	45	1
PS BT40 45° M16 MAS1 B	M16	15	10	17.0	5.5	28	60	35	45	1
PS BT40 60° M16 MAS2	M16	15	10	17.0	-	28	60	35	30	1
PS BT40 60° M16 MAS2 B	M16	15	10	17.0	5.5	28	60	35	30	1
PS BT40 90° M16 MAS3	M16	15	10	17.0	-	28	60	35	90	1
PS BT40 90° M16 MAS3 B	M16	15	10	17.0	5.5	28	60	35	90	1
PS BT50 45° M24 MAS1	M24	23	17	25.0	-	35	85	45	45	1
PS BT50 45° M24 MAS1 B	M24	23	17	25.0	6.0	35	85	45	45	1
PS BT50 45° M24 MAS1 O B	M24	23	17	25.0	6.0	35	85	45	45	2
PS BT50 45° M24 MAS1 O B O	M24	23	17	25.0	6.0	35	85	45	45	3
PS BT50 60° M24 MAS2	M24	23	17	25.0	-	35	85	45	30	1
PS BT50 60° M24 MAS2 B	M24	23	17	25.0	6.0	35	85	45	30	1
PS BT50 60° M24 MAS2 O B	M24	23	17	25.0	6.0	35	85	45	30	2
PS BT50 90° M24 MAS3	M24	23	17	25.0	-	35	85	45	90	1
PS BT50 90° M24 MAS3 B	M24	23	17	25.0	6.0	35	85	45	90	1
PS BT50 90° M24 MAS3 O B	M24	23	17	25.0	6.0	35	85	45	90	2

"O" = O-Ring on dimension d4

"B" = internal coolant

ACCESSORIES - PULL STUD - BT-JIS/ANSI - METRIC

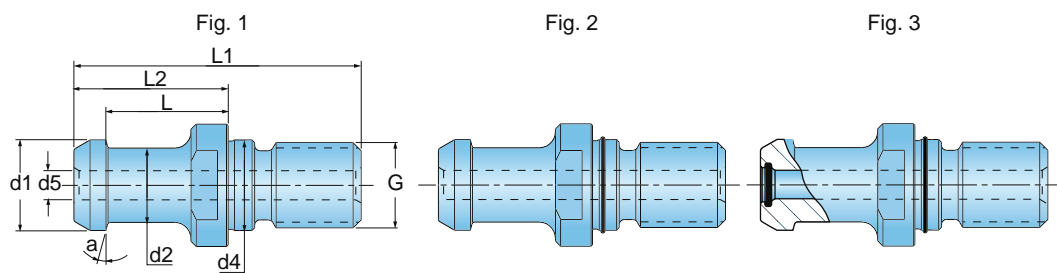

Designation	G	d1	d2	d4	d5	L	L1	L2	a°	Fig.
PS BT30 15° M12 JIS B	M12	12.00	8.0	13	4.0	18.4	43.0	23.4	15	1
PS BT40 15° M16 JIS B	M16	19.00	14.0	17	5.5	23	54.0	29.0	15	1
PS BT40 15° M16 JIS O B	M16	19.00	14.0	17	5.5	23	54.0	29.0	15	2
PS BT40 15° M16 JIS O B O	M16	19.00	14.0	17	5.5	23	54.0	29.0	15	3
PS BT50 15° M24 JIS B	M24	28.00	21.0	25	8.0	25	74.0	34.0	15	1
PS BT50 15° M24 JIS O B	M24	28.00	21.0	25	8.0	25	74.0	34.0	15	2
PS BT50 15° M24 JIS O B O	M24	28.00	21.0	25	8.0	25	74.0	34.0	15	3
PS BT40 45° M16 MAZAK B	M16	18.79	12.4	17	7.0	14.026	44.1	19.1	45	1
PS BT50 45° M24 MAZAK B	M24	28.95	20.8	25	8.0	17.58	65.2	25.2	45	1

ACCESSORIES - PULL STUD - DIN69872/ISO 7388 - METRIC

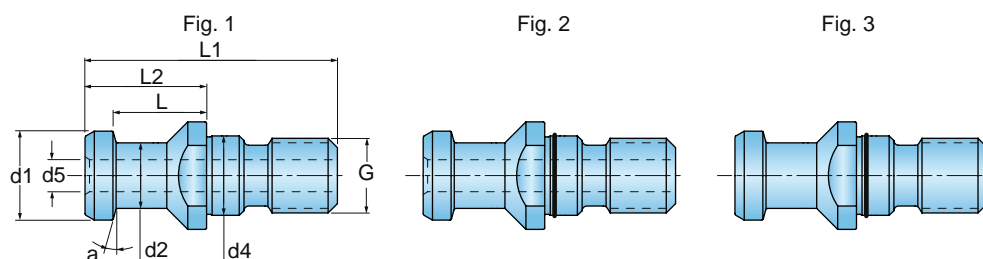

Designation	G	d1	d2	d4	d5	L	L1	L2	a°	Fig.
PS SK30 15° M12 DIN	M12	13	9	13	-	19	44	24	15	1
PS SK40 15° M16 DIN	M16	19	14	17	-	20	54	26	15	1
PS SK40 15° M16 DIN O	M16	19	14	17	-	20	54	26	15	3
PS SK40 15° M16 DIN B	M16	19	14	17	7.0	20	54	26	15	1
PS SK40 15° M16 DIN O B	M16	19	14	17	7.0	20	54	26	15	2
PS SK50 15° M24 DIN	M24	28	21	25	-	25	74	34	15	1
PS SK50 15° M24 DIN O	M24	28	21	25	-	25	74	34	15	3
PS SK50 15° M24 DIN B	M24	28	21	25	11.5	25	74	34	15	1
PS CAT30 45° M12 ISO B	M12	13.35	9.3	13	4.75	8.13	34.0	11.80	45	1
PS CAT40 45° M16 ISO B	M16	18.95	12.9	17	7.35	11.15	44.5	16.40	45	1
PS CAT50 45° M24 ISO B	M24	29.10	19.6	25	8	17.95	65.5	25.55	45	1

"O" = O-Ring on dimension d4

"B" = internal coolant

ACCESSORIES - ER CLAMPING NUT DIN 6499 - METRIC

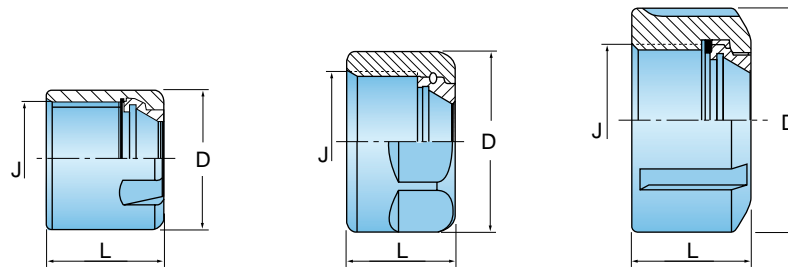

Designation	D	L	J	Kg•m	Lb•in
NUT ER16 TOP MINI	22	18	M19X1.0	4	347
NUT ER16 TOP	28	17	M22X1.5	7	608
NUT ER20 TOP	34	19	M25X1.5	12	1042
NUT ER25 TOP	42	20	M32X1.5	20	1736
NUT ER32 TOP	50	22	M40X1.5	22	1910
NUT ER40 TOP	63	25	M50X1.5	25	2170

ACCESSORIES - ER -UM & MINI CLAMPING NUT DIN 6499 - METRIC

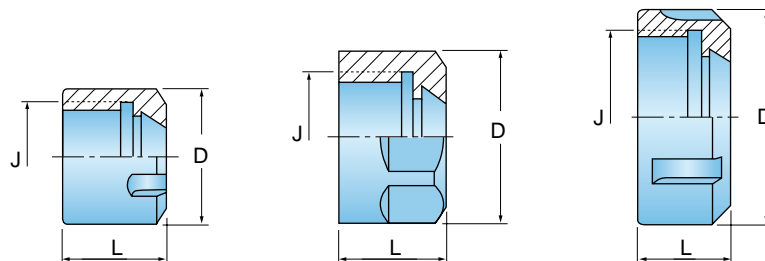

Designation	D	L	J	Kg•m	Lb•in
NUT ER11 MINI	16	10.8	M13X0.75	3	260
NUT ER11 UM	19	11.3	M14X0.75	5	434
NUT ER16 MINI	22	18.0	M19X1.0	4	347
NUT ER16 UM	28	17.0	M22X1.5	7	608
NUT ER20 MINI	28	19.0	M24X1.0	8	694
NUT ER20 UM	34	19.0	M25X1.5	12	1042
NUT ER25 MINI	35	20.0	M30X1.0	10	868
NUT ER25 UM	42	20.0	M32X1.5	20	1736
NUT ER32 UM	50	22.0	M40X1.5	22	1910
NUT ER40 UM	63	25.0	M50X1.5	25	2170
NUT ER50 UM	78	35.0	M64X2.0	35	3038

ACCESSORIES - NUT E32 SHORTIN - METRIC

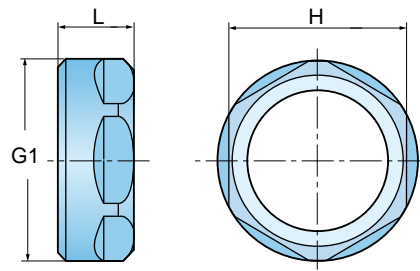

Designation	H	L	G1	Kgxm
NUT ER20 SHORT	22	10.7	M25X1.5	12
NUT ER32 SHORT	36	15.0	M40X1.5	22
NUT ER40 SHORT	46	16.0	M50X1.5	25

ACCESSORIES - WRENCH FOR ER DIN 6499 - METRIC

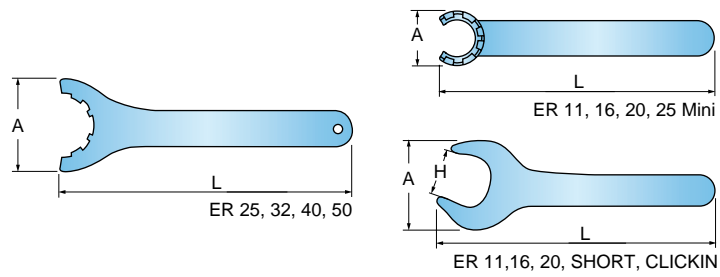

Designation	A	H	L
WRENCH ER11 MINI	16.8	--	95
WRENCH ER11	32	17	95
WRENCH ER16 MINI	22.5	--	117
WRENCH ER16	42	25	143
WRENCH ER20 MINI	28	--	128
WRENCH ER20	54	30	172
WRENCH ER25 MINI	36	--	130
WRENCH ER25	70	--	207
WRENCH ER32	78	--	255
WRENCH ER40	95	--	285
WRENCH ER50	110	--	350
WRENCH ER20 SHORT	48	22	260
WRENCH ER32 SHORT	36	74	303
WRENCH ER40 SHORT	46	93	378

ACCESSORIES - STANDARD PRESET SCREW FOR ER COLLET CHUCK

Fig. 1

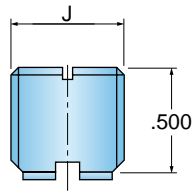

Designation	J	Fig.
PRESET SCREW (Inch)		
PRESET TG100 1-1/8x16 L.H.	UNC 1-1/8x16 L.H.	1

ACCESSORIES - PRESET SCREW WITH COOLANT HOLE FOR ER COOLIT SEALED COLLETS - METRIC

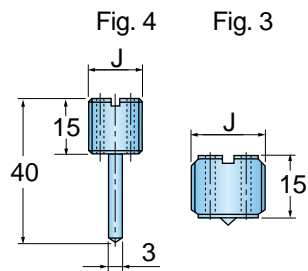

Designation	J	Fig.
PRESET ER-JET 8X1.0	M8X1.0	3
PRESET ER-JET 8X1.25	M8X1.25	3
PRESET ER-JET 10X1.5	M10X1.5	3
PRESET ER-JET 12X1.0	M12X1.0	3
PRESET ER-JET 12X1.75L	M12X1.75	4
PRESET ER-JET 12X1.75	M12X1.75	3
PRESET ER-JET 14X1.0	M14X1.0	3
PRESET ER-JET 16X2	M16X2	3
PRESET ER-JET 16X2L	M16X2	4
PRESET ER-JET 18X1.0	M18X1.0	3
PRESET ER-JET 18X1.5	M18X1.5	3
PRESET ER-JET 18X1.5L	M18X1.5	4
PRESET ER-JET 22X1.5	M22X1.5	3
PRESET ER-JET 22X1.5L	M22X1.5	4
PRESET ER-JET 28X1.5	M28X1.5	3

ACCESSORIES - LOCK SCREW FOR SHELL MILL HOLDER

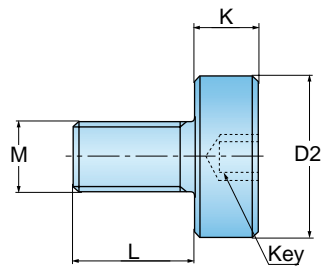

Designation	Shell Mill	M	D2	key	K	L
SCREW 1/4-28 SEM 1/2	1/2	1/4-28	.656	.250	.312	.719
SCREW 3/8-24 SEM 3/4	3/4	3/8-24	.890	.312	.390	.719
SCREW 1/2-20 SEM 1	1	1/2-20	1.187	.312	.484	.719
SCREW 5/8-18 SEM 1-1/4	1-1/4	5/8-18	1.500	.312	.516	.875
SCREW 3/4-16 SEM 1-1/2	1-1/2	3/4-16	1.875	.500	.516	.937
SCREW 1-14 SEM 2	2	1-14	2.484	.500	.516	.937
SCREW 1-14 SEM 2-1/2	2-1/2	1-14	3.125	.500	.516	1.375

ACCESSORIES - LOCK SCREW FOR SHELL MILL HOLDER - METRIC

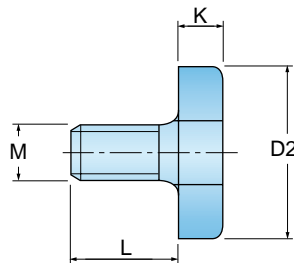

Designation	Shell Mill	M	D2	K	L
M 8 CLAMP SCREW SEM 16	16	M8	20	6	16
M 10 CLAMP SCREW SEM 22	22	M10	28	7	18
M 12 CLAMP SCREW SEM 27	27	M12	35	8	22
M 16 CLAMP SCREW SEM 32	32	M16	42	9	26
M 20 CLAMP SCREW SEM 40	40	M20	52	10	30
M 24 CLAMP SCREW SEM 50	50	M24	63	12	36

ACCESSORIES - LOCK SCREW FOR END MILL HOLDER

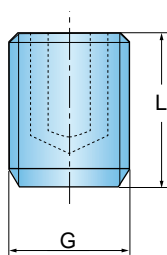

Designation	G	L	Used for Shanks
SCREW 1/4-28x.313 EM	1/4-28	.313	3/16, 1/4
SCREW 3/8-24x.4375 EM	3/8-24	.438	3/8
SCREW 7/16-20x.438 EM	7/16-20	.438	1/2
SCREW 1/2-20x.500 EM	1/2-20	.500	5/8
SCREW 5/8-18x.500 EM	5/8-18	.500	3/4, 7/8
SCREW 3/4-16x.625 EM	3/4-16	.625	1, 1-1/4, 1-1/2
SCREW 1-1/4x7/8 EM	1-14	.875	2
SCREW 1-1/4x1.250 EM	1-14	1.250	2-1/2

ACCESSORIES - PRESET SCREW FOR SRKIN THERMAL SHRINK COLLETS - METRIC

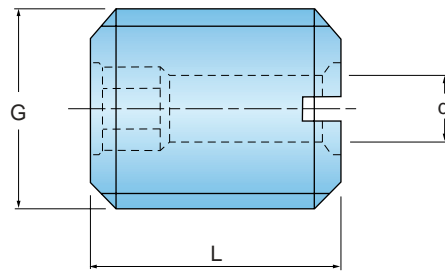

Designation	G	L	d	Used for Shanks	Hex key
PRESET SCREW M 5X20 B	M 5X0.8	20	2.1	EM E / SRKIN	2.5
PRESET SCREW M 6X20 B	M 6X1	20	2.5	EM E / SRKIN	3.0
PRESET SCREW M 8X20 B	M 8X1.25	20	3.5	EM E / SRKIN	4.0
PRESET SCREW M10X18 B	M 10X1.5	18	4.5	EM E / SRKIN	5.0
PRESET SCREW M12X18 B	M 12X1.75	18	5.5	EM E / SRKIN	6.0
PRESET SCREW M16X20 B	M 16X2	20	7.5	EM E / SRKIN	8.0
PRESET SCREW M16X25 B	M 16X2	25	7.5	SRKIN	8.0
PRESET SCREW M20X20 B	M 20X2.5	20	6.0	EM E	6.0
PRESET SCREW M20X25 B	M 20X2	25	9.5	EM E	10.0

ACCESSORIES - HSK COOLING TUBE - METRIC

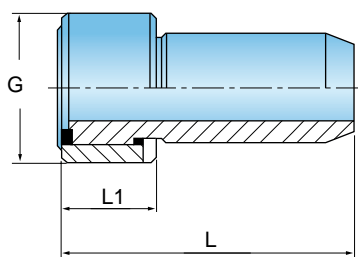

Designation	HSK-A	L	L1	G
COOLING TUBE HSK A 40	40	29.1	7.5	M12X1
COOLING TUBE HSK A 50	50	32.7	9.5	M16X1
COOLING TUBE HSK A 63	63	36.0	11.5	M18X1
COOLING TUBE HSK A 80	80	36.6	13.5	M20X1.5
COOLING TUBE HSK A 100	100	43.6	15.5	M24X1.5

ACCESSORIES - WRENCH FOR HSK COOLING TUBE - METRIC

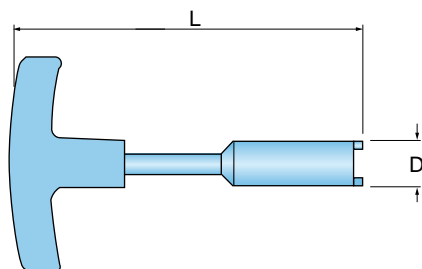

Designation	HSK-A	D	L
WRENCH COOL TUBE HSK 40	40	11.0	120
WRENCH COOL TUBE HSK 50	50	15.0	120
WRENCH COOL TUBE HSK 63	63	17.0	122
WRENCH COOL TUBE HSK 80	80	18.5	186
WRENCH COOL TUBE HSK100	100	22.0	141

ACCESSORIES - TOOL CLAMP FIXTURE FIXTURE FOR ISO, DIN 69871 AND BT MAS-403 TOOL SHANK

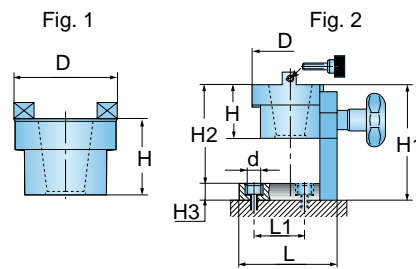

Designation	D	H	H1	H2	H3	L	L1	d	figure
TOOL CLAMP 30 ROTARY	2.76	2.20	5.00	4.30	.75	4.10	1.57	.49	2
TOOL CLAMP 40 ROTARY	3.23	2.20	5.00	4.30	.75	4.10	1.57	.49	2
TOOL CLAMP 50 ROTARY	4.06	2.80	6.70	5.95	.75	5.67	3.35	.49	2
TOOL CLAMP 30 FIX	3.23	2.28							1
TOOL CLAMP 40 FIX	3.23	2.28							1
TOOL CLAMP 50 FIX	4.06	2.80							1

ACCESSORIES - MULTI CLAMP HSK E/F ROTARY FIXTURE FOR HSK-E/F TYPE SHANK

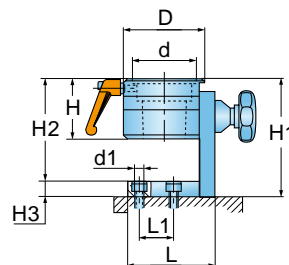

Designation	D	d	d1	L	L1	H	H1	H2	H3
MULTI CLAMP 50 A/C	3.23	1.97	.49	4.09	1.57	2.83	5.59	4.84	.75
MULTI CLAMP 63 A/C	3.74	2.48	.49	4.09	1.57	2.83	5.59	4.84	.75
MULTI CLAMP 100 A/C	5.12	3.94	.49	5.67	3.35	3.54	7.00	6.26	.75

ACCESSORIES - MULTI CLAMP HSK A/C ROTARY FIXTURE FOR HSK-A/C TYPE SHANK

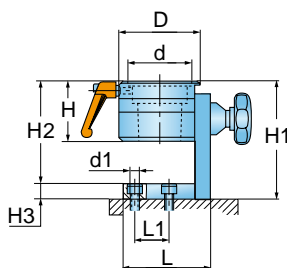

Designation	D	d	d1	L	L1	H	H1	H2	H3
MULTI CLAMP 40 E/F	2.89	1.57	.49	4.09	1.57	2.17	4.92	4.17	.75
MULTI CLAMP 50 E/F	2.89	1.97	.49	4.09	1.57	2.17	4.92	4.17	.75
MULTI CLAMP 63 E/F	4.20	2.48	.49	5.67	3.35	2.76	4.50	3.75	.75

EASYLOCK - ELECTRICAL NUT-CLAMP TORQUE CONTROL DEVICE

- Ensures controlled clamping of cutting tools
- Maintains collet chuck accuracy
- Easy clamping and unclamping of cutting tools
- Handy set for various collet chuck sizes
- Main spindle taper #50
- Suitable for main shank standards #30, #40, #50, HSK 63, HSK 100

Table Model

Specifications

Power Supply:	3 phase 440/460 50/60 HZ
Weight:	Table model - 190 lbs. Trolley (optional) - 33 lbs.

EasyLock Unit/Trolley

Designation

EasyLock T.C. USA
EasyLock Trolley

Accessories:

Standard

TP50 AD 40 Easy
Wrench ER16 EasyLock
Wrench ER20 EasyLock
Wrench ER25 EasyLock
Wrench ER32 EasyLock
Wrench ER40 EasyLock
Wrench TG100 Open Easy

Optional:

TP40 AD 30 Easy
TP50 AD HSK 63 EasyLock
TP50 AD HSK 100 Easy
Wrench ER50 EasyLock

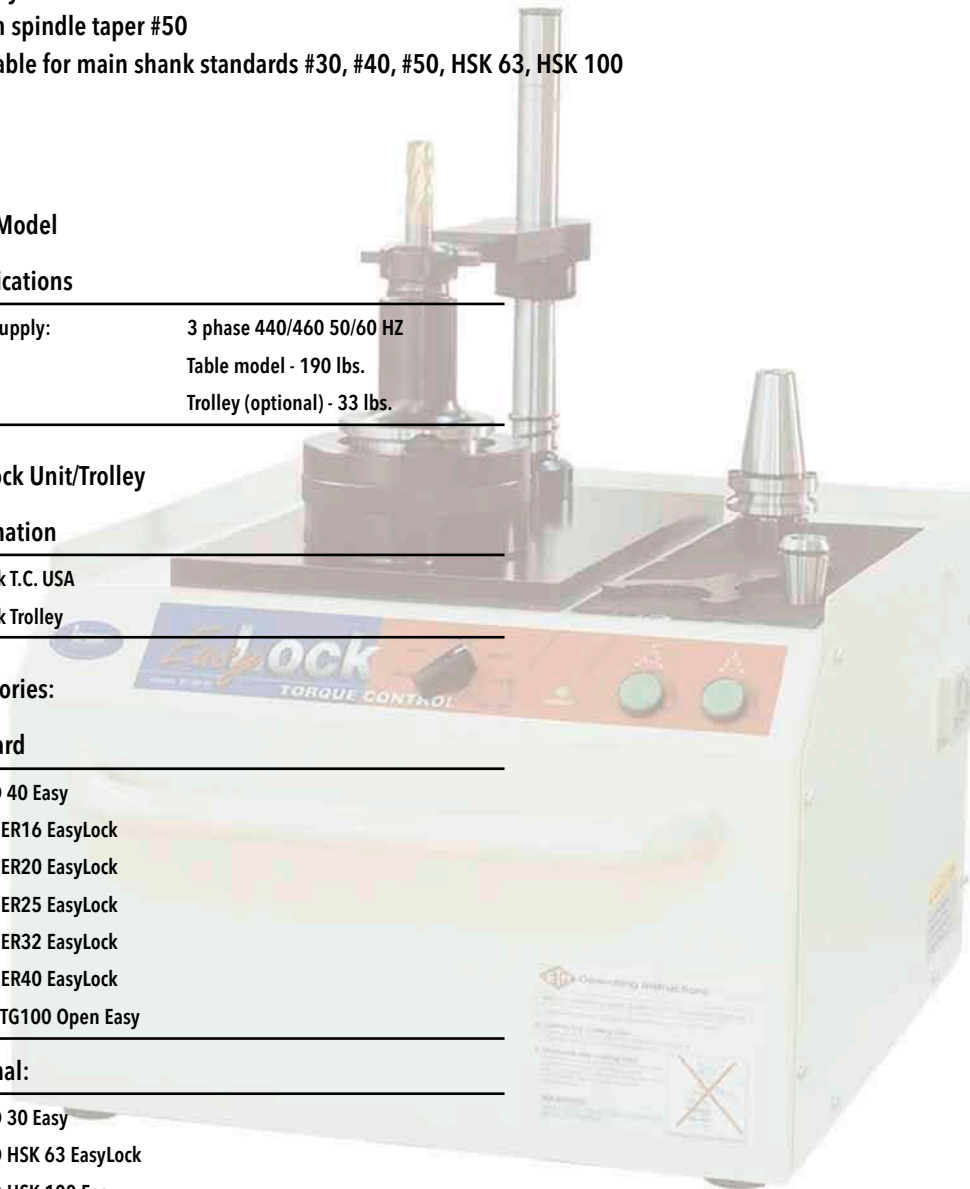

EASYLOCK - ELECTRICAL NUT-CLAMP TORQUE CONTROL DEVICE

Power Clamping Unit for Collet Chucks

1. Assemble the collet and cutting tool. By hand, place the nut onto the collet chuck.

2. Mount the collet chuck into the unit spindle.

3. Choose the correct wrench size. Mount it on the wrench holder.

4. Place the wrench on the collet chuck nut.

Power Lamp

5. Ensure that main power switch is on and that the power supply cable is connected.

6. To Unclamp - Push and hold in the unclamp button until the collet chuck is totally open.

6. To Clamp - Push and hold in the clamp button until the bottom light goes off.

7. Torque Selector

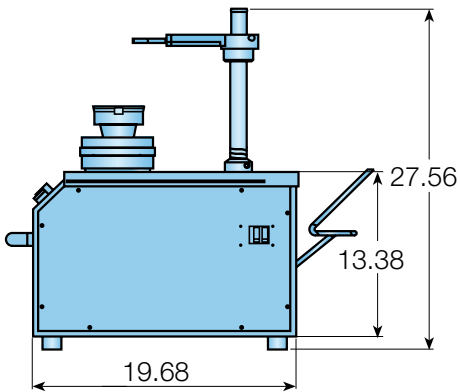
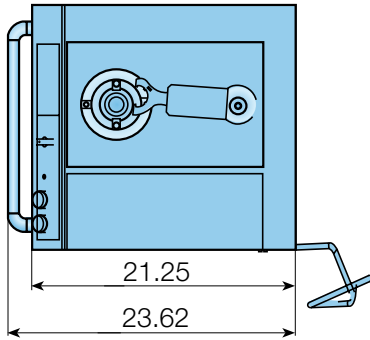

Trolley (Optional)

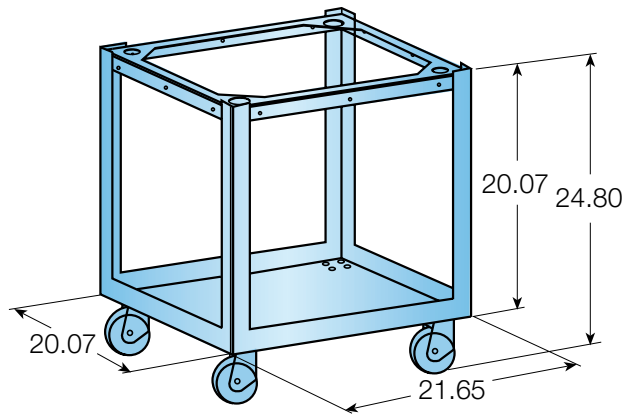



Ingersoll
Member of the Group
Cutting Tools

TIGNR
2525 M16
S114 (S113)
S114 S187W (50 35000)

30916

Ingersoll
Member of the Group
Cutting Tools

TQTER 25.4-4-4-20

Ingersoll
Member of the Group
Cutting Tools

TTR 25-40-4

Inaersoll

INNO-FIT & TOP-ON TOOLHOLDERS

HSK TOOLHOLDERS

CAT TOOLHOLDERS

BT TOOLHOLDERS

SPECIAL ADAPTIONS & ACCESSORIES

TURNING

THREADING

T-CLAMP

T-CAP

Ingersoll



■ DESIGNATION SYSTEM	PAGE 876
■ INSERT INDEX.....	PAGE 878
NEGATIVE INSERTS	PAGE 894
POSITIVE INSERTS	PAGE 961
INSERTS FOR ALUMINUM	PAGE 990
CERAMIC INSERTS	PAGE 994
CBN INSERTS	PAGE 1008
PCD INSERTS.....	PAGE 1018
■ EXTERNAL & INTERNAL TOOLHOLDERS	
DESIGNATION SYSTEM FOR EXTERNAL TOOLHOLDERS	PAGE 1024
DESIGNATION SYSTEM FOR BORING BARS	PAGE 1028
■ TOOLHOLDER INDEX	PAGE 1032
TOP CLAMP EXTERNAL TURNING TOOLHOLDERS.....	PAGE 1042
MULTI LOCK EXTERNAL TURNING TOOLHOLDERS.....	PAGE 1049
SCREW HELD EXTERNAL TURNING TOOLHOLDERS	PAGE 1064
T-TYPE EXTERNAL TURNING TOOLHOLDERS	PAGE 1084
TOP CLAMP EXTERNAL TURNING TOOLHOLDERS FOR CERAMIC INSERTS	PAGE 1103
T-TYPE EXTERNAL TURNING TOOLHOLDERS FOR CERAMIC DIMPLE INSERTS.....	PAGE 1111
TOP CLAMP INTERNAL TURNING TOOL HOLDERS	PAGE 1114
MULTI-LOCK INTERNAL TURNING TOOL HOLDERS	PAGE 1116
LEVER LOCK INTERNAL TURNING TOOL HOLDERS	PAGE 1123
SCREW HELD INTERNAL TURNING TOOL HOLDERS	PAGE 1125
T-TYPE INTERNAL TURNING TOOL HOLDERS	PAGE 1137
T-TYPE INTERNAL TURNING TOOL HOLDERS FOR CERAMIC DIMPLE INSERTS.....	PAGE 1141

TURNING

Cutting Tools

■ GRADES - CARBIDE & CERMET.....	PAGE 1148
■ CHIPBREAKERS.....	PAGE 1151
■ TROUBLE SHOOTING	PAGE 1158
■ TECHNICAL INFORMATION	
CERAMIC INSERTS	PAGE 1160
CBN INSERTS	PAGE 1164
PCD INSERTS.....	PAGE 1166
■ CROSSOVER INFORMATION.....	PAGE 1167

GENERAL TECHNICAL INFORMATION

TOTURN™ TURNING INSERT DESIGNATION SYSTEM

1 SHAPE		
C	D	E
H	K	R
S	T	V
W		

2 CLEARANCE ANGLE	
N	B
C	P

4 TYPE		
A	G	M
R	B, W	T.H
Special Z, X		

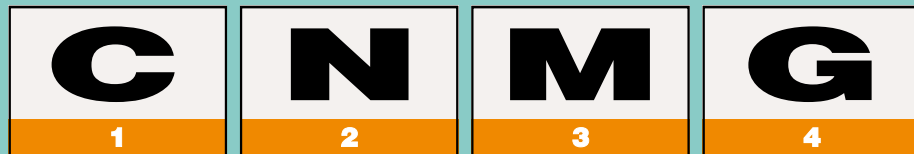

3 TOLERANCE

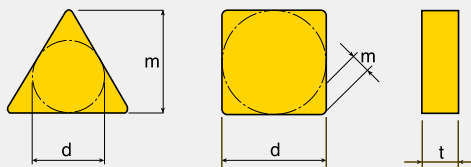

Class	m	t	d
A	±0.0002	±0.001	±0.001
F	±0.0002	±0.001	±0.0005
C	±0.0005	±0.001	±0.001
H	±0.0005	±0.001	±0.0005
E	±0.001	±0.001	±0.001
G	±0.001	±0.005	±0.001
M	±0.003 - ±0.007	±0.005	±0.002 - ±0.005
U	±0.005 - ±0.015	±0.005	±0.003 - ±0.010

Diameter of IC	Tolerance			
	On m		On d	
	Class M	Class U	Class M	Class U
.250	±0.003	±0.005	±0.002	±0.003
.375	±0.003	±0.005	±0.002	±0.003
.500	±0.005	±0.008	±0.003	±0.005
.625	±0.006	±0.011	±0.004	±0.007
.750	±0.006	±0.011	±0.004	±0.007
1.000	±0.007	±0.015	±0.005	±0.010
1.250	±0.007	±0.015	±0.005	±0.010

GENERAL TECHNICAL INFORMATION

TOTURN™ TURNING INSERT DESIGNATION SYSTEM

6 THICKNESS

ANSI	ISO	VALUE
1	01	0.063
-	T1	0.078
1.5	02	0.094
-	T2	0.109
2	03	0.125
2.5	T3	0.156
3	04	0.187
-	05	0.219
4	06	0.250
5	07	0.313
6	09	0.375

7 CORNER RADIUS

SYMBOL		DIMENSIONS	
ANSI	ISO	inch	mm
0	00	0-.005	0-.127
0.5	02	.008	0.2
1	04	.016	0.4
-	05	.020	0.5
2	08	.031	0.8
3	12	.047	1.2
4	16	.063	1.6
5	20	.079	2.0
6	24	.094	2.4
8	32	.125	3.2

8 HAND OF INSERT

R Right Hand

L Left Hand

9 CHIPBREAKER DESIGNATION

WS	Wiper, super finishing
FA	Finishing accurate
FG	General finishing
EA	Finishing, exotic materials
SF	Finishing, stainless steel
MP	Medium popular
VF	Medium popular
GU	Medium roughing
PC	Medium popular
MT	Medium roughing
SU	Medium, exotic materials
WT	Wiper, medium roughing
ET	Roughing, exotic materials
RT	Roughing, tough rake angle
RH	Roughing high feed
HT	Roughing high feed

4
12
5

3
04
6

2
08
7

(R)
8

MP
9









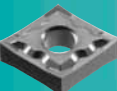

see page 877 for all chip breakers













5 CUTTING EDGE LENGTH

I.C.				C	D	E	R	S	T	V	W	K	H
ANSI SYMBOL	ISO SYMBOL	inch	mm										
1.2 (5)*		0.156	3.97	03	04			03	06		02		
1.5 (6)*		0.188	4.76	04	05			04	08	08			
1.8 (7)*		0.219	5.56	05				05	09	09	03		
2		0.250	6.35	06	07			06	11	11	04		
2.5		0.313	7.94	08	09			07	13	13	05		
	08		8.00				08						
3		0.375	9.52	09	11		09	09	16	16	06	16	
	10		10.00				10						
	12		12.00				12						
4		0.500	12.70	12	15	13		12	22	22	08		05
5		0.625	15.88	16	19		15	15	27	27	10		
	16		16.00				16						
6		0.750	19.05	19	23		19	19	33	33	13		10
	20		20.00				20						
	25		25.00				25						
8		1.000	25.40	25	31		25	25	44	44	17		
10		1.250	31.75	32	38		31	31	54	54	21		
	32		32.00				32						

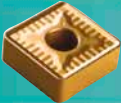

*As measured in 1/32" increments

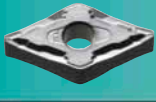









TURNING

Carbide	Insert	Description	Page
	TOTURN CNMA	Negative 80° rhombic flat top inserts for roughing	894
	TOTURN CNGG ML CHIPBREAKER	Negative 80° rhombic ground inserts for medium light machining / very positive break angle	894
	TOTURN CNMG COMMON CHIPBREAKER	Negative 80° rhombic inserts for medium roughing	996
	TOTURN CNMG EA CHIPBREAKER	Negative 80° rhombic inserts for semi-finish to finishing	896
	TOTURN CNMG ET CHIPBREAKER	Negative 80° rhombic inserts for medium to rough machining	897
	TOTURN CNMG FA CHIPBREAKER	Negative 80° rhombic inserts for super finishing	898
	TOTURN CNMG FC CHIPBREAKER	Negative 80° rhombic inserts for finishing	898
	TOTURN CNMG FG CHIPBREAKER	Negative 80° rhombic inserts for finishing	899
	TOTURN CNMG MC CHIPBREAKER	Negative 80° rhombic inserts for medium machining / negative rake angle	899
	TOTURN CNMG ML CHIPBREAKER	Negative 80° rhombic inserts for medium light machining / very positive rake angle	900
	TOTURN CNMG MP CHIPBREAKER	Negative 80° rhombic inserts for medium machining / positive rake angle	901
	TOTURN CNMG MT CHIPBREAKER	Negative 80° rhombic inserts for medium roughing / tough rake angle	902













Carbide	Insert	Description	Page
	TOTURN CNMG PC CHIPBREAKER	Negative 80° rhombic inserts for medium machining	903
	TOTURN CNMG RT CHIPBREAKER	Negative 80° rhombic inserts for roughing / wide, tough rake angle	904
	TOTURN CNMG SF CHIPBREAKER	Negative 80° rhombic inserts for semi-finishing to finishing	905
	TOTURN CNMG WS CHIPBREAKER	Negative 80° rhombic wiper inserts for super finishing	905
	TOTURN CNMG WT CHIPBREAKER	Negative 80° rhombic wiper inserts for medium roughing	906
	TOTURN CNMM HT CHIPBREAKER	Negative 80° rhombic inserts for heavy turning applications	906
	TOTURN CNMM HY CHIPBREAKER	Negative 80° rhombic inserts for heavy roughing	907
	TOTURN CNMM HZ CHIPBREAKER	Negative 80° rhombic inserts for heavy roughing	907
	TOTURN CNMM RH CHIPBREAKER	Negative 80° rhombic inserts for high feed roughing	908
	TOTURN CNMM RH(N) CHIPBREAKER	Negative 80° rhombic inserts for high feed roughing	908
	TOTURN DNGG ML CHIPBREAKER	Negative 55° rhombic ground inserts for medium light machining / very sharp	909
	TOTURN DNMA	Negative 55° rhombic flat top insert for roughing	909

TURNING

Carbide	Insert	Description	Page
	TOTURN DNMG COMMON CHIPBREAKER	Negative 55° rhombic inserts for medium roughing	910
	TOTURN DNMG FA CHIPBREAKER	Negative 55° rhombic inserts for super finishing	911
	TOTURN DNMG FC CHIPBREAKER	Negative 55° rhombic inserts for finishing	911
	TOTURN DNMG FG CHIPBREAKER	Negative 55° rhombic inserts for finishing	912
	TOTURN DNMG MC CHIPBREAKER	Negative 55° rhombic inserts for medium machining / negative rake angle	913
	TOTURN DNMG ML CHIPBREAKER	Negative 55° rhombic inserts for medium light machining / very positive rake angle	913
	TOTURN DNMG MP CHIPBREAKER	Negative 55° rhombic inserts for medium machining / positive rake angle	914
	TOTURN DNMG MT CHIPBREAKER	Negative 55° rhombic inserts for medium roughing / tough rake angle	915
	TOTURN DNMG PC CHIPBREAKER	Negative 55° rhombic inserts for medium machining	916
	TOTURN DNMG RT CHIPBREAKER	Negative 55° rhombic inserts for roughing / wide, tough rake angle	917
	TOTURN DNMG R/L-VF CHIPBREAKER	Negative 55° rhombic inserts for vibration free machining / low cutting force	918
	TOTURN DNMG WT	Negative 55° rhombic wiper inserts for medium roughing	919



Carbide	Insert	Description	Page
	TOTURN HNMG GU CHIPBREAKER	Negative 120° hexagonal inserts for medium roughing / tough rake angle	919
	TOTURN HNMG SU CHIPBREAKER	Negative 120° hexagonal inserts for medium machining / positive rake angle	920
	TOTURN KNUX R/L 11 CHIPBREAKER	Negative 55° rhombic inserts for medium machining in profiling	920
	TOTURN KNUX R/L 12 CHIPBREAKER	Negative 55° rhombic inserts for medium roughing in profiling	921
	TOTURN RNMG COMMON CHIPBREAKER	Negative round inserts for medium roughing	921
	TOTURN SNGG R/L CHIPBREAKER	Negative square ground inserts for medium light machining	922
	TOTURN SNMA	Negative square flat top inserts for roughing	922
	TOTURN SNMG COMMON CHIPBREAKER	Negative square inserts for medium roughing	923
	TOTURN SNMG FG CHIPBREAKER	Negative square inserts for finishing	924
	TOTURN SNMG MC CHIPBREAKER	Negative square inserts for medium machining / negative rake angle	924
	TOTURN SNMG ML CHIPBREAKER	Negative square inserts for medium light machining / very positive rake angle	925
	TOTURN SNMG MP CHIPBREAKER	Negative square inserts for medium machining / positive rake angle	925













TURNING

Carbide	Insert	Description	Page
	TOTURN SNMG MT CHIPBREAKER	Negative square inserts for medium roughing / tough rake angle	926
	TOTURN SNMG PC CHIPBREAKER	Negative square inserts for medium machining	927
	TOTURN SNMG RT CHIPBREAKER	Negative square inserts for roughing wide, tough rake angle	928
	TOTURN SNMM HT CHIPBREAKER	Negative square inserts for heavy roughing	929
	TOTURN SNMM HY CHIPBREAKER	Negative square inserts for heavy roughing	929
	TOTURN SNMM HZ CHIPBREAKER	Negative square inserts for heavy roughing	930
	TOTURN SNMM RH(N) CHIPBREAKER	Negative square inserts for high feed roughing	931
	TOTURN SNMM RH CHIPBREAKER	Negative square inserts for high feed roughing	931
	TOTURN TNGG R/L CHIPBREAKER	Negative triangular ground inserts for medium light machining	932
	TOTURN TNMA	Negative triangular flat top inserts for roughing	933
	TOTURN TNMG COMMON CHIPBREAKER	Negative triangular inserts for medium roughing	934
	TOTURN TNMG FC CHIPBREAKER	Negative triangular inserts for finishing	935









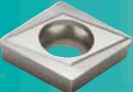

Carbide	Insert	Description	Page
	TOTURN™ TNMG FG CHIPBREAKER	Negative triangular inserts for finishing	936
	TOTURN™ TNMG R/L-FS CHIPBREAKER	Negative triangular inserts for semi-finishing	937
	TOTURN™ TNMG MC CHIPBREAKER	Negative triangular inserts for medium machining / negative rake angle	937
	TOTURN™ TNMG ML CHIPBREAKER	Negative triangular inserts for light machining / very positive rake angle	938
	TOTURN™ TNMG MP CHIPBREAKER	Negative triangular inserts for medium machining / positive rake angle	939
	TOTURN™ TNMG MT CHIPBREAKER	Negative triangular inserts for medium roughing / tough rake angle	940
	TOTURN™ TNMG PC CHIPBREAKER	Negative triangular inserts for medium machining	941
	TOTURN™ TNMG RT CHIPBREAKER	Triangular inserts for roughing wide / tough rake angle	942
	TOTURN™ TNMG SF CHIPBREAKER	Negative triangular inserts for semi-finishing to finishing	943
	TOTURN™ TNMG R/L-VF CHIPBREAKER	Negative triangular inserts for vibration free machining with very low cutting force	943
	TOTURN™ TNMM RH CHIPBREAKER	Negative triangular inserts for high feed roughing	944
	TOTURN™ VNGG ML CHIPBREAKER	Negative 35° rhombic ground inserts for medium light machining / very sharp	944

TURNING

Carbide	Insert	Description	Page
	TOTURN VNMG COMMON CHIPBREAKER	Negative 35° rhombic inserts for medium roughing	945
	TOTURN VNMG FA CHIPBREAKER	Negative 35° rhombic inserts for super finishing	946
	TOTURN VNMG FC CHIPBREAKER	Negative 35° rhombic inserts for finishing	946
	TOTURN VNMG FG CHIPBREAKER	Negative 35° rhombic inserts for finishing	947
	TOTURN VNMG MT CHIPBREAKER	Negative 35° rhombic inserts for medium roughing / tough rake angle	948
	TOTURN VNMG PC CHIPBREAKER	Negative 35° rhombic inserts for medium roughing	948
	TOTURN VNMM ML CHIPBREAKER	Negative 35° rhombic inserts for medium light machining / very sharp	949
	TOTURN WNMA	Negative 80° Trigon flat top inserts for roughing	950
	TOTURN WNMG ET CHIPBREAKER	Negative 80° trigon inserts for medium to rough machining	951
	TOTURN WNMG FC CHIPBREAKER	80° trigon inserts for finishing	952
	TOTURN WNMG FG CHIPBREAKER	80° trigon inserts for finishing	953
	TOTURN WNMG MC CHIPBREAKER	Negative 80° Trigon inserts for medium machining / negative rake angle	954

Carbide	Insert	Description	Page
	TOTURN WNMG ML CHIPBREAKER	Negative 80° Trigon inserts for medium light machining / very positive rake angle	955
	TOTURN WNMG MP CHIPBREAKER	Negative 80° trigon inserts for medium machining / positive rake angle	956
	TOTURN WNMG MT CHIPBREAKER	Negative 80° trigon inserts for medium roughing / tough rake angle	957
	TOTURN WNMG PC CHIPBREAKER	Negative 80° trigon inserts for medium machining	958
	TOTURN WNMG RT CHIPBREAKER	Negative 80° trigon inserts for roughing / wide, tough rake angle	959
	TOTURN WNMG WS CHIPBREAKER	Negative 80° trigon wiper inserts for super finishing	960
	TOTURN WNMG WT CHIPBREAKER	Negative 80° trigon wiper inserts for medium roughing	960
	TOTURN CCET R/L GF CHIPBREAKER	Positive 7° clearance 80° rhombic ground inserts for small parts	961
	TOTURN CCET R/L GW CHIPBREAKER	Positive 7° clearance 80° rhombic ground inserts with wiper geometry for small parts	961
	TOTURN CCMT FA CHIPBREAKER	Positive 7° clearance 80° rhombic inserts for super finishing	962
	TOTURN CCMT FG CHIPBREAKER	Positive 7° clearance 80° rhombic inserts for finishing	963
	TOTURN CCMT MT CHIPBREAKER	Positive 7° clearance 80° rhombic inserts for medium machining	964







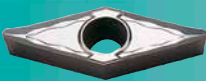

TURNING

Carbide	Insert	Description	Page
	TOTURN CCMT WT CHIPBREAKER	Positive 7° clearance 80° rhombic wiper inserts for finishing or higher feed rates	965
	TOTURN CPGT C CHIPBREAKER	Positive 11° clearance 80° rhombic ground inserts for finishing	965
	TOTURN CPMT FG CHIPBREAKER	Positive 11° clearance 80° rhombic inserts for finishing	966
	TOTURN CPMT PC CHIPBREAKER	Positive 11° clearance 80° rhombic inserts for medium machining	966
	TOTURN DCET R/L-GF CHIPBREAKER	Positive 7° clearance 55° rhombic ground inserts for small parts	967
	TOTURN DCET R/L GW CHIPBREAKER	Positive 7° clearance 55° rhombic ground inserts with wiper geometry for small parts	967
	TOTURN DCMT FA CHIPBREAKER	Positive 7° clearance 80° rhombic inserts for super finishing	968
	TOTURN DCMT FG CHIPBREAKER	Positive 7° clearance 80° rhombic inserts for finishing	969
	TOTURN DCMT MT CHIPBREAKER	Positive 7° clearance 80° rhombic inserts for medium machining	970
	TOTURN RCMT MT CHIPBREAKER	Positive 7° clearance round inserts for medium machining	971
	TOTURN RCMX CHIPBREAKER	Positive 7° clearance round inserts for roughing	972
	TOTURN SCMT FG CHIPBREAKER	Positive 7° clearance square inserts for finishing	973

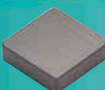
Carbide	Insert	Description	Page
	TOTURN SCMT MT CHIPBREAKER	Positive 7° clearance square inserts for medium machining	974
	TOTURN SPG	Positive 11° clearance flat top square ground inserts for finishing	975
	TOTURN SPMR CHIPBREAKER	Positive 11° clearance square inserts for medium machining	976
	TOTURN SPU	Positive 11° clearance flat top square inserts for medium machining	977
	TOTURN TCET R/L GF CHIPBREAKER	Positive 7° clearance triangular ground inserts for small parts	978
	TOTURN TCMT FG CHIPBREAKER	Positive 7° clearance triangular inserts for finishing	978
	TOTURN TCMT MT CHIPBREAKER	Positive 7° clearance triangular inserts for medium machining	979
	TOTURN TPG	Positive 11° clearance flat top, ground triangular inserts for finishing	980
	TOTURN TPGT R/L-C CHIPBREAKER	Positive 11° clearance triangular ground inserts for finishing	981
	TOTURN TPGX R/L CHIPBREAKER	Positive 11° clearance triangular ground inserts for finishing	982
	TOTURN TPMR COMMON CHIPBREAKER	Positive 11° clearance triangular inserts for medium machining	983
	TOTURN TPMT FG CHIPBREAKER	Positive 11° clearance triangular inserts for finishing	984

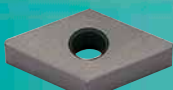
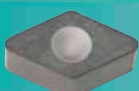
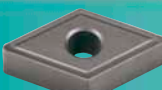
TURNING

Carbide	Insert	Description	Page
	TOTURN TPMT PC CHIPBREAKER	Positive 11° clearance triangular inserts for medium machining	984
	TOTURN TPU	Positive 11° clearance flat top triangular inserts for medium machining	985
	TOTURN VBET R/L-GF CHIPBREAKER	Positive 5° clearance 35° rhombic ground inserts for small parts	986
	TOTURN VBET R/L-GW CHIPBREAKER	Positive 5° clearance 35° rhombic ground inserts with wiper geometry for small parts	986
	TOTURN VBMT FA CHIPBREAKER	Positive 5° clearance 35° rhombic inserts for super finishing	987
	TOTURN VBMT FG CHIPBREAKER	Positive 5° clearance 35° rhombic inserts for finishing	988
	TOTURN VBMT MT CHIPBREAKER	Positive 5° clearance 35° rhombic inserts for medium machining	989
	TOTURN CCGT FL CHIPBREAKER	Positive 7° clearance 80° rhombic inserts for aluminum, ground and very sharp	990
	TOTURN DCGT FL CHIPBREAKER	Positive 7° clearance 55° rhombic inserts for aluminum, ground and very sharp	990
	TOTURN RCGT FL CHIPBREAKER	Positive 7° clearance angle round inserts for aluminum, ground and very sharp	991
	TOTURN SCGT FL CHIPBREAKER	Positive 7° clearance angle square inserts for aluminum, ground and very sharp	991
	TOTURN TCGT FL CHIPBREAKER	Positive 7° clearance triangular inserts for aluminum, ground and very sharp	992

Carbide / Ceramic	Insert	Description	Page
	TOTURN VCGT FL CHIPBREAKER	Positive 7° clearance 35° rhombic inserts, ground and very sharp	992
	TOTURN CNGA	80° rhombic ceramic inserts	993
	TOTURN CNGA WZ	80° rhombic ceramic inserts with wiper geometry	994
	TOTURN CNG	80° rhombic ceramic inserts, no hole	995
	TOTURN CNGX	80° rhombic ceramic inserts, dimple style	996
	TOTURN CNMG CE	80° rhombic ceramic inserts, pressed to size	996
	TOTURN DNGA	55° rhombic ceramic inserts	997
	TOTURN DNGX	55° rhombic ceramic inserts, dimple style	997
	TOTURN DNMG CE	55° rhombic ceramic inserts, pressed to size	998
	TOTURN HNGX	Hexagonal ceramic inserts, dimple style	998
	TOTURN RCGX	Positive 7°, round v-bottom ceramic inserts	999
	TOTURN RNG	Round ceramic inserts	999

TURNING

Ceramic	Insert	Description	Page
	TOTURN RPGX	Positive 11°, round v-bottom ceramic inserts	1000
	TOTURN SNGA	Square ceramic inserts	1000
	TOTURN SNGN	Square ceramic inserts, no hole	1001
	TOTURN SNGX	Square ceramic inserts, dimple style	1002
	TOTURN SNMG CE	Square ceramic inserts, pressed to size	1002
	TOTURN SPG	Positive 11° clearance square ceramic inserts	1003
	TOTURN TNGA	Triangle ceramic inserts	1003
	TOTURN TNGN	Triangle ceramic inserts, no hole	1004
	TOTURN TNMG CE	Triangle ceramic inserts, pressed to size	1004
	TOTURN TPG	Positive 11° triangle ceramic inserts	1005
	TOTURN VNGA	35° rhombic ceramic inserts	1005
	TOTURN VNGX	35° rhombic ceramic inserts, dimple style	1006

Ceramic / CBN	Insert	Description	Page
	TOTURN WNGA	80° trigon ceramic inserts	1006
	TOTURN WNGA WZ	80° trigon ceramic inserts with wiper geometry	1007
	TOTURN T11-3219	Positive 6° clearance round ceramic inserts for roll machining	1007
	TOTURN CCGW LS	Positive 7° clearance 80° rhombic CBN-tipped inserts	1008
	TOTURN CNMA LN/ LS	80° rhombic CBN-tipped inserts	1009
	TOTURN CNGA WZ-LS	80° rhombic CBN-tipped inserts with wiper geometry	1009
	TOTURN CNMN SD	80° rhombic solid CBN inserts	1010
	TOTURN DCGW LS	Positive 7° clearance, 55° rhombic CBN-tipped inserts	1010
	TOTURN DNMA LN/ LS	55° rhombic CBN-tipped inserts	1011
	TOTURN RCGX FT	Positive 7° round, full-top CBN inserts	1011
	TOTURN RNMN FT	Round, full-top CBN inserts	1012
	TOTURN RNMN SD	Round, solid CBN inserts	1012

TURNING

CBN / PCD	Insert	Description	Page
	TOTURN SNGN LN	Square CBN-tipped inserts, no hole	1013
	TOTURN SNMA LN	Square CBN-tipped inserts	1013
	TOTURN SNM SD	Square, solid CBN inserts	1014
	TOTURN TCGW LS	Positive 7° clearance, triangle CBN-tipped inserts	1014
	TOTURN TNMA LN/LS	Triangular, CBN-tipped inserts	1015
	TOTURN TPGN LS	Positive 11° clearance, triangular CBN-tipped inserts, no hole	1015
	TOTURN VBGW LN/LS	Positive 5° clearance, 35° rhombic CBN-tipped inserts	1016
	TOTURN VNGA LN/LS	35° rhombic CBN-tipped inserts	1016
	TOTURN WNGA WZ-LS	80° Trigon, CBN-tipped inserts	1017
	TOTURN CCGW LN-7	Positive 7° clearance, 80° rhombic PCD-tipped inserts	1018
	TOTURN CNMA LN-10	80° rhombic PCD-tipped inserts	892
	TOTURN DCGW LN-7	Positive 7° clearance, 55° rhombic PCD-tipped inserts	892

PCD	Insert	Description	Page
	TOTURN DNMA LN-10	55° Rhombic PCD-tipped inserts	1019
	TOTURN SNMA LN-10	Square, PCD-tipped inserts	1020
	TOTURN TCGW LN-7	Positive 7° clearance, triangular PCD-tipped inserts	1020
	TOTURN TNMA LN-10	Triangular PCD-tipped inserts	1021
	TOTURN TPGN LN-7	Positive 11° triangular PCD-tipped inserts, no hole	1021
	TOTURN VBGW LN-7	Positive 5° clearance, 35° rhombic PCD-tipped inserts	1022
	TOTURN VCGW LN-7	Positive 7° clearance, 35° rhombic PCD-tipped inserts	1022
	TOTURN VNGA LN-10	35° Rhombic PCD-tipped inserts	1023

NEGATIVE 80 DEGREE RHOMBIC FLAT TOP INSERTS FOR ROUGHING

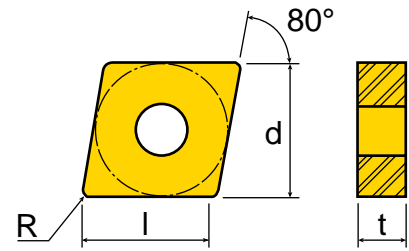
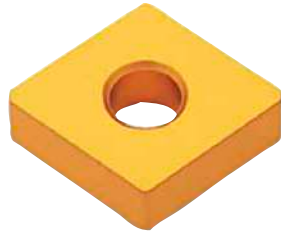

ANSI Number	ISO Number	feed (ipr)	ap (inch)	l	d	t	R	Grade	K10	T1300	T7310	T8115
CNMA431	CNMA120404	.012 (.006-.018)	.118 (.039-.197)	0.488	0.500	0.187	0.016		●	●	●	
CNMA432	CNMA120408	.018 (.006-.028)	.118 (.039-.236)	0.472	0.500	0.187	0.031		●	●	●	
CNMA433	CNMA120412	.022 (.006-.028)	.118 (.059-.236)	0.457	0.500	0.187	0.047			●	●	●
CNMA434	CNMA120416	.024 (.008-.032)	.118 (.059-.236)	0.441	0.500	0.187	0.063				●	●
CNMA543	CNMA160612	.022 (.006-.028)	.157 (.059-.315)	0.583	0.625	0.250	0.047			●	●	
CNMA641	CNMA190604	.022 (.006-.028)	.236 (.059-.394)	0.744	0.750	0.250	0.016					
CNMA642	CNMA190608	.022 (.006-.028)	.236 (.059-.394)	0.728	0.750	0.250	0.031			●	●	
CNMA643	CNMA190612	.022 (.006-.028)	.236 (.059-.394)	0.713	0.750	0.250	0.047			●	●	
CNMA644	CNMA190616	.022 (.006-.028)	.236 (.059-.394)	0.697	0.750	0.250	0.063				●	

For use in holders MCLNR/L, TCKNR/L, TCLNR/L, TCMNN, TCRNR/L, S-MCLNR/L, A-TCLNR/L, see pages 1049, 1084, 1086, 1088, 1089, 1116, 1137.

● = P ● = M ● = K ● = N ● = S ○ = H

TOTURN™ CNGG ML CHIPBREAKER

NEGATIVE 80 DEGREE RHOMBIC GROUND INSERTS FOR MEDIUM LIGHT MACHINING / VERY POSITIVE RAKE ANGLE

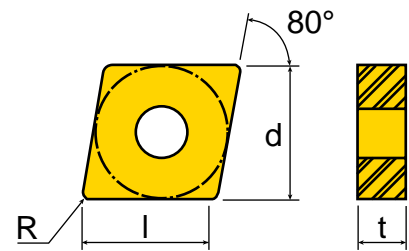
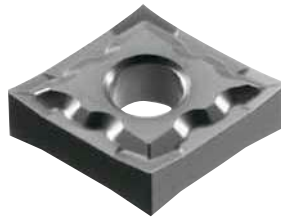

ANSI Number	ISO Number	feed (ipr)	ap (inch)	l	d	t	R	Grade	K10	T15030	T18020
CNGG430ML	CNGG120401ML	.002 (.001-.004)	.008 (.004-.039)	0.504	0.500	0.187	0.004		●	●	
CNGG430.5ML	CNGG120402ML	.003 (.002-.006)	.012 (.008-.047)	0.500	0.500	0.187	0.008		●	●	
CNGG431ML	CNGG120404ML	.007 (.004-.012)	.059 (.031-.138)	0.488	0.500	0.187	0.016		●	●	
CNGG432ML	CNGG120408ML	.010 (.005-.014)	.079 (.039-.138)	0.472	0.500	0.187	0.031		●	●	●

For use in holders MCLNR/L, TCKNR/L, TCLNR/L, TCMNN, TCRNR/L, S-MCLNR/L, A-TCLNR/L, see pages 1049, 1084, 1086, 1088, 1089, 1116, 1137.

● = P ● = M ● = K ● = N ● = S ○ = H

TOTURN™ CNMG COMMON CHIPBREAKER

COMMON TYPE CHIPBREAKER NEGATIVE 80 DEGREE RHOMBIC INSERTS FOR MEDIUM ROUGHING.

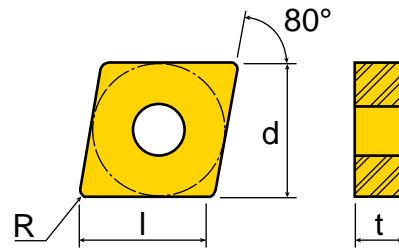

ANSI Number	ISO Number	feed (ipr)	ap (inch)	l	d	t	R
CNMG322	CNMG090308	.016 (.008-.020)	.079 (.039-.138)	0.346	0.375	0.125	0.031
CNMG431	CNMG120404	.011 (.007-.018)	.118 (.039-.197)	0.488	0.500	0.187	0.016
CNMG432	CNMG120408	.016 (.009-.024)	.118 (.059-.197)	0.472	0.500	0.187	0.031
CNMG433	CNMG120412	.020 (.010-.024)	.118 (.079-.197)	0.457	0.500	0.187	0.047
CNMG434	CNMG120416	.020 (.011-.026)	.118 (.079-.197)	0.441	0.500	0.187	0.063
CNMG532	CNMG160408	.016 (.010-.024)	.157 (.079-.256)	0.602	0.625	0.187	0.031
CNMG541	CNMG160604	.011 (.008-.018)	.157 (.079-.256)	0.618	0.625	0.250	0.016
CNMG542	CNMG160608	.016 (.010-.024)	.157 (.079-.256)	0.602	0.625	0.250	0.031
CNMG543	CNMG160612	.014 (.011-.024)	.157 (.079-.256)	0.583	0.625	0.250	0.047
CNMG641	CNMG190604	.011 (.008-.018)	.197 (.118-.315)	0.744	0.750	0.250	0.016
CNMG642	CNMG190608	.016 (.010-.024)	.197 (.118-.315)	0.728	0.750	0.250	0.031
CNMG643	CNMG190612	.020 (.012-.024)	.197 (.118-.315)	0.713	0.750	0.250	0.047
CNMG644	CNMG190616	.022 (.014-.028)	.197 (.118-.315)	0.697	0.750	0.250	0.063

For use in holders MCLNR/L, TCKNR/L, TCLNR/L, TCMNN, TCRNR/L, S-MCLNR/L, S-PCLNR/L, A-TCLNR/L, see pages 1049, 1084, 1086, 1088, 1089, 1116, 1137.

Part Number	Grade	CT3000	K10	K20	P20	P30	TT1300	TT5100	TT7100	TT7310	TT8020	TT8115	TT8125						
CNMG322							●	●				●	●						
CNMG431				●	●		●	●		●	●	●	●						
CNMG432		●	●	●	●	●	●	●	●	●	●	●	●						
CNMG433				●			●	●		●		●	●						
CNMG434				●															
CNMG532													●						
CNMG541													●						
CNMG542								●				●	●						
CNMG543													●						
CNMG641								●				●	●						
CNMG642							●		●	●		●	●						
CNMG643							●	●	●			●	●						
CNMG644								●				●	●						
CNMG434			●									●							

● = P ● = M ● = K ● = N ● = S ○ = H



TOTURN™ CNMG EA CHIPBREAKER

NEGATIVE 80 DEGREE RHOMBIC INSERTS FOR SEMI-FINISH TO FINISHING

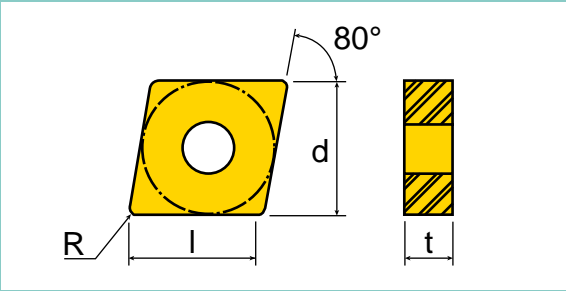

ANSI Number	ISO Number	feed (ipr)	ap (inch)	l	d	t	R
CNMG431EA	CNMG120404EA	.004 (.002-.012)	.020 (.006-.060)	0.488	0.500	0.187	0.016
CNMG432EA	CNMG120408EA	.008 (.003-.016)	.020 (.012-.060)	0.472	0.500	0.187	0.031

For use in holders MCLNR/L, TCKNR/L, TCLNR/L, TCMNN, TCRNR/L, S-MCLNR/L, A-TCLNR/L, see [pages 1049, 1084, 1086, 1088, 1089, 1116, 1137](#).

Part Number	Grade	CT3000	TT5030	TT5100	TT8020	TT8115	TT8125										
CNMG431EA		●	●	●	●	●	●										
CNMG432EA		●	●	●	●	●											

● = P ● = M ● = K ● = N ● = S ○ = H

TOTURN™ CNMG ET CHIPBREAKER

NEGATIVE 80 DEGREE RHOMBIC INSERTS FOR MEDIUM TO ROUGH MACHINING

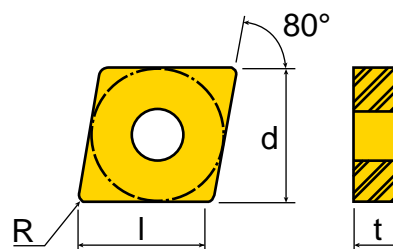

ANSI Number	ISO Number	feed (ipr)	ap (inch)	l	d	t	R
CNMG432ET	CNMG120408ET	.014 (.007-.022)	.118 (.047-.217)	0.488	0.500	0.187	0.031
CNMG433ET	CNMG120412ET	.014 (.008-.024)	.118 (.047-.217)	0.472	0.500	0.187	0.047
CNMG543ET	CNMG160612ET	.017 (.010-.024)	.178 (.100-.276)	0.583	0.625	0.250	0.047
CNMG643ET	CNMG190612ET	.017 (.010-.024)	.236 (.118-.354)	0.712	0.750	0.250	0.047
CNMG644ET	CNMG190616ET	.020 (.012-.026)	.236 (.118-.354)	0.697	0.750	0.250	0.063

For use in holders MCLNR/L, TCKNR/L, TCLNR/L, TCMNN, TCRNR/L, S-MCLNR/L, A-TCLNR/L, see pages 1049, 1084, 1086, 1088, 1089, 1116, 1137.

Part Number	Grade														
		TT5030	TT5100	TT8115	TT8125	TT9215	TT9225	TT9235							
CNMG432ET		●	●		●	●	●								
CNMG433ET		●	●	●		●	●								
CNMG543ET		●	●		●	●	●								
CNMG643ET		●			●	●	●								
CNMG644ET		●	●				●	●							

● = P ● = M ● = K ● = N ● = S ○ = H

TOTURN™ CNMG FA CHIPBREAKER

NEGATIVE 80 DEGREE RHOMBIC INSERTS FOR SUPER FINISHING

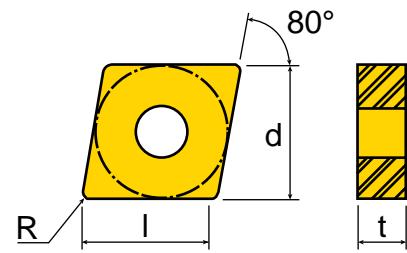
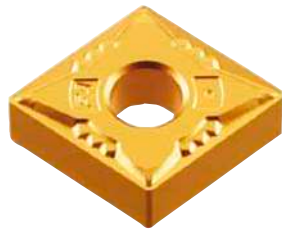

ANSI Number	ISO Number	feed (ipr)	ap (inch)	l	d	t	R	Grade	CT3000	PV3010	TT5100	TT8115	TT8125
CNMG431FA	CNMG120404FA	.004 (.002-.008)	.016 (.008-.079)	0.488	0.500	0.187	0.016						
CNMG432FA	CNMG120408FA	.005 (.002-.010)	.020 (.012-.079)	0.472	0.500	0.187	0.031						

For use in holders MCLNR/L, TCKNR/L, TCLNR/L, TCMNN, TCRNR/L, S-MCLNR/L, A-TCLNR/L, see pages 1049, 1084, 1086, 1088, 1089, 1116, 1137.

● = P ● = M ● = K ● = N ● = S ○ = H

TOTURN™ CNMG FC CHIPBREAKER

NEGATIVE 80 DEGREE RHOMBIC INSERTS FOR FINISHING

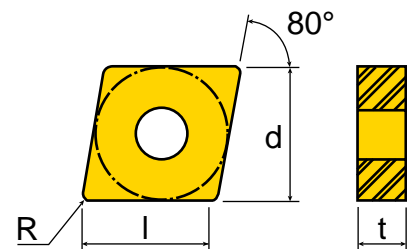
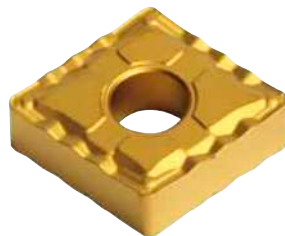

ANSI Number	ISO Number	feed (ipr)	ap (inch)	l	d	t	R
CNMG431FC	CNMG120404FC	.003 (.001-.011)	.019 (.005-.059)	0.488	0.500	0.187	0.016
CNMG432FC	CNMG120408FC	.007 (.002-.013)	.019 (.005-.059)	0.472	0.500	0.187	0.031
CNMG433FC	CNMG120412FC	.008 (.003-.016)	.031 (.031-.118)	0.435	0.500	0.187	0.047

For use in holders MCLNR/L, TCKNR/L, TCLNR/L, TCMNN, TCRNR/L, S-MCLNR/L, A-TCLNR/L, see pages 1049, 1084, 1086, 1088, 1089, 1116, 1137.

Part Number	Grade	CT3000	PV3010	TT5100	TT8115	TT8125	TT9215	TT9225	TT9235
CNMG431FC									
CNMG432FC									
CNMG433FC									

● = P ● = M ● = K ● = N ● = S ○ = H

TOTURN™ CNMG FG CHIPBREAKER

NEGATIVE 80 DEGREE RHOMBIC INSERTS FOR FINISHING

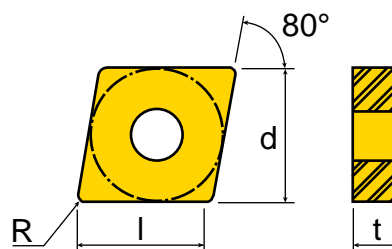

ANSI Number	ISO Number	feed (ipr)	ap (inch)	l	d	t	R	Grade				
								CT3000	PV3010	TT5100	TT8115	TT8125
CNMG321FG	CNMG090304FG	.004 (.003-.008)	.031 (.020-.079)	0.362	0.375	0.125	0.016	●	●	●	●	●
CNMG322FG	CNMG090308FG	.006 (.004-.010)	.039 (.028-.079)	0.346	0.375	0.125	0.031	●	●	●	●	●
CNMG431FG	CNMG120404FG	.004 (.003-.008)	.031 (.020-.079)	0.488	0.500	0.187	0.016	●	●	●	●	●
CNMG432FG	CNMG120408FG	.006 (.004-.010)	.039 (.028-.079)	0.472	0.500	0.187	0.031	●	●	●	●	●

For use in holders MCLNR/L, TCKNR/L, TCLNR/L, TCMNN, TCRNR/L, S-MCLNR/L, S-PCLNR/L, A-TCLNR/L, see pages 1049, 1084, 1086, 1088, 1089, 1116, 1123, 1137.

● = P ● = M ● = K ● = N ● = S ○ = H

TOTURN™ CNMG MC CHIPBREAKER

NEGATIVE 80 DEGREE RHOMBIC INSERTS FOR MEDIUM MACHINING / NEGATIVE RAKE ANGLE

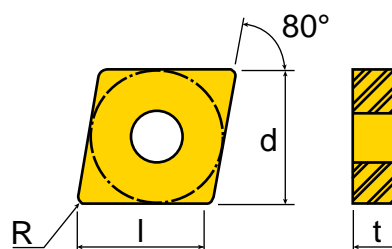

ANSI Number	ISO Number	feed (ipr)	ap (inch)	l	d	t	R
CNMG431MC	CNMG120404MC	.008 (.004-.012)	.059 (.028-.138)	0.488	0.500	0.187	0.016
CNMG432MC	CNMG120408MC	.012 (.005-.014)	.059 (.028-.138)	0.472	0.500	0.187	0.031
CNMG433MC	CNMG120412MC	.014 (.006-.016)	.059 (.028-.138)	0.457	0.500	0.187	0.047

For use in holders MCLNR/L, TCKNR/L, TCLNR/L, TCMNN, TCRNR/L, S-MCLNR/L, A-TCLNR/L, see pages 1049, 1084, 1086, 1088, 1089, 1116, 1137.

Part Number	Grade	CT3000	TT5100	TT7100	TT7310	TT8020	TT8115	TT8125									
CNMG431MC		●	●				●	●									
CNMG432MC		●	●	●	●	●	●	●									
CNMG433MC			●				●	●									

● = P ● = M ● = K ● = N ● = S ○ = H

TOTURN™ CNMG ML CHIPBREAKER

NEGATIVE 80 DEGREE RHOMBIC INSERTS FOR MEDIUM LIGHT MACHINING / VERY POSITIVE RAKE ANGLE

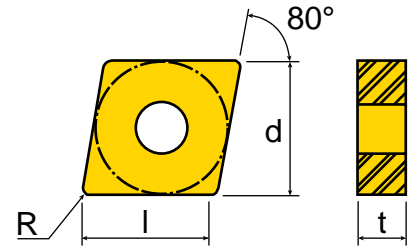

ANSI Number	ISO Number	feed (ipr)	ap (inch)	l	d	t	R
CNMG431ML	CNMG120404ML	.007 (.004-.012)	.059 (.031-.138)	0.488	0.500	0.187	0.016
CNMG432ML	CNMG120408ML	.010 (.005-.014)	.079 (.039-.138)	0.472	0.500	0.187	0.031
CNMG433ML	CNMG120412ML	.012 (.006-.014)	.079 (.051-.138)	0.457	0.500	0.187	0.047
CNMG643ML	CNMG190612ML	.012 (.008-.014)	.157 (.079-.236)	0.713	0.750	0.250	0.047

For use in holders MCLNR/L, TCKNR/L, TCLNR/L, TCMNN, TCRNR/L, S-MCLNR/L, A-TCLNR/L, see pages 1049, 1084, 1086, 1088, 1089, 1116, 1137.

Part Number	Grade																
		CT3000	K10	TT5030	TT5100	TT8020	TT8115	TT8125	TT9030	TT9215	TT9225						
CNMG431ML		●	●	●	●	●	●	●		●	●						
CNMG432ML		●	●	●	●	●	●	●	●	●	●						
CNMG433ML				●	●		●										
CNMG643ML				●													

● = P ● = M ● = K ● = N ● = S ○ = H

TOTURN™ CNMG MP CHIPBREAKER

NEGATIVE 80 DEGREE RHOMBIC INSERTS FOR MEDIUM MACHINING / POSITIVE RAKE ANGLE

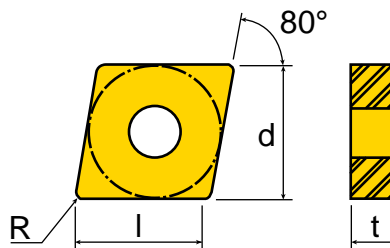

ANSI Number	ISO Number	feed (ipr)	ap (inch)	l	d	t	R
CNMG321MP	CNMG090304MP	.008 (.004-.012)	.059 (.031-.118)	0.362	0.375	0.125	0.016
CNMG322MP	CNMG090308MP	.012 (.005-.014)	.059 (.031-.118)	0.346	0.375	0.125	0.031
CNMG431MP	CNMG120404MP	.008 (.004-.012)	.079 (.031-.157)	0.488	0.500	0.187	0.016
CNMG432MP	CNMG120408MP	.012 (.005-.016)	.079 (.031-.157)	0.472	0.500	0.187	0.031
CNMG433MP	CNMG120412MP	.014 (.006-.020)	.079 (.031-.157)	0.457	0.500	0.187	0.047
CNMG543MP	CNMG160612MP	.014 (.006-.020)	.118 (.098-.236)	0.583	0.625	0.250	0.047

For use in holders MCLNR/L, TCKNR/L, TCLNR/L, TCMNN, TCRNR/L, S-MCLNR/L, S-PCLNR/L, A-TCLNR/L, see pages 1049, 1084, 1086, 1088, 1089, 1116, 1123, 1137.

Part Number	Grade	K10	TT5030	TT5100	TT8020	TT8115	TT8125	TT9030	TT9215	TT9225	TT9235								
CNMG321MP				●		●	●												
CNMG322MP				●		●	●												
CNMG431MP			●	●	●	●	●		●	●	●								
CNMG432MP			●	●	●	●	●	●	●	●	●								
CNMG433MP		●	●	●	●	●			●	●	●								
CNMG543MP							●												

● = P ● = M ● = K ● = N ● = S ○ = H

TOTURN™ CNMG MT CHIPBREAKER

NEGATIVE 80 DEGREE RHOMBIC INSERTS FOR MEDIUM ROUGHING / TOUGH RAKE ANGLE

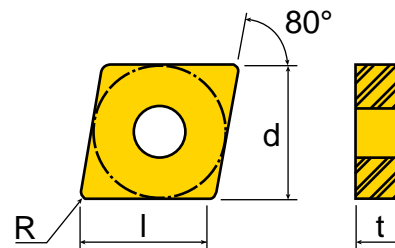

ANSI Number	ISO Number	feed (ipr)	ap (inch)	l	d	t	R
CNMG321MT	CNMG090304MT	.010 (.005-.016)	.079 (.031-.138)	0.362	0.375	0.125	0.016
CNMG322MT	CNMG090308MT	.014 (.007-.018)	.079 (.039-.138)	0.346	0.375	0.125	0.031
CNMG431MT	CNMG120404MT	.010 (.006-.016)	.118 (.039-.197)	0.488	0.500	0.187	0.016
CNMG432MT	CNMG120408MT	.014 (.007-.022)	.118 (.047-.197)	0.472	0.500	0.187	0.031
CNMG433MT	CNMG120412MT	.017 (.008-.022)	.118 (.059-.197)	0.457	0.500	0.187	0.047
CNMG542MT	CNMG160608MT	.014 (.008-.022)	.157 (.079-.256)	0.602	0.625	0.250	0.031
CNMG543MT	CNMG160612MT	.017 (.009-.022)	.157 (.079-.256)	0.583	0.625	0.250	0.047
CNMG544MT	CNMG160616MT	.018 (.012-.022)	.157 (.079-.256)	0.567	0.625	0.250	0.063
CNMG642MT	CNMG190608MT	.014 (.009-.022)	.197 (.118-.315)	0.728	0.750	0.250	0.031
CNMG643MT	CNMG190612MT	.017 (.010-.022)	.236 (.118-.315)	0.713	0.750	0.250	0.047
CNMG644MT	CNMG190616MT	.018 (.012-.022)	.236 (.118-.315)	0.697	0.750	0.250	0.063

For use in holders MCLNR/L, TCKNR/L, TCLNR/L, TCMNN, TCRNR/L, S-MCLNR/L, S-PCLNR/L, A-TCLNR/L, see [pages 1049, 1084, 1086, 1088, 1089, 1116, 1123, 1137](#).

Part Number	Grade	CT3000	PV3010	TT1300	TT5030	TT5100	TT7100	TT7310	TT8020	TT8115	TT8125	TT9030	TT9215	TT9225	TT9235				
CNMG321MT		●		●		●				●	●								
CNMG322MT				●		●				●	●								
CNMG431MT		●			●	●		●	●	●	●								
CNMG432MT		●	●	●	●	●	●	●	●	●	●	●	●	●	●	●			
CNMG433MT		●		●	●	●	●	●	●	●	●		●	●	●				
CNMG542MT				●							●								
CNMG543MT				●	●	●		●	●	●	●	●							
CNMG544MT					●	●													
CNMG642MT				●	●	●			●	●	●		●	●	●				
CNMG643MT				●	●	●			●	●	●	●	●	●	●				
CNMG644MT										●	●								

● = P ● = M ● = K ● = N ● = S ○ = H

TOTURN™ CNMG PC CHIPBREAKER

NEGATIVE 80 DEGREE RHOMBIC INSERTS FOR MEDIUM MACHINING

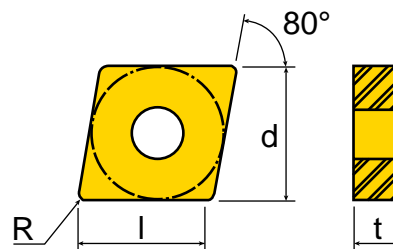
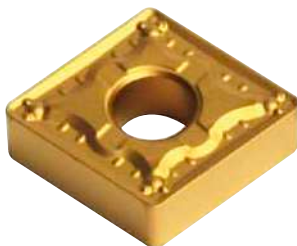

ANSI Number	ISO Number	feed (ipr)	ap (inch)	l	d	t	R
CNMG322PC	CNMG090308PC	.006 (.004-.010)	.039 (.024-.079)	0.346	0.375	0.125	0.031
CNMG431PC	CNMG120404PC	.010 (.004-.016)	.098 (.016-.197)	0.488	0.500	0.187	0.016
CNMG432PC	CNMG120408PC	.012 (.006-.020)	.098 (.020-.197)	0.472	0.500	0.187	0.031
CNMG433PC	CNMG120412PC	.014 (.007-.022)	.098 (.024-.197)	0.456	0.500	0.187	0.047
CNMG434PC	CNMG120416PC	.016 (.008-.024)	.098 (.031-.197)	0.441	0.500	0.187	0.063
CNMG542PC	CNMG160608PC	.014 (.008-.022)	.157 (.079-.256)	0.602	0.625	0.250	0.031
CNMG543PC	CNMG160612PC	.017 (.010-.022)	.157 (.079-.256)	0.583	0.625	0.250	0.047
CNMG544PC	CNMG160616PC	.018 (.012-.022)	.157 (.079-.256)	0.567	0.625	0.250	0.063
CNMG642PC	CNMG190608PC	.014 (.009-.022)	.197 (.118-.315)	0.728	0.750	0.250	0.031
CNMG643PC	CNMG190612PC	.017 (.010-.022)	.197 (.118-.315)	0.713	0.750	0.250	0.047

For use in holders MCLNR/L, TCKNR/L, TCLNR/L, TCMNN, TCRNR/L, S-MCLNR/L, S-PCLNR/L, A-TCLNR/L, see [pages 1049, 1084, 1086, 1088, 1089, 1116, 1123, 1137](#).

Part Number	Grade	TT5030	TT5100	TT7100	TT8115	TT8125	TT9215	TT9225	TT9235										
CNMG322PC					●	●													
CNMG431PC			●		●	●	●	●	●										
CNMG432PC			●		●	●	●	●	●										
CNMG433PC			●		●	●	●	●	●										
CNMG434PC		●		●	●	●													
CNMG542PC						●													
CNMG543PC					●	●													
CNMG544PC						●													
CNMG642PC						●													
CNMG643PC					●	●													

● = P ● = M ● = K ● = N ● = S ○ = H

TOTURN™ CNMG RT CHIPBREAKER

NEGATIVE 80 DEGREE RHOMBIC INSERTS FOR ROUGHING / WIDE, TOUGH RAKE ANGLE

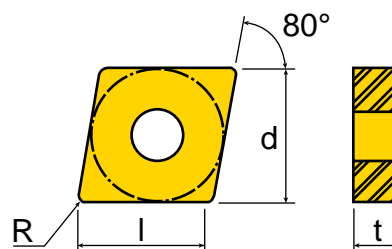
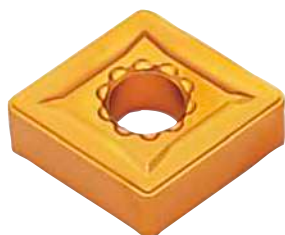

ANSI Number	ISO Number	feed (ipr)	ap (inch)	l	d	t	R
CNMG432RT	CNMG120408RT	.018 (.010-.028)	.157 (.098-.236)	0.472	0.500	0.187	0.031
CNMG433RT	CNMG120412RT	.022 (.010-.028)	.157 (.098-.236)	0.457	0.500	0.187	0.047
CNMG434RT	CNMG120416RT	.024 (.010-.030)	.157 (.098-.236)	0.441	0.500	0.187	0.063
CNMG543RT	CNMG160612RT	.018 (.010-.028)	.157 (.098-.236)	0.583	0.625	0.250	0.047
CNMG544RT	CNMG160616RT	.025 (.012-.033)	.157 (.118-.276)	0.567	0.625	0.250	0.063
CNMG642RT	CNMG190608RT	.018 (.010-.028)	.236 (.118-.354)	0.728	0.750	0.250	0.031
CNMG643RT	CNMG190612RT	.022 (.010-.028)	.236 (.118-.354)	0.713	0.750	0.250	0.047
CNMG644RT	CNMG190616RT	.025 (.012-.033)	.236 (.118-.354)	0.697	0.750	0.250	0.063
CNMG866RT	CNMG250924RT	.033 (.018-.039)	.315 (.197-.472)	0.917	1.000	0.375	0.094

For use in holders MCLNR/L, TCKNR/L, TCLNR/L, TCMNN, TCRNR/L, S-MCLNR/L, A-TCLNR/L, see pages 1049, 1084, 1086, 1088, 1089, 1116, 1137.

Part Number	Grade	TT1300	TT5030	TT5100	TT7100	TT7310	TT8020	TT8115	TT8125	TT9215	TT9225	TT9235						
CNMG432RT		●	●	●	●	●		●	●	●	●	●						
CNMG433RT		●		●	●	●		●	●	●	●	●						
CNMG434RT				●	●	●		●										
CNMG543RT		●	●	●	●	●		●	●									
CNMG544RT		●		●		●		●	●									
CNMG642RT		●		●				●	●									
CNMG643RT		●	●	●	●	●		●	●		●	●						
CNMG644RT		●		●	●	●	●	●	●									
CNMG866RT				●	●			●	●									

● = P ● = M ● = K ● = N ● = S ○ = H

TOTURN™ CNMG SF CHIPBREAKER

NEGATIVE 80 DEGREE RHOMBIC INSERTS FOR SEMI-FINISHING TO FINISHING

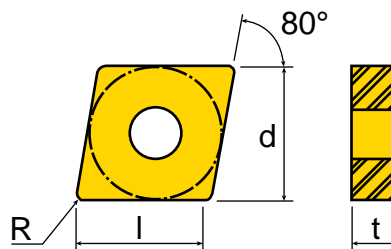
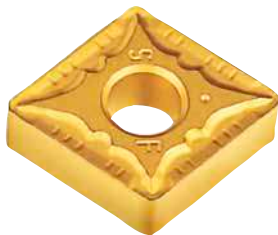

ANSI Number	ISO Number	feed (ipr)	ap (inch)	l	d	t	R
CNMG431SF	CNMG120404SF	.005 (.003-.010)	.030 (.020-.059)	0.488	0.500	0.187	0.016
CNMG432SF	CNMG120408SF	.008 (.004-.012)	.039 (.028-.059)	0.472	0.500	0.187	0.031

For use in holders MCLNR/L, TCKNR/L, TCLNR/L, TCMNN, TCRNR/L, S-MCLNR/L, A-TCLNR/L, see pages 1049, 1084, 1086, 1088, 1089, 1116, 1137.

Part Number	Grade	CT3000	TT5030	TT5100	TT8115	TT8125	TT9030								
CNMG431SF		●	●	●			●								
CNMG432SF		●	●	●	●	●									

● = P ● = M ● = K ● = N ● = S ○ = H

TOTURN™ CNMG WS CHIPBREAKER

NEGATIVE 80 DEGREE RHOMBIC WIPER INSERTS FOR SUPER FINISHING

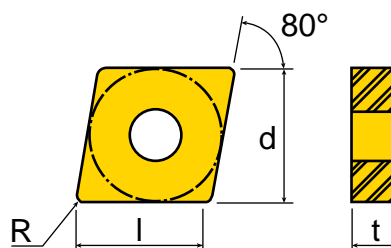
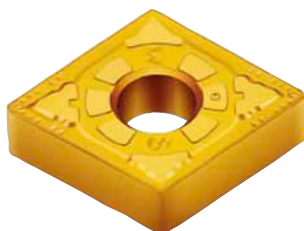

ANSI Number	ISO Number	feed (ipr)	ap (inch)	l	d	t	R	Grade	CT3000	TT5100	TT8115	TT8125
CNMG431WS	CNMG120404WS	.008 (.002-.014)	.039 (.020-.079)	0.488	0.500	0.187	0.016		●	●	●	●

For use in holders MCLNR/L, TCKNR/L, TCLNR/L, TCMNN, TCRNR/L, S-MCLNR/L, A-TCLNR/L, see pages 1049, 1084, 1086, 1088, 1089, 1116, 1137.

● = P ● = M ● = K ● = N ● = S ○ = H

TOTURN™ CNMG WT CHIPBREAKER

NEGATIVE 80 DEGREE RHOMBIC WIPER INSERTS FOR MEDIUM ROUGHING

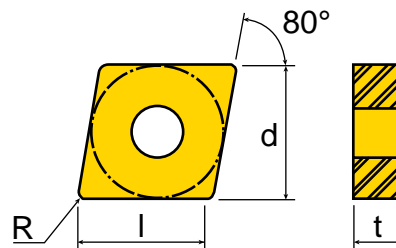
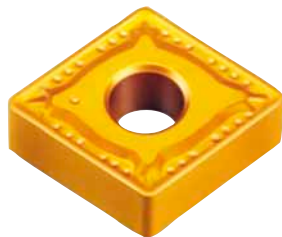

ANSI Number	ISO Number	feed (ipr)	ap (inch)	l	d	t	R
CNMG432WT	CNMG120408WT	.018 (.006-.024)	.079 (.039-.197)	0.472	0.500	0.187	0.031
CNMG433WT	CNMG120412WT	.020 (.008-.031)	.079 (.039-.197)	0.457	0.500	0.187	0.047

For use in holders MCLNR/L, TCKNR/L, TCLNR/L, TCMNN, TCRNR/L, S-MCLNR/L, A-TCLNR/L, see pages 1049, 1084, 1086, 1088, 1089, 1116, 1137.

Part Number	Grade	CT3000	TT1300	TT5030	TT5100	TT7310	TT8115	TT8125	TT9215							
		CNMG432WT	●●●●●●●●●●	●	●	●	●	●	●	●	●					
CNMG433WT	●●●●●●●●●●	●	●	●	●	●	●	●	●							

● = P ● = M ● = K ● = N ● = S ○ = H

TOTURN™ CNMM HT CHIPBREAKER

NEGATIVE 80 DEGREE RHOMBIC INSERTS FOR HEAVY TURNING APPLICATIONS

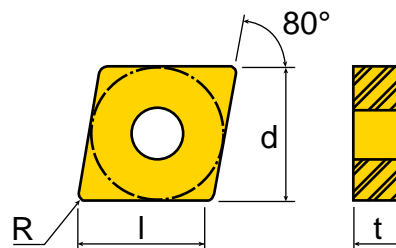

ANSI Number	ISO Number	feed (ipr)	ap (inch)	l	d	t	R	Grade	TT5100	TT7100	TT8115	TT8125	TT9225
CNMM643HT	CNMM190612HT	.024 (.014-.035)	.236 (.157-.354)	0.713	0.750	0.250	0.047	●●●●●●●●●●	●	●	●	●	
CNMM644HT	CNMM190616HT	.024 (.014-.035)	.236 (.157-.354)	0.697	0.750	0.250	0.063	●●●●●●●●●●	●	●	●	●	
CNMM646HT	CNMM190624HT	.024 (.014-.035)	.236 (.157-.354)	0.661	0.750	0.250	0.094	●●●●●●●●●●				●	
CNMM856HT	CNMM250724HT	.040 (.022-.051)	.315 (.197-.472)	0.917	1.000	0.313	0.094	●●●●●●●●●●					●
CNMM866HT	CNMM250924HT	.040 (.022-.051)	.315 (.197-.472)	0.917	1.000	0.375	0.094	●●●●●●●●●●	●	●	●	●	

For use in holders MCLNR/L, TCLNR/L, TCMNN, S-MCLNR/L, see pages 1049, 1086, 1088, 1116.

● = P ● = M ● = K ● = N ● = S ○ = H

TOTURN™ CNMM HY CHIPBREAKER

NEGATIVE 80 DEGREE RHOMBIC INSERTS FOR HEAVY ROUGHING

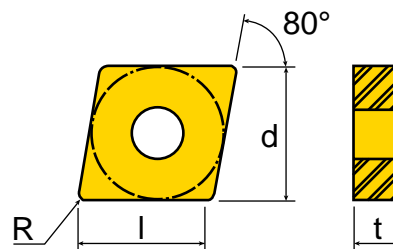
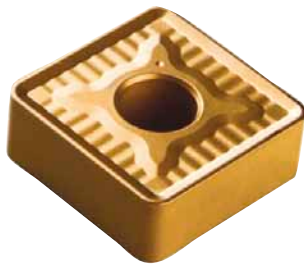

ANSI Number	ISO Number	feed (ipr)	ap (inch)	l	d	t	R	Grade				
								T8115	T8125			
CNMM646HY	CNMM190624	.033 (.020-.043)	.354 (.157-.472)	0.661	0.750	0.250	0.094	●	●			
CNMM866HY	CNMM250924	.040 (.022-.059)	.394 (.157-.591)	0.917	1.000	0.375	0.094		●			

For use in holders MCLNR/L, TCLNR/L, TCMNN, S-MCLNR/L, see [pages 1049, 1086, 1088, 1116](#).

● = P ● = M ● = K ● = N ● = S ○ = H

TOTURN™ CNMM HZ CHIPBREAKER

NEGATIVE 80 DEGREE RHOMBIC INSERTS FOR HEAVY ROUGHING

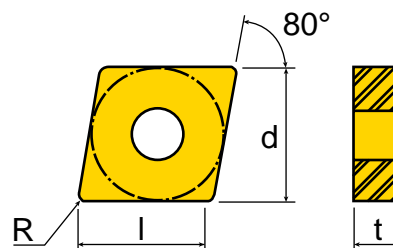

ANSI Number	ISO Number	feed (ipr)	ap (inch)	l	d	t	R	Grade				
								T8115	T8125			
CNMM866HZ	CNMM250924HZ	.043 (.024-.059)	.394 (.138-.630)	0.917	1.000	0.375	0.094	●	●			

● = P ● = M ● = K ● = N ● = S ○ = H

TOTURN™ CNMM RH & RH(N) CHIPBREAKER

NEGATIVE 80 DEGREE RHOMBIC INSERTS FOR HIGH FEED ROUGHING



RH



RH(N)

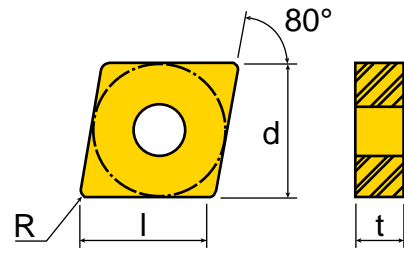

ANSI Number	ISO Number	feed (ipr)	ap (inch)	l	d	t	R
CNMM432RH	CNMM120408RH	.020 (.012-.031)	.157 (.098-.236)	0.472	0.500	0.187	0.031
CNMM432RH(N)	CNMM120408RH(N)	.018 (.010-.028)	.118 (.078-.196)	0.472	0.500	0.187	0.031
CNMM433RH	CNMM120412RH	.025 (.012-.031)	.157 (.098-.236)	0.457	0.500	0.187	0.047
CNMM542RH	CNMM160608RH	.020 (.012-.031)	.197 (.118-.315)	0.602	0.625	0.250	0.031
CNMM543RH	CNMM160612RH	.025 (.012-.031)	.197 (.118-.315)	0.583	0.625	0.250	0.047
CNMM544RH	CNMM160616RH	.028 (.018-.039)	.197 (.157-.315)	0.567	0.625	0.250	0.063
CNMM642RH	CNMM190608RH	.020 (.012-.031)	.236 (.118-.354)	0.728	0.750	0.250	0.031
CNMM643RH	CNMM190612RH	.025 (.012-.031)	.236 (.118-.354)	0.713	0.750	0.250	0.047
CNMM643RH(N)	CNMM190612RH(N)	.022 (.012-.028)	.197 (.098-.315)	0.713	0.750	0.250	0.047
CNMM644RH	CNMM190616RH	.028 (.018-.039)	.236 (.157-.354)	0.697	0.750	0.250	0.063
CNMM644RH(N)	CNMM190616RH(N)	.024 (.016-.032)	.197 (.098-.315)	0.697	0.750	0.250	0.063
CNMM646RH	CNMM190624RH	.037 (.022-.047)	.236 (.157-.354)	0.661	0.750	0.250	0.094
CNMM856RH	CNMM250724RH	.037 (.022-.047)	.315 (.197-.472)	0.917	1.000	0.313	0.094
CNMM866RH	CNMM250924RH	.037 (.022-.047)	.315 (.197-.472)	0.917	1.000	0.375	0.094

For use in holders MCLNR/L, TCKNR/L, TCLNR/L, TCMNN, TCRNR/L, S-MCLNR/L, A-TCLNR/L, see pages 1116, 1084, 1086, 1088, 1089, 1116, 1137.

Part Number	Grade										
	TT5100	TT7100	TT8115	TT8125	TT9225	TT9235					
CNMM432RH			●	●							
CNMM432RH(N)	●		●	●							
CNMM433RH	●		●	●							
CNMM542RH											
CNMM543RH	●		●	●							
CNMM544RH	●		●	●							
CNMM642RH				●							
CNMM643RH	●	●	●	●	●	●					
CNMM643RH(N)	●										
CNMM644RH	●		●	●	●	●					
CNMM644RH(N)	●		●								
CNMM646RH	●		●	●	●	●					
CNMM856RH											
CNMM866RH	●		●								

● = P ● = M ● = K ● = N ● = S ○ = H

TOTURN™ DNGG ML CHIPBREAKER

NEGATIVE 55 DEGREE RHOMBIC GROUND INSERT FOR MEDIUM LIGHT MACHINING/VERY SHARP

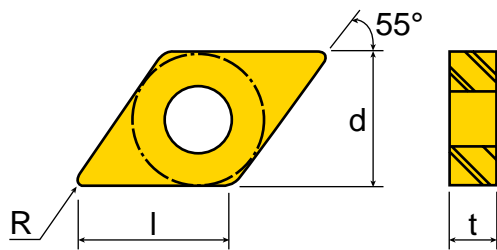

ANSI Number	ISO Number	feed (ipr)	ap (inch)	l	d	t	R	Grade	K10	T15030	T19030		
DNGG431ML	DNGG150404ML	.007 (.004-.012)	.047 (.031-.138)	0.594	0.500	0.187	0.016		●	●			
DNGG432ML	DNGG150408ML	.010 (.005-.014)	.059 (.039-.138)	0.579	0.500	0.187	0.031		●	●	●		

For use in holders MDJNR/L, MDQNR/L, TDJNR/L, TDNNN, TDQNR/L, A-TDUNR/L, see pages 1050, 1051, 1090, 1091, 1091, 1138.

● = P ● = M ● = K ● = N ● = S ○ = H

TOTURN™ DNMA

NEGATIVE 55 DEGREE RHOMBIC FLAT TOP INSERT FOR ROUGHING

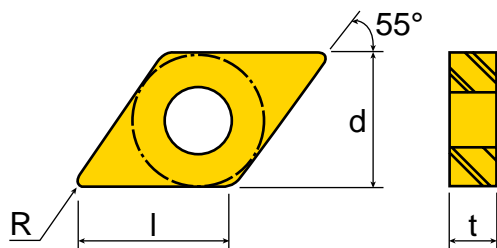
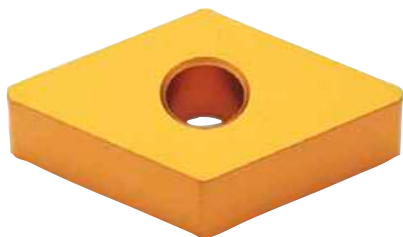

ANSI Number	ISO Number	feed (ipr)	ap (inch)	l	d	t	R	Grade	K10	T11300	T17310		
*DNMA332	DNMA110408	.014 (.006-.020)	.059 (.031-.118)	0.425	0.375	0.187	0.031			●			
*DNMA333	DNMA110412	.017 (.006-.020)	.059 (.031-.118)	0.413	0.375	0.187	0.047			●			
DNMA431	DNMA150404	.012 (.006-.020)	.079 (.016-.157)	0.594	0.500	0.187	0.016						
DNMA432	DNMA150408	.017 (.006-.026)	.079 (.031-.157)	0.579	0.500	0.187	0.031			●	●		
DNMA433	DNMA150412	.020 (.006-.026)	.079 (.047-.157)	0.567	0.500	0.187	0.047			●	●		
DNMA441	DNMA150604	.012 (.006-.020)	.079 (.016-.157)	0.594	0.500	0.250	0.016	●					
DNMA442	DNMA150608	.017 (.006-.026)	.079 (.031-.157)	0.579	0.500	0.250	0.031			●	●		
DNMA443	DNMA150612	.020 (.006-.026)	.079 (.047-.157)	0.567	0.500	0.250	0.047			●	●		

*Insert is screw held

For use in holders MDJNR/L, MDQNR/L, SDJNR/L, TDJNR/L, TDNNN, TDQNR/L, A-SDQNR/L, A-SDUNR/L, A-TDUNR/L, see pages 1050, 1051, 1069, 1090, 1091, 1129, 1138.

● = P ● = M ● = K ● = N ● = S ○ = H

TOTURN™ DNMG COMMON CHIPBREAKER

NEGATIVE 55 DEGREE RHOMBIC INSERTS FOR MEDIUM ROUGHING

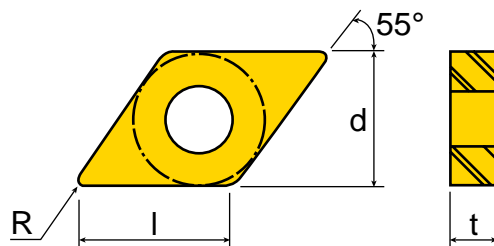
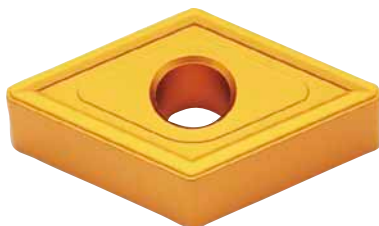

ANSI Number	ISO Number	feed (ipr)	ap (inch)	l	d	t	R
DNMG431	DNMG150404	.011 (.007-.018)	.079 (.039-.157)	0.594	0.500	0.187	0.016
DNMG432	DNMG150408	.015 (.007-.022)	.098 (.059-.157)	0.579	0.500	0.187	0.031
DNMG433	DNMG150412	.018 (.010-.022)	.098 (.059-.157)	0.567	0.500	0.187	0.047
DNMG434	DNMG150416	.022 (.010-.026)	.118 (.098-.157)	0.551	0.500	0.187	0.063
DNMG441	DNMG150604	.011 (.007-.018)	.079 (.039-.157)	0.594	0.500	0.250	0.016
DNMG442	DNMG150608	.015 (.007-.022)	.098 (.059-.157)	0.579	0.500	0.250	0.031
DNMG443	DNMG150612	.018 (.010-.022)	.098 (.059-.157)	0.567	0.500	0.250	0.047
DNMG444	DNMG150616	.022 (.010-.026)	.118 (.098-.157)	0.551	0.500	0.250	0.063

For use in holders MDJNR/L, MDQNR/L, TDJNR/L, TDNN, TDQNR/L, A-TDUNR/L, see pages 1050, 1051, 1090, 1091, 1138.

Part Number	Grade	CT3000	K20	TT1300	TT5100	TT7310	TT8115	TT8125										
DNMG431					●		●	●										
DNMG432				●	●	●	●	●										
DNMG433				●	●		●											
DNMG434					●													
DNMG441		●		●	●		●	●										
DNMG442		●	●	●	●	●	●	●										
DNMG443			●	●	●	●	●	●										
DNMG444							●											

● = P ● = M ● = K ● = N ● = S ○ = H

TOTURN™ DNMG FA CHIPBREAKER

NEGATIVE 55 DEGREE RHOMBIC INSERTS FOR SUPER FINISHING

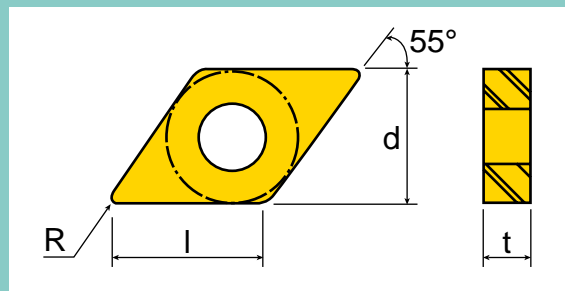

ANSI Number	ISO Number	feed (ipr)	ap (inch)	l	d	t	R	Grade	CT3000	TF5100	TT8115	TT8125
DNMG432FA	DNMG150408FA	.005 (.002-.008)	.016 (.008-.080)	0.579	0.500	0.187	0.031		●	●	●	
DNMG442FA	DNMG150608FA	.005 (.002-.008)	.016 (.008-.080)	0.579	0.500	0.250	0.031					●

For use in holders MDJNR/L, MDQNR/L, TDJNR/L, TDNNN, TDQNR/L, A-TDUNR/L, see [pages 1050, 1051, 1090, 1091, 1138](#).

● = P ● = M ● = K ● = N ● = S ○ = H

TOTURN™ DNMG FC CHIPBREAKER

NEGATIVE 55 DEGREE RHOMBIC INSERTS FOR FINISHING

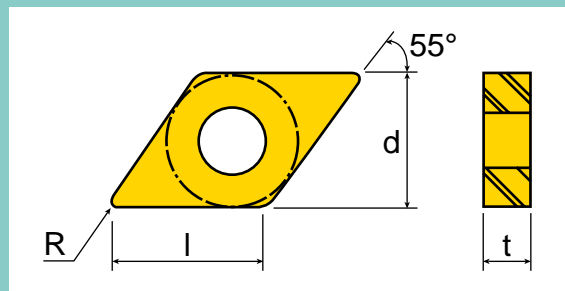
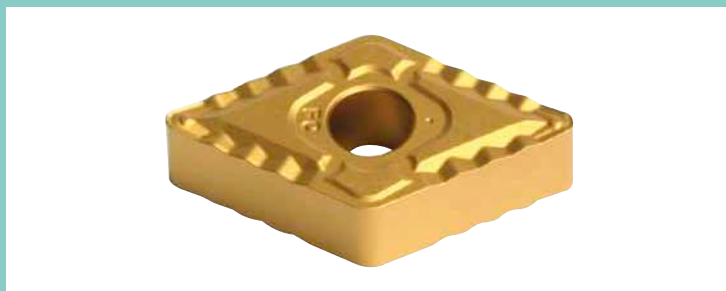

ANSI Number	ISO Number	feed (ipr)	ap (inch)	l	d	t	R
*DNMG331FC	DNMG110404FC	.004 (.003-.008)	.031 (.020-.079)	0.441	0.375	0.187	0.016
*DNMG332FC	DNMG110408FC	.006 (.004-.010)	.039 (.028-.079)	0.425	0.375	0.187	0.031
DNMG431FC	DNMG150404FC	.003 (.001-.011)	.019 (.005-.059)	0.594	0.500	0.187	0.016
DNMG432FC	DNMG150408FC	.007 (.001-.011)	.019 (.009-.078)	0.578	0.500	0.187	0.031
DNMG441FC	DNMG150604FC	.003 (.001-.011)	.019 (.005-.059)	0.594	0.500	0.250	0.016
DNMG442FC	DNMG150608FC	.007 (.001-.011)	.019 (.009-.078)	0.578	0.500	0.250	0.031

For use in holders MDJNR/L, MDQNR/L, SDJNR/L, TDJNR/L, TDNNN, TDQNR/L, A-SDQNR/L, A-SDUNR/L, A-TDUNR/L, see [pages 1050, 1051, 1069, 1090, 1091, 1129, 1138](#).

Part Number	Grade	CT3000	PV3010	TF5100	TT8115	TT8125	TT9215	TT9225	TT9235
DNMG331FC									
DNMG332FC					●	●		●	
DNMG431FC		●		●	●	●		●	
DNMG432FC		●		●	●		●	●	
DNMG441FC						●		●	●
DNMG442FC			●			●	●	●	●

*Insert is screw held

● = P ● = M ● = K ● = N ● = S ○ = H

TOTURN™ DNMG FG CHIPBREAKER

NEGATIVE 55 DEGREE RHOMBIC INSERTS FOR FINISHING

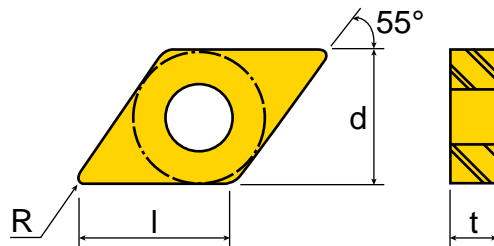

ANSI Number	ISO Number	feed (ipr)	ap (inch)	l	d	t	R
*DNMG331FG	DNMG110404FG	.004 (.003-.008)	.031 (.020-.079)	0.441	0.375	0.187	0.016
*DNMG332FG	DNMG110408FG	.006 (.004-.010)	.039 (.028-.079)	0.425	0.375	0.187	0.031
DNMG431FG	DNMG150404FG	.004 (.003-.008)	.031 (.020-.079)	0.594	0.500	0.187	0.016
DNMG432FG	DNMG150408FG	.006 (.004-.010)	.039 (.028-.079)	0.579	0.500	0.187	0.031
DNMG433FG	DNMG150412FG	.007 (.005-.010)	.047 (.039-.079)	0.567	0.500	0.187	0.047
DNMG441FG	DNMG150604FG	.004 (.003-.008)	.031 (.020-.079)	0.594	0.500	0.250	0.016
DNMG442FG	DNMG150608FG	.006 (.004-.010)	.039 (.028-.079)	0.579	0.500	0.250	0.031

*Insert is screw held

For use in holders MDJNR/L, MDQNR/L, SDJNR/L, TDJNR/L, TDNN, TDQNR/L, A-SDQNR/L, A-SDUNR/L, A-TDUNR/L, see pages 1050, 1051, 1069, 1090, 1091, 1129, 1138.

Part Number	Grade	CT3000	PV3010	TT5030	TT5100	TT8020	TT8115	TT8125											
DNMG331FG		●	●	●	●		●	●											
DNMG332FG		●	●	●	●		●	●											
DNMG431FG		●	●	●	●	●	●	●											
DNMG432FG		●	●		●		●	●											
DNMG433FG							●	●											
DNMG441FG		●	●		●		●	●											
DNMG442FG		●	●		●		●	●											

● = P ● = M ● = K ● = N ● = S ○ = H

TOTURN™ DNMG MC CHIPBREAKER

NEGATIVE 55 DEGREE RHOMBIC INSERTS FOR MEDIUM MACHINING / NEGATIVE RAKE ANGLE

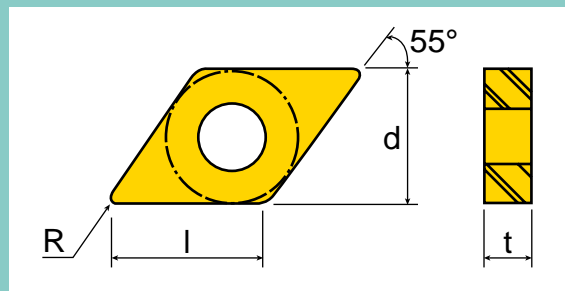

ANSI Number	ISO Number	feed (ipr)	ap (inch)	l	d	t	R	Grade					
								T15100	T7100	T18020	T18115	T18125	
DNMG432MC	DNMG150408MC	.012 (.004-.016)	.059 (.028-.138)	0.579	0.500	0.187	0.031	●				●	●
DNMG433MC	DNMG150412MC	.012 (.006-.014)	.059 (.039-.138)	0.567	0.500	0.187	0.047					●	
DNMG441MC	DNMG150604MC	.008 (.004-.012)	.059 (.020-.138)	0.594	0.500	0.250	0.016	●				●	●
DNMG442MC	DNMG150608MC	.012 (.005-.014)	.059 (.028-.138)	0.579	0.500	0.250	0.031	●	●	●		●	●
DNMG443MC	DNMG150612MC	.012 (.006-.014)	.059 (.039-.138)	0.567	0.500	0.250	0.047	●					

For use in holders MDJNR/L, MDQNR/L, TDJNR/L, TDNNN, TDQNR/L, A-TDUNR/L, see pages 1050, 1051, 1090, 1091, 1138.

● = P ● = M ● = K ● = N ● = S ○ = H

TOTURN™ DNMG ML CHIPBREAKER

NEGATIVE 55 DEGREE RHOMBIC INSERTS FOR MEDIUM LIGHT MACHINING / VERY POSITIVE RAKE ANGLE

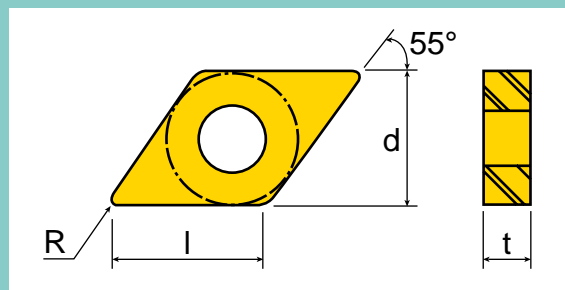

ANSI Number	ISO Number	feed (ipr)	ap (inch)	l	d	t	R
DNMG431ML	DNMG150404ML	.007 (.004-.012)	.047 (.031-.138)	0.594	0.500	0.187	0.016
DNMG432ML	DNMG150408ML	.010 (.005-.014)	.059 (.039-.138)	0.579	0.500	0.187	0.031
DNMG441ML	DNMG150604ML	.007 (.004-.012)	.047 (.031-.138)	0.594	0.500	0.250	0.016
DNMG442ML	DNMG150608ML	.010 (.005-.014)	.059 (.039-.138)	0.579	0.500	0.250	0.031

For use in holders MDJNR/L, MDQNR/L, TDJNR/L, TDNNN, TDQNR/L, A-TDUNR/L, see pages 1050, 1051, 1090, 1091, 1138.

Part Number	Grade	K10	T15030	T15100	T17100	T18020	T18115	T18125	T19215	T19225							
		DNMG431ML		●	●				●	●	●	●					
DNMG432ML		●	●	●		●	●	●	●	●							
DNMG441ML		●	●				●	●									
DNMG442ML		●	●		●	●	●	●									

● = P ● = M ● = K ● = N ● = S ○ = H

TOTURN™ DNMG MP CHIPBREAKER

NEGATIVE 55 DEGREE RHOMBIC INSERTS FOR MEDIUM MACHINING/POSITIVE RAKE ANGLE

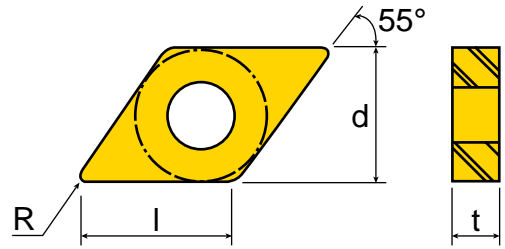

ANSI Number	ISO Number	feed (ipr)	ap (inch)	l	d	t	R
DNMG431MP	DNMG150404MP	.008 (.004-.012)	.059 (.031-.157)	0.594	0.500	0.187	0.016
DNMG432MP	DNMG150408MP	.012 (.005-.016)	.079 (.039-.157)	0.579	0.500	0.187	0.031
DNMG441MP	DNMG150604MP	.008 (.004-.012)	.059 (.031-.157)	0.594	0.500	0.250	0.016
DNMG442MP	DNMG150608MP	.012 (.005-.016)	.079 (.039-.157)	0.579	0.500	0.250	0.031
DNMG443MP	DNMG150612MP	.014 (.006-.016)	.079 (.039-.157)	0.567	0.500	0.250	0.047

For use in holders MDJNR/L, MDQNR/L, TDJNR/L, TDNN, TDQNR/L, A-TDUNR/L, see pages 1050, 1051, 1090, 1091, 1138.

Part Number	Grade	TT5030	TT5100	TT8020	TT8115	TT8125	TT9215	TT9225	TT9235										
DNMG431MP		●	●	●	●		●	●											
DNMG432MP		●	●	●	●	●	●	●	●										
DNMG441MP		●	●		●	●			●										
DNMG442MP		●	●	●	●	●	●	●	●										
DNMG443MP		●	●				●	●	●										

● = P ● = M ● = K ● = N ● = S ○ = H

TOTURN™ DNMG MT CHIPBREAKER

NEGATIVE 55 DEGREE RHOMBIC INSERTS FOR MEDIUM ROUGHING/TOUGH RAKE ANGLE

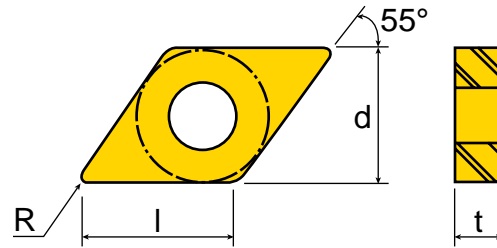

ANSI Number	ISO Number	feed (ipr)	ap (inch)	l	d	t	R
*DNMG332MT	DNMG110408MT	.012 (.007-.016)	.059 (.039-.118)	0.425	0.375	0.187	0.031
*DNMG333MT	DNMG110412MT	.014 (.008-.018)	.059 (.039-.118)	0.413	0.375	0.187	0.047
DNMG431MT	DNMG150404MT	.010 (.006-.016)	.079 (.031-.157)	0.594	0.500	0.187	0.016
DNMG432MT	DNMG150408MT	.014 (.007-.020)	.098 (.039-.157)	0.579	0.500	0.187	0.031
DNMG433MT	DNMG150412MT	.017 (.008-.020)	.098 (.051-.157)	0.567	0.500	0.187	0.047
DNMG441MT	DNMG150604MT	.010 (.006-.016)	.079 (.031-.157)	0.594	0.500	0.250	0.016
DNMG442MT	DNMG150608MT	.014 (.007-.020)	.098 (.039-.157)	0.579	0.500	0.250	0.031
DNMG443MT	DNMG150612MT	.017 (.008-.020)	.098 (.051-.157)	0.567	0.500	0.250	0.047

*Insert is screw held

For use in holders MDJNR/L, MDQNR/L, SDJNR/L, TDJNR/L, TDNN, TDQNR/L, A-SDQNR/L, A-SDUNR/L, A-TDUNR/L, see pages 1050, 1051, 1069, 1090, 1091, 1129, 1138.

Part Number	Grade	CT3000	TT1300	TT5030	TT5100	TT7100	TT7310	TT8020	TT8115	TT8125	TT9030	TT9215	TT9225	TT9235
DNMG332MT		●	●	●	●		●		●	●				
DNMG333MT					●				●					
DNMG431MT		●	●				●		●	●				
DNMG432MT		●	●	●	●		●	●	●	●	●	●	●	●
DNMG433MT					●				●					
DNMG441MT		●	●	●	●		●		●	●				
DNMG442MT		●	●	●	●	●	●	●	●	●	●	●	●	●
DNMG443MT			●	●	●		●	●	●	●	●	●	●	●

● = P ● = M ● = K ● = N ● = S ○ = H

TOTURN™ DNMG PC CHIPBREAKER

NEGATIVE 55 DEGREE RHOMBIC INSERTS FOR MEDIUM MACHINING

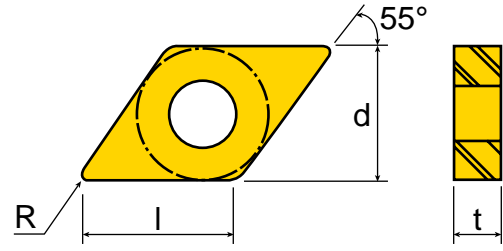

ANSI Number	ISO Number	feed (ipr)	ap (inch)	l	d	t	R
*DNMG332PC	DNMG110408PC	.012 (.007-.016)	.059 (.038-.118)	0.425	0.375	0.187	0.031
DNMG431PC	DNMG150404PC	.010 (.004-.016)	.079 (.016-.157)	0.594	0.500	0.187	0.016
DNMG432PC	DNMG150408PC	.012 (.006-.020)	.079 (.020-.157)	0.579	0.500	0.187	0.031
DNMG433PC	DNMG150412PC	.014 (.007-.022)	.079 (.024-.157)	0.567	0.500	0.187	0.047
DNMG441PC	DNMG150604PC	.010 (.004-.016)	.079 (.016-.157)	0.594	0.500	0.250	0.016
DNMG442PC	DNMG150608PC	.012 (.006-.020)	.079 (.020-.157)	0.579	0.500	0.250	0.031
DNMG443PC	DNMG150612PC	.014 (.007-.022)	.079 (.024-.157)	0.567	0.500	0.250	0.047

*Insert is screw held

For use in holders MDJNR/L, MDQNR/L, SDJNR/L, TDJNR/L, TDNN, TDQNR/L, A-SDQNR/L, A-SDUNR/L, A-TDUNR/L, see pages 1050, 1051, 1069, 1090, 1091, 1129, 1138.

Part Number	Grade	T15100	T18115	T18125	T19215	T19225	T19235												
DNMG332PC				●															
DNMG431PC		●	●	●	●	●													
DNMG432PC		●	●	●	●	●	●												
DNMG433PC		●	●	●															
DNMG441PC				●	●	●	●												
DNMG442PC				●	●	●	●												
DNMG443PC				●		●	●												

● = P ● = M ● = K ● = N ● = S ○ = H

TOTURN™ DNMG RT CHIPBREAKER

NEGATIVE 55 DEGREE RHOMBIC INSERTS FOR ROUGHING/WIDE, TOUGH RAKE ANGLE

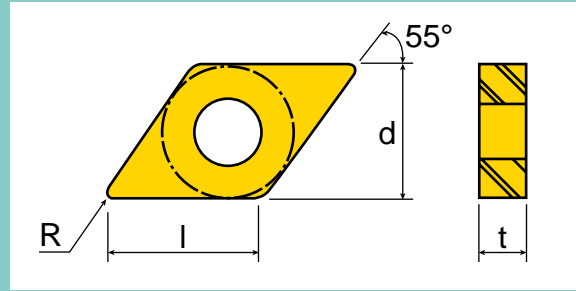
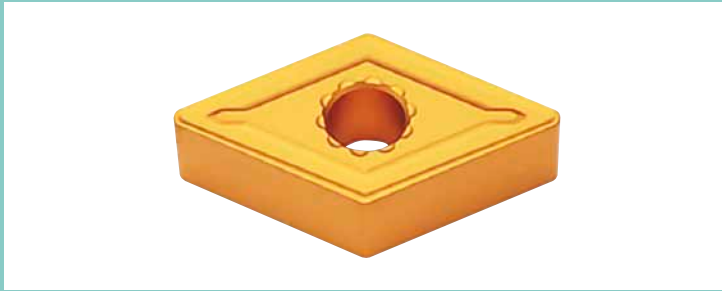

ANSI Number	ISO Number	feed (ipr)	ap (inch)	l	d	t	R	Grade				
								T1300	T5100	T7310	T8115	T8125
DNMG432RT	DNMG150408RT	.017 (.010-.026)	.118 (.079-.157)	0.579	0.500	0.187	0.031	●	●	●	●	●
DNMG433RT	DNMG150412RT	.020 (.010-.026)	.118 (.098-.157)	0.567	0.500	0.187	0.047			●		●
DNMG442RT	DNMG150608RT	.017 (.010-.026)	.118 (.098-.157)	0.579	0.500	0.250	0.031		●	●	●	●
DNMG443RT	DNMG150612RT	.020 (.010-.026)	.118 (.098-.157)	0.567	0.500	0.250	0.047	●		●		●
DNMG444RT	DNMG150616RT	.022 (.010-.028)	.138 (.098-.216)	0.551	0.500	0.250	0.063					●

For use in holders MDJNR/L, MDQNR/L, TDJNR/L, TDNNN, TDQNR/L, A-TDUNR/L, see pages 1050, 1051, 1090, 1091, 1138.

● = P ● = M ● = K ● = N ● = S ○ = H

TOTURN™ DNMG R/L-VF CHIPBREAKER

NEGATIVE 55 DEGREE RHOMBIC INSERTS FOR VIBRATION FREE MACHINING / LOW CUTTING FORCE

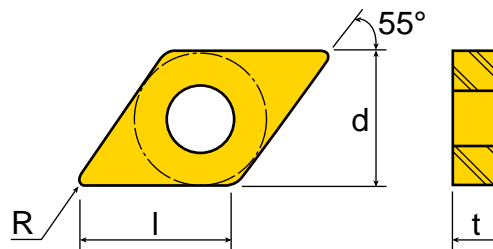

ANSI Number	ISO Number	feed (ipr)	ap (inch)	l	d	t	R
DNMG431L-VF	DNMG150404L-VF	.007 (.004-.014)	.059 (.028-.177)	0.594	0.500	0.187	0.016
DNMG431R-VF	DNMG150404R-VF	.007 (.004-.014)	.059 (.028-.177)	0.594	0.500	0.187	0.016
DNMG432L-VF	DNMG150408L-VF	.009 (.005-.018)	.071 (.039-.177)	0.579	0.500	0.187	0.031
DNMG432R-VF	DNMG150408R-VF	.009 (.005-.018)	.071 (.039-.177)	0.579	0.500	0.187	0.031
DNMG441L-VF	DNMG150604L-VF	.007 (.004-.014)	.059 (.028-.177)	0.594	0.500	0.250	0.016
DNMG441R-VF	DNMG150604R-VF	.007 (.004-.014)	.059 (.028-.177)	0.594	0.500	0.250	0.016
DNMG442L-VF	DNMG150608L-VF	.009 (.005-.018)	.071 (.039-.177)	0.579	0.500	0.250	0.031
DNMG442R-VF	DNMG150608R-VF	.009 (.005-.018)	.071 (.039-.177)	0.579	0.500	0.250	0.031

For use in holders MDJNR/L, MDQNR/L, TDJNR/L, TDNN, TDQNR/L, A-TDUNR/L, see pages 1050, 1051, 1090, 1091, 1138.

Part Number	Grade	CT3000	TT5030	TT5100	TT7100	TT8115	TT8125											
DNMG431L-VF				●			●											
DNMG431R-VF			●	●		●	●											
DNMG432L-VF			●			●												
DNMG432R-VF			●			●	●											
DNMG441L-VF		●		●		●	●											
DNMG441R-VF		●		●	●	●	●											
DNMG442L-VF				●		●	●											
DNMG442R-VF		●		●	●	●	●											

● = P ● = M ● = K ● = N ● = S ○ = H

TOTURN™ DNMG WT CHIPBREAKER

NEGATIVE 55 DEGREE RHOMBIC WIPER INSERTS FOR MEDIUM ROUGHING

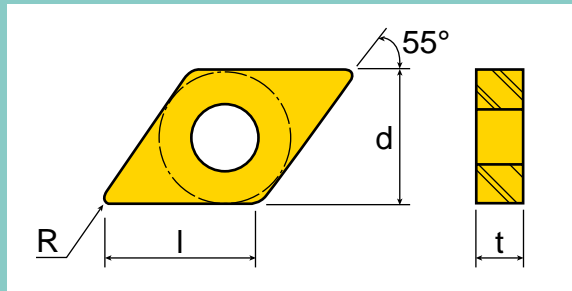

ANSI Number	ISO Number	feed (ipr)	ap (inch)	l	d	t	R	Grade					
								CT3000	TT1300	TT5100	TT8115		
DNMG433WT	DNMG150412WT	.018 (.006-.024)	.079 (.039-.197)	0.567	0.500	0.187	0.047						
DNMG443WT	DNMG150612WT	.018 (.006-.024)	.079 (.039-.197)	0.567	0.500	0.250	0.047						

For use in holders MDJNR/L, MDQNR/L, TDJNR/L, TDNNN, TDQNR/L, A-TDUNR/L, see [pages 1050, 1051, 1090, 1091, 1138](#).

● = P ● = M ● = K ● = N ● = S ○ = H

TOTURN™ HNMG GU CHIPBREAKER

NEGATIVE HEXAGONAL 120 DEGREE INSERTS FOR MEDIUM ROUGHING/TOUGH RAKE ANGLE

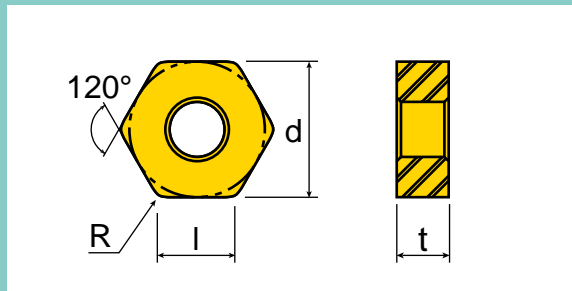

ANSI Number	ISO Number	feed (ipr)	ap (inch)	l	d	t	R
HNMG432GU	HNMG050408GU	.014 (.006-.024)	.078 (.020-.138)	0.244	0.500	0.187	0.031
HNMG643GU	HNMG100612GU	.017 (.014-.028)	.100 (.020-.256)	0.387	0.750	0.250	0.047

For use in holders THSNR/L, THSN QUICK CHANGE, A-THSNR/L, see [pages 1092, 1093, 1139](#).

Part Number	Grade						
	TT1300	TT5100	TT7100	TT7310	TT8125	TT9215	
HNMG432GU	●	●		●	●	●	
HNMG643GU	●	●	●	●	●		

● = P ● = M ● = K ● = N ● = S ○ = H

TOTURN™ HNMG SU CHIPBREAKER

NEGATIVE HEXAGONAL 120 DEGREE INSERTS FOR MEDIUM MACHINING/POSITIVE RAKE ANGLE

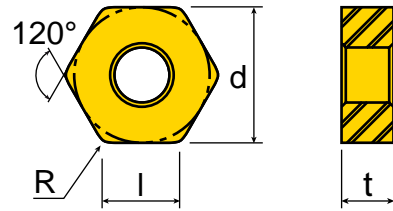

ANSI Number	ISO Number	feed (ipr)	ap (inch)	l	d	t	R	Grade	TT5030	TT5100				
HNMG432SU	HNMG050408SU	.010 (.006-.020)	.060 (.020-.138)	0.244	0.500	0.187	0.031		●	●				
HNMG643SU	HNMG100612SU	.018 (.010-.028)	.100 (.020-.256)	0.387	0.750	0.250	0.047		●	●				

For use in holders THSNR/L, THSN QUICK CHANGE, A-THSNR/L, see pages 1092, 1093, 1139.

● = P ● = M ● = K ● = N ● = S ○ = H

TOTURN™ KNUX R/L 11 CHIPBREAKER

NEGATIVE 55 DEGREE RHOMBIC INSERTS FOR MEDIUM MACHINING IN PROFILING

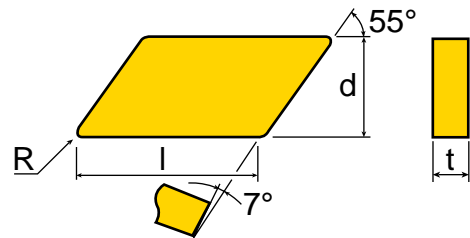

ANSI Number	ISO Number	feed (ipr)	ap (inch)	l	d	t	R
KNUX3331L11	KNUX160405L11	.012 (.006-.014)	.098 (.059-.197)	0.756	0.375	0.187	0.020
KNUX3331R11	KNUX160405R11	.012 (.006-.014)	.098 (.059-.197)	0.756	0.375	0.187	0.020
KNUX3332L11	KNUX160410L11	.014 (.008-.018)	.138 (.079-.197)	0.740	0.375	0.187	0.039
KNUX3332R11	KNUX160410R11	.014 (.008-.018)	.138 (.079-.197)	0.740	0.375	0.187	0.039

For use in holders CKJNR/L, CKNNR, S-CKUNR/L, see pages 1042, 1043, 1114.

Part Number	Grade	CT3000	P20	TT1300	TT5100	TT7100	TT8020	TT8115	TT8125	TT9225							
KNUX3331L11					●			●	●	●							
KNUX3331R11		●	●		●	●	●	●	●	●							
KNUX3332L11								●	●	●							
KNUX3332R11				●				●	●	●							

● = P ● = M ● = K ● = N ● = S ○ = H

TOTURN™ KNUX R/L 12 CHIPBREAKER

NEGATIVE 55 DEGREE RHOMBIC INSERTS FOR MEDIUM ROUGHING IN PROFILING

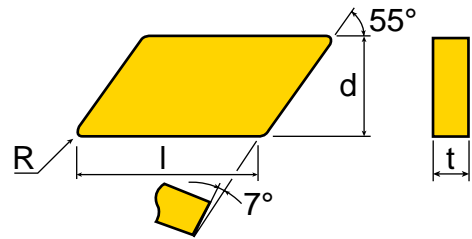

ANSI Number	ISO Number	feed (ipr)	ap (inch)	l	d	t	R	Grade			
								T15100	T18115	T18125	T19225
KNUX3331L12	KNUX160405L12	.014 (.009-.020)	.098 (.079-.197)	0.756	0.375	0.187	0.020	●	●	●	●
KNUX3331R12	KNUX160405R12	.014 (.009-.020)	.098 (.079-.197)	0.756	0.375	0.187	0.020	●	●	●	●
KNUX3332L12	KNUX160410L12	.017 (.012-.024)	.138 (.098-.236)	0.740	0.375	0.187	0.039	●	●	●	●
KNUX3332R12	KNUX160410R12	.017 (.012-.024)	.138 (.098-.236)	0.740	0.375	0.187	0.039	●	●	●	●

For use in holders CKJNR/L, CKNNR, S-CKUNR/L, see pages 1042, 1043, 1114.

● = P ● = M ● = K ● = N ● = S ○ = H

TOTURN™ RNMG COMMON CHIPBREAKER

NEGATIVE ROUND INSERTS FOR MEDIUM ROUGHING

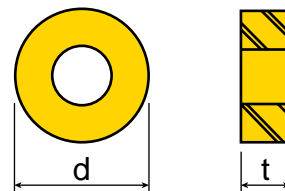

ANSI Number	ISO Number	feed (ipr)	ap (inch)	l	d	t	R	Grade				
								T15030	T15100	T17100	T18115	T18125
RNMG43	RNMG120400	.018 (.012-.024)	.118 (.079-.197)	-	0.500	0.187	-	●	●	●	●	●
RNMG86	RNMG250900	.033 (.022-.047)	.236 (.157-.472)	-	1.000	0.375	-	●	●	●	●	●

For use in holder MRGMR/L, see page 1052.

● = P ● = M ● = K ● = N ● = S ○ = H

TOTURN™ SNGG R/L CHIPBREAKER

NEGATIVE SQUARE GROUND INSERTS FOR MEDIUM LIGHT MACHINING

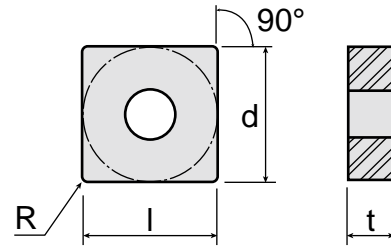

ANSI Number	ISO Number	feed (ipr)	ap (inch)	I	d	t	R	Grade	CT3000	P20			
SNGG321L	SNGG090304L	.007 (.005-.014)	.059 (.039-.118)	0.358	0.375	0.125	0.016						
SNGG322L	SNGG090308L	.009 (.006-.014)	.059 (.039-.118)	0.343	0.375	0.125	0.031						
SNGG322R	SNGG090308R	.010 (.006-.016)	.059 (.039-.118)	0.343	0.375	0.125	0.031						
SNGG431L	SNGG120404L	.008 (.006-.014)	.118 (.039-.157)	0.484	0.500	0.187	0.016						
SNGG431R	SNGG120404R	.007 (.005-.014)	.079 (.039-.157)	0.484	0.500	0.187	0.016						
SNGG432L	SNGG120408L	.009 (.006-.016)	.079 (.039-.157)	0.469	0.500	0.187	0.031						
SNGG432R	SNGG120408R	.010 (.006-.014)	.118 (.039-.157)	0.469	0.500	0.187	0.031						

For use in holders MSDNN, MSRNR/L, MSSNR/L, TSDNN, TSKNR/L, TSRNR/L, TSSNR/L, S-MSKNR/L. See pages 1053 - 1055, 1094 - 1097, 1118.

● = P ● = M ● = K ● = N ● = S ○ = H

TOTURN™ SNMA

NEGATIVE SQUARE FLAT TOP INSERTS FOR ROUGHING

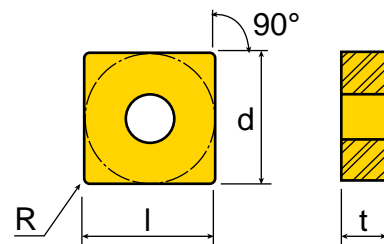
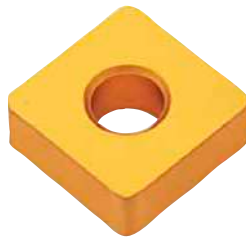

ANSI Number	ISO Number	feed (ipr)	ap (inch)	I	d	t	R	Grade	K10	T1300	T7310	T8115
SNMA432	SNMA120408	.018 (.006-.028)	.118 (.039-.236)	0.469	0.500	0.187	0.031					
SNMA433	SNMA120412	.022 (.010-.031)	.118 (.059-.236)	0.453	0.500	0.187	0.047					
SNMA434	SNMA120416	.026 (.012-.039)	.118 (.079-.236)	0.437	0.500	0.187	0.063					
SNMA543	SNMA150612	.022 (.010-.031)	.157 (.079-.315)	0.575	0.625	0.250	0.047					
SNMA544	SNMA150616	.022 (.012-.039)	.149 (.079-.315)	0.559	0.625	0.250	0.063					
SNMA643	SNMA190612	.022 (.010-.031)	.236 (.079-.394)	0.701	0.750	0.250	0.047					
SNMA644	SNMA190616	.026 (.012-.039)	.236 (.079-.394)	0.685	0.750	0.250	0.063					
SNMA854	SNMA250716	.026 (.012-.040)	.315 (.118-.512)	0.937	1.000	0.313	0.063					
SNMA856	SNMA250724	.037 (.016-.047)	.315 (.118-.512)	0.906	1.000	0.313	0.094					

For use in holders MSDNN, MSRNR/L, MSSNR/L, TSDNN, TSKNR/L, TSRNR/L, TSSNR/L, S-MSKNR/L. See pages 1053 - 1055, 1094 - 1097, 1118.

● = P ● = M ● = K ● = N ● = S ○ = H

TOTURN™ SNMG COMMON CHIPBREAKER

NEGATIVE SQUARE INSERTS FOR MEDIUM ROUGHING

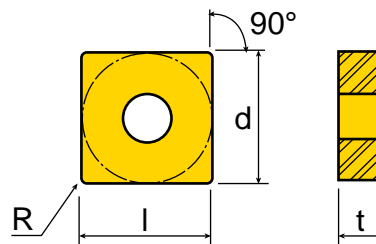

ANSI Number	ISO Number	feed (ipr)	ap (inch)	l	d	t	R
SNMG321	SNMG090304	.011 (.007-.018)	.059 (.031-.138)	0.358	0.375	0.125	0.016
SNMG322	SNMG090308	.016 (.008-.020)	.079 (.039-.138)	0.343	0.375	0.125	0.031
SNMG431	SNMG120404	.011 (.007-.018)	.118 (.039-.197)	0.484	0.500	0.187	0.016
SNMG432	SNMG120408	.016 (.009-.024)	.118 (.059-.197)	0.469	0.500	0.187	0.031
SNMG433	SNMG120412	.020 (.010-.024)	.118 (.079-.197)	0.453	0.500	0.187	0.047
SNMG434	SNMG120416	.022 (.014-.028)	.118 (.098-.197)	0.437	0.500	0.187	0.063
SNMG542	SNMG150608	.016 (.010-.024)	.157 (.079-.236)	0.591	0.625	0.250	0.031
SNMG543	SNMG150612	.020 (.010-.024)	.157 (.079-.236)	0.575	0.625	0.250	0.047
SNMG544	SNMG150616	.022 (.014-.028)	.157 (.079-.236)	0.559	0.625	0.250	0.063
SNMG641	SNMG190604	.011 (.007-.018)	.197 (.118-.315)	0.732	0.750	0.250	0.016
SNMG642	SNMG190608	.016 (.010-.024)	.197 (.118-.315)	0.717	0.750	0.250	0.031
SNMG643	SNMG190612	.020 (.012-.024)	.197 (.118-.315)	0.701	0.750	0.250	0.047
SNMG644	SNMG190616	.022 (.014-.028)	.197 (.118-.315)	0.685	0.750	0.250	0.063
SNMG854	SNMG250716	.022 (.014-.028)	.315 (.157-.472)	0.937	1.000	0.313	0.063
SNMG856	SNMG250724	.025 (.020-.039)	.315 (.197-.472)	0.906	1.000	0.313	0.094
SNMG866	SNMG250924	.025 (.020-.039)	.315 (.197-.472)	0.906	1.000	0.375	0.094

For use in holders MSDNN, MSRR/L, MSSNR/L, TSDNN, TSKNR/L, TSRNR/L, TSSNR/L, S-MSKNR/L.
See pages 1053 - 1055, 1094 - 1097, 1118.

Part Number	Grade	CT3000	K20	P20	TT1300	TT5100	TT7100	TT7310	TT8020	TT8115	TT8125							
SNMG321		●			●	●				●	●							
SNMG322		●				●				●	●							
SNMG431				●	●	●	●	●		●	●							
SNMG432			●		●	●	●	●	●	●	●							
SNMG433					●	●		●		●	●							
SNMG434						●					●							
SNMG542						●					●							
SNMG543											●							
SNMG544						●												
SNMG641											●							
SNMG642					●	●		●		●	●							
SNMG643					●	●	●	●		●	●							
SNMG644						●					●							
SNMG854						●					●							
SNMG856						●					●							
SNMG866							●				●							

● = P ● = M ● = K ● = N ● = S ○ = H

TOTURN™ SNMG FG CHIPBREAKER

NEGATIVE SQUARE INSERTS FOR FINISHING

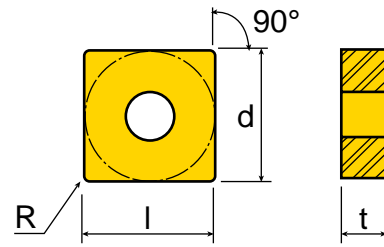
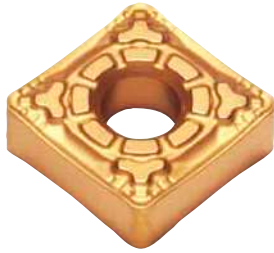

ANSI Number	ISO Number	feed (ipr)	ap (inch)	l	d	t	R
SNMG321FG	SNMG090304FG	.004 (.003-.008)	.031 (.020-.079)	0.358	0.500	0.125	0.016
SNMG322FG	SNMG090308FG	.006 (.004-.010)	.039 (.028-.079)	0.343	0.500	0.125	0.031
SNMG431FG	SNMG120404FG	.004 (.003-.008)	.031 (.020-.118)	0.484	0.500	0.187	0.016
SNMG432FG	SNMG120408FG	.006 (.004-.010)	.039 (.028-.118)	0.469	0.500	0.187	0.031

For use in holders MSDNN, MSRNR/L, MSSNR/L, TSDNN, TSKNR/L, TSRNR/L, TSSNR/L, S-MSKNR/L.
See pages 1053 - 1055, 1094 - 1097, 1118.

Part Number	Grade	CT3000	PV3010	TT5030	TT5100	TT8115	TT8125	TT9215									
SNMG321FG						●											
SNMG322FG			●	●	●		●	●									
SNMG431FG		●	●		●		●										
SNMG432FG			●		●	●	●										

● = P ● = M ● = K ● = N ● = S ○ = H

TOTURN™ SNMG MC CHIPBREAKER

NEGATIVE SQUARE INSERTS FOR MEDIUM MACHINING / NEGATIVE RAKE ANGLE

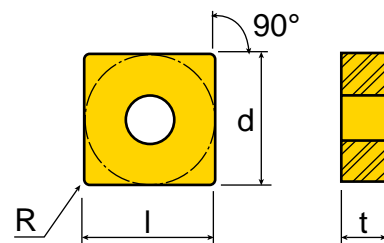

ANSI Number	ISO Number	feed (ipr)	ap (inch)	l	d	t	R	Grade	TT5100	TT8115	TT8125					
SNMG432MC	SNMG120408MC	.012 (.005-.014)	.059 (.028-.138)	0.469	0.500	0.187	0.031		●	●	●					
SNMG433MC	SNMG120412MC	.014 (.006-.016)	.059 (.028-.138)	0.453	0.500	0.187	0.047		●	●	●					

For use in holders MSDNN, MSRNR/L, MSSNR/L, TSDNN, TSKNR/L, TSRNR/L, TSSNR/L, S-MSKNR/L.
See pages 1053 - 1055, 1094 - 1097, 1118.

● = P ● = M ● = K ● = N ● = S ○ = H

TOTURN™ SNMG ML CHIPBREAKER

NEGATIVE SQUARE INSERTS FOR MEDIUM LIGHT MACHINING / VERY POSITIVE RAKE ANGLE

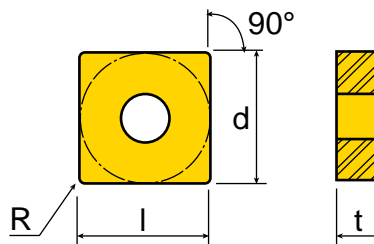

ANSI Number	ISO Number	feed (ipr)	ap (inch)	l	d	t	R	Grade			
								T15100	T18020	T18115	T18125
SNMG432ML	SNMG120408ML	.010 (.005-.014)	.059 (.039-.138)	0.469	0.500	0.187	0.031	●	●	●	●
SNMG433ML	SNMG120412ML	.012 (.006-.014)	.079 (.051-.138)	0.453	0.500	0.187	0.047	●	●	●	●

For use in holders MSDNN, MSRNR/L, MSSNR/L, TSDNN, TSKNR/L, TSRNR/L, TSSNR/L, S-MSKNR/L.
See pages 1053 - 1055, 1094 - 1097, 1118.

● = P ● = M ● = K ● = N ● = S ○ = H

TOTURN™ SNMG MP CHIPBREAKER

NEGATIVE SQUARE INSERTS FOR MEDIUM MACHINING/POSITIVE RAKE ANGLE

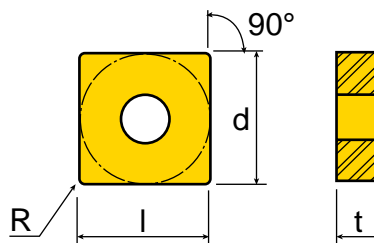

ANSI Number	ISO Number	feed (ipr)	ap (inch)	l	d	t	R
SNMG431MP	SNMG120404MP	.008 (.004-.012)	.079 (.031-.157)	0.484	0.500	0.187	0.016
SNMG432MP	SNMG120408MP	.012 (.005-.016)	.079 (.039-.157)	0.469	0.500	0.187	0.031
SNMG433MP	SNMG120412MP	.014 (.006-.016)	.079 (.051-.157)	0.453	0.500	0.187	0.047

For use in holders MSDNN, MSRNR/L, MSSNR/L, TSDNN, TSKNR/L, TSRNR/L, TSSNR/L, S-MSKNR/L.
See pages 1053 - 1055, 1094 - 1097, 1118.

Part Number	Grade	T15030	T15100	T18020	T18115	T18125	T19215	T19225	T19235
SNMG431MP		●	●	●	●	●			
SNMG432MP		●	●	●	●	●	●	●	●
SNMG433MP		●	●	●	●	●	●	●	●

● = P ● = M ● = K ● = N ● = S ○ = H

TOTURN™ SNMG MT CHIPBREAKER

NEGATIVE SQUARE INSERTS FOR MEDIUM ROUGHING/ TOUGH RAKE ANGLE

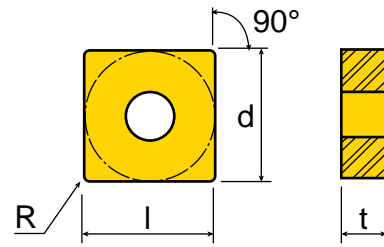

ANSI Number	ISO Number	feed (ipr)	ap (inch)	l	d	t	R
SNMG322MT	SNMG090308MT	.014 (.007-.020)	.079 (.039-.138)	0.343	0.375	0.125	0.031
SNMG431MT	SNMG120404MT	.010 (.005-.016)	.118 (.039-.197)	0.484	0.500	0.187	0.016
SNMG432MT	SNMG120408MT	.014 (.007-.022)	.118 (.047-.197)	0.469	0.500	0.187	0.031
SNMG433MT	SNMG120412MT	.017 (.008-.022)	.118 (.059-.197)	0.453	0.500	0.187	0.047
SNMG543MT	SNMG150612MT	.017 (.010-.022)	.157 (.078-.275)	0.575	0.625	0.250	0.047
SNMG642MT	SNMG190608MT	.014 (.008-.022)	.197 (.118-.315)	0.717	0.750	0.250	0.031
SNMG643MT	SNMG190612MT	.017 (.010-.022)	.197 (.118-.315)	0.701	0.750	0.250	0.047

For use in holders MSDNN, MSNR/L, MSSNR/L, TSDNN, TSKNR/L, TSRNR/L, TSSNR/L, S-MSKNR/L.
See pages 1053 - 1055, 1094 - 1097, 1118.

Part Number	Grade	CT3000	T1300	T5030	T5100	T7310	T8020	T8115	T8125	T9030	T9215	T9225	T9235						
SNMG322MT			●		●			●	●										
SNMG431MT		●			●			●	●										
SNMG432MT		●	●	●	●	●	●	●	●	●		●	●						
SNMG433MT			●	●	●		●	●	●		●	●							
SNMG543MT									●										
SNMG642MT									●			●	●						
SNMG643MT					●		●		●			●	●						

● = P ● = M ● = K ● = N ● = S ○ = H

NEGATIVE SQUARE INSERTS FOR MEDIUM MACHINING

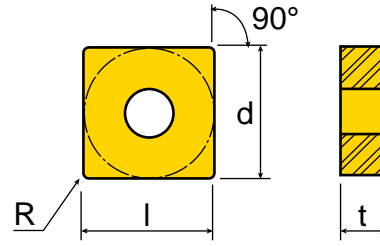

ANSI Number	ISO Number	feed (ipr)	ap (inch)	l	d	t	R	Grade				
								T15100	T18115	T18125	T19225	
SNMG322PC	SNMG090308PC	.006 (.004-.010)	.040 (.028-.079)	0.343	0.375	0.125	0.031				●	
SNMG431PC	SNMG120404PC	.010 (.005-.016)	.100 (.020-.197)	0.484	0.500	0.187	0.016				●	
SNMG432PC	SNMG120408PC	.012 (.006-.020)	.100 (.040-.197)	0.469	0.500	0.187	0.031	●	●	●	●	
SNMG433PC	SNMG120412PC	.012 (.006-.020)	.100 (.040-.197)	0.453	0.500	0.187	0.047				●	●

For use in holders MSDNN, MSRR/L, MSSNR/L, TSDNN, TSKNR/L, TSRNR/L, TSSNR/L, S-MSKNR/L.
See pages 1053 - 1055, 1094 - 1097, 1118.

● = P ● = M ● = K ● = N ● = S ○ = H

TOTURN™ SNMG RT CHIPBREAKER

NEGATIVE SQUARE INSERTS FOR ROUGHING/ WIDE, TOUGH RAKE ANGLE

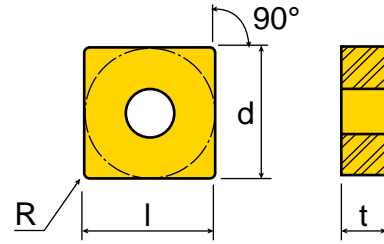

ANSI Number	ISO Number	feed (ipr)	ap (inch)	l	d	t	R
SNMG432RT	SNMG120408RT	.018 (.010-.028)	.157 (.098-.236)	0.469	0.500	0.187	0.031
SNMG433RT	SNMG120412RT	.022 (.012-.028)	.157 (.098-.236)	0.453	0.500	0.187	0.047
SNMG543RT	SNMG150612RT	.022 (.012-.028)	.197 (.118-.276)	0.575	0.625	0.250	0.047
SNMG643RT	SNMG190612RT	.022 (.012-.030)	.236 (.118-.354)	0.701	0.750	0.250	0.047
SNMG644RT	SNMG190616RT	.025 (.018-.035)	.236 (.118-.354)	0.685	0.750	0.250	0.063
SNMG866RT	SNMG250924RT	.031 (.016-.039)	.315 (.197-.472)	0.906	1.000	0.375	0.094

For use in holders MSDNN, MSNR/L, MSSNR/L, TSDNN, TSKNR/L, TSRNR/L, TSSNR/L, S-MSKNR/L.
See pages 1053 - 1055, 1094 - 1097, 1118.

Part Number	Grade	TT1300	TT5030	TT5100	TT7310	TT8020	TT8115	TT8125	TT9215	TT9225	TT9235								
SNMG432RT		●	●	●	●	●	●	●											
SNMG433RT		●			●		●		●		●								
SNMG543RT				●		●		●											
SNMG643RT		●	●	●		●	●	●	●	●	●								
SNMG644RT			●	●		●	●	●		●	●								
SNMG866RT				●				●											

● = P ● = M ● = K ● = N ● = S ○ = H

TOTURN™ SNMM HT CHIPBREAKER

NEGATIVE SQUARE INSERTS FOR HEAVY ROUGHING

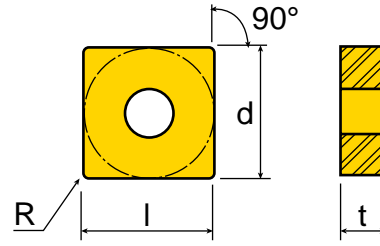
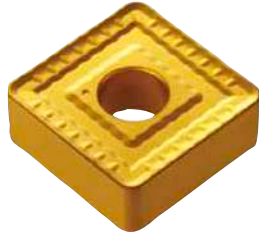

ANSI Number	ISO Number	feed (ipr)	ap (inch)	l	d	t	R	Grade				
								T7100	T8115	T8125	T9225	
SNMM643HT	SNMM190612HT	.024 (.014-.035)	.236 (.157-.354)	0.701	0.750	0.250	0.047				●	
SNMM644HT	SNMM190616HT	.028 (.018-.040)	.236 (.157-.354)	0.685	0.750	0.250	0.063	●			●	
SNMM646HT	SNMM190624HT	.037 (.022-.047)	.236 (.157-.354)	0.654	0.750	0.250	0.094	●	●	●		
SNMM856HT	SNMM250724HT	.040 (.022-.051)	.315 (.197-.472)	0.906	1.000	0.312	0.094				●	●
SNMM866HT	SNMM250924HT	.040 (.022-.051)	.315 (.197-.472)	0.906	1.000	0.375	0.094	●	●	●		
SNMM868HT	SNMM250932HT	.040 (.026-.051)	.354 (.197-.512)	0.875	1.000	0.375	0.126				●	

For use in holders MSDNN, MSRNR/L, TSDNN, TSRNR/L, TSSNR/L,
See pages 1053, 1054, 1094, 1096, 1097.

● = P ● = M ● = K ● = N ● = S ○ = H

TOTURN™ SNMM HY CHIPBREAKER

NEGATIVE SQUARE INSERTS FOR HEAVY ROUGHING

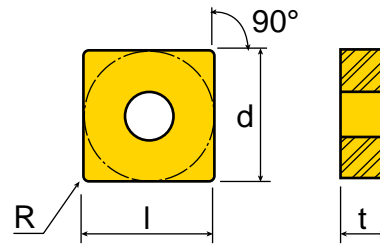
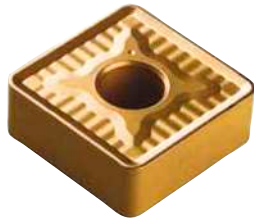

ANSI Number	ISO Number	feed (ipr)	ap (inch)	l	d	t	R	Grade		
								T8115	T8125	
SNMM646HY	SNMM190624	.033 (.020-.043)	.354 (.157-.472)	0.750	0.654	0.250	0.094			●
SNMM866HY	SNMM250924	.040 (.022-.059)	.394 (.157-.591)	0.906	1.000	0.375	0.094	●	●	

For use in holders MSDNN, MSRNR/L, TSDNN, TSRNR/L, TSSNR/L,
See pages 1053, 1054, 1094, 1096, 1097.

● = P ● = M ● = K ● = N ● = S ○ = H



TOTURN™ SNMM HZ CHIPBREAKER

NEGATIVE SQUARE INSERTS FOR HEAVY ROUGHING

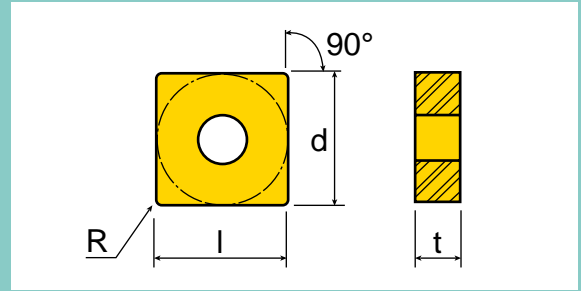

ANSI Number	ISO Number	feed (ipr)	ap (inch)	l	d	t	R	Grade	T8115	T8125			
SNMM866HZ	SNMM250924HZ	.043 (.024-.059)	.394 (.138-.630)	0.906	1.000	0.375	0.094		<input checked="" type="radio"/>	<input checked="" type="radio"/>			

= P = M = K = N = S = H

TOTURN™ SNMM RH&RH(N) CHIPBREAKER

NEGATIVE SQUARE INSERTS FOR HIGH FEED ROUGHING



RH



RH(N)

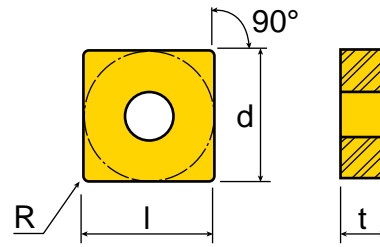

ANSI Number	ISO Number	feed (ipr)	ap (inch)	l	d	t	R
SNMM432RH	SNMM120408RH	.020 (.012-.031)	.157 (.098-.236)	0.469	0.500	0.187	0.031
SNMM432RH(N)	SNMM120408RH(N)	.016 (.010-.028)	.137 (.098-.196)	0.469	0.500	0.187	0.031
SNMM433RH	SNMM120412RH	.025 (.012-.031)	.157 (.098-.236)	0.453	0.500	0.187	0.047
SNMM433RH(N)	SNMM120412RH(N)	.022 (.012-.028)	.137 (.098-.196)	0.453	0.500	0.187	0.047
SNMM434RH	SNMM120416RH	.028 (.018-.039)	.137 (.098-.196)	0.437	0.500	0.187	0.063
SNMM543RH	SNMM150612RH	.025 (.012-.031)	.197 (.118-.275)	0.575	0.625	0.250	0.047
SNMM642RH	SNMM190608RH	.020 (.012-.031)	.236 (.118-.354)	0.717	0.750	0.250	0.031
SNMM643RH	SNMM190612RH	.025 (.012-.031)	.276 (.118-.354)	0.701	0.750	0.250	0.047
SNMM643RH(N)	SNMM190612RH(N)	.022 (.012-.028)	.196 (.118-.314)	0.701	0.750	0.250	0.047
SNMM644RH	SNMM190616RH	.028 (.018-.039)	.236 (.157-.354)	0.685	0.750	0.250	0.063
SNMM644RH(N)	SNMM190616RH(N)	.028 (.018-.039)	.196 (.157-.314)	0.685	0.750	0.250	0.063
SNMM646RH	SNMM190624RH	.037 (.022-.047)	.276 (.157-.394)	0.654	0.750	0.250	0.094
SNMM854RH	SNMM250716RH	.028 (.022-.039)	.354 (.197-.472)	0.937	1.000	0.313	0.063
SNMM856RH	SNMM250724RH	.037 (.022-.047)	.354 (.197-.472)	0.906	1.000	0.313	0.094
SNMM866RH	SNMM250924RH	.033 (.022-.047)	.354 (.197-.472)	0.906	1.000	0.375	0.094

For use in holders MSDNN, MSRNR/L, MSSNR/L, TSDNN, TSKNR/L, TSRNR/L, TSSNR/L, S-MSKNR/L.
See pages 1053 - 1055, 1094 - 1097, 1118.

Part Number	Grade	T5100	T7100	T8020	T8115	T8125	T9225	T9235									
SNMM432RH		●			●	●											
SNMM432RH(N)		●															
SNMM433RH		●				●											
SNMM433RH(N)																	
SNMM434RH																	
SNMM543RH		●			●	●											
SNMM642RH		●															
SNMM643RH		●	●		●	●	●	●									
SNMM643RH(N)																	
SNMM644RH		●	●	●	●	●	●	●									
SNMM644RH(N)		●															
SNMM646RH		●	●			●	●	●									
SNMM854RH						●											
SNMM856RH		●	●		●	●											
SNMM866RH		●				●											

● = P ● = M ● = K ● = N ● = S ○ = H

TOTURN™ TNGG R/L CHIPBREAKER

NEGATIVE TRIANGULAR GROUND INSERTS FOR MEDIUM LIGHT MACHINING

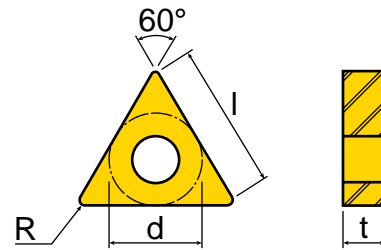

ANSI Number	ISO Number	feed (ipr)	ap (inch)	l	d	t	R
TNGG331L	TNGG160404L	.007 (.005-.012)	.079 (.039-.138)	0.610	0.375	0.187	0.016
TNGG331R	TNGG160404R	.007 (.005-.012)	.079 (.039-.138)	0.610	0.375	0.187	0.016
TNGG332L	TNGG160408L	.010 (.006-.014)	.079 (.051-.138)	0.571	0.375	0.187	0.031
TNGG332R	TNGG160408R	.010 (.006-.014)	.079 (.051-.138)	0.571	0.375	0.187	0.031
TNGG431L	TNGG220404L	.007 (.005-.012)	.118 (.039-.197)	0.827	0.500	0.187	0.016
TNGG431R	TNGG220404R	.007 (.005-.012)	.118 (.039-.197)	0.827	0.500	0.187	0.016
TNGG432L	TNGG220408L	.010 (.006-.014)	.118 (.051-.197)	0.787	0.500	0.187	0.031
TNGG432R	TNGG220408R	.010 (.006-.014)	.118 (.051-.197)	0.787	0.500	0.187	0.031

For use in holders MTCNN, MTENN, MTFNR/L, MTGNR/L, MTJNR/L, TTFNR/L, TTJNR/L, S-MTFNR/L, S-MTUNR/L, A-TTFNR/L, see pages 1056 - 1059, 1098, 1099, 1119, 1120, 1140.

Part Number	Grade	CT3000	K10	P10	P20	TT5100	TT8125												
TNGG331L		●			●		●												
TNGG331R		●	●	●	●		●												
TNGG332L		●			●		●												
TNGG332R		●			●	●	●												
TNGG431L					●		●												
TNGG431R		●			●		●												
TNGG432L		●			●	●	●												
TNGG432R		●			●		●												

● = P ● = M ● = K ● = N ● = S ○ = H

NEGATIVE TRIANGULAR FLAT TOP INSERTS FOR ROUGHING

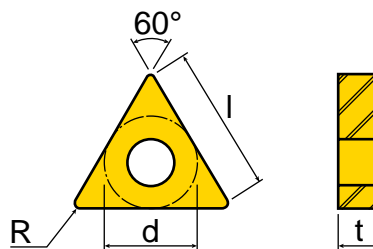

ANSI Number	ISO Number	feed (ipr)	ap (inch)	l	d	t	R	Grade					
								CT3000	K10	T1300	T7310	T8115	
TNMA221	TNMA110304	.012 (.006-.020)	.039 (.020-.079)	0.394	0.250	0.125	0.016						
TNMA331	TNMA160404	.012 (.006-.020)	.118 (.039-.197)	0.610	0.375	0.187	0.016	●	●			●	
TNMA332	TNMA160408	.017 (.006-.026)	.118 (.039-.197)	0.571	0.375	0.187	0.031		●	●	●	●	
TNMA333	TNMA160412	.020 (.006-.026)	.118 (.059-.197)	0.531	0.375	0.187	0.047			●	●	●	
TNMA334	TNMA160416	.020 (.006-.026)	.118 (.059-.197)	0.496	0.375	0.187	0.063					●	
TNMA431	TNMA220404	.012 (.006-.020)	.197 (.039-.276)	0.827	0.500	0.187	0.016						
TNMA432	TNMA220408	.017 (.006-.026)	.197 (.039-.276)	0.787	0.500	0.187	0.031		●	●	●	●	●
TNMA433	TNMA220412	.020 (.006-.026)	.197 (.059-.276)	0.748	0.500	0.187	0.047			●	●	●	

For use in holders MTCNN, MTENN, MTFNR/L, MTGNR/L, MJNR/L, TTFNR/L, TTJNR/L, S-MTFNR/L, S-MTUNR/L, S-PTFNR/L, A-TTFNR/L, see [pages 1056 - 1060, 1099, 1119, 1120, 1124, 1140](#).

● = P ● = M ● = K ● = N ● = S ○ = H

TOTURN™ TNMG COMMON CHIPBREAKER

NEGATIVE TRIANGULAR INSERTS FOR MEDIUM ROUGHING

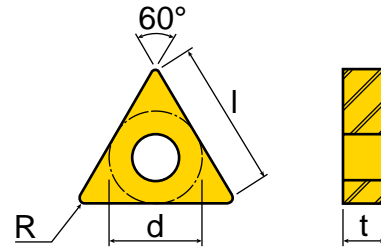

ANSI Number	ISO Number	feed (ipr)	ap (inch)	l	d	t	R
TNMG221	TNMG110304	.009 (.006-.016)	.059 (.047-.118)	0.394	0.250	0.125	0.016
TNMG222	TNMG110308	.011 (.007-.016)	.079 (.059-.118)	0.354	0.250	0.125	0.031
TNMG331	TNMG160404	.011 (.007-.018)	.098 (.059-.138)	0.610	0.375	0.187	0.016
TNMG332	TNMG160408	.015 (.007-.022)	.098 (.079-.138)	0.571	0.375	0.187	0.031
TNMG333	TNMG160412	.018 (.010-.022)	.098 (.079-.138)	0.531	0.375	0.187	0.047
TNMG431	TNMG220404	.011 (.007-.018)	.118 (.059-.197)	0.827	0.500	0.187	0.016
TNMG432	TNMG220408	.015 (.007-.022)	.118 (.079-.197)	0.787	0.500	0.187	0.031
TNMG433	TNMG220412	.018 (.010-.022)	.118 (.079-.197)	0.748	0.500	0.187	0.047
TNMG434	TNMG220416	.020 (.012-.024)	.118 (.079-.197)	0.712	0.500	0.187	0.063
TNMG438	TNMG220432	.020 (.016-.024)	.118 (.059-.197)	0.558	0.500	0.187	0.126
TNMG542	TNMG270608	.015 (.007-.022)	.118 (.079-.197)	1.004	0.625	0.250	0.031
TNMG543	TNMG270612	.018 (.010-.022)	.197 (.118-.276)	0.965	0.625	0.250	0.047
TNMG544	TNMG270616	.020 (.012-.025)	.118 (.079-.197)	0.925	0.625	0.250	0.063
TNMG654	TNMG330716	.021 (.014-.078)	.276 (.118-.354)	1.142	0.750	0.313	0.063
TNMG666	TNMG330924	.024 (.016-.032)	.276 (.118-.354)	1.067	0.750	0.375	0.094

For use in holders MTCNN, MTENN, MTFNR/L, MTGNR/L, MTJNR/L, TTFNR/L, TTJNR/L, S-MTFNR/L, S-MTUNR/L, S-PTFNR/L, A-TTFNR/L, see pages 1056 - 1060, 1099, 1119, 1120, 1124, 1140.

Part Number	Grade	CT3000	K10	P20	P30	TT1300	TT5100	TT7100	TT7220	TT7310	TT8020	TT8115	TT8125						
TNMG221												●	●						
TNMG222							●					●							
TNMG331			●	●			●			●	●	●	●						
TNMG332		●	●	●			●			●	●	●	●						
TNMG333												●							
TNMG431						●	●					●	●						
TNMG432					●	●	●	●	●			●	●						
TNMG433						●						●	●						
TNMG434										●		●	●						
TNMG438						●													
TNMG542													●						
TNMG543									●			●	●						
TNMG544										●			●						
TNMG654								●					●						
TNMG666													●						

● = P ● = M ● = K ● = N ● = S ○ = H

TOTURN™ TNMG FC CHIPBREAKER

NEGATIVE TRIANGULAR INSERTS FOR FINISHING

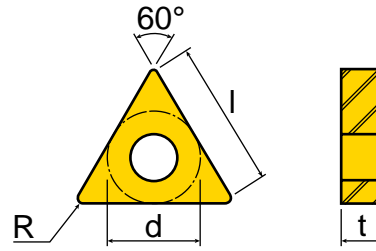

ANSI Number	ISO Number	feed (ipr)	ap (inch)	l	d	t	R
TNMG331FC	TNMG160404FC	.003 (.001-.011)	.019 (.005-.059)	0.610	0.375	0.187	0.016
TNMG332FC	TNMG160408FC	.007 (.002-.013)	.019 (.009-.078)	0.571	0.375	0.187	0.031
TNMG333FC	TNMG160412FC	.008 (.003-.015)	.031 (.031-.118)	0.531	0.375	0.187	0.047

For use in holders MTCNN, MTENN, MTFNR/L, MTGNR/L, MTJNR/L, TTFNR/L, TTJNR/L, S-MTFNR/L, S-MTUNR/L, A-TTFNR/L, see pages 1056 - 1060, 1099, 1119, 1120, 1140.

Part Number	Grade	CT3000	PV3010	TT5100	TT8115	TT8125	TT9215	TT9225	TT9235								
TNMG331FC		●	●	●	●	●		●	●								
TNMG332FC		●	●	●	●	●	●	●	●								
TNMG333FC		●	●	●	●		●	●	●								

● = P ● = M ● = K ● = N ● = S ○ = H

TOTURN™ TNMG FG CHIPBREAKER

NEGATIVE TRIANGULAR INSERTS FOR FINISHING

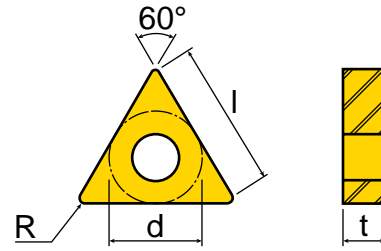

ANSI Number	ISO Number	feed (ipr)	ap (inch)	l	d	t	R
TNMG221FG	TNMG110304FG	.004 (.003-.008)	.031 (.020-.059)	0.394	0.250	0.125	0.016
TNMG322FG	TNMG160308FG	.006 (.004-.010)	.039 (.028-.079)	0.571	0.375	0.125	0.031
TNMG331FG	TNMG160404FG	.004 (.003-.008)	.031 (.020-.079)	0.610	0.375	0.187	0.016
TNMG332FG	TNMG160408FG	.006 (.004-.010)	.039 (.028-.079)	0.571	0.375	0.187	0.031
TNMG333FG	TNMG160412FG	.007 (.005-.012)	.039 (.028-.079)	0.531	0.375	0.187	0.047
TNMG432FG	TNMG220408FG	.006 (.006-.010)	.039 (.028-.079)	0.787	0.500	0.187	0.031

For use in holders MTCNN, MTENN, MTFNR/L, MTGNR/L, MTJNR/L, TTFNR/L, TTJNR/L, S-MTFNR/L, S-MTUNR/L, S-PTFNR/L, A-TTFNR/L, see pages 1056 - 1060, 1099, 1119, 1120, 1124, 1140.

Part Number	Grade	CT3000	PV3010	TT1300	TT5100	TT8115	TT8125												
TNMG221FG		●			●	●													
TNMG322FG							●												
TNMG331FG		●	●	●	●	●	●												
TNMG332FG		●	●		●	●	●												
TNMG333FG						●													
TNMG432FG						●													

● = P ● = M ● = K ● = N ● = S ○ = H

TOTURN™ TNMG R/L-FS CHIPBREAKER

NEGATIVE TRIANGULAR INSERTS FOR SEMI-FINISHING

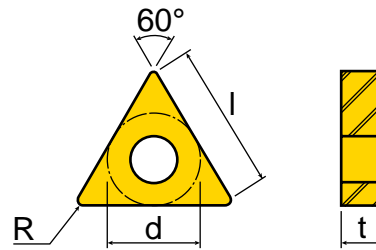

ANSI Number	ISO Number	feed (ipr)	ap (inch)	l	d	t	R	Grade	CT3000	TF5100	T8020	T8125
TNMG331L-FS	TNMG160404L-FS	.008 (.006-.012)	.047 (.031-.118)	0.610	0.375	0.187	0.016		●	●		●
TNMG331R-FS	TNMG160404R-FS	.008 (.006-.012)	.047 (.031-.118)	0.610	0.375	0.187	0.016		●	●	●	●
TNMG332L-FS	TNMG160408L-FS	.012 (.008-.016)	.078 (.040-.137)	0.571	0.375	0.187	0.031			●		●
TNMG332R-FS	TNMG160408R-FS	.012 (.008-.016)	.078 (.040-.137)	0.571	0.375	0.187	0.031			●	●	●
TNMG431R-FS	TNMG220404R-FS	.008 (.006-.012)	.047 (.031-.118)	0.827	0.500	0.187	0.016		●			●

For use in holders MTCNN, MTENN, MTFNR/L, MTGNR/L, MTJNR/L, TTFNR/L, TTJNR/L, S-MTFNR/L, S-MTUNR/L, A-TTFNR/L, see pages 1056 - 1060, 1099, 1119, 1120, 1140. ● = P ● = M ● = K ● = N ● = S ○ = H

TOTURN™ TNMG MC CHIPBREAKER

NEGATIVE TRIANGULAR INSERTS FOR MEDIUM MACHINING/NEGATIVE RAKE ANGLE

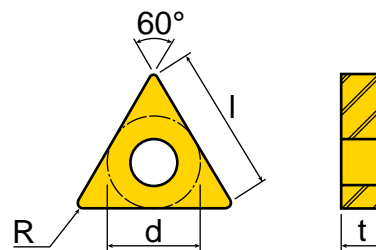

ANSI Number	ISO Number	feed (ipr)	ap (inch)	l	d	t	R	Grade	TF5100	T8020	T8115	T8125
TNMG332MC	TNMG160408MC	.012 (.005-.014)	.059 (.028-.138)	0.571	0.375	0.187	0.031		●	●	●	●

For use in holders MTCNN, MTENN, MTFNR/L, MTGNR/L, MTJNR/L, TTFNR/L, TTJNR/L, S-MTFNR/L, S-MTUNR/L, A-TTFNR/L, see pages 1056 - 1060, 1099, 1119, 1120, 1140. ● = P ● = M ● = K ● = N ● = S ○ = H

TOTURN™ TNMG ML CHIPBREAKER

NEGATIVE TRIANGULAR INSERTS FOR LIGHT MACHINING/VERY POSITIVE RAKE ANGLE

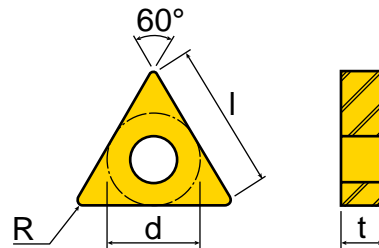

ANSI Number	ISO Number	feed (ipr)	ap (inch)	l	d	t	R
TNMG331ML	TNMG160404ML	.007 (.004-.012)	.059 (.031-.138)	0.610	0.375	0.187	0.016
TNMG332ML	TNMG160408ML	.010 (.005-.014)	.059 (.039-.138)	0.571	0.375	0.187	0.031
TNMG333ML	TNMG160412ML	.012 (.006-.014)	.059 (.059-.138)	0.531	0.375	0.187	0.047
TNMG431ML	TNMG220404ML	.007 (.004-.012)	.098 (.039-.157)	0.827	0.500	0.187	0.016
TNMG432ML	TNMG220408ML	.010 (.005-.014)	.098 (.039-.157)	0.787	0.500	0.187	0.031

For use in holders MTCNN, MTENN, MTFNR/L, MTGNR/L, MTJNR/L, TTFNR/L, TTJNR/L, S-MTFNR/L, S-MTUNR/L, A-TTFNR/L, see pages 1056 - 1060, 1099, 1119, 1120, 1140.

Part Number	Grade													
		K10	TT5030	TT5100	TT8020	TT8115	TT8125							
TNMG331ML		●	●	●	●	●	●							
TNMG332ML		●	●	●	●	●	●							
TNMG333ML				●		●								
TNMG431ML		●		●		●	●							
TNMG432ML		●		●	●	●								

● = P ● = M ● = K ● = N ● = S ○ = H

TOTURN™ TNMG MP CHIPBREAKER

NEGATIVE TRIANGULAR INSERTS FOR MEDIUM MACHINING/POSITIVE RAKE ANGLE

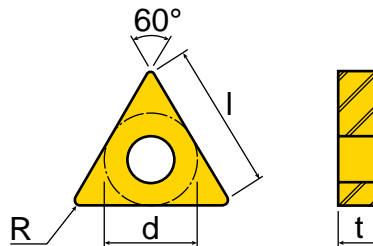

ANSI Number	ISO Number	feed (ipr)	ap (inch)	l	d	t	R
TNMG331MP	TNMG160404MP	.008 (.004-.012)	.059 (.031-.138)	0.610	0.375	0.187	0.016
TNMG332MP	TNMG160408MP	.012 (.005-.016)	.059 (.039-.138)	0.571	0.375	0.187	0.031
TNMG333MP	TNMG160412MP	.014 (.006-.016)	.059 (.059-.138)	0.531	0.375	0.187	0.047
TNMG431MP	TNMG220404MP	.010 (.005-.014)	.079 (.039-.138)	0.827	0.500	0.187	0.016
TNMG432MP	TNMG220408MP	.012 (.005-.016)	.079 (.039-.157)	0.787	0.500	0.187	0.031
TNMG433MP	TNMG220412MP	.014 (.006-.016)	.079 (.039-.157)	0.748	0.500	0.187	0.047

For use in holders MTCNN, MTENN, MTFNR/L, MTGNR/L, MTJNR/L, TTFNR/L, TTJNR/L, S-MTFNR/L, S-MTUNR/L, A-TTFNR/L, see pages 1056 - 1060, 1099, 1119, 1120, 1140.

Part Number	Grade	TT5030	TT5100	TT8020	TT8115	TT8125	TT9030	TT9215	TT9225	TT9235								
TNMG331MP		●	●	●	●	●		●	●	●								
TNMG332MP		●	●	●	●	●	●		●	●								
TNMG333MP		●	●		●				●	●								
TNMG431MP		●				●			●									
TNMG432MP		●	●	●	●	●			●									
TNMG433MP					●													

● = P ● = M ● = K ● = N ● = S ○ = H

TOTURN™ TNMG MT CHIPBREAKER

NEGATIVE TRIANGULAR INSERTS FOR MEDIUM ROUGHING/TOUGH RAKE ANGLE

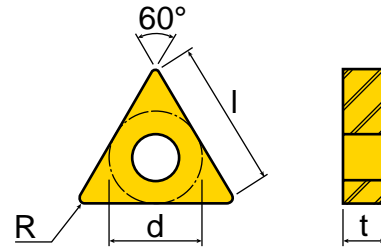

ANSI Number	ISO Number	feed (ipr)	ap (inch)	l	d	t	R
TNMG222MT	TNMG110308MT	.012 (.007-.016)	.059 (.039-.118)	0.354	0.250	0.125	0.031
TNMG331MT	TNMG160404MT	.010 (.006-.016)	.079 (.039-.138)	0.610	0.375	0.187	0.016
TNMG332MT	TNMG160408MT	.014 (.007-.020)	.079 (.047-.138)	0.571	0.375	0.187	0.031
TNMG333MT	TNMG160412MT	.017 (.008-.020)	.079 (.059-.138)	0.531	0.375	0.187	0.047
TNMG431MT	TNMG220404MT	.010 (.006-.016)	.079 (.047-.197)	0.827	0.500	0.187	0.016
TNMG432MT	TNMG220408MT	.014 (.007-.020)	.118 (.047-.197)	0.787	0.500	0.187	0.031
TNMG433MT	TNMG220412MT	.017 (.008-.020)	.118 (.059-.197)	0.748	0.500	0.187	0.047
TNMG543MT	TNMG270612MT	.017 (.008-.020)	.197 (.118-.276)	0.965	0.625	0.250	0.047

For use in holders MTCNN, MTENN, MTFNR/L, MTGNR/L, MTJNR/L, TTFNR/L, TTJNR/L, S-MTFNR/L, S-MTUNR/L, S-PTFNR/L, A-TTFNR/L, see pages 1056 - 1060, 1099, 1119, 1120, 1124, 1140.

Part Number	Grade	CT3000	PV3010	TT1300	TT5030	TT5100	TT7100	TT7310	TT8020	TT8115	TT8125	TT9225	TT9235						
TNMG222MT				●		●				●	●								
TNMG331MT					●	●		●	●	●	●								
TNMG332MT		●	●	●	●	●	●	●	●	●	●	●	●						
TNMG333MT				●		●				●	●	●	●						
TNMG431MT										●	●								
TNMG432MT				●		●	●		●	●	●								
TNMG433MT						●			●	●	●								
TNMG543MT					●	●													

● = P ● = M ● = K ● = N ● = S ○ = H

TOTURN™ TNMG PC CHIPBREAKER

NEGATIVE TRIANGULAR INSERTS FOR MEDIUM MACHINING

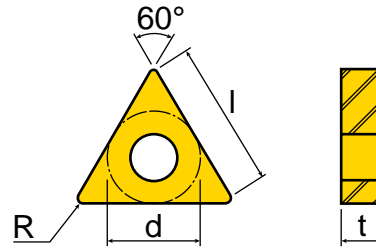

ANSI Number	ISO Number	feed (ipr)	ap (inch)	l	d	t	R
TNMG331PC	TNMG160404PC	.010 (.006-.016)	.079 (.039-.138)	0.610	0.375	0.187	0.016
TNMG332PC	TNMG160408PC	.012 (.006-.020)	.098 (.020-.177)	0.571	0.375	0.187	0.031
TNMG333PC	TNMG160412PC	.014 (.007-.022)	.098 (.024-.177)	0.531	0.375	0.187	0.047
TNMG432PC	TNMG220408PC	.014 (.007-.020)	.118 (.047-.197)	0.787	0.500	0.187	0.031
TNMG433PC	TNMG220412PC	.017 (.008-.020)	.118 (.059-.197)	0.748	0.500	0.187	0.047

For use in holders MTCNN, MTENN, MTFNR/L, MTGNR/L, MTJNR/L, TTFNR/L, TTJNR/L, S-MTFNR/L, S-MTUNR/L, A-TFNR/L, see pages 1056 - 1060, 1099, 1119, 1120, 1140.

Part Number	Grade	TT5100	TT8115	TT8125	TT9215	TT9225	TT9235											
TNMG331PC				●		●												
TNMG332PC		●	●	●	●	●	●											
TNMG333PC		●	●	●		●	●											
TNMG432PC			●	●														
TNMG433PC			●	●														

● = P ● = M ● = K ● = N ● = S ○ = H



TOTURN™ TNMG RT CHIPBREAKER

TRIANGULAR INSERTS FOR ROUGHING WIDE/TOUGH RAKE ANGLE

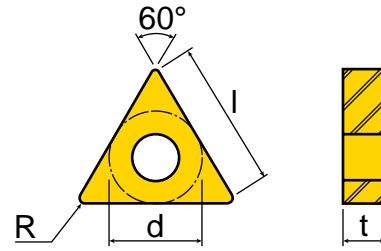

ANSI Number	ISO Number	feed (ipr)	ap (inch)	l	d	t	R
TNMG332RT	TNMG160408RT	.017 (.010-.026)	.118 (.079-.197)	0.571	0.375	0.187	0.031
TNMG333RT	TNMG160412RT	.020 (.010-.026)	.118 (.079-.197)	0.531	0.375	0.187	0.047
TNMG432RT	TNMG220408RT	.017 (.010-.026)	.157 (.079-.276)	0.787	0.500	0.187	0.031
TNMG433RT	TNMG220412RT	.020 (.010-.026)	.157 (.098-.276)	0.748	0.500	0.187	0.047
TNMG666RT	TNMG330924RT	.021 (.014-.028)	.276 (.118-.354)	1.067	0.750	0.375	0.094

For use in holders MTCNN, MTENN, MTFNR/L, MTGNR/L, MTJNR/L, TTFNR/L, TTJNR/L, S-MTFNR/L, S-MTUNR/L, A-TTFNR/L, see pages 1056 - 1060, 1099, 1119, 1120, 1140.

Part Number	Grade																				
	TT1300	TT5100	TT7100	TT7310	TT8115	TT8125															
TNMG332RT																					
TNMG333RT																					
TNMG432RT																					
TNMG433RT																					
TNMG666RT																					

● = P ● = M ● = K ● = N ● = S ○ = H

TOTURN™ TNMG SF CHIPBREAKER

NEGATIVE TRIANGULAR INSERTS FOR SEMI-FINISHING TO FINISHING

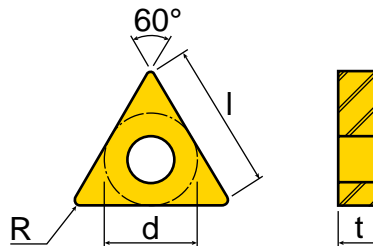

ANSI Number	ISO Number	feed (ipr)	ap (inch)	l	d	t	R	Grade	CT3000	TF5030	TT5100		
-------------	------------	------------	-----------	---	---	---	---	-------	--------	--------	--------	--	--

TNMG332SF	TNMG160408SF	.008 (.004-.012)	.039 (.028-.059)	0.571	0.375	0.187	0.031						
-----------	--------------	------------------	------------------	-------	-------	-------	-------	--	--	--	--	--	--

For use in holders MTCNN, MTENN, MTFNR/L, MTGNR/L, MTJNR/L, TTFNR/L, TTJNR/L, S-MTFNR/L, S-MTUNR/L, A-TTFNR/L, see [pages 1056 - 1060, 1099, 1119, 1120, 1140.](#)

= P = M = K = N = S = H

TOTURN™ TNMG R/L-VF CHIPBREAKER

NEGATIVE TRIANGULAR INSERTS FOR VIBRATION FREE MACHINING WITH VERY LOW CUTTING FORCES

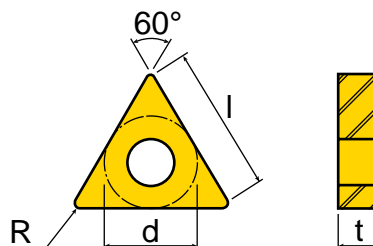

ANSI Number	ISO Number	feed (ipr)	ap (inch)	l	d	t	R	Grade	CT3000	PV3010	TT5100	TT8115	TT8125
-------------	------------	------------	-----------	---	---	---	---	-------	--------	--------	--------	--------	--------

TNMG331L-VF	TNMG160404L-VF	.007 (.004-.012)	.059 (.028-.138)	0.610	0.375	0.187	0.016						
TNMG331R-VF	TNMG160404R-VF	.007 (.004-.012)	.059 (.028-.138)	0.610	0.375	0.187	0.016						
TNMG332L-VF	TNMG160408L-VF	.009 (.005-.014)	.071 (.039-.138)	0.571	0.375	0.187	0.031						
TNMG332R-VF	TNMG160408R-VF	.009 (.005-.014)	.071 (.039-.138)	0.571	0.375	0.187	0.031						

For use in holders MTCNN, MTENN, MTFNR/L, MTGNR/L, MTJNR/L, TTFNR/L, TTJNR/L, S-MTFNR/L, S-MTUNR/L, A-TTFNR/L, see [pages 1056 - 1060, 1099, 1119, 1120, 1140.](#)

= P = M = K = N = S = H

TOTURN™ TNMM RH CHIPBREAKER

NEGATIVE TRIANGULAR INSERTS FOR HIGH FEED ROUGHING

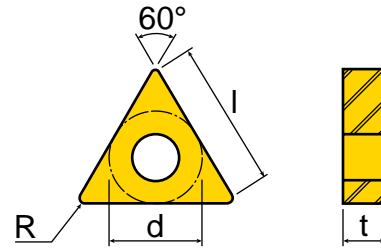
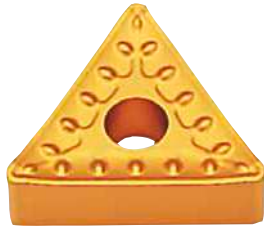

ANSI Number	ISO Number	feed (ipr)	ap (inch)	l	d	t	R	Grade	TF5100	TF8115	TF8125				
TNMM332RH	TNMM160408RH	.019 (.012-.028)	.138 (.079-.276)	0.571	0.375	0.187	0.031								
TNMM333RH	TNMM160412RH	.024 (.012-.028)	.138 (.079-.276)	0.531	0.375	0.187	0.047								
TNMM432RH	TNMM220408RH	.019 (.012-.028)	.157 (.079-.276)	0.787	0.500	0.187	0.031								
TNMM433RH	TNMM220412RH	.024 (.012-.028)	.157 (.098-.276)	0.748	0.500	0.187	0.047								
TNMM434RH	TNMM220416RH	.027 (.016-.033)	.157 (.118-.276)	0.709	0.500	0.187	0.063								
TNMM543RH	TNMM270612RH	.025 (.012-.031)	.197 (.118-.315)	0.965	0.625	0.250	0.047								

For use in holders MTCNN, MTENN, MTFNR/L, MTGNR/L, MTJNR/L, TTFNR/L, TTJNR/L, S-MTFNR/L, S-MTUNR/L, A-TTFNR/L, see pages 1056 - 1060, 1099, 1119, 1120, 1140.

● = P ● = M ● = K ● = N ● = S ○ = H

TOTURN™ VNGG ML CHIPBREAKER

NEGATIVE 35 DEGREE RHOMBIC GROUND INSERTS FOR MEDIUM LIGHT MACHINING/VERY SHARP

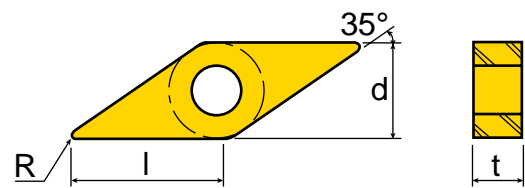

ANSI Number	ISO Number	feed (ipr)	ap (inch)	l	d	t	R	Grade	K10	TF5030				
VNGG330ML	VNGG160401ML	.002 (.001-.003)	.008 (.004-.031)	1.228	0.375	0.187	0.004							
VNGG330.5ML	VNGG160402ML	.003 (.002-.005)	.012 (.008-.040)	1.210	0.375	0.187	0.008							
VNGG331ML	VNGG160404ML	.006 (.004-.010)	.059 (.039-.118)	0.614	0.375	0.187	0.016							
VNGG332ML	VNGG160408ML	.009 (.005-.013)	.059 (.039-.118)	0.575	0.375	0.187	0.032							

For use in holders TVJNR/L, TVQNR/L, TVVNN, S-MVUNR/L, S-MVXNR/L, see pages 1100, 1101, 1121, 1122.

● = P ● = M ● = K ● = N ● = S ○ = H

TOTURN™ VNMG COMMON CHIPBREAKER

NEGATIVE 35 DEGREE RHOMBIC INSERTS FOR MEDIUM ROUGHING

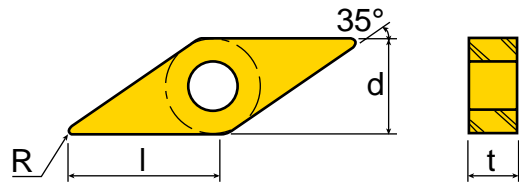
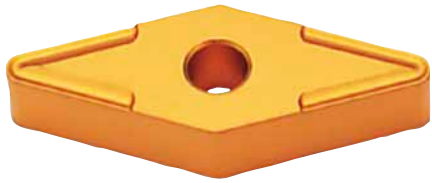

ANSI Number	ISO Number	feed (ipr)	ap (inch)	l	d	t	R
VNMG331	VNMG160404	.010 (.007-.016)	.059 (.039-.118)	0.614	0.375	0.187	0.016
VNMG332	VNMG160408	.013 (.007-.020)	.079 (.059-.118)	0.575	0.375	0.187	0.031
VNMG333	VNMG160412	.016 (.008-.020)	.079 (.059-.118)	0.535	0.375	0.187	0.047
VNMG432	VNMG220408	.013 (.007-.020)	.079 (.059-.118)	0.866	0.500	0.187	0.031

For use in holders TVJNR/L, TVQNR/L, TVVNN, S-MVUNR/L, S-MVXNR/L, see pages 1100, 1101, 1121, 1122.

Part Number	Grade	CT3000	TT1300	TT5100	TT7310	TT8115	TT8125	TT9030									
VNMG331		●	●	●	●	●	●										
VNMG332			●	●	●	●	●										
VNMG333			●		●	●	●	●									
VNMG432						●											

● = P ● = M ● = K ● = N ● = S ○ = H

TOTURN™ VNMG FA CHIPBREAKER

NEGATIVE 35 DEGREE RHOMBIC INSERTS FOR SUPER FINISHING

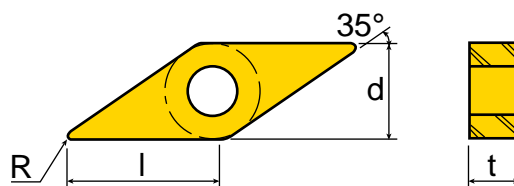

ANSI Number	ISO Number	feed (ipr)	ap (inch)	l	d	t	R
VNMG332FA	VNMG160408FA	.010 (.007-.016)	.059 (.039-.118)	0.575	0.375	0.187	0.016

For use in holders TVJNR/L, TVQNR/L, TVVNN, S-MVUNR/L, S-MVXNR/L, see pages 1100, 1101, 1121, 1122.

Part Number	Grade	CT3000	PV3010	TT5030	TT5100	TT8115	TT8125										
VNMG332FA																	

TOTURN™ VNMG FC CHIPBREAKER

NEGATIVE 35 DEGREE RHOMBIC INSERTS FOR FINISHING

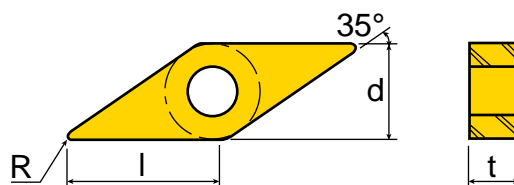

ANSI Number	ISO Number	feed (ipr)	ap (inch)	l	d	t	R
VNMG331FC	VNMG160404FC	.004 (.003-.008)	.020 (.009-.098)	0.614	0.375	0.187	0.016
VNMG332FC	VNMG160408FC	.008 (.003-.014)	.020 (.012-.098)	0.574	0.375	0.187	0.031

For use in holders TVJNR/L, TVQNR/L, TVVNN, S-MVUNR/L, S-MVXNR/L, see pages 1100, 1101, 1121, 1122.

Part Number	Grade	CT3000	PV3010	TT5100	TT8115	TT8125	TT9215	TT9225	TT9235								
VNMG331FC																	
VNMG332FC																	

TOTURN™ VNMG FG CHIPBREAKER

NEGATIVE 35 DEGREE RHOMBIC INSERTS FOR FINISHING

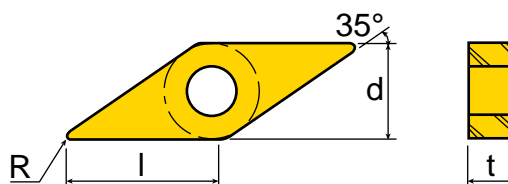

ANSI Number	ISO Number	feed (ipr)	ap (inch)	l	d	t	R
VNMG2.531FG	VNMG130404FG	.004 (.003-.008)	.028 (.020-.059)	0.425	0.313	0.187	0.016
VNMG2.532FG	VNMG130408FG	.005 (.004-.009)	.031 (.020-.079)	0.465	0.313	0.187	0.031
VNMG331FG	VNMG160404FG	.004 (.003-.008)	.031 (.020-.079)	0.614	0.375	0.187	0.016
VNMG332FG	VNMG160408FG	.005 (.004-.009)	.031 (.020-.079)	0.575	0.375	0.187	0.031

For use in holders SVJNR/L, TVJNR/L, TVQNR/L, TVVNN, S-MVUNR/L, S-MVXNR/L, A-SVUNR/L, see pages 1081, 1100, 1101, 1121, 1122, 1133.

Part Number	Grade	CT3000	PV3010	TT5030	TT5100	TT8020	TT8115	TT8125	TT9225									
VNMG2.531FG		●		●	●		●	●										
VNMG2.532FG					●		●	●										
VNMG331FG		●	●	●	●	●	●	●	●									
VNMG332FG		●	●	●	●		●	●										

● = P ● = M ● = K ● = N ● = S ○ = H

TOTURN™ VNMG MT CHIPBREAKER

NEGATIVE 35 DEGREE RHOMBIC INSERTS FOR MEDIUM ROUGHING/TOUGH RAKE ANGLE

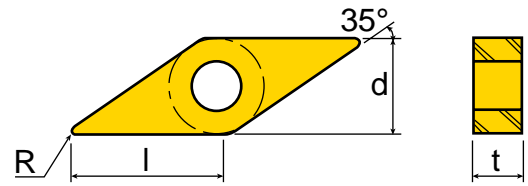

ANSI Number	ISO Number	feed (ipr)	ap (inch)	l	d	t	R
VNMG2.531MT	VNMG130404MT	.009 (.006-.014)	.047 (.031-.098)	0.425	0.313	0.187	0.016
VNMG2.532MT	VNMG130408MT	.011 (.007-.014)	.059 (.039-.118)	0.465	0.313	0.187	0.031
VNMG331MT	VNMG160404MT	.009 (.006-.014)	.047 (.031-.098)	0.614	0.375	0.187	0.016
VNMG332MT	VNMG160408MT	.011 (.007-.014)	.059 (.039-.118)	0.575	0.375	0.187	0.031

For use in holders SVJNR/L, TVJNR/L, TVQNR/L, TVVNN, S-MVUNR/L, S-MVXNR/L, A-SVUNR/L, see pages 1081, 1100, 1101, 1121, 1122, 1133.

Part Number	Grade	CT3000	TT1300	TT5030	TT5100	TT7310	TT8020	TT8115	TT8125	TT9030	TT9215	TT9225	TT9235				
		VNMG2.531MT				●	●	●									
VNMG2.532MT			●	●	●			●	●								
VNMG331MT				●	●			●	●			●					
VNMG332MT		●	●	●	●	●	●	●	●	●	●	●	●				

● = P ● = M ● = K ● = N ● = S ○ = H

TOTURN™ VNMG PC CHIPBREAKER

NEGATIVE 35 DEGREE RHOMBIC INSERTS FOR MEDIUM ROUGHING

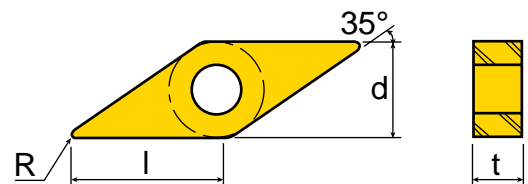

ANSI Number	ISO Number	feed (ipr)	ap (inch)	l	d	t	R	Grade	TT8115	TT8125	TT9225		
VNMG331PC	VNMG160404PC	.009 (.006-.014)	.047 (.031-.118)	0.614	0.375	0.187	0.016		●	●	●		
VNMG332PC	VNMG160408PC	.011 (.007-.014)	.059 (.035-.118)	0.575	0.375	0.187	0.031			●	●		

For use in holders TVJNR/L, TVQNR/L, TVVNN, S-MVUNR/L, S-MVXNR/L, see pages 1100, 1101, 1121, 1122.

● = P ● = M ● = K ● = N ● = S ○ = H

TOTURN™ VNMM ML CHIPBREAKER

NEGATIVE 35 DEGREE RHOMBIC INSERTS FOR MEDIUM LIGHT MACHINING/VERY SHARP

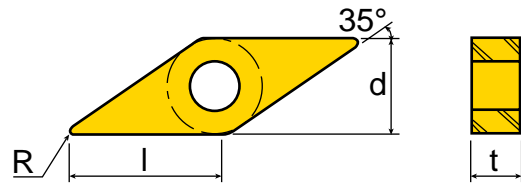

ANSI Number	ISO Number	feed (ipr)	ap (inch)	l	d	t	R	Grade	K10	T15100			
VNMM331ML	VNMM160404ML	.006 (.004-.011)	.047 (.031-.118)	0.614	0.375	0.187	0.016						
VNMM332ML	VNMM160408ML	.009 (.005-.013)	.059 (.039-.118)	0.575	0.375	0.187	0.031						

For use in holders TVJNR/L, TVQNR/L, TVVNN, S-MVUNR/L, S-MVXNR/L, see [pages 1100, 1101, 1121, 1122](#).

● = P ● = M ● = K ● = N ● = S ○ = H

NEGATIVE 80 DEGREE TRIGON FLAT TOP INSERTS FOR ROUGHING

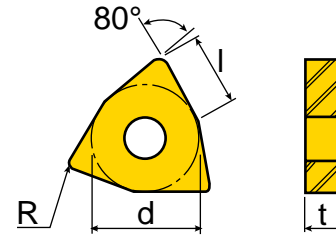

ANSI Number	ISO Number	feed (ipr)	ap (inch)	l	d	t	R
WNMA332	WNMA060408	.018 (.006-.028)	.098 (.039-.157)	0.240	0.375	0.187	0.031
WNMA333	WNMA060412	.020 (.008-.031)	.098 (.059-.157)	0.236	0.375	0.187	0.047
WNMA432	WNMA080408	.017 (.006-.028)	.118 (.039-.197)	0.327	0.500	0.187	0.031
WNMA433	WNMA080412	.020 (.008-.031)	.118 (.059-.197)	0.323	0.500	0.187	0.047
WNMA434	WNMA080416	.020 (.008-.031)	.118 (.059-.197)	0.319	0.500	0.187	0.063

For use in holders MWLNR/L, TWLNR/L, A-TWLNR/L, see pages 1063, 1102, 1141.

Part Number	Grade																			
	TT1300	TT7310																		
WNMA332	●	●																		
WNMA333	●																			
WNMA432	●	●																		
WNMA433	●	●																		
WNMA434		●																		

● = P ● = M ● = K ● = N ● = S ○ = H

TOTURN™ WNMG ET CHIPBREAKER

NEGATIVE 80 DEGREE TRIGON INSERTS FOR MEDIUM TO ROUGH MACHINING

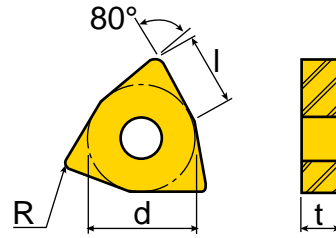

ANSI Number	ISO Number	feed (ipr)	ap (inch)	l	d	t	R
WNMG432ET	WNMG080408ET	.014 (.007-.022)	.118 (.047-.157)	0.327	0.500	0.187	0.031

For use in holders MWLNR/L, TWLNR/L, A-TWLNR/L, see [pages 1063, 1102, 1141](#).

Part Number	Grade	TT5030	TT9215	TT9225	TT9235													
WNMG432ET		●	●	●	●													

● = P ● = M ● = K ● = N ● = S ○ = H

TOTURN™ WNMG FC CHIPBREAKER

NEGATIVE 80 DEGREE TRIGON INSERTS FOR FINISHING

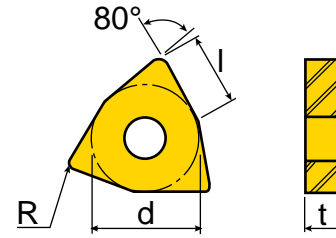

ANSI Number	ISO Number	feed (ipr)	ap (inch)	l	d	t	R
WNMG431FC	WNMG080404FC	.005 (.002-.010)	.019 (.009-.078)	0.331	0.500	0.187	0.016
WNMG432FC	WNMG080408FC	.007 (.002-.013)	.019 (.009-.078)	0.327	0.500	0.187	0.031

For use in holders MWLNR/L, TWLNR/L, A-TWLNR/L, see pages 1063, 1102, 1141.

Part Number	Grade	CT3000	PV3010	TT5100	TT8115	TT8125	TT9215	TT9225	TT9235								
WNMG431FC		●			●	●		●									
WNMG432FC		●	●	●	●	●	●	●	●								

● = P ● = M ● = K ● = N ● = S ○ = H

TOTURN™ WNMG FG CHIPBREAKER

NEGATIVE 80 DEGREE TRIGON INSERTS FOR FINISHING

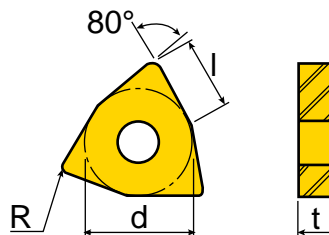

ANSI Number	ISO Number	feed (ipr)	ap (inch)	l	d	t	R
WNMG331FG	WNMG060404FG	.004 (.003-.008)	.031 (.020-.079)	0.244	0.375	0.187	0.016
WNMG332FG	WNMG060408FG	.006 (.004-.010)	.039 (.028-.079)	0.240	0.375	0.187	0.031
WNMG431FG	WNMG080404FG	.004 (.003-.008)	.031 (.020-.079)	0.331	0.500	0.187	0.016
WNMG432FG	WNMG080408FG	.006 (.004-.010)	.039 (.028-.079)	0.327	0.500	0.187	0.031

For use in holders MWLNR/L, TWLNR/L, A-TWLNR/L, see pages 1063, 1102, 1141.

Part Number	Grade	CT3000	K1450	PV3010	TT5030	TT5100	TT8115	TT8125									
WNMG331FG		●		●	●	●	●	●									
WNMG332FG				●		●	●										
WNMG431FG		●		●	●	●	●	●									
WNMG432FG		●	●	●		●	●	●									

● = P ● = M ● = K ● = N ● = S ○ = H

TOTURN™ WNMG MC CHIPBREAKER

NEGATIVE 80 DEGREE TRIGON INSERTS FOR MEDIUM MACHINING/NEGATIVE RAKE ANGLE

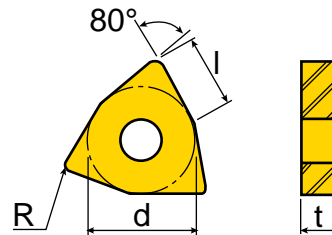

ANSI Number	ISO Number	feed (ipr)	ap (inch)	l	d	t	R
WNMG331MC	WNMG060404MC	.008 (.004-.012)	.047 (.020-.098)	0.244	0.375	0.187	0.016
WNMG332MC	WNMG060408MC	.012 (.005-.014)	.059 (.028-.118)	0.240	0.375	0.187	0.031
WNMG432MC	WNMG080408MC	.012 (.005-.014)	.059 (.028-.138)	0.327	0.500	0.187	0.031
WNMG433MC	WNMG080412MC	.012 (.005-.014)	.059 (.028-.138)	0.323	0.500	0.187	0.047

For use in holders MWLNR/L, TWLNR/L, A-TWLNR/L, see pages 1063, 1102, 1141.

Part Number	Grade														
		CT3000	KT450	TT5100	TT8115	TT8125									
WNMG331MC				●	●										
WNMG332MC				●	●										
WNMG432MC		●	●	●	●	●									
WNMG433MC				●	●										

● = P ● = M ● = K ● = N ● = S ○ = H

TOTURN™ WNMG ML CHIPBREAKER

NEGATIVE 80 DEGREE TRIGON INSERTS FOR MEDIUM LIGHT MACHINING/VERY POSITIVE RAKE ANGLE

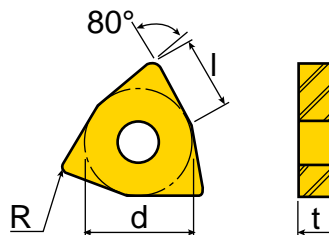
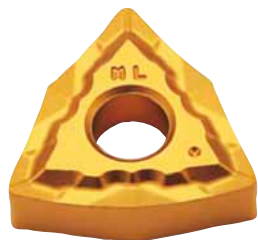

ANSI Number	ISO Number	feed (ipr)	ap (inch)	l	d	t	R
WNMG432ML	WNMG080408ML	.010 (.005-.014)	.059 (.039-.138)	0.327	0.500	0.187	0.031
WNMG433ML	WNMG080412ML	.012 (.006-.014)	.079 (.051-.138)	0.323	0.500	0.187	0.047

For use in holders MWLNR/L, TWLNR/L, A-TWLNR/L, see pages 1063, 1102, 1141.

Part Number	Grade											
	K10	TT5030	TT5100	TT8020	TT8115	TT8125	TT9215	TT9225				
WNMG432ML												
WNMG433ML												

● = P ● = M ● = K ● = N ● = S ○ = H

TOTURN™ WNMG MP CHIPBREAKER

NEGATIVE 80 DEGREE TRIGON INSERTS FOR MEDIUM MACHINING/POSITIVE RAKE ANGLE

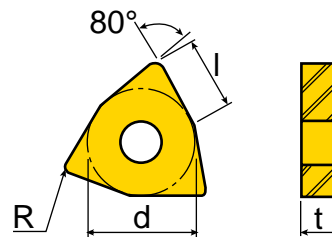

ANSI Number	ISO Number	feed (ipr)	ap (inch)	l	d	t	R
WNMG332MP	WNMG060408MP	.012 (.005-.014)	.059 (.039-.118)	0.240	0.375	0.187	0.031
WNMG333MP	WNMG060412MP	.014 (.006-.016)	.059 (.051-.118)	0.236	0.375	0.187	0.047
WNMG431MP	WNMG080404MP	.010 (.004-.014)	.079 (.039-.157)	0.331	0.500	0.187	0.016
WNMG432MP	WNMG080408MP	.012 (.005-.016)	.079 (.039-.157)	0.327	0.500	0.187	0.031
WNMG433MP	WNMG080412MP	.014 (.006-.016)	.079 (.051-.157)	0.323	0.500	0.187	0.047

For use in holders MWLNR/L, TWLNR/L, A-TWLNR/L, see [pages 1063, 1102, 1141](#).

Part Number	Grade	TT5030	TT5100	TT8020	TT8115	TT8125	TT9030	TT9215	TT9225	TT9235								
		WNMG332MP	●	●	●	●	●	●		●								
WNMG333MP		●		●														
WNMG431MP					●													
WNMG432MP	●	●	●	●	●	●	●	●	●	●								
WNMG433MP		●		●	●			●	●	●								

● = P ● = M ● = K ● = N ● = S ○ = H

TOTURN™ WNMG MT CHIPBREAKER

NEGATIVE 80 DEGREE TRIGON INSERTS FOR MEDIUM ROUGHING/TOUGH RAKE ANGLE

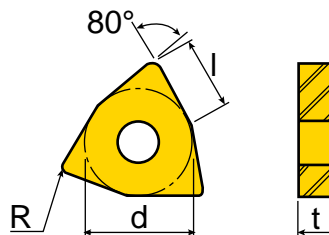

ANSI Number	ISO Number	feed (ipr)	ap (inch)	l	d	t	R
WNMG331MT	WNMG060404MT	.010 (.006-.016)	.079 (.039-.118)	0.244	0.375	0.187	0.016
WNMG332MT	WNMG060408MT	.014 (.006-.018)	.079 (.047-.118)	0.240	0.375	0.187	0.031
WNMG333MT	WNMG060412MT	.017 (.008-.020)	.079 (.059-.118)	0.236	0.375	0.187	0.047
WNMG431MT	WNMG080404MT	.010 (.005-.016)	.118 (.039-.157)	0.331	0.500	0.187	0.016
WNMG432MT	WNMG080408MT	.014 (.007-.022)	.118 (.047-.157)	0.327	0.500	0.187	0.031
WNMG433MT	WNMG080412MT	.017 (.010-.022)	.118 (.059-.157)	0.323	0.500	0.187	0.047

For use in holders MWLNR/L, TWLNR/L, A-TWLNR/L, see pages 1063, 1102, 1141.

Part Number	Grade	CT3000	TT1300	TT5030	TT5100	TT7100	TT7310	TT8020	TT8115	TT8125	TT9030	TT9215	TT9225	TT9235				
		WNMG331MT		●	●	●				●	●	●			●			
WNMG332MT			●	●	●			●	●	●			●					
WNMG333MT					●				●	●								
WNMG431MT		●	●	●	●		●		●	●			●					
WNMG432MT		●	●	●	●	●	●	●	●	●	●	●	●	●	●			
WNMG433MT			●	●	●		●	●	●	●	●	●	●	●				

● = P ● = M ● = K ● = N ● = S ○ = H

TOTURN™ WNMG PC CHIPBREAKER

NEGATIVE 80 DEGREE TRIGON INSERTS FOR MEDIUM MACHINING

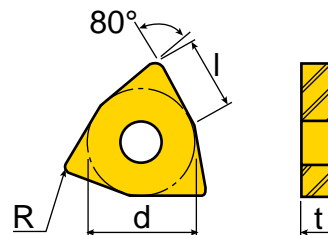
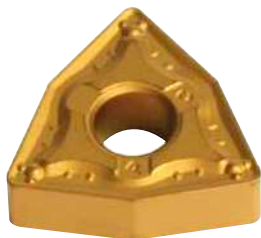

ANSI Number	ISO Number	feed (ipr)	ap (inch)	l	d	t	R
WNMG332PC	WNMG060408PC	.012 (.006-.020)	.098 (.020-.157)	0.240	0.375	0.187	0.031
WNMG333PC	WNMG060412PC	.014 (.007-.020)	.098 (.024-.157)	0.236	0.375	0.187	0.047
WNMG432PC	WNMG080408PC	.012 (.006-.020)	.098 (.020-.157)	0.327	0.500	0.187	0.031
WNMG433PC	WNMG080412PC	.014 (.007-.022)	.098 (.031-.157)	0.323	0.500	0.187	0.047
WNMG434PC	WNMG080416PC	.016 (.008-.024)	.098 (.031-0157)	0.319	0.500	0.187	0.063

For use in holders MWLNR/L, TWLNR/L, A-TWLNR/L, see [pages 1063, 1102, 1141](#).

Part Number	Grade	TT5100	TT8115	TT8125	TT9215	TT9225	TT9235											
WNMG332PC			●	●														
WNMG333PC				●														
WNMG432PC		●	●	●	●	●	●											
WNMG433PC		●	●	●	●	●	●											
WNMG434PC				●														

● = P ● = M ● = K ● = N ● = S ○ = H

TOTURN™ WNMG RT CHIPBREAKER

NEGATIVE 80 DEGREE TRIGON INSERTS FOR ROUGHING/WIDE, TOUGH RAKE ANGLE

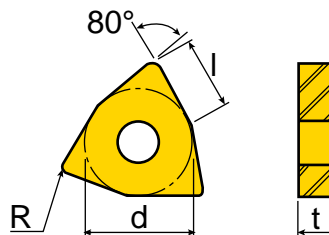

ANSI Number	ISO Number	feed (ipr)	ap (inch)	l	d	t	R
WNMG432RT	WNMG080408RT	.018 (.010-.028)	.157 (.098-.157)	0.327	0.500	0.187	0.031
WNMG433RT	WNMG080412RT	.022 (.010-.028)	.157 (.098-.157)	0.323	0.500	0.187	0.047
WNMG434RT	WNMG080416RT	.024 (.012-.030)	.157 (.098-.157)	0.319	0.500	0.187	0.063

For use in holders MWLNR/L, TWLNR/L, A-TWLNR/L, see [pages 1063, 1102, 1141](#).

Part Number	Grade	TT1300	TT5030	TT5100	TT7100	TT7310	TT8115	TT8125	TT9215	TT9225	TT9235						
WNMG432RT		●	●	●	●	●	●	●	●	●	●						
WNMG433RT		●	●	●	●	●	●	●									
WNMG434RT		●				●	●										

● = P ● = M ● = K ● = N ● = S ○ = H

TOTURN™ WNMG WS CHIPBREAKER

NEGATIVE 80 DEGREE TRIGON WIPER INSERTS FOR SUPER FINISHING

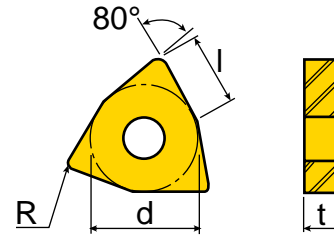

ANSI Number	ISO Number	feed (ipr)	ap (inch)	l	d	t	R	Grade	TT1300	TT5100	TT7310	TT8115	TT8125
-------------	------------	------------	-----------	---	---	---	---	-------	--------	--------	--------	--------	--------

WNMG432WS	WNMG080408WT	.018 (.006-.024)	.079 (.039-.157)	0.327	0.500	0.187	0.031		●	●	●	●	●
-----------	--------------	------------------	------------------	-------	-------	-------	-------	--	---	---	---	---	---

For use in holders MWLNR/L, TWLNR/L, A-TWLNR/L, see pages 1063, 1102, 1141.

● = P ● = M ● = K ● = N ● = S ○ = H

TOTURN™ WNMG WT CHIPBREAKER

NEGATIVE 80 DEGREE TRIGON WIPER INSERTS FOR MEDIUM ROUGHING

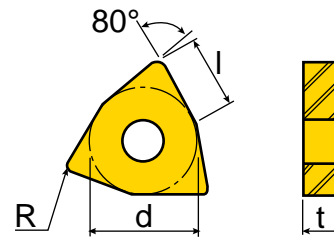

ANSI Number	ISO Number	feed (ipr)	ap (inch)	l	d	t	R
-------------	------------	------------	-----------	---	---	---	---

WNMG332WT	WNMG060408WT	.018 (.006-.024)	.059 (.028-.138)	0.240	0.375	0.187	0.031
WNMG432WT	WNMG080408WT	.018 (.006-.024)	.079 (.039-.157)	0.327	0.500	0.187	0.031
WNMG433WT	WNMG080412WT	.020 (.008-.031)	.079 (.039-.157)	0.323	0.500	0.187	0.047

For use in holders MWLNR/L, TWLNR/L, A-TWLNR/L, see pages 1063, 1102, 1141.

Part Number	Grade	CT3000	TT1300	TT5100	TT7310	TT8115	TT8125												
-------------	-------	--------	--------	--------	--------	--------	--------	--	--	--	--	--	--	--	--	--	--	--	--

WNMG332WT			●	●		●	●												
WNMG432WT			●	●	●	●	●												
WNMG433WT		●		●	●	●	●												

● = P ● = M ● = K ● = N ● = S ○ = H

TOTURN™ CCET R/L GF CHIPBREAKER

POSITIVE 7° CLEARANCE 80 DEGREE RHOMBIC GROUND INSERTS FOR SMALL PARTS

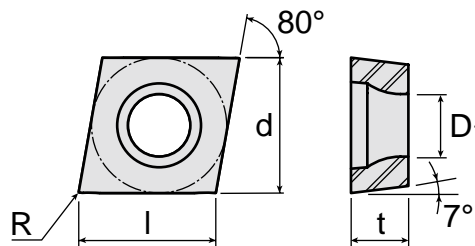

ANSI Number	ISO Number	feed (ipr)	ap (inch)	l	d	t	R	D1	Grade	TT9020
CCET21.50L-GF	CCET060201L-GF	.002 (.001-.006)	.024 (.008-.060)	0.248	0.250	0.094	0.004	0.110	●●●	
CCET21.50R-GF	CCET060201R-GF	.002 (.001-.006)	.024 (.008-.060)	0.248	0.250	0.094	0.004	0.110	●●●	
CCET21.50.5L-GF	CCET060202L-GF	.003 (.001-.007)	.031 (.012-.060)	0.244	0.250	0.094	0.008	0.110	●●●	
CCET21.50.5R-GF	CCET060202R-GF	.003 (.001-.007)	.031 (.012-.060)	0.244	0.250	0.094	0.008	0.110	●●●	
CCET21.51L-GF	CCET060204L-GF	.004 (.002-.008)	.031 (.012-.060)	0.236	0.250	0.094	0.016	0.110	●●●	
CCET21.51R-GF	CCET060204R-GF	.004 (.002-.008)	.031 (.012-.060)	0.236	0.250	0.094	0.016	0.110	●●●	
CCET21.52L-GF	CCET060208L-GF	.005 (.003-.009)	.031 (.016-.060)	0.220	0.250	0.094	0.031	0.110	●●●	
CCET32.50L-GF	CCET09T301L-GF	.002 (.001-.006)	.024 (.008-.100)	0.374	0.375	0.156	0.004	0.173	●●●	
CCET32.50R-GF	CCET09T301R-GF	.002 (.001-.006)	.024 (.008-.100)	0.374	0.375	0.156	0.004	0.173	●●●	
CCET32.50.5L-GF	CCET09T302L-GF	.003 (.001-.007)	.031 (.012-.100)	0.370	0.375	0.156	0.008	0.173	●●●	
CCET32.50.5R-GF	CCET09T302R-GF	.003 (.001-.007)	.031 (.012-.100)	0.370	0.375	0.156	0.008	0.173	●●●	
CCET32.51L-GF	CCET09T304L-GF	.004 (.002-.008)	.031 (.012-.100)	0.362	0.375	0.156	0.016	0.173	●●●	
CCET32.51R-GF	CCET09T304R-GF	.004 (.002-.008)	.031 (.012-.100)	0.362	0.375	0.156	0.016	0.173	●●●	
CCET32.52L-GF	CCET09T308L-GF	.005 (.003-.009)	.031 (.016-.100)	0.346	0.375	0.156	0.031	0.173	●●●	

For use in holders SCACR-SH, SCLCR/L, SCLCR-SH, E-SCLCR/L (CARBIDE), S-SCLCR/L, see page 1064 - 1066, 1125, 1126.

● = P ● = M ● = K ● = N ● = S ○ = H

TOTURN™ CCET R/L GW CHIPBREAKER

POSITIVE 7° CLEARANCE 80 DEGREE RHOMBIC GROUND INSERTS WITH WIPER GEOMETRY FOR SMALL PARTS

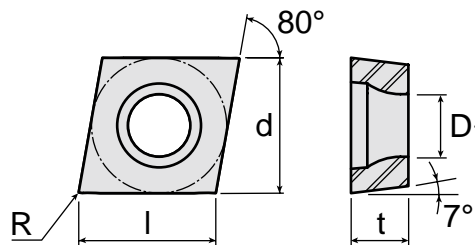

ANSI Number	ISO Number	feed (ipr)	ap (inch)	l	d	t	R	D1	Grade	TT9020
CCET21.5X0L-GW	CCET0602003L-GW	.003 (.001-.006)	.012 (.004-.060)	0.252	0.250	0.094	0.001	0.110	●●●	
CCET21.5X0R-GW	CCET0602003R-GW	.003 (.001-.006)	.012 (.004-.060)	0.252	0.250	0.094	0.001	0.110	●●●	
CCET32.5X0L-GW	CCET09T3003L-GW	.003 (.001-.006)	.012 (.004-.060)	0.378	0.375	0.156	0.001	0.173	●●●	
CCET32.5X0R-GW	CCET09T3003R-GW	.003 (.001-.006)	.012 (.004-.060)	0.378	0.375	0.156	0.001	0.173	●●●	

For use in holders SCACR-SH, SCLCR/L, SCLCR-SH, E-SCLCR/L (CARBIDE), S-SCLCR/L, see page 1064 - 1066, 1125, 1126.

● = P ● = M ● = K ● = N ● = S ○ = H

TOTURN™ CCMT FA CHIPBREAKER

POSITIVE 7° CLEARANCE 80 DEGREE RHOMBIC INSERTS FOR SUPER FINISHING

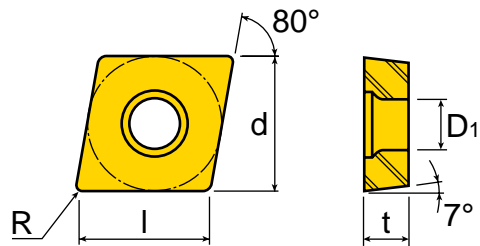

ANSI Number	ISO Number	feed (ipr)	ap (inch)	l	d	t	R	D1
CCMT21.50.5FA	CCMT060202FA	.003 (.002-.006)	.012 (.004-.059)	0.244	0.250	0.094	0.008	0.110
CCMT21.51FA	CCMT060204FA	.003 (.002-.006)	.016 (.004-.059)	0.236	0.250	0.094	0.016	0.110
CCMT32.50.5FA	CCMT09T302FA	.003 (.002-.006)	.012 (.004-.079)	0.370	0.375	0.156	0.008	0.173
CCMT32.51FA	CCMT09T304FA	.004 (.002-.008)	.016 (.004-.079)	0.362	0.375	0.156	0.016	0.173
CCMT32.52FA	CCMT09T308FA	.006 (.004-.010)	.020 (.008-.079)	0.346	0.375	0.156	0.031	0.173

For use in holders SCACR-SH, SCLCR/L, SCLCR-SH, E-SCLCR/L (CARBIDE), S-SCLCR/L, see page 1064 - 1066, 1125, 1126.

Part Number	Grade	CT3000	PV3010	TT5030	TT5100	TT8020	TT8125											
CCMT21.50.5FA		●		●	●													
CCMT21.51FA		●	●	●	●	●	●											
CCMT32.50.5FA		●	●	●	●													
CCMT32.51FA		●	●	●	●	●	●											
CCMT32.52FA			●	●	●		●											

● = P ● = M ● = K ● = N ● = S ○ = H

TOTURN™ CCMT FG CHIPBREAKER

POSITIVE 7° CLEARANCE 80 DEGREE RHOMBIC INSERTS FOR FINISHING

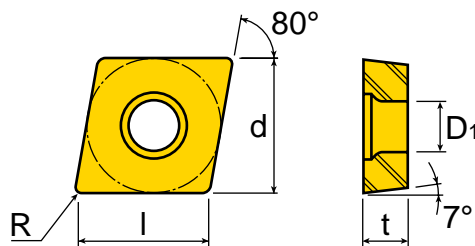
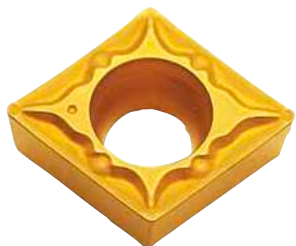

ANSI Number	ISO Number	feed (ipr)	ap (inch)	l	d	t	R	D1
CCMT21.51FG	CCMT060204FG	.003 (.002-.006)	.020 (.012-.060)	0.236	0.250	0.094	0.016	0.110
CCMT32.51FG	CCMT09T304FG	.003 (.002-.006)	.020 (.012-.059)	0.362	0.375	0.156	0.016	0.173
CCMT32.52FG	CCMT09T308FG	.006 (.004-.010)	.039 (.024-.079)	0.346	0.375	0.156	0.031	0.173
CCMT432FG	CCMT120408FG	.006 (.004-.010)	.039 (.024-.079)	0.472	0.500	0.187	0.031	0.217

For use in holders SCACR-SH, SCLCR/L, SCLCR-SH, E-SCLCR/L (CARBIDE), S-SCLCR/L, see page 1064 - 1066, 1125, 1126.

Part Number	Grade	CT3000	PV3010	TT1300	TT5030	TT5100	TT8020	TT8125	TT9225	TT9235								
CCMT21.51FG		●	●		●	●	●	●	●	●								
CCMT32.51FG		●	●	●	●	●	●	●	●	●								
CCMT32.52FG		●	●	●	●	●		●	●	●								
CCMT432FG			●			●		●										

● = P ● = M ● = K ● = N ● = S ○ = H

TOTURN™ CCMT MT CHIPBREAKER

POSITIVE 7° CLEARANCE 80 DEGREE RHOMBIC INSERTS FOR MEDIUM MACHINING

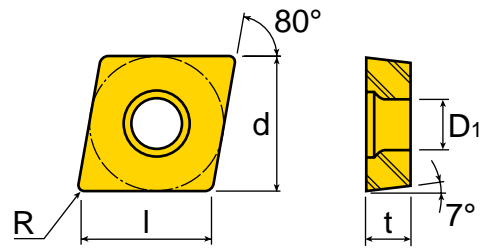

ANSI Number	ISO Number	feed (ipr)	ap (inch)	l	d	t	R	D1
CCMT21.51MT	CCMT060204MT	.004 (.003-.008)	.028 (.020-.079)	0.236	0.250	0.094	0.016	0.110
CCMT21.52MT	CCMT060208MT	.007 (.005-.012)	.039 (.028-.079)	0.220	0.250	0.094	0.031	0.110
CCMT32.51MT	CCMT09T304MT	.006 (.004-.010)	.059 (.028-.138)	0.362	0.375	0.156	0.016	0.173
CCMT32.52MT	CCMT09T308MT	.007 (.005-.012)	.059 (.039-.138)	0.346	0.375	0.156	0.031	0.173
CCMT431MT	CCMT120404MT	.007 (.005-.012)	.079 (.051-.197)	0.488	0.500	0.187	0.016	0.217
CCMT432MT	CCMT120408MT	.007 (.005-.012)	.079 (.051-.197)	0.472	0.500	0.187	0.031	0.217
CCMT433MT	CCMT120412MT	.009 (.007-.014)	.079 (.059-.197)	0.457	0.500	0.187	0.047	0.217
CCMT53.52MT	CCMT160508MT	.009 (.007-.014)	.100 (.059-.236)	0.602	0.500	0.219	0.031	0.217

For use in holders SCACR-SH, SCLCR/L, SCLCR-SH, E-SCLCR/L (CARBIDE), S-SCLCR/L, see page 1064 - 1066, 1125, 1126.

Part Number	Grade	CT3000	K10	P30	PV3010	TT1300	TT5030	TT5100	TT7310	TT8020	TT8115	TT8125	TT9225	TT9235				
CCMT21.51MT		●	●	●	●	●	●	●	●	●	●	●	●	●				
CCMT21.52MT		●				●		●	●	●	●	●						
CCMT32.51MT		●			●	●	●	●	●	●	●	●	●	●				
CCMT32.52MT						●	●	●	●	●	●	●	●	●				
CCMT431MT		●				●		●	●	●	●	●						
CCMT432MT		●				●	●	●	●	●	●	●	●	●				
CCMT433MT						●					●	●						
CCMT53.52MT								●										

● = P ● = M ● = K ● = N ● = S ○ = H

TOTURN™ CCMT WT CHIPBREAKER

POSITIVE 7° CLEARANCE 80 DEGREE RHOMBIC WIPER INSERTS FOR FINISHING OR HIGHER FEED RATES

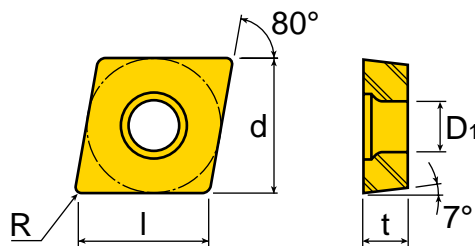

ANSI Number	ISO Number	feed (ipr)	ap (inch)	l	d	t	R	D1
CCMT32.52WT	CCMT09T308WT	.011 (.003-.015)	.059 (.027-.118)	0.346	0.375	0.156	0.031	0.173

For use in holders SCACR-SH, SCLCR/L, SCLCR-SH, E-SCLCR/L (CARBIDE), S-SCLCR/L, see page 1064 - 1066, 1125, 1126.

Part Number	Grade	TT1300	TT5100	TT8115	TT8125												
CCMT32.52WT																	

● = P ● = M ● = K ● = N ● = S ○ = H

TOTURN™ CPGT C CHIPBREAKER

POSITIVE 11° CLEARANCE 80 DEGREE RHOMBIC GROUND INSERTS FOR FINISHING

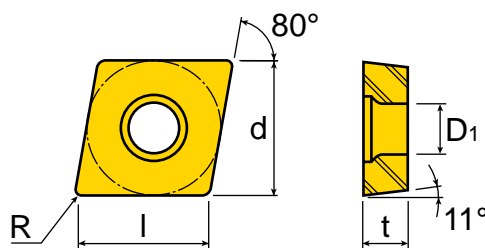

ANSI Number	ISO Number	feed (ipr)	ap (inch)	l	d	t	R	D1	Grade	CT3000
CPGT2.51.51C	CPGT080204C	.003 (.002-.008)	.028 (.016-.059)	0.299	0.313	0.094	0.016	0.134		
CPGT321C	CPGT090304C	.003 (.002-.008)	.028 (.016-.079)	0.362	0.375	0.125	0.016	0.173		

● = P ● = M ● = K ● = N ● = S ○ = H

TOTURN™ CPMT FG CHIPBREAKER

POSITIVE 11° CLEARANCE 80 DEGREE RHOMBIC INSERTS FOR FINISHING

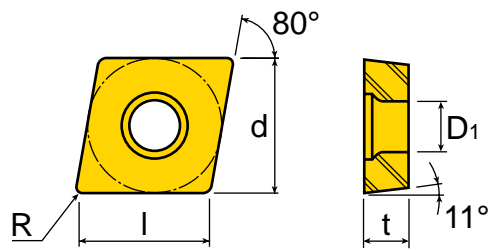
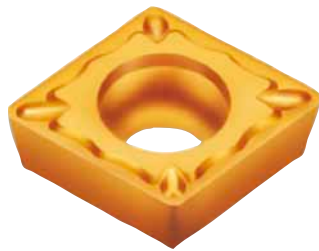

ANSI Number	ISO Number	feed (ipr)	ap (inch)	l	d	t	R	D1
CPMT2.51.51FG	CPMT080204FG	.004 (.003-.008)	.027 (.015-.059)	0.299	0.313	0.094	0.016	0.134
CPMT2.51.52FG	CPMT080208FG	.006 (.004-.010)	.039 (.023-.059)	0.283	0.313	0.094	0.031	0.134
CPMT321FG	CPMT090304FG	.004 (.003-.008)	.027 (.015-.079)	0.362	0.375	0.125	0.016	0.173
CPMT322FG	CPMT090308FG	.006 (.004-.010)	.039 (.023-.078)	0.346	0.375	0.125	0.031	0.173

Part Number	Grade									
	CT3000	TT5100	TT8125							
CPMT2.51.51FG	●	●	●							
CPMT2.51.52FG	●	●	●							
CPMT321FG	●	●	●							
CPMT322FG	●	●	●							

● = P ● = M ● = K ● = N ● = S ○ = H

TOTURN™ CPMT PC CHIPBREAKER

POSITIVE 11° CLEARANCE 80 DEGREE RHOMBIC INSERTS FOR MEDIUM MACHINING

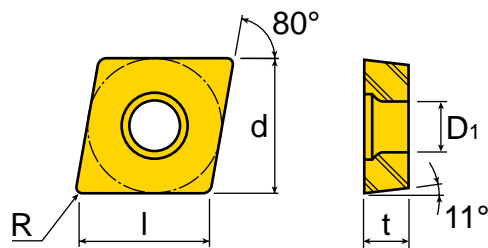

ANSI Number	ISO Number	feed (ipr)	ap (inch)	l	d	t	R	D1	Grade	
									TT5030	TT5100
CPMT21.51PC	CPMT060204PC	.004 (.002-.007)	.025 (.008-.094)	0.236	0.250	0.094	0.016	0.110	●	●
CPMT21.52PC	CPMT060208PC	.006 (.003-.009)	.025 (.016-.094)	0.220	0.250	0.094	0.016	0.110	●	●
CPMT32.51PC	CCMT09T304PC	.003 (.002-.006)	.012 (.004-.079)	0.362	0.375	0.156	0.016	0.173	●	●
CPMT32.52PC	CPMT09T308PC	.006 (.004-.010)	.020 (.008-.079)	0.346	0.375	0.156	0.031	0.173	●	●

For use in holders S-SCFPR/L & S-SCLPR/L, see page 1127.

● = P ● = M ● = K ● = N ● = S ○ = H

TOTURN™ DCET R/L GF CHIPBREAKER

POSITIVE 7° CLEARANCE 55 DEGREE RHOMBIC GROUND INSERTS FOR SMALL PARTS

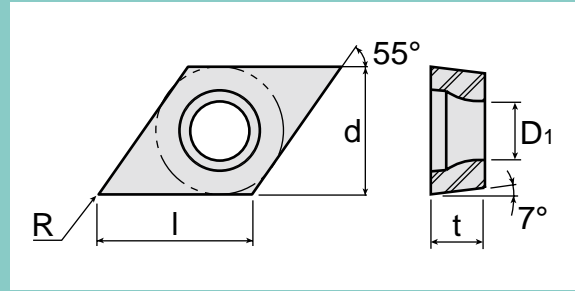

ANSI Number	ISO Number	feed (ipr)	ap (inch)	l	d	t	R	D1	Grade	TT9020
DCET21.50L-GF	DCET070201L-GF	.002 (.001-.006)	.024 (.008-.060)	0.299	0.250	0.094	0.004	0.110		
DCET21.50R-GF	DCET070201R-GF	.002 (.001-.006)	.024 (.008-.060)	0.299	0.250	0.094	0.004	0.110		
DCET21.50.5L-GF	DCET070202L-GF	.003 (.001-.007)	.031 (.012-.060)	0.295	0.250	0.094	0.008	0.110		
DCET21.50.5R-GF	DCET070202R-GF	.003 (.001-.007)	.031 (.012-.060)	0.295	0.250	0.094	0.008	0.110		
DCET21.51L-GF	DCET070204L-GF	.004 (.002-.008)	.031 (.012-.060)	0.287	0.250	0.094	0.016	0.110		
DCET21.51R-GF	DCET070204R-GF	.004 (.002-.008)	.031 (.012-.060)	0.287	0.250	0.094	0.016	0.110		
DCET32.50L-GF	DCET11T301L-GF	.002 (.001-.006)	.024 (.008-.100)	0.449	0.375	0.094	0.004	0.173		
DCET32.50R-GF	DCET11T301R-GF	.002 (.001-.006)	.024 (.008-.100)	0.449	0.375	0.156	0.004	0.173		
DCET32.50.5L-GF	DCET11T302L-GF	.003 (.001-.007)	.031 (.012-.100)	0.445	0.375	0.156	0.008	0.173		
DCET32.50.5R-GF	DCET11T302R-GF	.003 (.001-.007)	.031 (.012-.100)	0.445	0.375	0.156	0.008	0.173		
DCET32.51L-GF	DCET11T304L-GF	.003 (.002-.008)	.031 (.012-.100)	0.441	0.375	0.156	0.016	0.173		
DCET32.51R-GF	DCET11T304R-GF	.003 (.002-.008)	.031 (.012-.100)	0.441	0.375	0.156	0.016	0.173		

For use in holders SDJCR/L, SDJCR/L-SH, SDNCN-SH, SDPCN, E-SDUCR (CARBIDE), S-SDUCR/L, see pages 1067, 1068, 1070, 1071, 1128.

● = P ● = M ● = K ● = N ● = S ○ = H

TOTURN™ DCET R/L GW CHIPBREAKER

POSITIVE 7° CLEARANCE 55 DEGREE RHOMBIC GROUND INSERTS WITH WIPER GEOMETRY FOR SMALL PARTS

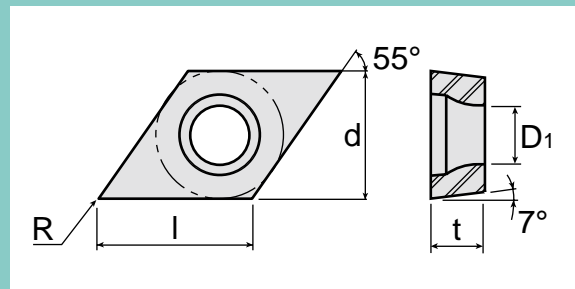

ANSI Number	ISO Number	feed (ipr)	ap (inch)	l	d	t	R	D1	Grade	TT9020
DCET21.5X0L-GW	DCET0702003L-GW	.003 (.001-.006)	.012 (.004-.060)	0.295	0.250	0.094	0.001	0.110		
DCET21.5X0R-GW	DCET0702003R-GW	.003 (.001-.006)	.012 (.004-.060)	0.295	0.250	0.094	0.001	0.110		
DCET32.5X0L-GW	DCET11T3003L-GW	.003 (.001-.006)	.012 (.004-.100)	0.449	0.375	0.156	0.001	0.173		
DCET32.5X0R-GW	DCET11T3003R-GW	.003 (.001-.006)	.012 (.004-.100)	0.449	0.375	0.156	0.001	0.173		

For use in holders SDJCR/L, SDJCR/L-SH, SDNCN-SH, SDPCN, E-SDUCR (CARBIDE), S-SDUCR/L, see pages 1067, 1068, 1070, 1071, 1128.

● = P ● = M ● = K ● = N ● = S ○ = H

TOTURN™ DCMT FA CHIPBREAKER

POSITIVE 7° CLEARANCE 55 DEGREE RHOMBIC INSERTS FOR SUPER FINISHING

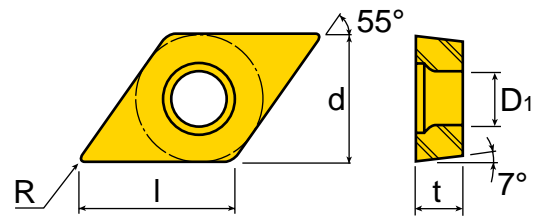

ANSI Number	ISO Number	feed (ipr)	ap (inch)	l	d	t	R	D1
DCMT21.50.5FA	DCMT070202FA	.003 (.002-.006)	.012 (.006-.060)	0.295	0.250	0.094	0.008	0.110
DCMT32.50.5FA	DCMT11T302FA	.003 (.002-.006)	.012 (.006-.060)	0.445	0.375	0.156	0.008	0.173

For use in holders SDJCR/L, SDJCR/L-SH, SDNCN-SH, SDPCN, E-SDUCR (CARBIDE), S-SDUCR/L, see [pages 1067, 1068, 1070, 1071, 1128](#).

Part Number	Grade	CT3000	PV3010	TT5030	TT5100	TT9215												
DCMT21.50.5FA		●		●	●													
DCMT32.50.5FA		●	●	●	●	●												

● = P ● = M ● = K ● = N ● = S ○ = H

TOTURN™ DCMT FG CHIPBREAKER

POSITIVE 7° CLEARANCE 55 DEGREE RHOMBIC INSERTS FOR FINISHING

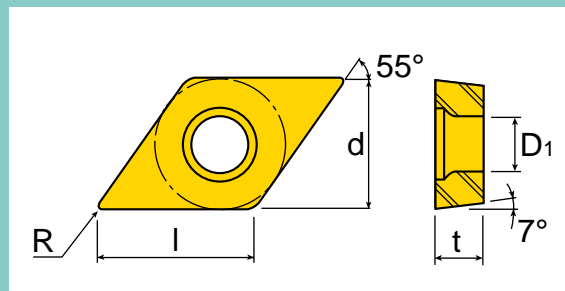

ANSI Number	ISO Number	feed (ipr)	ap (inch)	l	d	t	R	D1
DCMT21.51FG	DCMT070204FG	.004 (.003-.008)	.028 (.016-.059)	0.287	0.250	0.094	0.016	0.110
DCMT21.52FG	DCMT070208FG	.006 (.004-.009)	.028 (.016-.059)	0.276	0.250	0.094	0.031	0.110
DCMT32.51FG	DCMT11T304FG	.004 (.003-.008)	.028 (.024-.079)	0.441	0.375	0.156	0.016	0.173
DCMT32.52FG	DCMT11T308FG	.006 (.004-.010)	.039 (.024-.079)	0.425	0.375	0.156	0.031	0.173

For use in holders SDJCR/L, SDJCR/L-SH, SDNCN-SH, SDPCN, E-SDUCR (CARBIDE), S-SDUCR/L, see pages 1067, 1068, 1070, 1071, 1128.

Part Number	Grade	CT3000	PV3010	TT5030	TT5100	TT8020	TT8115	TT8125	TT9215	TT9225	TT9235							
		DCMT21.51FG		●	●	●	●	●	●		●	●						
DCMT21.52FG			●		●	●		●		●								
DCMT32.51FG		●	●	●	●	●	●		●	●	●							
DCMT32.52FG		●	●	●	●		●	●		●	●							

● = P ● = M ● = K ● = N ● = S ○ = H

TOTURN™ DCMT MT CHIPBREAKER

POSITIVE 7° CLEARANCE 55 DEGREE RHOMBIC INSERTS FOR MEDIUM MACHINING

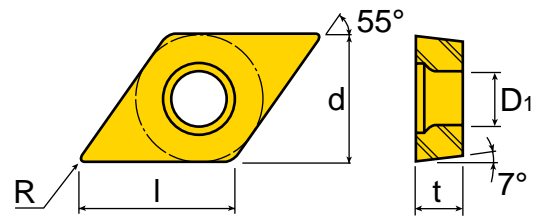

ANSI Number	ISO Number	feed (ipr)	ap (inch)	l	d	t	R	D1
DCMT32.51MT	DCMT11T304MT	.006 (.004-.010)	.039 (.028-.118)	0.441	0.375	0.156	0.016	0.173
DCMT32.52MT	DCMT11T308MT	.007 (.005-.012)	.059 (.039-.138)	0.425	0.375	0.156	0.031	0.173
DCMT32.53MT	DCMT11T312MT	.009 (.007-.014)	.079 (.059-.118)	0.413	0.375	0.156	0.047	0.173

For use in holders SDJCR/L, SDJCR/L-SH, SDNCN-SH, SDPCN, E-SDUCR (CARBIDE), S-SDUCR/L, see pages 1067, 1068, 1070, 1071, 1128.

Part Number	Grade	CT3000	PV3010	TT1300	TT5030	TT5100	TT7310	TT8020	TT8115	TT8125	TT9225	TT9235						
DCMT32.51MT		●	●		●	●	●	●	●	●	●	●						
DCMT32.52MT		●		●	●	●	●	●	●	●	●	●						
DCMT32.53MT		●		●		●	●		●									

● = P ● = M ● = K ● = N ● = S ○ = H

TOTURN™ RCMT MT CHIPBREAKER

POSITIVE 7° CLEARANCE ROUND INSERTS FOR MEDIUM MACHINING

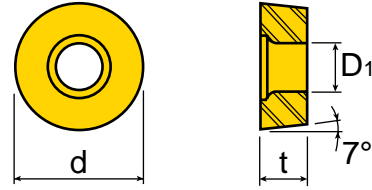

ANSI Number	ISO Number	feed (ipr)	ap (inch)	d	t	D1
RCMT10T300MT	RCMT10T300MT	.012 (.008-.020)	.079 (.039-.157)	0.394	0.156	0.173
RCMT120400MT	RCMT120400MT	.016 (.012-.024)	.118 (.079-.197)	0.472	0.187	0.173
RCMT160600MT	RCMT160600MT	.024 (.016-.032)	.157 (.118-.276)	0.630	0.250	0.217

For use in holders SRDCN & SRGCR/L, see [pages 1072 & 1073](#).

Part Number	Grade	TT1300	TT8115	TT8125													
RCMT10T300MT		●		●													
RCMT120400MT		●	●	●													
RCMT160600MT		●		●													

● = P ● = M ● = K ● = N ● = S ○ = H

TOTURN™ RCMX CHIPBREAKER

POSITIVE 7° CLEARANCE ROUND INSERTS FOR ROUGHING

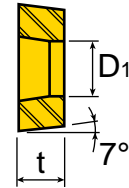
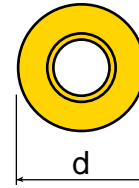

ANSI Number	ISO Number	feed (ipr)	ap (inch)	d	t	D1
RCMX100300	RCMX100300	.014 (.010-.020)	.098 (.059-.157)	0.394	0.125	0.142
RCMX120400	RCMX120400	.018 (.012-.024)	.138 (.098-.197)	0.472	0.187	0.165
RCMX160600	RCMX160600	.022 (.016-.030)	.197 (.118-.276)	0.630	0.250	0.205
RCMX200600	RCMX200600	.028 (.019-.035)	.236 (.138-.354)	0.787	0.250	0.256
RCMX250700	RCMX250700	.033 (.022-.047)	.315 (.197-.472)	0.984	0.313	0.283
RCMX320900	RCMX320900	.039 (.026-.059)	.394 (.197-.591)	1.260	0.375	0.374

Part Number	Grade	K20	TT1300	TT5100	TT7100	TT7310	TT8020	TT8115	TT8125										
RCMX100300			●	●				●	●										
RCMX120400		●	●	●		●		●	●										
RCMX160600			●	●		●		●	●										
RCMX200600			●	●		●		●	●										
RCMX250700			●		●	●	●	●	●										
RCMX320900			●		●			●	●										

● = P ● = M ● = K ● = N ● = S ○ = H

TOTURN™ SCMT FG CHIPBREAKER

POSITIVE 7° CLEARANCE SQUARE INSERTS FOR FINISHING

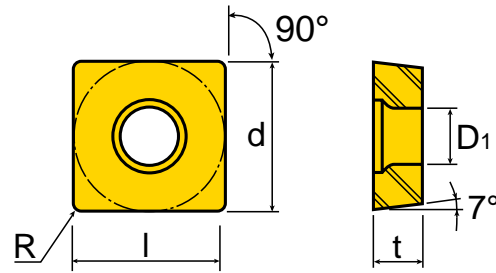
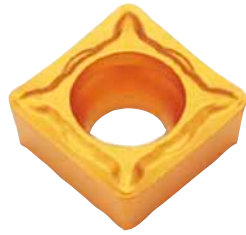

ANSI Number	ISO Number	feed (ipr)	ap (inch)	l	d	t	R	D1
SCMT32.52FG	SCMT09T308FG	.006 (.004-.010)	.039 (.024-.079)	0.343	0.375	0.156	0.031	0.173

For use in holder SSDCN, see [pages 1074](#).

Part Number	Grade	TT5030	TT5100	TT8020	TT8115	TT8125	TT9225										
SCMT32.52FG		●	●	●	●	●	●										

● = P ● = M ● = K ● = N ● = S ○ = H

TOTURN™ SCMT MT CHIPBREAKER

POSITIVE 7° CLEARANCE SQUARE INSERTS FOR MEDIUM MACHINING

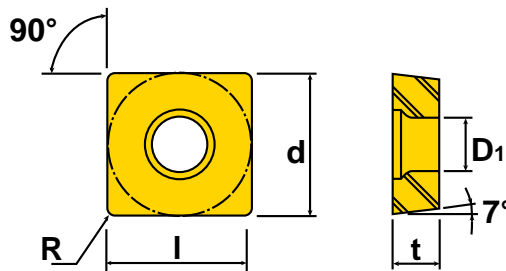

ANSI Number	ISO Number	feed (ipr)	ap (inch)	l	d	t	R	D1
SCMT32.51MT	SCMT09T304MT	.006 (.004-.010)	.059 (.028-.138)	0.358	0.375	0.156	0.016	0.173
SCMT32.52MT	SCMT09T308MT	.007 (.005-.012)	.059 (.039-.138)	0.343	0.375	0.156	0.031	0.173
SCMT431MT	SCMT120404MT	.006 (.004-.010)	.079 (.039-.197)	0.484	0.500	0.187	0.016	0.217
SCMT432MT	SCMT120408MT	.007 (.005-.012)	.079 (.039-.197)	0.469	0.500	0.187	0.031	0.217
SCMT433MT	SCMT120412MT	.009 (.006-.014)	.079 (.039-.197)	0.453	0.500	0.187	0.047	0.217

For use in holder SSDCN, see pages 1074.

Part Number	Grade	CT3000	KT450	TT1300	TT3500	TT5030	TT5100	TT7100	TT7310	TT8020	TT8115	TT8125	TT9225	TT9235				
SCMT32.51MT		●	●	●			●		●	●	●	●	●					
SCMT32.52MT		●	●	●		●	●	●	●	●	●	●	●					
SCMT431MT		●		●			●				●	●						
SCMT432MT		●	●	●		●	●		●	●	●	●	●	●				
SCMT433MT				●	●				●		●							

● = P ● = M ● = K ● = N ● = S ○ = H

POSITIVE 11° CLEARANCE FLAT TOP SQUARE GROUND INSERTS FOR FINISHING

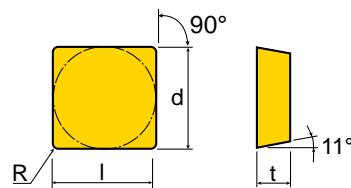

ANSI Number	ISO Number	feed (ipr)	ap (inch)	l	d	t	R
SPG321	SPGN090304	.005 (.003-.008)	.059 (.028-.138)	0.358	0.375	0.125	0.016
SPG322	SPGN090308	.006 (.004-.010)	.059 (.028-.138)	0.343	0.375	0.125	0.031
SPG421	SPGN120304	.005 (.003-.008)	.079 (.039-.197)	0.484	0.500	0.125	0.016
SPG422	SPGN120308	.006 (.004-.010)	.079 (.039-.197)	0.469	0.500	0.125	0.031
SPG423	SPGN120312	.008 (.006-.012)	.079 (.039-.197)	0.453	0.500	0.125	0.047
SPG431	SPGN120404	.005 (.003-.008)	.079 (.039-.197)	0.484	0.500	0.187	0.016
SPG432	SPGN120408	.006 (.004-.010)	.079 (.039-.197)	0.469	0.500	0.187	0.031
SPG433	SPGN120412	.008 (.006-.012)	.079 (.039-.197)	0.453	0.500	0.187	0.047
SPG434	SPGN120416	.009 (.007-.013)	.079 (.039-.197)	0.437	0.500	0.187	0.063
SPG531	SPGN150404	.005 (.003-.008)	.118 (.059-.275)	0.606	0.625	0.187	0.016
SPG532	SPGN150408	.006 (.004-.010)	.118 (.059-.275)	0.591	0.625	0.187	0.031
SPG533	SPGN150412	.008 (.006-.012)	.118 (.059-.275)	0.575	0.625	0.187	0.047
SPG631	SPGN190404	.005 (.003-.008)	.157 (.059-.354)	0.732	0.750	0.187	0.016
SPG632	SPGN190408	.006 (.004-.010)	.157 (.059-.354)	0.717	0.750	0.187	0.031

For use in holder CSDPN, see [pages 1044](#).

Part Number	Grade	AS10	K10	K20	P20	P30	TT1300	TT6030	TT8115	TT8125								
SPG321			●	●					●									
SPG322			●	●			●	●	●									
SPG421			●		●		●											
SPG422		●	●	●	●	●			●	●								
SPG423			●			●												
SPG431				●														
SPG432			●	●					●									
SPG433		●		●				●										
SPG434			●															
SPG531			●			●			●									
SPG532					●													
SPG533				●														
SPG631					●				●									
SPG632			●		●													

● = P ● = M ● = K ● = N ● = S ○ = H

TOTURN™ SPMR CHIPBREAKER

POSITIVE 11° CLEARANCE SQUARE INSERTS FOR MEDIUM MACHINING

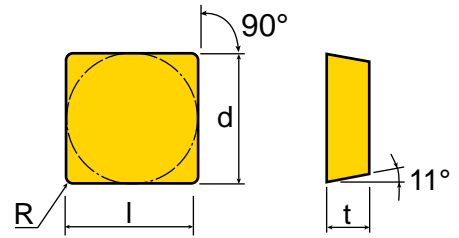

ANSI Number	ISO Number	feed (ipr)	ap (inch)	l	d	t	R	D1
SPMR321	SPMR090304	.006 (.004-.010)	.059 (.028-.138)	0.358	0.375	0.125	0.016	-
SPMR322	SPMR090308	.007 (.005-.012)	.059 (.039-.138)	0.343	0.375	0.125	0.031	-
SPMR421	SPMR120304	.006 (.004-.010)	.079 (.039-.197)	0.484	0.500	0.125	0.016	-
SPMR422	SPMR120308	.007 (.005-.012)	.079 (.039-.197)	0.469	0.500	0.125	0.031	-
SPMR423	SPMR120312	.008 (.006-.014)	.079 (.039-.197)	0.453	0.500	0.125	0.047	-

For use in holder CSDPN, see [pages 1044](#).

Part Number	Grade										
	CT3000	KT450	P20	TT3500	TT5100	TT8115	TT8125				
SPMR321						●	●				
SPMR322	●	●			●	●	●				
SPMR421				●	●	●	●				
SPMR422			●		●	●	●				
SPMR423											

● = P ● = M ● = K ● = N ● = S ○ = H

POSITIVE 11° CLEARANCE FLAT TOP SQUARE INSERTS FOR MEDIUM MACHINING

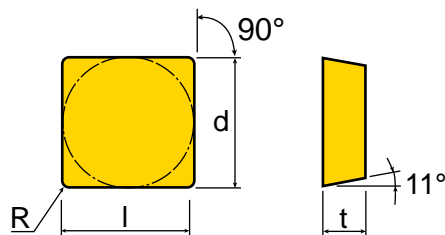

ANSI Number	ISO Number	feed (ipr)	ap (inch)	l	d	t	R
SPU321	SPUN090304	.008 (.004-.012)	.059 (.039-.138)	0.358	0.375	0.125	0.016
SPU322	SPUN090308	.012 (.006-.016)	.059 (.039-.138)	0.343	0.375	0.125	0.031
SPU421	SPUN120304	.008 (.004-.012)	.098 (.039-.197)	0.484	0.375	0.125	0.016
SPU422	SPUN120308	.012 (.006-.016)	.098 (.039-.197)	0.469	0.500	0.125	0.031
SPU423	SPUN120312	.016 (.008-.020)	.098 (.039-.197)	0.453	0.500	0.125	0.047
SPU531	SPUN150404	.008 (.004-.012)	.118 (.059-.275)	0.606	0.625	0.187	0.016
SPU633	SPUN190412	.016 (.008-.020)	.157 (.059-.354)	0.701	0.750	0.187	0.047

For use in holder CSDPN, see [page 1044](#).

Part Number	Grade	CT3000	K10	K20	P20	P30	T13500	T16030	T18115	T18125								
SPU321		●			●				●	●								
SPU322						●												
SPU421			●		●	●			●									
SPU422		●	●	●	●	●	●	●	●	●								
SPU423			●			●												
SPU531																		
SPU633						●				●								

● = P ● = M ● = K ● = N ● = S ○ = H

TOTURN™ TCET R/L GF CHIPBREAKER

POSITIVE 7° CLEARANCE TRIANGULAR GROUND INSERTS FOR SMALL PARTS

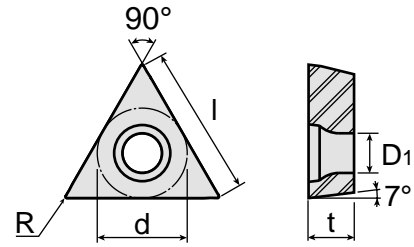

ANSI Number	ISO Number	feed (ipr)	ap (inch)	l	d	t	R	D1	Grade	TT9020
TCET220L-GF	TCET110301L-GF	.002 (.001-.006)	.024 (.008-.060)	0.421	0.250	0.125	0.004	0.110		
TCET220R-GF	TCET110301R-GF	.002 (.001-.006)	.024 (.008-.060)	0.421	0.250	0.125	0.004	0.110		
TCET220.5L-GF	TCET110302L-GF	.003 (.001-.007)	.031 (.012-.060)	0.413	0.250	0.125	0.008	0.110		
TCET220.5R-GF	TCET110302R-GF	.003 (.001-.007)	.031 (.012-.060)	0.413	0.250	0.125	0.008	0.110		
TCET221R-GF	TCET110304R-GF	.004 (.002-.008)	.039 (.020-.079)	0.394	0.250	0.125	0.016	0.110		

For use in holder STGCR-SH, see page 1077.

● = P ● = M ● = K ● = N ● = S ○ = H

TOTURN™ TCMT FG CHIPBREAKER

POSITIVE 7° CLEARANCE TRIANGULAR INSERTS FOR FINISHING

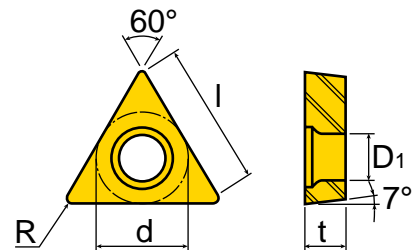

ANSI Number	ISO Number	feed (ipr)	ap (inch)	l	d	t	R	D1
TCMT732FG	TCMT090208FG	.006 (.004-.010)	.039 (.024-.059)	0.299	0.219	0.094	0.031	0.098
TCMT21.51FG	TCMT110204FG	.004 (.003-.008)	.039 (.016-.059)	0.394	0.250	0.094	0.016	0.110
TCMT21.52FG	TCMT110208FG	.006 (.004-.010)	.039 (.024-.059)	0.354	0.250	0.094	0.031	0.110
TCMT32.51FG	TCMT16T304FG	.004 (.003-.008)	.039 (.016-.079)	0.610	0.375	0.156	0.016	0.173
TCMT32.52FG	TCMT16T308FG	.006 (.004-.010)	.039 (.024-.079)	0.571	0.375	0.156	0.031	0.173

For use in holders STFCR/L, STGCR/L, E-STFCR/L (CARBIDE), S-STFCR/L, S-STUCR/L, see pages 1075, 1076, 1130 - 1132.

Part Number	Grade	CT3000	PV3010	TT3500	TT5030	TT5100	TT8020	TT8115	TT8125	TT9225	TT9235							
TCMT732FG		●	●			●		●	●									
TCMT21.51FG		●	●		●	●	●		●	●	●							
TCMT21.52FG			●		●	●		●	●	●	●							
TCMT32.51FG		●	●			●		●	●									
TCMT32.52FG		●	●	●	●	●		●	●	●	●							

● = P ● = M ● = K ● = N ● = S ○ = H

POSITIVE 7° CLEARANCE TRIANGULAR INSERTS FOR MEDIUM MACHINING

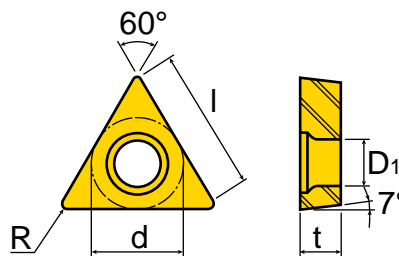
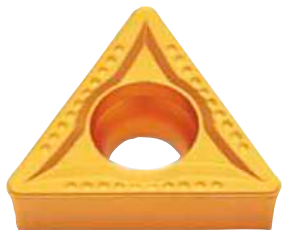

ANSI Number	ISO Number	feed (ipr)	ap (inch)	l	d	t	R	D1
TCMT731MT	TCMT090204MT	.006 (.004-.010)	.039 (.024-.079)	0.339	0.219	0.094	0.016	0.098
TCMT732MT	TCMT090208MT	.007 (.005-.012)	.039 (.031-.079)	0.299	0.219	0.094	0.031	0.098
TCMT21.51MT	TCMT110204MT	.006 (.004-.010)	.059 (.024-.118)	0.394	0.250	0.094	0.016	0.110
TCMT21.52MT	TCMT110208MT	.007 (.005-.012)	.059 (.031-.138)	0.354	0.250	0.094	0.031	0.110
TCMT32.51MT	TCMT16T304MT	.006 (.004-.010)	.079 (.031-.197)	0.610	0.375	0.156	0.016	0.173
TCMT32.52MT	TCMT16T308MT	.007 (.004-.012)	.079 (.039-.197)	0.571	0.375	0.156	0.031	0.173
TCMT32.53MT	TCMT16T312MT	.008 (.004-.012)	.079 (.059-.197)	0.531	0.375	0.156	0.047	0.173

For use in holders STFCR/L, STGCR/L, E-STFCR/L (CARBIDE), S-STFCR/L, S-STUCR/L, see pages 1075, 1076, 1130 - 1132.

Part Number	Grade	CT3000	K10	KT450	PV3010	TT1300	TT3500	TT5030	TT5100	TT7310	TT8020	TT8115	TT8125	TT9225	TT9235
TCMT731MT		●			●	●		●	●	●		●	●	●	●
TCMT732MT				●		●			●	●		●	●		
TCMT21.51MT		●	●			●		●	●	●		●	●	●	●
TCMT21.52MT		●		●		●		●	●	●		●	●	●	●
TCMT32.51MT		●		●		●		●	●	●		●	●	●	●
TCMT32.52MT		●		●		●		●	●	●		●	●	●	●
TCMT32.53MT						●						●			

● = P ● = M ● = K ● = N ● = S ○ = H

POSITIVE 11° CLEARANCE FLAT TOP, GROUND TRIANGULAR INSERTS FOR FINISHING

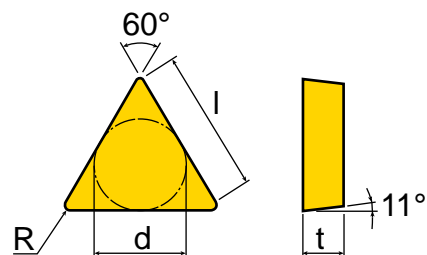
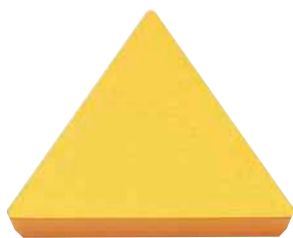

ANSI Number	ISO Number	feed (ipr)	ap (inch)	l	d	t	R
TPG221	TPGN110304	.005 (.003-.008)	.059 (.028-.118)	0.394	0.250	0.125	0.016
TPG222	TPGN110308	.006 (.004-.010)	.059 (.039-.118)	0.354	0.250	0.125	0.031
TPG320.5	TPGN160302	.004 (.002-.007)	.079 (.039-.197)	0.630	0.375	0.125	0.008
TPG321	TPGN160304	.005 (.003-.008)	.079 (.039-.197)	0.610	0.375	0.125	0.016
TPG322	TPGN160308	.006 (.004-.010)	.079 (.039-.197)	0.571	0.375	0.125	0.031
TPG323	TPGN160312	.008 (.006-.012)	.079 (.039-.197)	0.531	0.375	0.125	0.047
TPG431	TPGN220404	.004 (.003-.008)	.118 (.059-.276)	0.827	0.500	0.187	0.016
TPG432	TPGN220408	.006 (.004-.010)	.118 (.059-.276)	0.787	0.500	0.187	0.031
TPG433	TPGN220412	.008 (.006-.012)	.118 (.059-.276)	0.748	0.500	0.187	0.047
TPG434	TPGN220416	.010 (.008-.014)	.118 (.059-.276)	0.709	0.500	0.187	0.063
TPG436	TPGN220425	.012 (.010-.016)	.118 (.059-.276)	0.622	0.500	0.187	0.098
TPG438	TPG220430	.014 (.012-.018)	.118 (.059-.276)	0.575	0.500	0.187	0.118
TPG542	TPGN270608	.006 (.006-.010)	.197 (.118-.315)	1.004	0.625	0.250	0.031

For use in holder CTAPR/L, CTCON, CTFPR/L, CTGPR/L, S-CTFPR/L, see [pages 1045 - 1048, 1115](#).

Part Number	Grade	CT3000	K10	K20	P20	P30	TT1300	TT6030	TT8115	TT8125								
TPG221		●	●	●	●	●		●	●	●								
TPG222			●	●		●	●		●									
TPG320.5																		
TPG321		●	●	●					●	●								
TPG322		●	●	●	●	●			●	●								
TPG323		●	●			●												
TPG431			●	●	●	●												
TPG432			●	●	●				●	●								
TPG433					●													
TPG434					●													
TPG436																		
TPG438						●												
TPG542									●									

● = P ● = M ● = K ● = N ● = S ○ = H

TOTURN™ TPGT R/L-C CHIPBREAKER

POSITIVE 11° CLEARANCE TRIANGULAR GROUND INSERTS FOR FINISHING

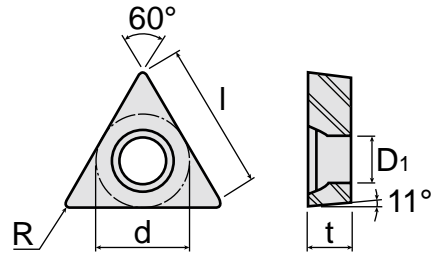
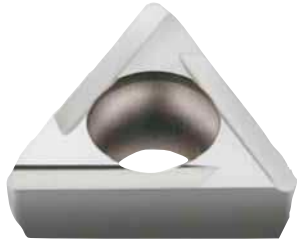

ANSI Number	ISO Number	feed (ipr)	ap (inch)	l	d	t	R	D1	Grade	CT3000
TPGT221L-C	TPGT110304L-C	.003 (.002-.008)	.031 (.019-.078)	0.394	0.250	0.125	0.016	0.134	●●●●●	
TPGT221R-C	TPGT110304R-C	.003 (.002-.008)	.031 (.019-.078)	0.394	0.250	0.125	0.016	0.134	●●●●●	
TPGT222L-C	TPGT110308L-C	.004 (.003-.010)	.031 (.019-.078)	0.354	0.250	0.125	0.031	0.134	●●●●●	
TPGT331L-C	TPGT160404L-C	.003 (.002-.008)	.059 (.027-.118)	0.610	0.375	0.187	0.016	0.173	●●●●●	
TPGT331R-C	TPGT160404R-C	.003 (.002-.008)	.059 (.027-.118)	0.610	0.375	0.187	0.016	0.173	●●●●●	
TPGT731L-C	TPGT090204L-C	.003 (.002-.008)	.024 (.012-.059)	0.339	0.219	0.094	0.016	0.098	●●●●●	

● = P ● = M ● = K ● = N ● = S ○ = H

TOTURN™ TPGX R/L CHIPBREAKER

POSITIVE 11° CLEARANCE TRIANGULAR GROUND INSERTS FOR FINISHING

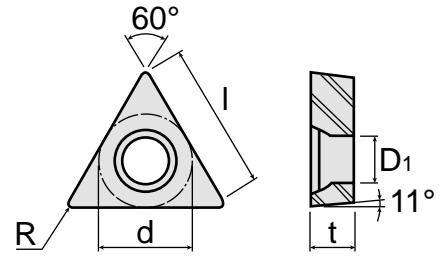
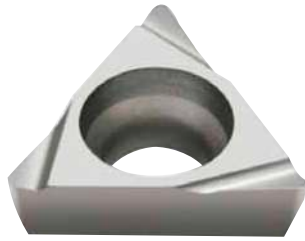

ANSI Number	ISO Number	feed (ipr)	ap (inch)	l	d	t	R	D1
TPGX730.5L	TPGX090202L	.003 (.002-.006)	.028 (.012-.039)	0.358	0.219	0.094	0.008	0.118
TPGX731L	TPGX090204L	.005 (.003-.008)	.039 (.024-.059)	0.339	0.219	0.094	0.016	0.118
TPGX220.5L	TPGX110302L	.003 (.002-.006)	.028 (.012-.039)	0.413	0.250	0.125	0.008	0.138
TPGX220.5R	TPGX110302R	.003 (.002-.006)	.028 (.012-.039)	0.413	0.250	0.125	0.008	0.138
TPGX221L	TPGX110304L	.005 (.003-.008)	.039 (.024-.079)	0.394	0.250	0.125	0.016	0.138
TPGX221R	TPGX110304R	.005 (.003-.008)	.039 (.024-.079)	0.394	0.250	0.125	0.016	0.138

Part Number	Grade									
	CT3000	K10	K20	PV3010						
TPGX730.5L	●			●						
TPGX731L	●	●	●							
TPGX220.5L	●			●						
TPGX220.5R	●									
TPGX221L	●	●								
TPGX221R	●									

● = P ● = M ● = K ● = N ● = S ○ = H

TOTURN™ TPMR COMMON CHIPBREAKER

POSITIVE 11° CLEARANCE TRIANGULAR INSERTS FOR MEDIUM MACHINING

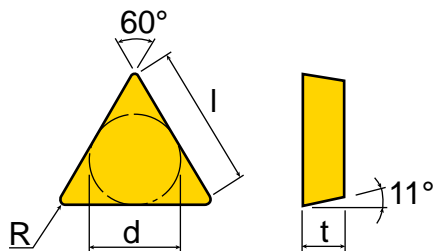

ANSI Number	ISO Number	feed (ipr)	ap (inch)	l	d	t	R
TPMR221	TPMR110304	.006 (.004-.010)	.059 (.028-.118)	0.394	0.250	0.125	0.016
TPMR222	TPMR110308	.007 (.005-.012)	.059 (.039-.118)	0.354	0.250	0.125	0.031
TPMR321	TPMR160304	.006 (.004-.010)	.079 (.039-.197)	0.610	0.375	0.125	0.016
TPMR322	TPMR160308	.007 (.005-.012)	.079 (.039-.197)	0.571	0.375	0.125	0.031
TPMR323	TPMR160312	.008 (.006-.014)	.079 (.039-.197)	0.531	0.375	0.125	0.047
TPMR431	TPMR220404	.006 (.004-.010)	.118 (.059-.276)	0.827	0.500	0.187	0.016
TPMR432	TPMR220408	.007 (.005-.012)	.118 (.059-.276)	0.787	0.500	0.187	0.031
TPMR433	TPMR220412	.008 (.006-.014)	.118 (.059-.276)	0.748	0.500	0.187	0.047
TPMR731	TPMR090204	.006 (.004-.010)	.039 (.020-.079)	0.339	0.219	0.094	0.016
TPMR732	TPMR090208	.007 (.005-.012)	.039 (.028-.079)	0.299	0.219	0.094	0.031

For use in holder CTAPR/L, CTCON, CTFPR/L, CTGPR/L, S-CTFPR/L, see pages 1045 - 1048, 1115.

Part Number	Grade	CT3000	P10	P20	PV3010	TT1300	TT5030	TT5100	TT7100	TT7310	TT8020	TT8115	TT8125						
TPMR221		●			●	●		●		●		●	●						
TPMR222		●			●			●				●	●						
TPMR321		●	●	●		●		●	●	●	●	●	●						
TPMR322		●			●		●	●		●	●	●	●						
TPMR323												●	●						
TPMR431								●					●						
TPMR432						●	●	●					●						
TPMR433																			
TPMR731												●	●						
TPMR732		●						●		●		●	●						

● = P ● = M ● = K ● = N ● = S ○ = H

TOTURN™ TPMT FG CHIPBREAKER

POSITIVE 11° CLEARANCE TRIANGULAR INSERTS FOR FINISHING

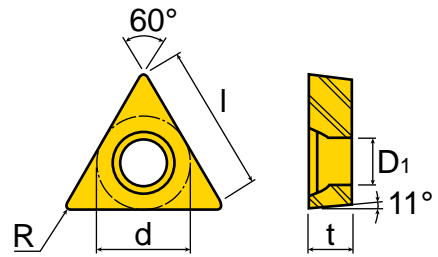

ANSI Number	ISO Number	feed (ipr)	ap (inch)	l	d	t	R	D1
TPMT221FG	TPMT110304FG	.004 (.003-.008)	.028 (.016-.059)	0.394	0.250	0.125	0.016	0.134

Part Number	Grade	CT3000	TT1300	TT5100	TT8020	TT8125												
		TPMT221FG																

● = P ● = M ● = K ● = N ● = S ○ = H

TOTURN™ TPMT PC CHIPBREAKER

POSITIVE 11° CLEARANCE TRIANGULAR INSERTS FOR MEDIUM MACHINING

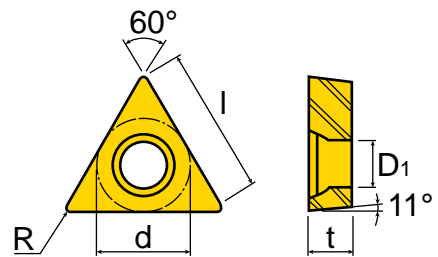

ANSI Number	ISO Number	feed (ipr)	ap (inch)	l	d	t	R	D1	Grade	TT5030	TT5100
TPMT21.51PC	TPMT110204PC	.005 (.002-.007)	.026 (.008-.098)	0.394	0.250	0.094	0.016	0.110			
TPMT21.52PC	TPMT110208PC	.007 (.004-.011)	.026 (.008-.098)	0.354	0.250	0.094	0.031	0.110			
TPMT32.51PC	TPMT16T304PC	.006 (.003-.009)	.031 (.010-.118)	0.610	0.375	0.156	0.016	0.073			
TPMT32.52PC	TPMT16T308PC	.008 (.004-.012)	.031 (.020-.118)	0.571	0.375	0.156	0.031	0.073			

For use in holder S-STFPR/L, see [page 1132](#).

● = P ● = M ● = K ● = N ● = S ○ = H

POSITIVE 11° CLEARANCE FLAT TOP TRIANGULAR INSERTS FOR MEDIUM MACHINING

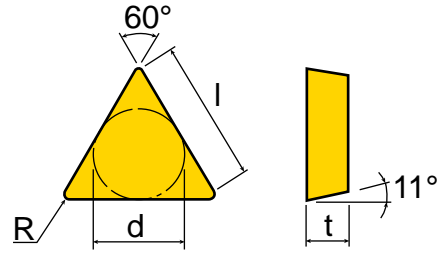

ANSI Number	ISO Number	feed (ipr)	ap (inch)	l	d	t	R
TPU221	TPUN110304	.008 (.004-.012)	.059 (.039-.118)	0.394	0.250	0.125	0.016
TPU222	TPU110308	.012 (.006-.016)	.059 (.039-.118)	0.354	0.250	0.125	0.031
TPU321	TPUN160304	.008 (.004-.012)	.079 (.039-.197)	0.610	0.375	0.125	0.016
TPU322	TPUN160308	.012 (.006-.016)	.079 (.039-.197)	0.571	0.375	0.125	0.031
TPU323	TPUN160312	.016 (.008-.020)	.079 (.059-.197)	0.531	0.375	0.125	0.047
TPU324	TPUN160316	.018 (.012-.022)	.079 (.059-.197)	0.492	0.375	0.125	0.063
TPU431	TPUN220404	.008 (.004-.012)	.118 (.059-.276)	0.827	0.500	0.187	0.016
TPU432	TPUN220408	.012 (.006-.016)	.118 (.059-.276)	0.787	0.500	0.187	0.031
TPU433	TPUN220412	.016 (.008-.020)	.118 (.059-.276)	0.748	0.500	0.187	0.047
TPU434	TPUN220416	.018 (.010-.022)	.118 (.059-.276)	0.709	0.500	0.187	0.063

For use in holder CTAPR/L, CTCON, CTFPR/L, CTGPR/L, S-CTFPR/L, see pages 1045 - 1048, 1115.

Part Number	Grade											
	CT3000	K10	M20	P20	P30	P40	TT1300	TT3500	TT7310	TT8020	TT8115	TT8125
TPU221		●	●	●	●		●				●	●
TPU222		●			●						●	●
TPU321	●	●			●		●				●	●
TPU322		●	●	●	●	●	●		●		●	●
TPU323			●		●		●	●			●	
TPU324					●							
TPU431											●	
TPU432	●	●		●	●							●
TPU433					●							
TPU434					●							

● = P ● = M ● = K ● = N ● = S ○ = H

TOTURN™ VBET R/L-GF CHIPBREAKER

POSITIVE 5° CLEARANCE 35 DEGREE RHOMBIC GROUND INSERTS FOR SMALL PARTS

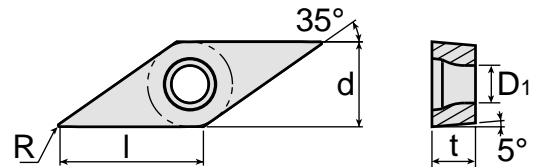

ANSI Number	ISO Number	feed (ipr)	ap (inch)	l	d	t	R	D1	Grade	TT9020
VBET220L-GF	VBET110301L-GF	.002 (.001-.006)	.024 (.008-.060)	0.425	0.250	0.125	0.004	0.110	●	
VBET220R-GF	VBET110301R-GF	.002 (.001-.006)	.024 (.008-.060)	0.425	0.250	0.125	0.004	0.110	●	
VBET220.5L-GF	VBET110302L-GF	.003 (.001-.007)	.031 (.012-.060)	0.417	0.250	0.125	0.008	0.110	●	
VBET220.5R-GF	VBET110302R-GF	.003 (.001-.007)	.031 (.012-.060)	0.417	0.250	0.125	0.008	0.110	●	
VBET221L-GF	VBET110304L-GF	.004 (.002-.008)	.031 (.012-.060)	0.390	0.250	0.125	0.016	0.110	●	
VBET221R-GF	VBET110304R-GF	.004 (.002-.008)	.031 (.012-.060)	0.390	0.250	0.125	0.016	0.110	●	

For use in holders SVJBR/L-SH, SVVBN-SH, see pages 1079, 1082.

● = P ● = M ● = K ● = N ● = S ○ = H

TOTURN™ VBET R/L-GW CHIPBREAKER

POSITIVE 5° CLEARANCE 35 DEGREE RHOMBIC GROUND INSERTS WITH WIPER GEOMETRY FOR SMALL PARTS

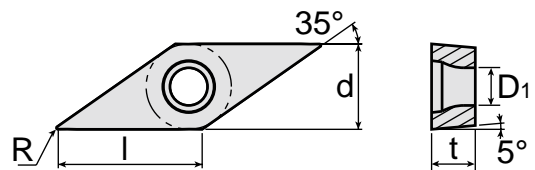
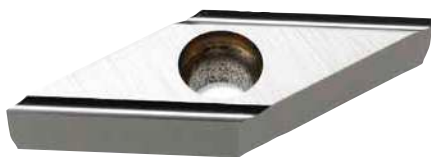

ANSI Number	ISO Number	feed (ipr)	ap (inch)	l	d	t	R	D1	Grade	TT9020
VBET22X0L-GW	VBET1103003L-GW	.003 (.001-.006)	.012 (.004-.060)	0.417	0.250	0.125	0.001	0.110	●	
VBET22X0R-GW	VBET1103003R-GW	.003 (.001-.006)	.012 (.004-.060)	0.417	0.250	0.125	0.001	0.110	●	

For use in holders SVJBR/L-SH, SVVBN-SH, see pages 1079, 1082.

● = P ● = M ● = K ● = N ● = S ○ = H

TOTURN™ VBMT FA CHIPBREAKER

POSITIVE 5° CLEARANCE 35 DEGREE RHOMBIC INSERTS FOR SUPER FINISHING

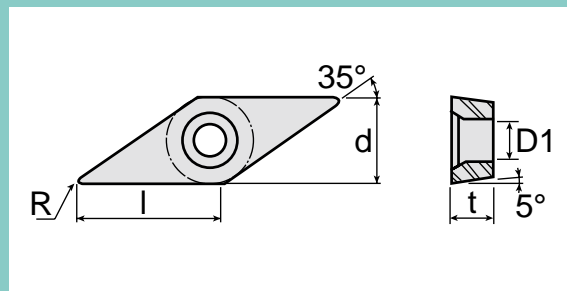

ANSI Number	ISO Number	feed (ipr)	ap (inch)	l	d	t	R	D1
VBMT332FA	VBMT160408FA	.005 (.002-.010)	.020 (.012-.040)	0.575	0.375	0.187	0.031	0.173

For use in holders SVJBR/L, S-SVQBR/L, see pages 1078, 1134.

Part Number	Grade	CT3000	PV3010	TT5030	TT5100	TT8115	TT8125										
VBMT332FA		●	●	●	●	●	●										

● = P ● = M ● = K ● = N ● = S ○ = H

TOTURN™ VBMT FG CHIPBREAKER

POSITIVE 5° CLEARANCE 35 DEGREE RHOMBIC INSERTS FOR FINISHING

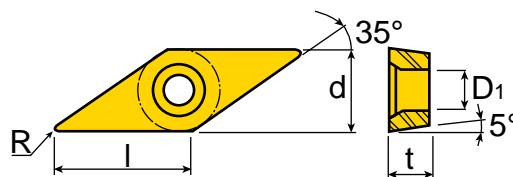

ANSI Number	ISO Number	feed (ipr)	ap (inch)	l	d	t	R	D1
VBMT331FG	VBMT160404FG	.004 (.003-.008)	.028 (.020-.059)	0.614	0.375	0.187	0.016	0.173
VBMT332FG	VBMT160408FG	.006 (.004-.010)	.039 (.028-.079)	0.575	0.375	0.187	0.031	0.173

For use in holders SVJBR/L, S-SVQBR/L, see pages 1078, 1134.

Part Number	Grade	CT3000	PV3010	TT5030	TT5100	TT8020	TT8115	TT8125	TT9225								
VBMT331FG		●●	●●	●●	●●	●●	●●	●●	●●								
VBMT332FG		●●		●●	●●		●●	●●	●●								

● = P ● = M ● = K ● = N ● = S ○ = H

TOTURN™ VBMT MT CHIPBREAKER

POSITIVE 5° CLEARANCE 35 DEGREE RHOMBIC INSERTS FOR MEDIUM MACHINING

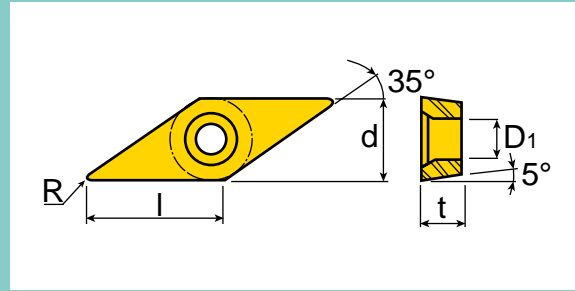
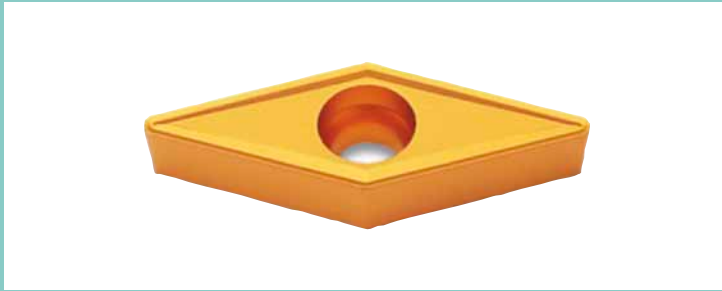

ANSI Number	ISO Number	feed (ipr)	ap (inch)	l	d	t	R	D1
VBMT331MT	VBMT160404MT	.006 (.004-.010)	.039 (.024-.118)	0.614	0.375	0.187	0.016	0.173
VBMT332MT	VBMT160408MT	.007 (.005-.012)	.059 (.035-.118)	0.575	0.375	0.187	0.031	0.173
VBMT333MT	VBMT160412MT	.009 (.006-.012)	.059 (.047-.118)	0.535	0.375	0.187	0.047	0.173

For use in holders SVJBR/L, S-SVQBR/L, see pages 1078, 1134.

Part Number	Grade	CT3000	PV3010	TT1300	TT5030	TT5100	TT7310	TT8020	TT8115	TT8125	TT9225							
VBMT331MT			●	●	●	●	●	●	●	●	●							
VBMT332MT		●		●	●	●	●	●	●	●	●							
VBMT333MT		●			●				●	●								

● = P ● = M ● = K ● = N ● = S ○ = H

TOTURN™ CCGT FL CHIPBREAKER

POSITIVE 7° CLEARANCE 80 DEGREE RHOMBIC INSERTS FOR ALUMINUM. GROUND AND VERY SHARP

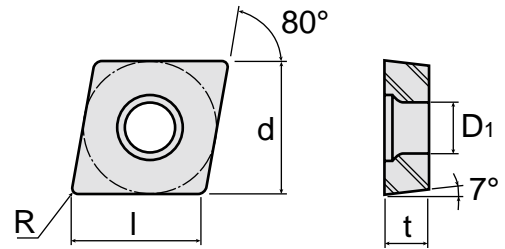

ANSI Number	ISO Number	l	d	t	R	D1	Grade	K10	TT6030
CCGT21.50.5FL	CCGT060202FL	0.244	0.250	0.094	0.008	0.110	●●●●●	●	●
CCGT21.51FL	CCGT060204FL	0.236	0.250	0.094	0.016	0.110	●●●●●	●	●
CCGT32.50.5FL	CCGT09T302FL	0.370	0.375	0.156	0.008	0.173	●●●●●	●	●
CCGT32.51FL	CCGT09T304FL	0.362	0.375	0.156	0.016	0.173	●●●●●	●	●
CCGT32.52FL	CCGT09T308FL	0.346	0.375	0.156	0.031	0.173	●●●●●	●	●
CCGT430.5FL	CCGT120402FL	0.496	0.500	0.187	0.008	0.217	●●●●●	●	●
CCGT431FL	CCGT120404FL	0.488	0.500	0.187	0.016	0.217	●●●●●	●	●
CCGT432FL	CCGT120408FL	0.472	0.500	0.187	0.031	0.217	●●●●●	●	●

For use in holders SCACR-SH, SCLCR/L, SCLCR-SH, E-SCLCR/L (CARBIDE), S-SCLCR/L, see pages 1064 - 1066, 1125, 1126.

● = P ● = M ● = K ● = N ● = S ○ = H

TOTURN™ DCGT FL CHIPBREAKER

POSITIVE 7° CLEARANCE 55 DEGREE RHOMBIC INSERTS FOR ALUMINUM. GROUND AND VERY SHARP

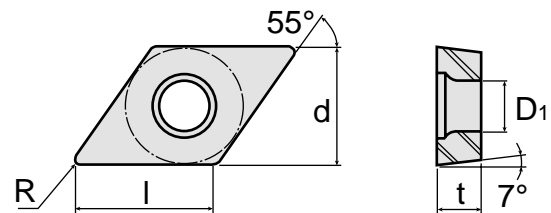

ANSI Number	ISO Number	l	d	t	R	D1	Grade	K10	
DCGT21.50.5FL	DCGT070202FL	0.295	0.250	0.094	0.008	0.110	●●●●●	●	●
DCGT21.51FL	DCGT070204FL	0.287	0.250	0.094	0.016	0.110	●●●●●	●	●
DCGT32.50.5FL	DCGT11T302FL	0.449	0.375	0.156	0.008	0.173	●●●●●	●	●
DCGT32.51FL	DCGT11T304FL	0.441	0.375	0.156	0.016	0.173	●●●●●	●	●
DCGT32.52FL	DCGT11T308FL	0.425	0.375	0.156	0.031	0.173	●●●●●	●	●

For use in holders SDJCR/L, SDJCR/L-SH, SDNCN-SH, SDPCN, E-SDUCR (CARBIDE), S-SDUCR/L, see pages 1067, 1068, 1070, 1071, 1128.

● = P ● = M ● = K ● = N ● = S ○ = H

TOTURN™ RCGT FL CHIPBREAKER

POSITIVE 7° CLEARANCE ANGLE ROUND INSERTS FOR ALUMINUM. GROUND AND VERY SHARP

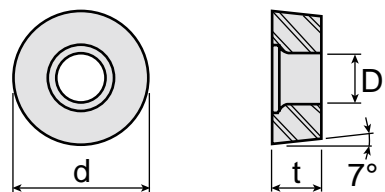

ANSI Number	ISO Number	l	d	t	R	D1	Grade	K10
RCGT0803MOFL	RCGT0803MOFL	-	0.315	0.125	-	0.110	●●●	●●●
RCGT1003MOFL	RCGT1003MOFL	-	0.393	0.125	-	0.173	●●●	●●●
RCGT10T3MOFL	RCGT10T3MOFL	-	0.393	0.156	-	0.173	●●●	●●●

For use in holders SRDCN & SRGCR/L, see pages 1072 & 1073.

● = P ● = M ● = K ● = N ● = S ○ = H

TOTURN™ SCGT FL CHIPBREAKER

POSITIVE 7° CLEARANCE ANGLE SQUARE INSERTS FOR ALUMINUM. GROUND AND VERY SHARP

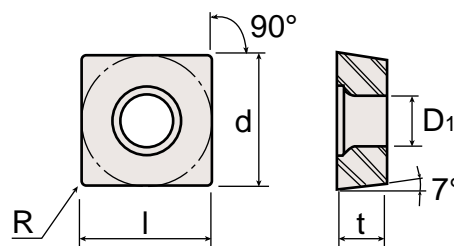
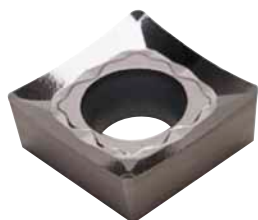

ANSI Number	ISO Number	l	d	t	R	D1	Grade	K10
SCGT32.52FL	SCGT09T308FL	0.343	0.375	0.156	0.031	0.173	●●●	●●●
SCGT431FL	SCGT120404FL	0.484	0.500	0.187	0.016	0.217	●●●	●●●
SCGT432FL	SCGT120408FL	0.469	0.500	0.187	0.031	0.217	●●●	●●●

For use in holder SSDCN, see page 1074.

● = P ● = M ● = K ● = N ● = S ○ = H

TOTURN™ TCGT FL CHIPBREAKER

POSITIVE 7° CLEARANCE TRIANGULAR INSERTS FOR ALUMINUM. GROUND AND VERY SHARP

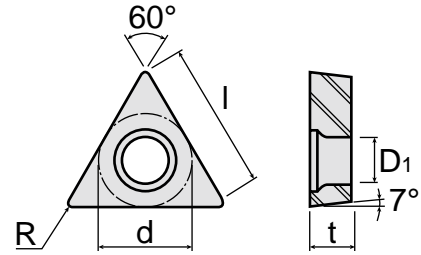

ANSI Number	ISO Number	l	d	t	R	D1	Grade	K10
TCGT731FL	TCGT090204FL	0.339	0.219	0.094	0.016	0.098	●●●	
TCGT21.51FL	TCGT110204FL	0.394	0.250	0.094	0.016	0.110	●●●	
TCGT32.51FL	TCGT16T304FL	0.610	0.375	0.156	0.016	0.173	●●●	
TCGT32.52FL	TCGT16T308FL	0.571	0.375	0.156	0.031	0.173	●●●	

For use in holders STFCR/L, STGCR/L, E-STFCR/L (CARBIDE), S-STFCR/L, S-STUCR/L, see page 1075, 1077, 1130 - 1132.

● = P ● = M ● = K ● = N ● = S ○ = H

TOTURN™ VCGT FL CHIPBREAKER

POSITIVE 7° CLEARANCE 35 DEGREE RHOMBIC INSERTS. GROUND AND VERY SHARP

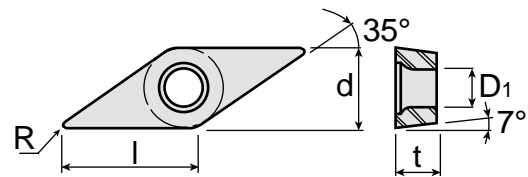

ANSI Number	ISO Number	l	d	t	R	D1	Grade	K10
VCGT220.5FL	VCGT110302FL	0.413	0.250	0.125	0.008	0.110	●●●	
VCGT221FL	VCGT110304FL	0.394	0.250	0.125	0.016	0.110	●●●	
VCGT330.5FL	VCGT160402FL	0.634	0.375	0.187	0.008	0.173	●●●	
VCGT331FL	VCGT160404FL	0.614	0.375	0.187	0.016	0.173	●●●	
VCGT332FL	VCGT160408FL	0.575	0.375	0.187	0.031	0.173	●●●	
VCGT333FL	VCGT160412FL	0.535	0.375	0.187	0.047	0.173	●●●	
VCGT43.57.5FL	VCGT220530FL	0.575	0.500	0.219	0.118	0.217	●●●	

For use in holders SVJCR/L, S-SVQCR/L, S-SVUCR/L, see page 1080, 1134, 1135.

● = P ● = M ● = K ● = N ● = S ○ = H

80 DEGREE RHOMBIC CERAMIC INSERTS

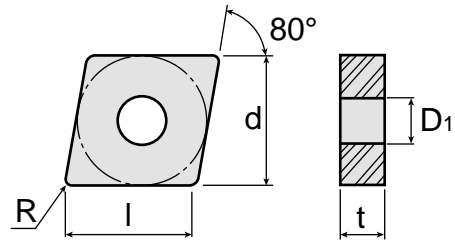

ANSI Number	ISO Number	l	d	t	R	D1
CNGA431	CNGA120404	0.488	0.500	0.187	0.016	0.203
CNGA431T2	CNGA120404T2	0.488	0.500	0.187	0.016	0.203
CNGA432	CNGA120408	0.472	0.500	0.187	0.031	0.203
CNGA432E	CNGA120408E	0.472	0.500	0.187	0.031	0.203
CNGA432T2	CNGA120408T2	0.472	0.500	0.187	0.031	0.203
CNGA433	CNGA120412	0.457	0.500	0.187	0.047	0.203
CNGA433T3	CNGA120412T3	0.457	0.500	0.187	0.047	0.203
CNGA434	CNGA120416	0.441	0.500	0.187	0.062	0.203
CNGA543	CNGA160612	0.583	0.625	0.250	0.047	0.250
CNGA642	CNGA190608	0.728	0.750	0.250	0.031	0.312

For use in holders MCLNR/L, TCKNR/L, TCLNR/L, TCMNN, TCRNR/L, S-MCLNR/L, A-TCLNR/L, see [pages 1049, 1084, 1086, 1088, 1089, 1116, 1137](#).

Part Number	Grade																			
	AB20	AB2010	AB30	AS10	AS20	SC10														
CNGA431	●	●	●																	
CNGA431T2																				
CNGA432	●	●	●	●			●													
CNGA432E					●															
CNGA432T2	●																			
CNGA433	●	●	●	●			●													
CNGA433T3																				
CNGA434			●	●																
CNGA543			●	●																
CNGA642			●																	

● = P ● = M ● = K ● = N ● = S ○ = H

80 DEGREE RHOMBIC CERAMIC INSERTS WITH WIPER

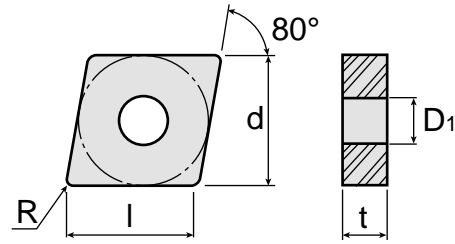

ANSI Number	ISO Number	l	d	t	R	D1	AB20	AB2010	AS10	SC10
CNGA432T6-WZ	CNGA120408T6-WZ	0.472	0.500	0.187	0.031	0.203			●	
CNGA433T6-WZ	CNGA120412T6-WZ	0.457	0.500	0.187	0.047	0.203			●	●
CNGA433T7-WZ	CNGA120412T7-WZ	0.457	0.500	0.187	0.047	0.203	◐	◐	●	●

For use in holders MCLNR/L, TCKNR/L, TCLNR/L, TCMNN, TCRNR/L, S-MCLNR/L, A-TCLNR/L, see pages 1049, 1084, 1086, 1088, 1089, 1116, 1137.

● = P ● = M ● = K ● = N ● = S ○ = H

80 DEGREE RHOMBIC CERAMIC INSERTS, NO HOLE

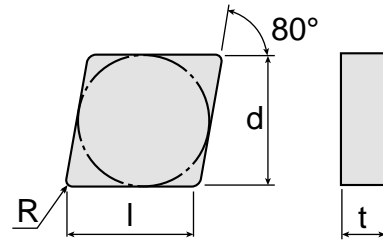
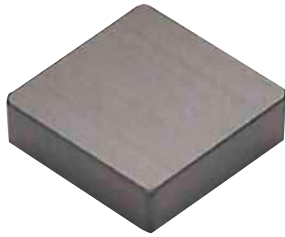

ANSI Number	ISO Number	l	d	t	R
CNG431	CNGN120404	0.488	0.500	0.187	0.016
CNG432	CNGN120408	0.472	0.500	0.187	0.031
CNG432E	CNGN120408E	0.472	0.500	0.187	0.031
CNG452	CNGN120708	0.472	0.500	0.313	0.031
CNG452E	CNGN120708E	0.472	0.500	0.313	0.031
CNG453	CNGN120712	0.457	0.500	0.313	0.047
CNG453E	CNGN120712E	0.457	0.500	0.313	0.047
CNG454	CNGN120716	0.441	0.500	0.313	0.062
CNG454E	CNGN120716E	0.441	0.500	0.313	0.062

For use in holder CCLNR/L, see [page 1103](#).

Part Number	Grade	AB20	AB2010	AB30	AS10	AS20	AW20	SC10											
CNG431				●															
CNG432		●	●	●															
CNG432E						●													
CNG452			●	●															
CNG452E						●													
CNG453				●			●	●											
CNG453E						●													
CNG454				●	●														
CNG454E						●													

● = P ● = M ● = K ● = N ● = S ○ = H

80 DEGREE RHOMBIC CERAMIC INSERTS, DIMPLE STYLE

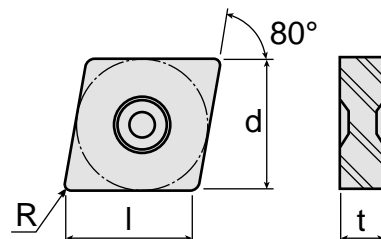

ANSI Number	ISO Number	l	d	t	R	D1	Grade	AS10	AS500
CNGX452T7-WZ	CNGX120708T7WZ	0.472	0.500	0.187	0.031	-		●	
CNGX453CH	CNGX120712CH	0.472	0.500	0.187	0.047	-		●	
CNGX453T7-CH	CNGX120712T7CH	0.472	0.500	0.187	0.047	-		●	●
CNGX453T7-WZ	CNGX120712T7WZ	0.472	0.500	0.187	0.047	-			
CNGX454CH	CNGX120716CH	0.441	0.500	0.187	0.062	-		●	
CNGX454T7-CH	CNGX120716T7CH	0.441	0.500	0.187	0.062	-			●

WZ-Denotes insert with wiper geometry.

For use in holders TCLNR/L-CH, S-TCLNR/L-CH, see pages 1111, 1142.

● = P ● = M ● = K ● = N ● = S ○ = H

TOTURN™ CNMG CE

80 DEGREE RHOMBIC CERAMIC INSERTS, PRESSED TO SIZE

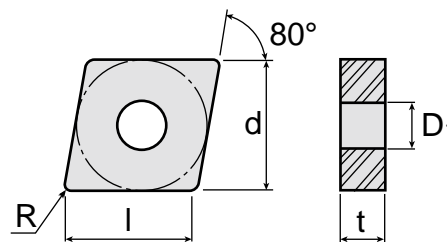

ANSI Number	ISO Number	l	d	t	R	D1	Grade	AB20	AB30
CNMG431CE	CNMG120404CE	0.488	0.500	0.313	0.016	0.203			●
CNMG432CE	CNMG120408CE	0.488	0.500	0.313	0.016	0.203		●	●

For use in holders MCLNR/L, TCKNR/L, TCLNR/L, TCMNN, TCRNR/L, S-MCLNR/L, A-TCLNR/L, see pages 1049, 1084, 1086, 1088, 1089, 1116, 1137.

● = P ● = M ● = K ● = N ● = S ○ = H

55 DEGREE RHOMBIC CERAMIC INSERTS

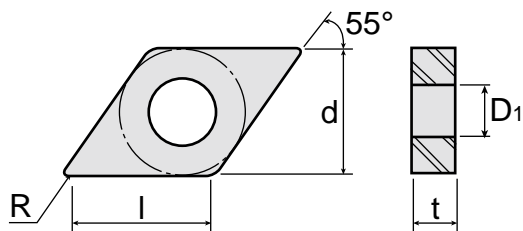

ANSI Number	ISO Number	l	d	t	R	D1	Grade				
							AB20	AB2010	AB30	AS10	AW20
DNGA431	DNGA150404	0.594	0.500	0.187	0.016	0.203	●		●		
DNGA432	DNGA150408	0.579	0.500	0.187	0.031	0.203	●	●	●		
DNGA432T6WZ	DNGA150408T6WZ	0.579	0.500	0.250	0.031	0.203					
DNGA441	DNGA150604	0.594	0.500	0.250	0.016	0.203	●				
DNGA442	DNGA150608	0.579	0.500	0.250	0.031	0.203	●	●		●	
DNGA443	DNGA150612	0.567	0.500	0.250	0.047	0.203	●			●	

WZ-Denotes insert with wiper geometry.

For use in holders MDJNR/L, MDQNR/L, TDJNR/L, TDNNN, TDQNR/L, A-TDUNR/L, see [pages 1050, 1051, 1090, 1091, 1138](#).

● = P ● = M ● = K ● = N ● = S ○ = H

55 DEGREE RHOMBIC CERAMIC INSERTS, DIMPLE STYLE

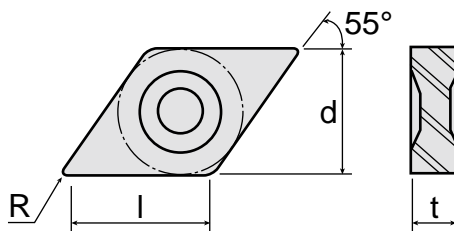

ANSI Number	ISO Number	l	d	t	R	Grade	
						AS10	AS500
DNGX120708T7-CH	DNGX120708T7-CH	0.437	0.394	0.313	0.031		●
DNGX120712T7-CH	DNGX120712T7-CH	0.413	0.394	0.313	0.047		
DNGX452T7-CH	DNGX150708T7-CH	0.579	0.500	0.313	0.031		
DNGX453CH	DNGX150712CH	0.567	0.500	0.313	0.047		●
DNGX453T7-CH	DNGX150712T7-CH	0.567	0.500	0.313	0.047		●
DNGX454CH	DNGX150716CH	0.551	0.500	0.313	0.062		●

For use in holder TDJNR/L-CH, see [page 1112](#).

● = P ● = M ● = K ● = N ● = S ○ = H

TOTURN™ DNMG CE

55 DEGREE RHOMBIC CERAMIC INSERTS, PRESSED TO SIZE

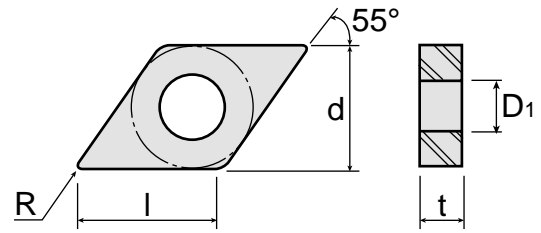

ANSI Number	ISO Number	l	d	t	R	D1	Grade	AS30
DNMG442CE	DNMG150608CE	0.579	0.500	0.250	0.031	0.203		●

For use in holders MDJNR/L, MDQNR/L, TDJNR/L, TDNNN, TDQNR/L, A-TDUNR/L, see pages 1050, 1051, 1090, 1091, 1138.

● = P ● = M ● = K ● = N ● = S ○ = H

TOTURN™ HNGX

HEXAGONAL CERAMIC INSERTS, DIMPLE STYLE

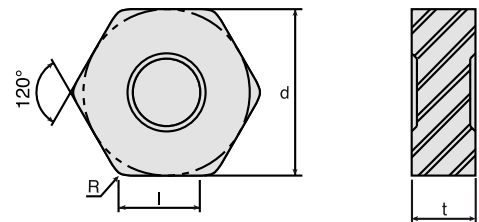

ANSI Number	ISO Number	feed (ipr)	ap (inch)	l	d	t	R	Grade	AS10	AS500
HNGX4537-CH	HNGX050712CH	.018 (.008-.031)	.118 (.012-.157)	0.260	0.500	0.313	0.047		●	●
HNGX4547-CH	HNGX050716CH	.021 (.008-.039)	.118 (.012-.157)	0.252	0.500	0.313	0.063		●	●

● = P ● = M ● = K ● = N ● = S ○ = H

POSITIVE 7 DEGREE, ROUND V-BOTTOM CERAMIC INSERTS

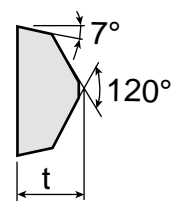
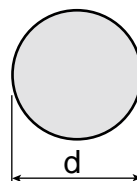

ANSI Number	ISO Number	d	t	Grade	AB20	AB30
RCGX24U1	RCGX060600U1	0.250	0.250			
RCGX35U1	RCGX090700U1	0.375	0.315			
RCGX45U2	RCGX120700U2	0.500	0.315			
RCGX57U2	RCGX151000U2	0.625	0.394			
RCGX67U2	RCGX191000U2	0.750	0.394			

● = P ● = M ● = K ● = N ● = S ○ = H

ROUND CERAMIC INSERTS

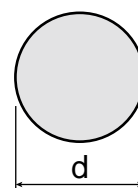

ANSI Number	ISO Number	d	t	Grade	AB20	AB2010	AB30	AS20
RNG32	RNGN 090300	0.750	0.125					
RNG43	RNGN120400	0.375	0.187					
RNG43E	RNGN120400E	0.500	0.187					
RNG45	RNGN 120700	0.500	0.313					
RNG45E	RNGN120700E	0.500	0.313					
RNG45T6	RNGN120700T6	0.500	0.313					
RNG45W2	RNGN120700W2	0.500	0.313					
RNG55	RNGN150700	0.625	0.313					
RNG65	RNGN190700	0.750	0.313					

For use in holders CRDNN & CRGNR/L, see pages 1104 & 1105.

● = P ● = M ● = K ● = N ● = S ○ = H

POSITIVE 11 DEGREE, ROUND V-BOTTOM CERAMIC INSERTS

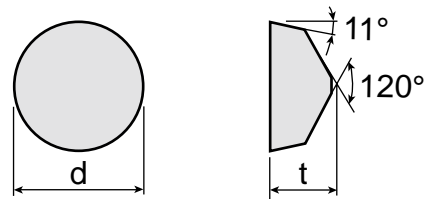

ANSI Number	ISO Number	d	t
RPGX35T6	RPGX090700T6	0.375	0.315
RPGX45T6	RPGX120700T6	0.500	0.315

● = P ● = M ● = K ● = N ● = S ○ = H

TOTURN™ SNGA

SQUARE CERAMIC INSERTS

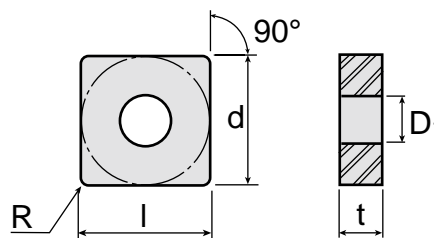

ANSI Number	ISO Number	l	d	t	R	D1	AB20	AB2010	AB30	AS10
SNGA431	SNGA120404	0.484	0.500	0.187	0.016	0.203	●	●	●	
SNGA432	SNGA120408	0.469	0.500	0.187	0.031	0.203	●	●	●	●
SNGA432E	SNGA120408E	0.469	0.500	0.187	0.031	0.203				
SNGA433	SNGA120412	0.531	0.500	0.187	0.047	0.203	●	●	●	

For use in holders MSDNN, MSRNR/L, MSSNR/L, TSDNN, TSKNR/L, TSRNR/L, TSSNR/L, S-MSKNR/L, see pages 1053 - 1055, 1094 - 1097, 1118.

● = P ● = M ● = K ● = N ● = S ○ = H

SQUARE CERAMIC INSERTS, NO HOLE

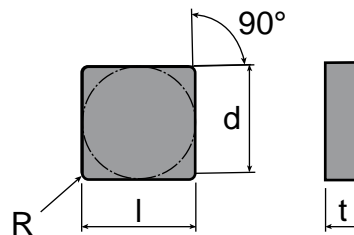

ANSI Number	ISO Number	l	d	t	R
SNG431	SNGN 120404	0.484	0.500	0.187	0.016
SNG432	SNGN 120408	0.469	0.500	0.187	0.031
SNG432E	SNGN 120408E	0.469	0.500	0.187	0.031
SNG433	SNGN 120412	0.453	0.500	0.187	0.047
SNG434	SNGN 120416	0.437	0.500	0.187	0.062
SNG452	SNGN 120708	0.469	0.500	0.313	0.031
SNG453	SNGN 120712	0.453	0.500	0.313	0.047
SNG454	SNGN 120716	0.437	0.500	0.313	0.062

For use in holders CSDNN, CSKNR/L, CSRNR/L, CSSNR/L, see pages 1106 - 1109.

Part Number	Grade	AB20	AB2010	AB30	AS10	AS20	AW20	SC10												
SNG431		●	●	●																
SNG432		●	●	●																
SNG432E					●	●														
SNG433		●	●	●	●			●	●											
SNG434		●	●	●	●				●											
SNG452		●	●																	
SNG453		●	●	●				●												
SNG454				●	●			●												

● = P ● = M ● = K ● = N ● = S ○ = H

SQUARE CERAMIC INSERTS, DIMPLE STYLE

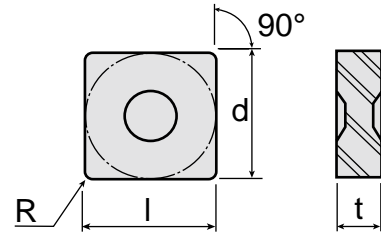

ANSI Number	ISO Number	l	d	t	R	Grade	AS10	AS500	SC10		
SNGX453CH	SNGX120712CH	0.453	0.500	0.313	0.047						
SNGX453T7-CH	SNGX120712T7-CH	0.453	0.500	0.313	0.047		●	●			
SNGX454CH	SNGX120716CH	0.437	0.500	0.313	0.063		●		●		
SNGX454T7-CH	SNGX120716T7-CH	0.437	0.500	0.313	0.063			●			
SNGX554T7-CH	SNGX150716T7-CH	0.591	0.625	0.313	0.063		●				

For use in holder TSSNR/L-CH, see [page 1113](#).

● = P ● = M ● = K ● = N ● = S ○ = H

SQUARE CERAMIC INSERTS, PRESSED TO SIZE

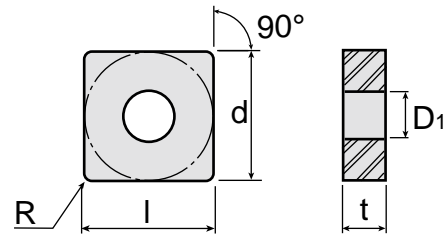

ANSI Number	ISO Number	l	d	t	R	D1	Grade	AB30
SNMG432CE	SNMG120408CE	0.469	0.500	0.187	0.031	0.203		●

For use in holders MSDNN, MSRNR/L, MSSNR/L, TSDNN, TSKNR/L, TSRNR/L, TSSNR/L, S-MSKNR/L, see [pages 1053 - 1054, 1094 - 1097, 1118](#).

● = P ● = M ● = K ● = N ● = S ○ = H

POSITIVE 11 DEGREE SQUARE CERAMIC INSERTS

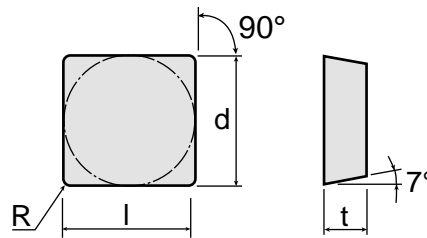

ANSI Number	ISO Number	l	d	t	R	Grade	AS10	K20			
SPG433	SPGN120412	0.453	0.500	0.187	0.047		●	●			

For use in holder CSDPN, see page 1044.

● = P ● = M ● = K ● = N ● = S ○ = H

TOTURN™ TNGA

TRIANGLE CERAMIC INSERTS

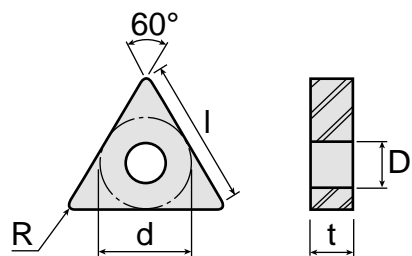

ANSI Number	ISO Number	l	d	t	R	D1	Grade	AB20	AB2010	AB30	AS10	AS20
TNGA331	TNGA160404	0.610	0.375	0.187	0.016	0.150		●	●	●		
TNGA332	TNGA160408	0.571	0.375	0.187	0.031	0.150		●	●	●	●	
TNGA332E	TNGA160408E	0.571	0.375	0.187	0.031	0.150						●
TNGA333	TNGA160412	0.531	0.375	0.187	0.047	0.150		●	●	●	●	
TNGA432	TNGA220408	0.787	0.500	0.187	0.031	0.150		●	●	●		

For use in holders MTCNN, MTENN, MTFNR/L, MTGNR/L, MTJNR/L, TTFNR/L, TTJNR/L, S-MTFNR/L, S-MTUNR/L, A-TTFNR/L, see pages 1056 - 1060, 1098, 1099, 1119, 1120, 1140.

● = P ● = M ● = K ● = N ● = S ○ = H

TRIANGLE CERAMIC INSERTS, NO HOLE

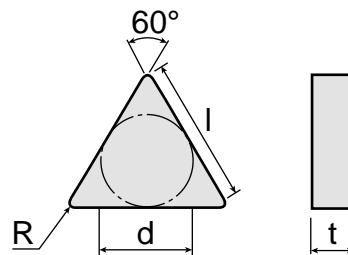

ANSI Number	ISO Number	l	d	t	R	Grade	AB20	AB2010	AB30	AS10	AW20
TNG331	TNGN 160404	0.610	0.375	0.187	0.016						
TNG332	TNGN 160408	0.571	0.375	0.187	0.031		●	●	●	●	●
TNG332E	TNGN160408E	0.571	0.375	0.187	0.031						
TNG333	TNGN160412	0.531	0.375	0.187	0.047		●		●	●	●
TNG351	TNGN160704	0.531	0.375	0.313	0.016				●		
TNG352	TNGN160708	0.571	0.375	0.313	0.016				●		

For use in holder CTJNR, see [page 1110](#).

● = P ● = M ● = K ● = N ● = S ○ = H

TRIANGLE CERAMIC INSERTS, PRESSED TO SIZE

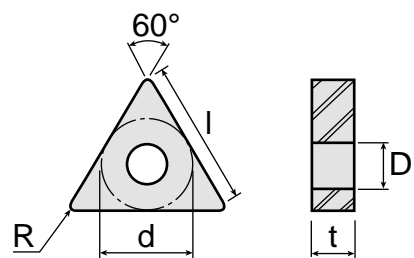

ANSI Number	ISO Number	l	d	t	R	D1	AB30
TNMG332CE	TNMG160408CE	0.570	0.375	0.187	0.031	0.150	●

For use in holders MTCNN, MTENN, MTFNR/L, MTGNR/L, MTJNR/L, TTFNR/L, TTJNR/L, S-MTFNR/L, S-MTUNR/L, A-TTFNR/L, see [pages 1056 - 1060, 1098, 1099, 1119, 1120, 1140](#).

● = P ● = M ● = K ● = N ● = S ○ = H

POSITIVE 11 DEGREE TRIANGLE CERAMIC INSERTS

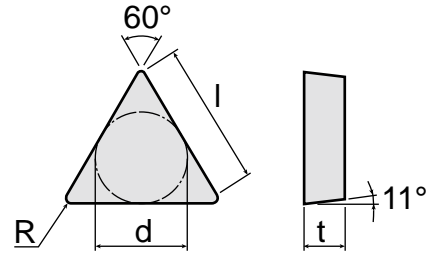

ANSI Number	ISO Number	l	d	t	R	Grade	AB20	AB2010	AB30		
TPG221	TPGN 110304	0.394	0.250	0.125	0.016						
TPG222	TPGN 110308	0.354	0.250	0.125	0.031						
TPG321	TPGN 160304	0.610	0.375	0.125	0.016						
TPG322	TPGN 160308	0.571	0.375	0.125	0.031						

For use in holders CTAPR/L, CTCON, CTFPR/L, CTGPR/L, S-CTFPR/L, see pages 1045 - 1048, 1115.

● = P ● = M ● = K ● = N ● = S ○ = H

TOTURN™ VNGA

35 DEGREE RHOMBIC CERAMIC INSERTS

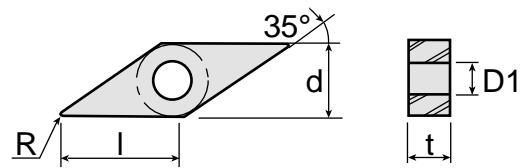

ANSI Number	ISO Number	l	d	t	R	D1	Grade	AB20	AB2010	AB30		
VNGA331	VNGA160404	0.610	0.375	0.187	0.016	0.150						
VNGA332	VNGA160408	0.571	0.375	0.187	0.031	0.150						
VNGA332E	VNGA160408E	0.571	0.375	0.187	0.031	0.150						

For use in holders TVJNR/L, TVQNR/L, TVVNN, S-MVUNR/L, S-MVXNR/L, see pages 1100, 1101, 1121, 1122.

● = P ● = M ● = K ● = N ● = S ○ = H

35 DEGREE RHOMBIC CERAMIC INSERTS, DIMPLE STYLE

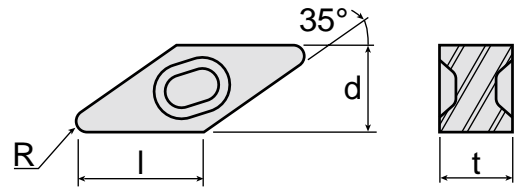

ANSI Number	ISO Number	l	d	t	R	Grade
VNGX353T7-CH	VNGX160712T7-CH	0.535	0.375	0.313	0.047	

● = P ● = M ● = K ● = N ● = S ○ = H

80 DEGREE TRIGON CERAMIC INSERTS

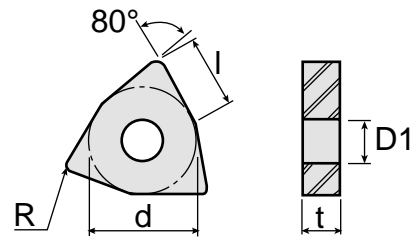

ANSI Number	ISO Number	l	d	t	R	D1	AB20	AB2010	AB30	AS10	SC10
WNGA432	WNGA 080408	0.331	0.500	0.187	0.031	0.203	●	●	●	●	●
WNGA433	WNGA 080412	0.323	0.500	0.187	0.047	0.203	●	●	●	●	●
WNGA434	WNGA 080416	0.319	0.500	0.187	0.062	0.203					

For use in holders MWLNR/L, TWLNR/L, A-TWLNR/L, see [pages 1063, 1102, 1141](#).

● = P ● = M ● = K ● = N ● = S ○ = H

80 DEGREE TRIGON CERAMIC INSERTS WITH WIPER GEOMETRY

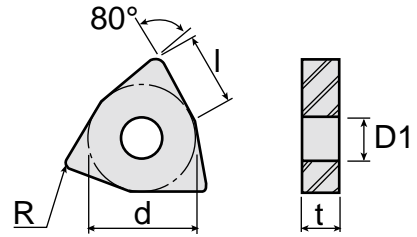

ANSI Number	ISO Number	l	d	t	R	D1	Grade	AB20	AB2010
WNGA432T7-WZ	WNGA080408T7-WZ	0.331	0.500	0.187	0.031	0.203			
WNGA433T7-WZ	WNGA080412T7-WZ	0.323	0.500	0.187	0.047	0.203			

For use in holders MWLNR/L, TWLNR/L, A-TWLNR/L, see pages 1063, 1102, 1141.

● = P ● = M ● = K ● = N ● = S ○ = H

TOTURN™ T11-3219

POSITIVE 6 DEGREE CLEARANCE ROUND CERAMIC INSERTS FOR ROLL MACHINING

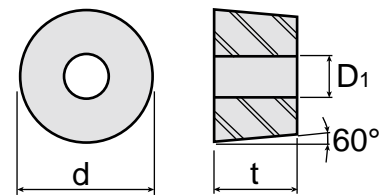

ANSI Number	ISO Number	l	d	t	R	D1	AB20
T11-3219	T11-3219	1.256	-	0.750	-	0.394	

● = P ● = M ● = K ● = N ● = S ○ = H

POSITIVE 7 DEG CLEARANCE, 80 DEG RHOMBIC CBN TIPPED INSERTS

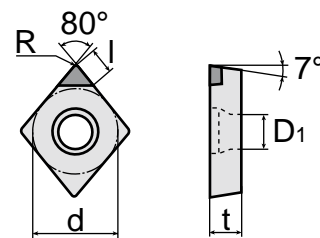

ANSI Number	ISO Number	l	d	t	R	D1	KB50	KB90	TB650
CCGW21.50.5LS	CCGW060202LS	0.094	0.250	0.094	0.008	0.110			
CCGW21.51LS	CCGW060204LS	0.094	0.250	0.094	0.016	0.110			
CCGW32.51LS	CCGW09T304LS	0.094	0.375	0.156	0.016	0.173			
CCGW32.51WZ-LS	CCGW 09T304WZ-LS	0.094	0.375	0.156	0.016	0.173			
CCGW32.51WZ-LS2	CCGW 09T304WZ-LS2	0.094	0.375	0.156	0.016	0.173			
CCGW32.52LS	CCGW09T308LS	0.094	0.375	0.156	0.031	0.173			
CCGW32.52WZ-LS	CCGW09T308WZ-LS	0.094	0.375	0.156	0.031	0.173			
CCGW431LS	CCGW120404LS	0.102	0.500	0.187	0.016	0.217			

LS-Single Tip, LS2-Double Tip
 For use in holders SCACR-SH, SCLCR/L, SCLCR-SH, E-SCLCR/L (CARBIDE), S-SCLCR/L,
 see pages 1064- 1066, 1125, 1126.

= P = M = K = N = S = H

80 DEGREE RHOMBIC CBN TIPPED INSERTS

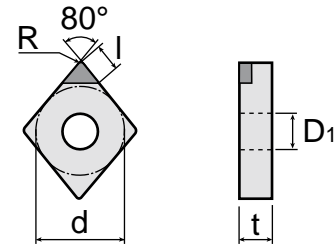

ANSI Number	ISO Number	l	d	t	R	D1	Grade	KB50	KB90	TB650
CNMA431LN	CNMA120404LN	0.157	0.500	0.187	0.016	0.203				
CNMA431LS	CNMA120404LS	0.102	0.500	0.187	0.016	0.203				
CNMA431LS2	CNMA120404LS2	0.102	0.500	0.187	0.016	0.203				
CNMA431LS4	CNMA120404LS4	0.102	0.500	0.187	0.016	0.203				
CNMA432LN	CNMA120408LN	0.154	0.500	0.187	0.031	0.203				
CNMA432LS	CNMA120408LS	0.098	0.500	0.187	0.031	0.203				
CNMA432LS2	CNMA120408LS2	0.098	0.500	0.187	0.031	0.203				
CNMA432LS4	CNMA120408LS4	0.098	0.500	0.187	0.031	0.203				
CNMA433LN	CNMA120412LN	0.150	0.500	0.187	0.047	0.203				
CNMA433LS	CNMA120412LS	0.094	0.500	0.187	0.047	0.203				
CNMA433LS2	CNMA120412LS2	0.094	0.500	0.187	0.047	0.203				

LS-Single Tip, LS2-Double Tip, LS4-Four Tip, LN-Single Long Tip
 For use in holders MCLNR/L, TCKNR/L, TCLNR/L, TCMNN, TCRNR/L, S-MCLNR/L, A-TCLNR/L,
 see pages 1049, 1084, 1086, 1088, 1089, 1116, 1137.

= P = M = K = N = S = H

80 DEGREE RHOMBIC CBN TIPPED INSERTS WITH WIPER GEOMETRY

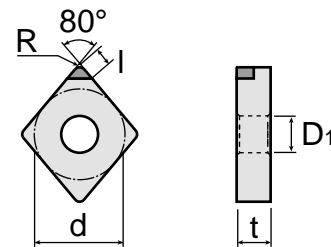
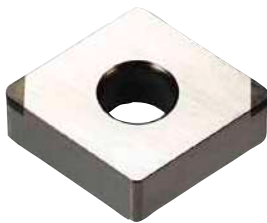

ANSI Number	ISO Number	l	d	t	R	D1	Grade	KB50	KB90	TB650
CNGA431WZ-LS	CNGA120404WZ-LS	0.102	0.500	0.187	0.016	0.203				
CNGA431WZ-LS2	CNGA120404WZ-LS2	0.102	0.500	0.187	0.016	0.203				
CNGA432WZ-LS	CNGA120408WZ-LS	0.098	0.500	0.187	0.031	0.203				
CNGA432WZ-LS2	CNGA120408WZ-LS2	0.098	0.500	0.187	0.031	0.203				
CNGA433WZ-LS	CNGA120412WZ-LS	0.106	0.500	0.047	0.047	0.203				
CNGA433WZ-LS2	CNGA120412WZ-LS2	0.106	0.500	0.187	0.047	0.203				

LS-Single Tip, LS2-Double Tip
 For use in holders MCLNR/L, TCKNR/L, TCLNR/L, TCMNN, TCRNR/L, S-MCLNR/L, A-TCLNR/L,
 see pages 1049, 1084, 1086, 1088, 1089, 1116, 1137.

= P = M = K = N = S = H

80 DEGREE RHOMBIC, SOLID CBN INSERTS

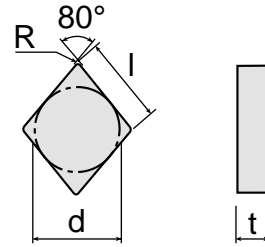

ANSI Number	ISO Number	l	d	t	R	Grade	KE90A
CNM322SD	CNMN090308SD	0.346	0.375	0.125	0.031	●	●
CNM323SD	CNMN090312SD	0.331	0.375	0.125	0.047	●	●
CNM324SD	CNMN090316SD	0.315	0.375	0.125	0.062	●	●
CNMN322SD	CNMN090308SD	0.346	0.375	0.125	0.031		
CNMN323SD	CNMN090312SD	0.331	0.375	0.125	0.047		

● = P ● = M ● = K ● = N ● = S ○ = H

POSITIVE 7 DEG CLEARANCE, 55 DEGREE RHOMBIC CBN TIPPED INSERTS

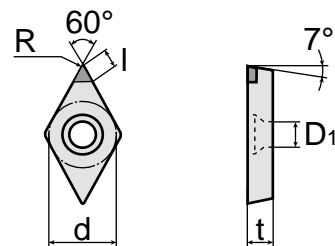
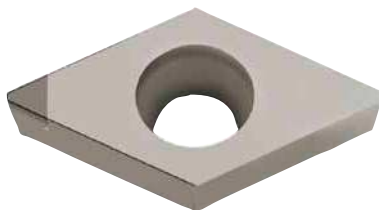

ANSI Number	ISO Number	l	d	t	R	D1	KB50	KB90	TB450 Grade
DCGW21.50.5LS	DCGW070202LS	0.102	0.250	0.094	0.008	0.110	●	●	○
DCGW21.51LS	DCGW070204LS	0.094	0.250	0.094	0.016	0.110	●	●	○
DCGW21.52LS	DCGW070208LS	0.094	0.250	0.094	0.031	0.110	●		
DCGW32.51LS	DCGW11T304LS	0.102	0.250	0.094	0.016	0.173	●	●	○
DCGW32.52LS	DCGW11T308LS	0.087	0.250	0.094	0.031	0.173	●	●	○

LS-Single Tip
 For use in holders SDJCR/L, SDJCR/L-SH, SDNCN-SH, SDPCN, E-SDUCR (CARBIDE), S-SDUCR/L,
 see pages 1067, 1068, 1070, 1071, 1128.

● = P ● = M ● = K ● = N ● = S ○ = H

55 DEGREE RHOMBIC CBN-TIPPED INSERTS

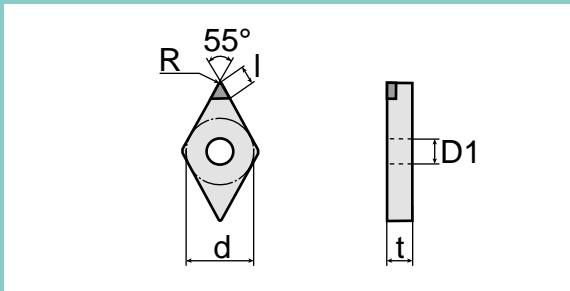

ANSI Number	ISO Number	l	d	t	R	D1	Grade	KB50	KB90	TB650
DNMA431LN	DNMA150404LN	0.161	0.500	0.187	0.016	0.203	●	●	●	●
DNMA431LS	DNMA150404LS	0.118	0.500	0.187	0.016	0.203	●	●	●	●
DNMA431LS2	DNMA150404LS2	0.118	0.500	0.187	0.016	0.203	●	●	●	●
DNMA431LS4	DNMA150404LS4	0.118	0.500	0.187	0.016	0.203	●	●	●	●
DNMA432LN	DNMA150408LN	0.150	0.500	0.187	0.031	0.203	●	●	●	●
DNMA432LS	DNMA150408LS	0.102	0.500	0.187	0.031	0.203	●	●	●	●
DNMA432LS2	DNMA150408LS2	0.102	0.500	0.187	0.031	0.203	●	●	●	●
DNMA433LN	DNMA150412LN	0.130	0.500	0.187	0.047	0.203	●	●	●	●
DNMA441LN	DNMA150604LN	0.161	0.500	0.250	0.016	0.203	●	●	●	●
DNMA441LS	DNMA150604LS	0.118	0.500	0.250	0.016	0.203	●	●	●	●
DNMA441LS2	DNMA150604LS2	0.118	0.500	0.250	0.016	0.203	●	●	●	●
DNMA441WZ-LS	DNMA150604WZ-LS	0.102	0.500	0.250	0.016	0.203	●	●	●	●
DNMA442LN	DNMA150608LN	0.150	0.500	0.250	0.031	0.203	●	●	●	●
DNMA442WZ-LN	DNMA150608WZ-LN	0.142	0.500	0.250	0.031	0.203	●	●	●	●

LS-Single Tip, LS2-Double Tip, LS4-Four Tip, LN-Single Long Tip
 For use in holders MDJNR/L, MDQNR/L, TDJNR/L, TDNNN, TDQNR/L, A-TDUNR/L,
 see pages 1050, 1051, 1090, 1091, 1138.

● = P ● = M ● = K ● = N ● = S ○ = H

TOTURN™ RCGX FT

POSITIVE 7 DEGREE, ROUND, V-BOTTOM, FULL-TOP CBN INSERTS

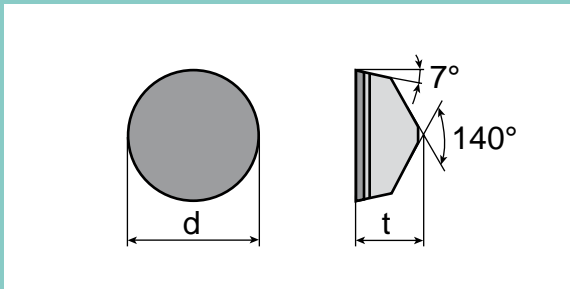

ANSI Number	ISO Number	l	d	t	R	Grade	KB90
RCGX22FT	RCGX060300FT	-	0.250	0.125	-	●	●
RCGX32FT	RCGX090300FT	-	0.375	0.125	-	●	●
RCGX43FT	RCGX120400FT	-	0.500	0.187	-	●	●

● = P ● = M ● = K ● = N ● = S ○ = H

ROUND, FULL-TOP CBN INSERTS

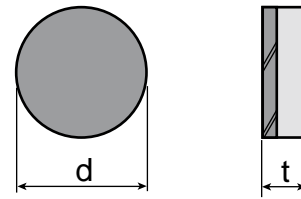

ANSI Number	ISO Number	l	d	t	R	Grade	KB90
RNM32FT	RNMN090300FT	-	0.375	0.125	-		
RNM42FT	RNMN120300FT	-	0.500	0.125	-		

● = P ● = M ● = K ● = N ● = S ○ = H

ROUND, SOLID CBN INSERTS

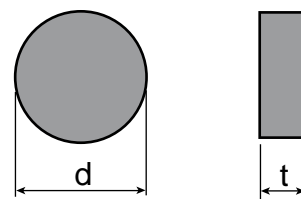

ANSI Number	ISO Number	l	d	t	R	Grade	KB90A
RNM32SD	RNMN090300SD	-	0.375	0.125	-		
RNM42SD	RNMN120300SD	-	0.500	0.125	-		

● = P ● = M ● = K ● = N ● = S ○ = H

SQUARE CBN-TIPPED INSERTS, NO HOLE

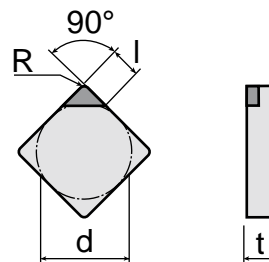
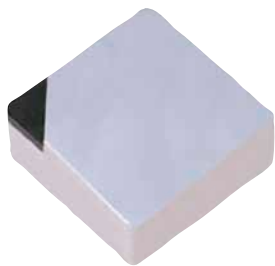

ANSI Number	ISO Number	l	d	t	R	Grade	TB650
SNG432LN	SNGN120408LN	0.157	0.500	0.187	0.031	●	●
SNG433LN	SNGN120412LN	0.157	0.500	0.187	0.047	●	●

For use in holders CSDNN, CSKNR/L, CSRNR/L, CSSNR/L, see pages 1106 - 1109.

● = P ● = M ● = K ● = N ● = S ○ = H

SQUARE CBN-TIPPED INSERTS

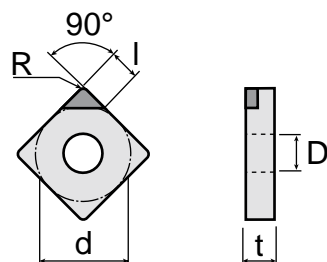
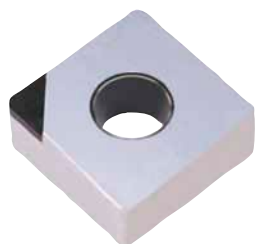

ANSI Number	ISO Number	l	d	t	R	D1	Grade	KB90	TB650
SNMA431LN	SNMA120404LN	0.157	0.500	0.187	0.016	0.203	●	●	●
SNMA432LN	SNMA120408LN	0.157	0.500	0.187	0.031	0.203	●	●	●

For use in holders MSDNN, MSNR/L, MSSNR/L, TSDNN, TSKNR/L, TSRNR/L, TSSNR/L, S-MSKNR/L, see pages 1053 - 1055, 1094 - 1097, 1118.

● = P ● = M ● = K ● = N ● = S ○ = H

SQUARE, SOLID CBN INSERTS

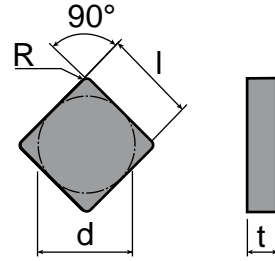

ANSI Number	ISO Number	l	d	t	R	Grade	KB90A
SNM322SD	SNMN090308SD	0.343	0.375	0.125	0.031	●	●
SNM323SD	SNMN090312SD	0.327	0.375	0.125	0.047	●	●
SNM324SD	SNMN090316SD	0.311	0.375	0.125	0.063	●	●
SNM423SD	SNMN120312SD	0.453	0.500	0.125	0.047	●	●
SNM424SD	SNMN120316SD	0.437	0.500	0.125	0.063	●	●

For use in holders CSDNN, CSKNR/L, CSRNR/L, CSSNR/L, see pages 1106 - 1109.

● = P ● = M ● = K ● = N ● = S ○ = H

POSITIVE 7 DEG CLEARANCE, TRIANGLE CBN-TIPPED INSERTS

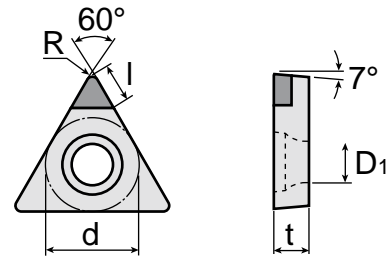
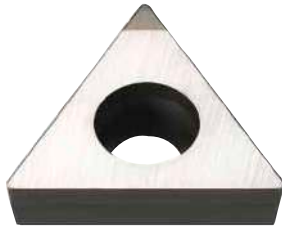

ANSI Number	ISO Number	l	d	t	R	D1	KB50	KB90	TB450 Grade
TCGW21.51LS	TCGW110204LS	0.102	0.250	0.094	0.016	0.110	●	●	●
TCGW21.52LS	TCGW110208LS	0.091	0.250	0.094	0.031	0.110	●	●	●
TCGW32.51LS	TCGW16T304LS	0.110	0.375	0.156	0.016	0.173	●	●	●
TCGW32.52LS	TCGW16T308LS	0.098	0.375	0.156	0.031	0.173	●	●	●

For use in holders STFCL/L, STGCR/L, E-STFCR/L (CARBIDE), S-STFCR/L, S-STUCR/L, see pages 1075, 1076, 1130 - 1132.

● = P ● = M ● = K ● = N ● = S ○ = H

TRIANGULAR, CBN-TIPPED INSERTS

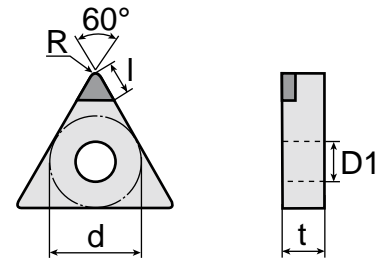

ANSI Number	ISO Number	l	d	t	R	D1	Grade	KB50	KB90	TB650
TNMA331LN	TNMA160404LN	0.157	0.375	0.187	0.016	0.150				
TNMA331LS	TNMA160404LS	0.110	0.375	0.187	0.016	0.150				
TNMA332LN	TNMA160408LN	0.150	0.375	0.187	0.031	0.150				
TNMA332LS	TNMA160408LS	0.098	0.375	0.187	0.031	0.150				
TNMA332LS3	TNMA160408LS3	0.098	0.375	0.187	0.031	0.150				
TNMA432LS	TNMA220408LS	0.102	0.500	0.187	0.031	0.203				

LS-Single Tip, LS2-Double Tip, LN-Single Long Tip

For use in holders MTCNN, MTENN, MTFNR/L, MTGNR/L, MTJNR/L, TTFNR/L, TTJNR/L, S-MTFNR/L, S-MTUNR/L, A-TTFNR/L, see pages 1056 - 1059, 1098, 1099, 1119, 1120, 1140.

= P = M = K = N = S = H

POSITIVE 11 DEG CLEARANCE, TRIANGULAR CBN TIPPED INSERTS, NO HOLE

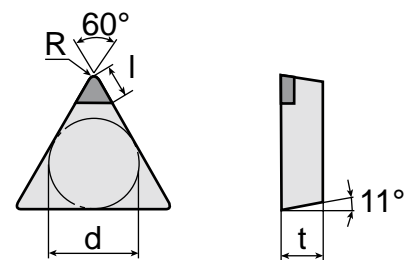
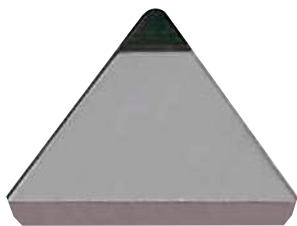

ANSI Number	ISO Number	l	d	t	R	Grade	KB50	KB90	TB650
TPG221LS	TPGN110304LS	0.102	0.250	0.125	0.016				
TPG222LS	TPGN110308LS	0.091	0.250	0.125	0.031				
TPG321LS	TPGN160304LS	0.110	0.375	0.125	0.016				
TPG322LS	TPGN160308LS	0.098	0.375	0.125	0.031				
TPG432LS	TPGN220408LS	0.102	0.500	0.187	0.031				

For use in holders CTAPR/L, CTCON, CTFPR/L, CTGPR/L, S-CTFPR/L, see pages 1045 - 1047, 1048, 1115.

= P = M = K = N = S = H

TOTURN™ VBGW LN/LS

POSITIVE 5 DEG CLEARANCE, 35 DEG RHOMBIC CBN TIPPED INSERTS

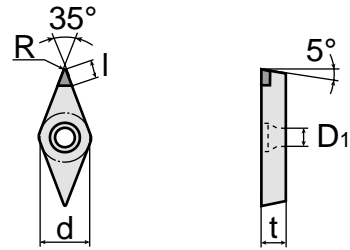

ANSI Number	ISO Number	l	d	t	R	D1	Grade	KB50	KB90	TB650		
VBGW331LN	VBGW160404LN	0.197	0.375	0.187	0.016	0.173						
VBGW331LS	VBGW160404LS	0.126	0.375	0.187	0.016	0.173						
VBGW332LS	VBGW160408LS	0.102	0.375	0.187	0.031	0.173						

LS-Single Tip, LN-Single Long Tip

For use in holders SVJBR/L, S-SVQBR/L, see [pages 1078, 1134](#).

● = P ● = M ● = K ● = N ● = S ○ = H

TOTURN™ VNGA LN/LS

35 DEGREE RHOMBIC CBN TIPPED INSERTS

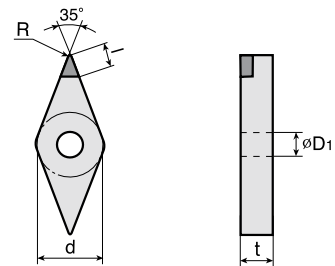

ANSI Number	ISO Number	l	d	t	R	D1	Grade	KB50	KB90	TB650		
VNGA331LN	VNGA160404LN	0.189	0.375	0.187	0.016	0.150						
VNGA331LS	VNGA160404LS	0.126	0.375	0.187	0.016	0.150						
VNGA332LN	VNGA160408LN	0.156	0.375	0.187	0.031	0.150						
VNGA332LS	VNGA160408LS	0.091	0.375	0.187	0.031	0.150						
VNGA332LS2	VNGA160408LS2	0.091	0.375	0.187	0.031	0.150						

LS-Single Tip, LS2-Double Tip, LN-Single Long Tip

For use in holders TVJNR/L, TVQNR/L, TVVNN, S-MVUNR/L, S-MVXNR/L, see [pages 1100, 1101, 1121, 1122](#).

● = P ● = M ● = K ● = N ● = S ○ = H

80 DEGREE TRIGON, CBN TIPPED INSERTS

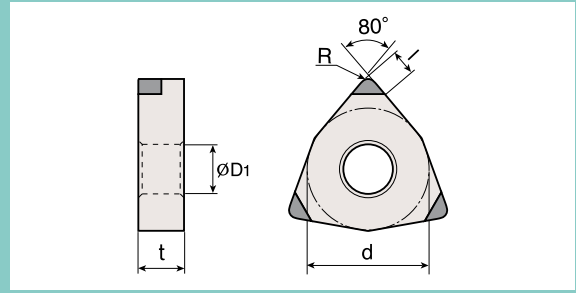

ANSI Number	ISO Number	l	d	t	R	D1	Grade
WNGA432WZ-LS3	WNGA080408WZ-LS3	0.098	0.500	0.187	0.031	0.203	TB650

For use in holders MWLNR/L, TWLNR/L, A-TWLNR/L, see pages 1063, 1102, 1141.

● = P ● = M ● = K ● = N ● = S ● = H

TOTURN™ CCGW LN7

POSITIVE 7 DEG CLEARANCE, 80 DEG RHOMBIC PCD-TIPPED INSERTS

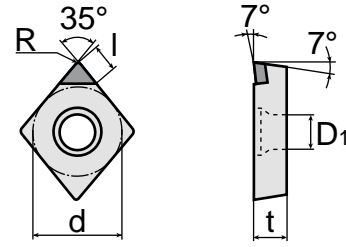
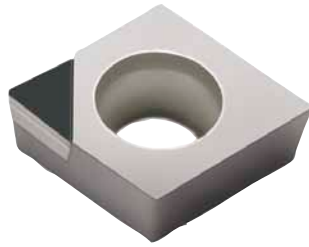

ANSI Number	ISO Number	l	d	t	R	Grade	KP300
CCGW21.50.5LN-7	CCGW060202LN-7	0.122	0.250	0.094	0.008	●	
CCGW21.51LN-7	CCGW060204LN-7	0.122	0.250	0.094	0.016	●	
CCGW21.52LN-7	CCGW060208LN-7	0.118	0.250	0.094	0.031	●	
CCGW32.51LN-7	CCGW09T304LN-7	0.157	0.375	0.156	0.016	●	
CCGW32.52LN-7	CCGW09RT308LN-7	0.154	0.375	0.156	0.031	●	
CCGW431LN-7	CCGW120404LN-7	0.157	0.500	0.187	0.016	●	
CCGW432LN-7	CCGW120408LN-7	0.154	0.500	0.187	0.031	●	

For use in holders SCACR-SH, SCLCR/L, SCLCR-SH, E-SCLCR/L (CARBIDE), S-SCLCR/L, see pages 1064-1066, 1125, 1126.

● = P ● = M ● = K ● = N ● = S ○ = H

TOTURN™ CNMA LN-10

80 DEGREE RHOMBIC PCD-TIPPED INSERTS

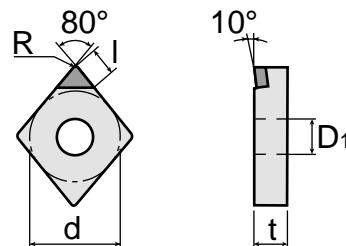

ANSI Number	ISO Number	l	d	t	R	D1	Grade	KP300
CNMA431LN-10	CNMA120404LN-10	0.157	0.500	0.187	0.016	0.203	●	
CNMA432LN-10	CNMA120408LN-10	0.154	0.500	0.187	0.031	0.203	●	
CNMA433LN-10	CNMA120412LN-10	0.150	0.500	0.187	0.047	0.203	●	

For use in holders MCLNR/L, TCKNR/L, TCLNR/L, TCMNN, TCRNR/L, S-MCLNR/L, A-TCLNR/L, see pages 1049, 1084, 1086, 1088, 1089, 1116, 1137.

● = P ● = M ● = K ● = N ● = S ○ = H

POSITIVE 7 DEGREE CLEARANCE, 55 DEGREE RHOMBIC PCD-TIPPED INSERTS

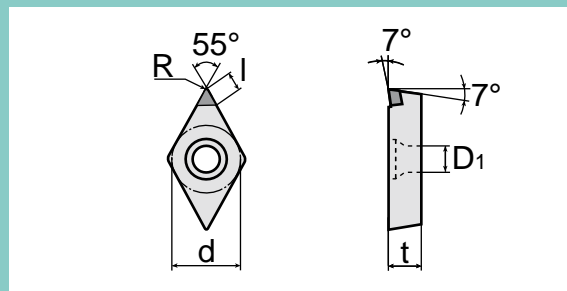
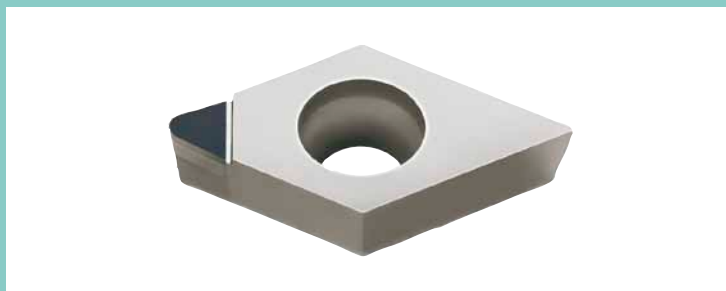

ANSI Number	ISO Number	l	d	t	R	D1	Grade	KP300
DCGW21.50.5LN-7	DCGW070202LN-7	0.134	0.250	0.094	0.008	0.110	●	
DCGW21.51LN-7	DCGW070204LN-7	0.130	0.250	0.094	0.016	0.110	●	
DCGW32.50.5LN-7	DCGW11T302LN-7	0.154	0.375	0.156	0.008	0.173	●	
DCGW32.51LN-7	DCGW11T304LN-7	0.146	0.375	0.156	0.016	0.173	●	
DCGW32.52LN-7	DCGW11T308LN-7	0.130	0.375	0.156	0.031	0.173	●	

For use in holders SDJCR/L, SDJCR/L-SH, SDNCN-SH, SDPCN, E-SDUCR (CARBIDE), S-SDUCR/L, see pages 1067, 1068, 1070, 1071, 1128.

● = P ● = M ● = K ● = N ● = S ○ = H

TOTURN™ DNMA LN-10

55 DEGREE RHOMBIC PCD TIPPED INSERTS

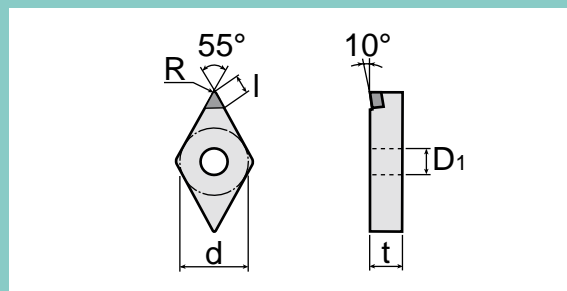

ANSI Number	ISO Number	l	d	t	R	D1	Grade	KP300
DNMA431LN-10	DNMA150404LN-10	0.157	0.500	0.187	0.016	0.203	●	
DNMA432LN-10	DNMA150408LN-10	0.146	0.500	0.187	0.031	0.203	●	
DNMA441LN-10	DNMA150604LN-10	0.157	0.500	0.250	0.016	0.203	●	
DNMA442LN-10	DNMA150608LN-10	0.146	0.500	0.250	0.031	0.203	●	

For use in holders MDJNR/L, MDQNR/L, TDJNR/L, TDNNN, TDQNR/L, A-TDUNR/L, see pages 1050, 1051, 1090, 1091, 1138.

● = P ● = M ● = K ● = N ● = S ○ = H

TOTURN™ SNMA LN-10

SQUARE, PCD TIPPED INSERTS

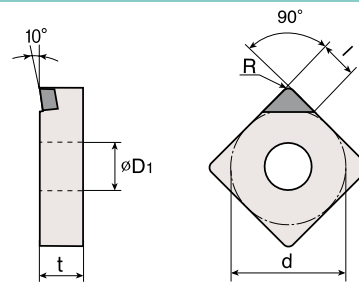
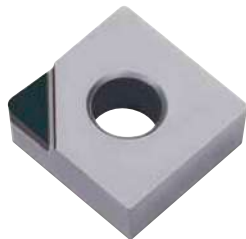

ANSI Number	ISO Number	l	d	t	R	D1	Grade	KP300
SNMA432LN-10	SNMA120408LN-10	0.157	0.500	0.187	0.031	0.203	●	
SNMA433LN-10	SNMA120412LN-10	0.157	0.500	0.187	0.047	0.203		

For use in holders MSDNN, MSRNR/L, MSSNR/L, TSDNN, TSKNR/L, TSRNR/L, TSSNR/L, S-MSKNR/L, see pages 1053 - 1055, 1094 - 1097, 1118.

● = P ● = M ● = K ● = N ● = S ○ = H

TOTURN™ TCGW LN-7

POSITIVE 7 DEGREE CLEARANCE, TRIANGULAR PCD TIPPED INSERTS

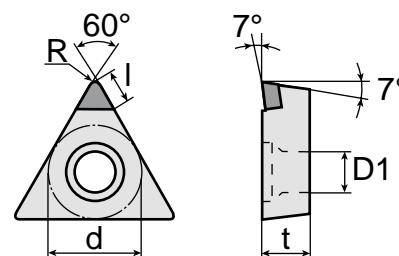
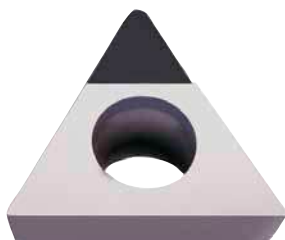

ANSI Number	ISO Number	l	d	t	R	D1	Grade	KP300
TCGW21.51LN-7	TCGW110204LN-7	0.150	0.250	0.094	0.016	0.110	●	
TCGW21.52LN-7	TCGW110208LN-7	0.138	0.250	0.094	0.031	0.110	●	
TCGW32.51LN-7	TCGW16T304LN-7	0.150	0.375	0.156	0.016	0.173	●	
TCGW32.52LN-7	TCGW16T308LN-7	0.138	0.375	0.156	0.031	0.173	●	
TCGW731LN-7	TCGW090204LN-7	0.130	0.219	0.094	0.016	0.098	●	
TCGW732LN-7	TCGW090208LN-7	0.118	0.219	0.094	0.031	0.098	●	

For use in holders STFCR/L, STGCR/L, E-STFCR/L (CARBIDE), S-STFCR/L, S-STUCR/L, see pages 1131, 1075, 1130 - 1132.

● = P ● = M ● = K ● = N ● = S ○ = H

TOTURN™ TNMA LN-10

TRIANGULAR PCD TIPPED INSERTS

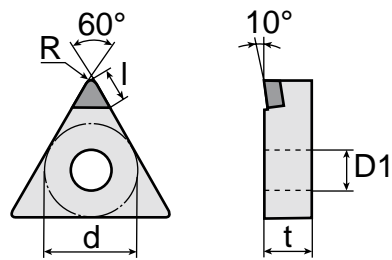

ANSI Number	ISO Number	l	d	t	R	D1	Grade	KP300
TNMA331LN-10	TNMA160404LN-10	0.169	0.375	0.187	0.016	0.150		●
TNMA332LN-10	TNMA160408LN-10	0.169	0.375	0.187	0.016	0.150		●

For use in holders MTCNN, MTENN, MTFNR/L, MTGNR/L, MTJNR/L, TTFNR/L, TTJNR/L, S-MTFNR/L, S-MTUNR/L, A-TTFNR/L, see pages 1056 - 1060, 1098, 1099, 1119, 1120, 1140.

● = P ● = M ● = K ● = N ● = S ○ = H

TOTURN™ TPGN LN-7

TRIANGULAR PCD TIPPED INSERTS

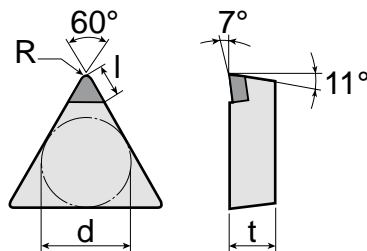

ANSI Number	ISO Number	l	d	t	R	D1	Grade	KP300
TPG220.5LN-7	TPGN110308LN-7	0.091	0.250	0.125	0.031	-		●
TPG221LN-7	TPGN110304LN-7	0.150	0.250	0.125	0.016	-		●
TPG222LN-7	TPGN110308LN-7	0.138	0.250	0.125	0.031	-		●
TPG320.5LN-7	TPGN160302LN-7	0.173	0.375	0.125	0.008	-		●
TPG321LN-7	TPGN160304LN-7	0.169	0.375	0.125	0.016	-		●
TPG322LN-7	TPGN160308LN-7	0.157	0.375	0.125	0.031	-		●

For use in holders CTAPR/L, CTCON, CTFPR/L, CTGPR/L, S-CTFPR/L, see pages 1021 - 1047, 1048, 1115.

● = P ● = M ● = K ● = N ● = S ○ = H

TOTURN™ VBGW LN-7

POSITIVE 5 DEGREE CLEARANCE, 35 DEGREE RHOMBIC PCD TIPPED INSERTS

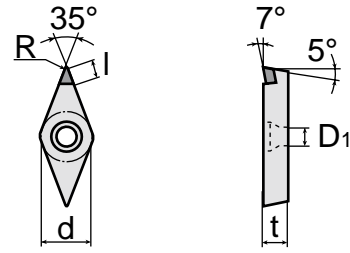

ANSI Number	ISO Number	l	d	t	R	D1	Grade	KP300
VBGW330.5LN-7	VBGW160402LN-7	0.205	0.375	0.187	0.008	0.173	●	
VBGW331LN-7	VBGW160404LN-7	0.197	0.375	0.187	0.016	0.173	●	
VBGW332LN-7	VBGW160408LN-7	0.165	0.375	0.187	0.031	0.173	●	

For use in holders SVJBR/L, S-SVQBR/L, see [pages 1078, 1134](#).

● = P ● = M ● = K ● = N ● = S ○ = H

TOTURN™ VCGW LN-7

POSITIVE 7 DEGREE CLEARANCE, 35 DEGREE RHOMBIC PCD TIPPED INSERTS

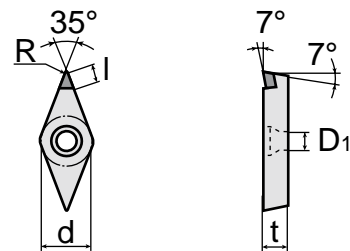

ANSI Number	ISO Number	l	d	t	R	D1	Grade	KP300
VCGW331LN-7	VCGW160404LN-7	0.197	0.375	0.187	0.016	0.173	●	

For use in holders SVJCR/L, S-SVQCR/L, S-SVUCR/L, see [pages 1080, 1134, 1135](#).

● = P ● = M ● = K ● = N ● = S ○ = H

35 DEGREE RHOMBIC PCD TIPPED INSERTS

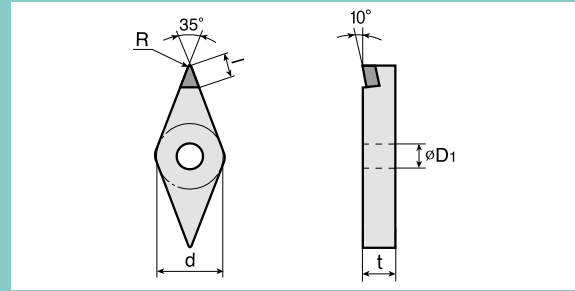

ANSI Number	ISO Number	l	d	t	R	D1	Grade	KP300
VNGA331LN-10	VNGA160404LN-10	0.197	0.375	0.187	0.016	0.150	●	
VNGA332LN-10	VNGA160408LN-10	0.161	0.375	0.187	0.031	0.150	●	

For use in holders TVJNR/L, TVQNR/L, TVVNN, S-MVUNR/L, S-MVXNR/L, see pages 1100, 1101, 1121, 1122.

● = P ● = M ● = K ● = N ● = S ○ = H

GENERAL TECHNICAL INFORMATION

TOOL HOLDER DESIGNATION SYSTEM (ANSI)

1 CLAMPING SYSTEM	
P / LEVER LOCK	C / TOP CLAMP
S / SCREW CLAMP	M / MULTI LOCK
T,D / DOUBLE CLAMP	W / WEDGE CLAMP

4 INSERT CLEARANCE ANGLE	
0°	5°
N	B
7°	11°
C	P

2 INSERT SHAPE		
80°	55°	75°
C	D	E
120°	55°	
H	K	R
		35°
S	T	V
		80°
		W



3 APPROACH ANGLE								
SYMBOL	SHAPE	OFFSET	SYMBOL	SHAPE	OFFSET	SYMBOL	SHAPE	OFFSET
A		x	J		0	V		x
			K		0	W		0
B		x	L		0	X	SPECIAL	
			M		x	C*		x
D		x	N		x	H*		0
E		x	R		0	Q*		0
F		0	S		0			
G		0	T		0			
			U		0			

Note: 0 = I.S.O. x = Ingersoll standard

5 HAND OF TOOL
Right Hand
R
Neutral
N
Left Hand
L

6 Shank Height

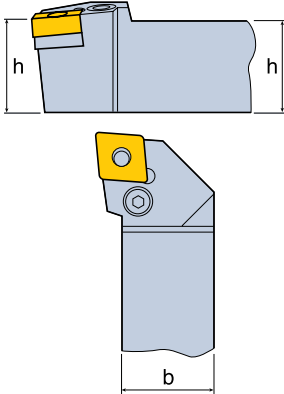

Digits	Size (inch)	
	h	b
05	.312	.312
06	.375	.375
08	.500	.500
10	.625	.625
12	.750	.750
16	1.00	1.00
20	1.25	1.25
24	1.50	1.50
32	2.00	2.00
44	.500	1.000
66	.750	1.500
85	1.00	1.25
86	1.00	1.50

7 Insert I.C.

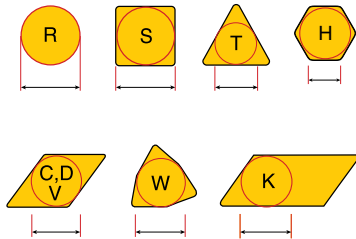

16 - 4 D -

6 7 8 9

8 Tool Length (inch)

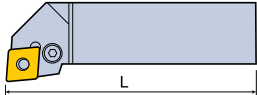

Symbol	L
K	2.5
J	3.5
A	4.0
B	4.5
C	5.0
D	6.0
E	7.0
F	8.0

9 Manufacturer's Type Designation

Unique to manufacturer

GENERAL TECHNICAL INFORMATION

TOTURN™ TOOL HOLDER DESIGNATION SYSTEM (ISO)

1 CLAMPING SYSTEM	
P / LEVER LOCK	C / TOP CLAMP
S / SCREW CLAMP	M / MULTI LOCK
T,D / DOUBLE CLAMP	W / WEDGE CLAMP

4 INSERT CLEARANCE ANGLE	
0°	5°
N	B
7°	11°
C	P

2 INSERT SHAPE		
80°	55°	75°
C	D	E
120°	55°	
H	K	R
		35°
S	T	V
		80°
		W

P	C	L	N	R
1	2	3	4	5

3 APPROACH ANGLE								
SYMBOL	SHAPE	OFFSET	SYMBOL	SHAPE	OFFSET	SYMBOL	SHAPE	OFFSET
A		x	J		0	V		x
			K		0	W		0
B		x	L		0	X	SPECIAL	
			M		x	C*		x
D		x	N		x	H*		0
E		x	R		0	Q*		0
F		0	S		0			
G		0	T		0			
			U		0			

Note: 0 = I.S.O. x = Ingersoll standard

5 HAND OF TOOL
Right Hand
R
Neutral
N
Left Hand
L

GENERAL TECHNICAL INFORMATION

TOTURN™ TOOL HOLDER DESIGNATION SYSTEM

6 SHANK HEIGHT

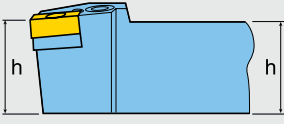

Integers to be preceded by 0
e.g.: h=8mm indicated by 08

7 SHANK WIDTH

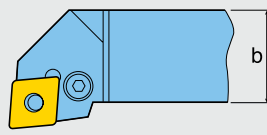

Integers to be preceded by 0
e.g.: b=8mm indicated by 08

9 CUTTING EDGE LENGTH

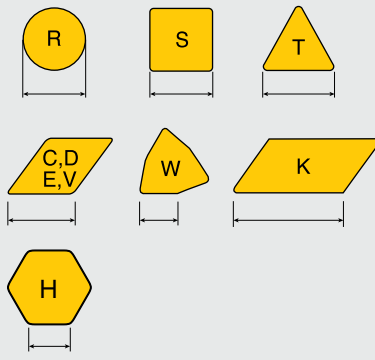

25 **25** **M** **12** - **10** **11**

6 **7** **8** **9** **10** **11**

8 TOOL LENGTH

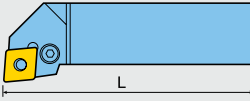

L (MM)	SYMBOL	L (MM)	SYMBOL
32	A	160	N
40	B	170	P
50	C	180	Q
60	D	200	R
70	E	250	S
80	F	300	T
90	G	350	U
100	H	400	V
110	J	450	W
125	K	500	Y
140	L	SPECIAL	X
150	M		

10 QUALIFIED TOOL

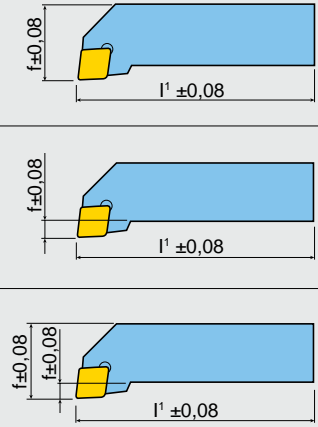

Q $f \pm 0,08$ $l' \pm 0,08$

F $f \pm 0,08$ $l' \pm 0,08$

B $f \pm 0,08$ $f \pm 0,08$ $l' \pm 0,08$

11 MANUFACTURER'S TYPE DESIGNATION

Unique to Manufacturer





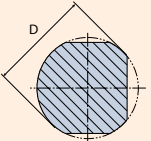
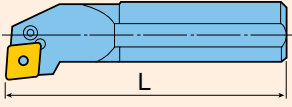
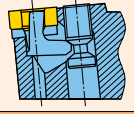
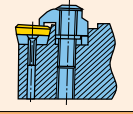
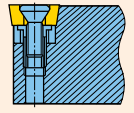
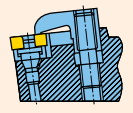
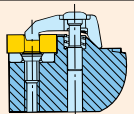
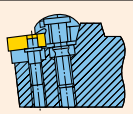

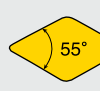

GENERAL TECHNICAL INFORMATION

BORING BAR DESIGNATION SYSTEM (ANSI-INCH SHANKS)

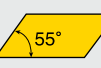



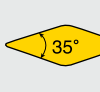

<p>1 Boring Bar</p> <p>S : Steel Shank</p> <p>A : Coolant Through Steel Shank</p> <p>C : Carbide Shank</p> <p>E : Coolant Through Carbide Shank</p> <p>X : Special</p>	<p>2 Bar Diameter</p>  <table border="1"> <thead> <tr> <th>Digits</th> <th>Size (inch)</th> </tr> </thead> <tbody> <tr><td>06</td><td>.375</td></tr> <tr><td>08</td><td>.500</td></tr> <tr><td>10</td><td>.625</td></tr> <tr><td>12</td><td>.750</td></tr> <tr><td>16</td><td>1.00</td></tr> <tr><td>20</td><td>1.25</td></tr> <tr><td>24</td><td>1.50</td></tr> <tr><td>28</td><td>1.75</td></tr> <tr><td>32</td><td>2.00</td></tr> <tr><td>36</td><td>2.25</td></tr> <tr><td>40</td><td>2.50</td></tr> </tbody> </table>	Digits	Size (inch)	06	.375	08	.500	10	.625	12	.750	16	1.00	20	1.25	24	1.50	28	1.75	32	2.00	36	2.25	40	2.50	<p>3 Tool Length (inch)</p>  <table border="1"> <tbody> <tr><td>H</td><td>4.0</td><td>S</td><td>10.0</td></tr> <tr><td>J</td><td>4.5</td><td>T</td><td>12.0</td></tr> <tr><td>K</td><td>5.0</td><td>U</td><td>14.0</td></tr> <tr><td>M</td><td>6.0</td><td>V</td><td>16.0</td></tr> <tr><td>Q</td><td>7.0</td><td>W</td><td>18.0</td></tr> <tr><td>R</td><td>8.0</td><td>Y</td><td>20.0</td></tr> </tbody> </table>	H	4.0	S	10.0	J	4.5	T	12.0	K	5.0	U	14.0	M	6.0	V	16.0	Q	7.0	W	18.0	R	8.0	Y	20.0	<p>4 Clamping System</p>   <p>P / Lever Lock C / Top Clamp</p>   <p>S / Screw Clamp M / Multi Lock</p>   <p>T / T-Clamp W / Wedge Clamp</p>
Digits	Size (inch)																																																		
06	.375																																																		
08	.500																																																		
10	.625																																																		
12	.750																																																		
16	1.00																																																		
20	1.25																																																		
24	1.50																																																		
28	1.75																																																		
32	2.00																																																		
36	2.25																																																		
40	2.50																																																		
H	4.0	S	10.0																																																
J	4.5	T	12.0																																																
K	5.0	U	14.0																																																
M	6.0	V	16.0																																																
Q	7.0	W	18.0																																																
R	8.0	Y	20.0																																																

S	20	U	-	T	W	L	N	R	-	4	-	
1	2	3		4	5	6	7	8	9	10		

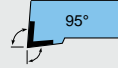

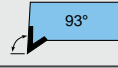
5 INSERT SHAPE

		
C	D	H
		
K	R	S
		
T	V	W

6 APPROACH ANGLE

	
L	K
	
U	Z
	
F	Q
	
P	

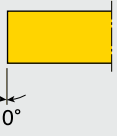
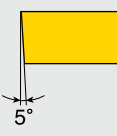



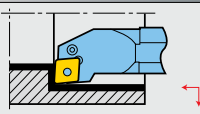
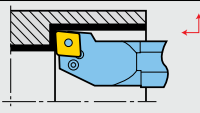

7 INSERT CLEARANCE ANGLE

	
N	B
	
C	P

8 HAND OF TOOL

R	 <p>Right Hand *Left Handed Insert Used</p>
L	 <p>Left Hand *Right Handed Insert Used</p>

9 INSERT I.C.

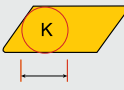
10 MANUFACTURER'S TYPE DESIGNATION

Unique to Manufacturer



GENERAL TECHNICAL INFORMATION

TOTURN™ BORING BAR DESIGNATION SYSTEM (ISO METRIC SHANKS)

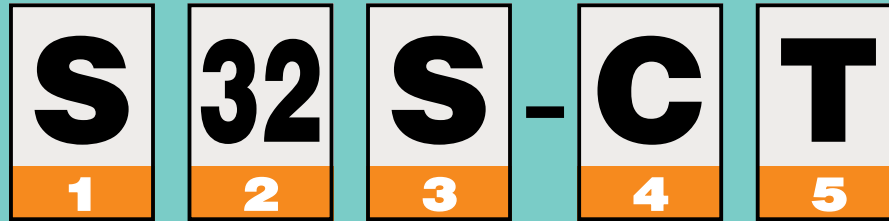

1 BORING BAR

- S:** Steel Shank
- A:** Coolant Through Steel Shank
- C:** Carbide Shank
- E:** Coolant Through Carbide Shank
- X:** Special

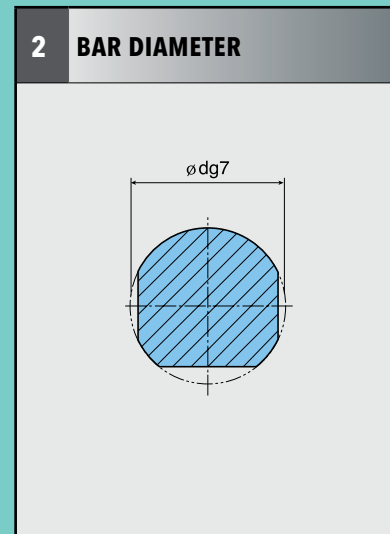

3 TOOL LENGTH

K	125	U	350
M	150	V	400
Q	180	W	450
R	200	Y	500
S	250	X	Sonder
T	300		

4 CLAMPING SYSTEM

P / LEVER LOCK	C / TOP CLAMP
S / SCREW CLAMP	M / MULTI LOCK
D / DOUBLE CLAMP	W / WEDGE CLAMP

5 INSERT SHAPE

C	D	E
H	K	R
S	T	V
W		

GENERAL TECHNICAL INFORMATION

T^oTURN™ BORING BAR DESIGNATION SYSTEM (ISO METRIC SHANKS)



6 APPROACH ANGLE	
95°	75°
L	K
93°	93°
U	Z
90°	45°
F	Q
117.5°	
P	













7 INSERT CLEARANCE ANGLE	
0°	5°
N	B
7°	11°
C	P













8 HAND OF TOOL	
R	<p>Right Hand *Left Handed Insert Used</p>
L	<p>Left Hand *Right Handed Insert Used</p>

9 CUTTING EDGE LENGTH		
R	S	T
C, D, E, V	W	K
H		













10 MANUFACTURER'S TYPE DESIGNATION	
Unique to Manufacturer	













TURNING HOLDER

External	Product	Description	Page
	TOTURN CKJNR/L	External top clamp tool holder for 55° KNUX__ inserts	1042
	TOTURN CKNNR	External top clamp tool holder for 55° KNUX__ inserts	1043
	TOTURN CSDPN	External top clamp tool holder for positive 80° SP_ inserts	1044
	TOTURN CTAPR/L	External top clamp tool holder for positive 60° TP_ inserts	1045
	TOTURN CTCON	External top clamp tool holder for positive 60° TP_ inserts	1046
	TOTURN CTFPR/L	External top clamp tool holder for positive 60° TP_ inserts	1047
	TOTURN CTGPR/L	External top clamp tool holder for positive 60° TP_ inserts	1048
	TOTURN MCLNR/L	External tool holder with multi lock clamp for 80° CN__ inserts	1049
	TOTURN MDJNR/L	External tool holder with multi lock clamp for 55° DN__ inserts	1050
	TOTURN MDQNR/L	External tool holder with multi lock clamp for 55° DN__ inserts	1051
	TOTURN MRGNR/L	External tool holder with multi lock clamp for RN__ round inserts	1052
	TOTURN MSDNN	External tool holder with multi lock clamp for SN__ inserts	1053











External	Product	Description	Page
	TOTURN MSRNR/L	External tool holder with multi lock clamp for SN__ inserts	1054
	TOTURN MSSNR/L	External tool holder with multi lock clamp for SN__ inserts	1055
	TOTURN MTCNN	External tool holder with multi lock clamp for 60° TN_ inserts	1056
	TOTURN MTENN	External tool holder with multi lock clamp for 60° TN_ inserts	1057
	TOTURN MTFNR/L	External tool holder with multi lock clamp for 60° TN_ inserts	1058
	TOTURN MTGNR/L	External tool holder with multi lock clamp for 60° TN_ inserts	1059
	TOTURN MTJNR/L	External tool holder with multi lock clamp for 60° TN_ inserts	1060
	TOTURN MVJNR/L	External tool holder with multi lock clamp for 35° VN__ inserts	1062
	TOTURN MWLNR/L	External tool holder with multi lock clamp for trigon WN__ inserts	1063
	TOTURN SCACR-SH	External tool holder with screw clamping and short head for positive 80° CC__ inserts	1064
	TOTURN SCLCR/L	External tool holder with screw clamping and for positive 80° CC__ inserts	1065
	TOTURN SCLCR-SH	External tool holder with screw clamping and short head for positive 80° CC__ inserts	1066









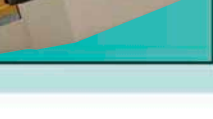



TURNING HOLDER

External	Product	Description	Page
	TOTURN SDJCR/L	External tool holder with screw clamping for positive 55° DC__ inserts	1067
	TOTURN SDJCR/L-SH	External tool holder with screw clamping and short head for positive 55° DC__ inserts	1068
	TOTURN SDJNR/L	External tool holder with screw clamping and for negative 55° DN__ inserts	1069
	TOTURN SDNCN-SH	External tool holder with screw clamping and short head for positive 55° DC__ inserts	1070
	TOTURN SDPCN	External tool holder with screw clamping for positive 55° DC__ inserts	1071
	TOTURN SRDCN	External tool holder with screw clamping for positive round inserts	1072
	TOTURN SRGCR/L	External tool holder with screw clamping for positive round inserts	1073
	TOTURN SSDCN	External tool holder with screw clamping for positive 90° SC__ inserts	1074
	TOTURN STFCR/L	External tool holder with screw clamping for positive 60° TC__ inserts	1075
	TOTURN STGCR/L	External tool holder with screw clamping for positive 60° TC__ inserts	1076
	TOTURN STGCR-SH	External tool holder with screw clamping and short head for positive 60° TC__ inserts	1077
	TOTURN SVJBR/L	External tool holder with screw clamping for positive 35° VB__ inserts	1078













External	Product	Description	Page
	TOTURN SVJBR/L-SH	External tool holder with screw clamping and short head for positive 35° VB__ inserts	1079
	TOTURN SVJCR/L	External tool holder with screw clamping for positive 35° VC__ inserts	1080
	TOTURN SVJNR/L	External tool holder with screw clamping for negative 35° VN__ inserts	1081
	TOTURN SVVBN	External tool holder with screw clamping for positive 35° VB__ inserts	1082
	TOTURN SVVBN-SH	External tool holder with screw clamping and short head for positive 35° VB__ inserts	1082
	TOTURN SVVCN	External tool holder with screw clamping for positive 35° VC__ inserts	1083
	TOTURN TCKNR/L	External tool holder with T-type clamping system for 80° CN__ inserts	1084
	TOTURN TCLNR/L	External tool holder with T-type clamping system for 80° CN__ inserts	1086
	TOTURN TCMNN	External tool holder with T-type clamping system for 80° CN__ inserts	1088
	TOTURN TCRNR/L	External tool holder with T-type clamping system for 80° CN__ inserts	1089
	TOTURN TDJNR/L	External tool holder with T-type clamping system for 55° DN__ inserts	1090
	TOTURN TDNNN	External tool holder with T-type clamping system for 55° DN__ inserts	1091













TURNING HOLDER

External	Product	Description	Page
	TOTURN TDQNR/L	External tool holder with T-type clamping system for 55° DN__ inserts	1091
	TOTURN THSNR/L	External tool holder with T-type clamping system for 120° HN__ inserts	1092
	TOTURN THSN QUICK CHANGE	External tool holder with T-type clamping system for 120° HN__ inserts	1093
	TOTURN TSDNN	External tool holder with T-type clamping system for 90° SN__ inserts	1094
	TOTURN TSKNR/L	External tool holder with T-type clamping system for 90° SN__ inserts	1095
	TOTURN TSRNR/L	External tool holder with T-type clamping system for 90° SN__ inserts	1096
	TOTURN TSSNR/L	External tool holder with T-type clamping system for 90° SN__ inserts	1097
	TOTURN TTFNR/L	External tool holder with T-type clamping system for 60° TN__ inserts	1098
	TOTURN TTJNR/L	External tool holder with T-type clamping system for 60° TN__ inserts	1099
	TOTURN TVJNR/L	External tool holder with T-type clamping system for 35° VN__ inserts	1100
	TOTURN TVQNR/L	External tool holder with T-type clamping system for 35° VN__ inserts	1101
	TOTURN TVVNN	External tool holder with T-type clamping system for 35° VN__ inserts	1101









External	Product	Description	Page
	TOTURN TWTNR/L	External tool holder with T-type clamping system for Trigon WN__ inserts	1102
	TOTURN CCLNR/L	External tool holder with wedge type clamping system for 80° TN__ inserts	1103
	TOTURN CRDNN	External tool holder with T-type clamping system for ceramic inserts	1104
	TOTURN CRGNR/L	External tool holder with T-type clamping system for ceramic inserts	1105
	TOTURN CSDNN	External tool holder with T-type clamping system for ceramic inserts	1106
	TOTURN CSKNR/L	External tool holder with T-type clamping system for ceramic inserts	1107
	TOTURN CSRNR	External tool holder with T-type clamping system for ceramic inserts	1108
	TOTURN CSSNR	External tool holder with T-type clamping system for ceramic inserts	1109
	TOTURN CTJNR	External tool holder with T-type clamping system for ceramic inserts	1110
	TOTURN TCLNR/L-CH	External tool holder with T-type clamping system for dimple ceramic inserts	1111
	TOTURN TDJNR/L-CH	External tool holder with T-type clamping system for dimple ceramic inserts	1112
	TOTURN TSSNR/L-CH	External tool holder with T-type clamping system for dimple ceramic inserts	1113

TURNING HOLDER

Internal	Product	Description	Page
	TOTURN S-CKUNR/L	Internal top clamp tool holder for 55° KNUX__ inserts	1114
	TOTURN S-CTFPR/L	Internal top clamp tool holder for positive 60° TP__ inserts	1115
	TOTURN S-MCLNR/L	Internal top clamp tool holder for 80° CN__ inserts	1116
	TOTURN S-MSKNR/L	Internal top clamp tool holder for SN__ inserts	1118
	TOTURN S-MTFNR/L	Internal tool holder with multi lock clamp for 60° TN__ inserts	1119
	TOTURN S-MTUNR/L	Internal tool holder with multi lock clamp for 60° TN__ inserts	1120
	TOTURN S-MVUNR/L	Internal tool holder with multi lock clamp for 35° VN__ inserts	1121
	TOTURN S-MVXNR/L	Internal tool holder with multi lock clamp for 35° VN__ inserts	1122
	TOTURN S-PCLNR/L	Internal tool holder with lever lock clamp for 80° CN__ inserts	1123
	TOTURN S-PTFNR/L	Internal tool holder with lever lock clamp for 60° TN__ inserts	1124
	TOTURN E-SCLCR/L (CARBIDE)	Internal carbide shank tool holder with screw clamp for 80° CC__ inserts	1125
	TOTURN S-SCLCR/L	Internal tool holder with screw clamping for positive 80° CC__ inserts	1126

Internal	Product	Description	Page
	TOTURN S-SCFPR/L	Internal tool holder with screw clamping for positive 80° CP__ inserts	1127
	TOTURN S-SCLPR/L	Internal tool holder with screw clamping for positive 80° CP__ inserts	1127
	TOTURN E-SDUCR (CARBIDE)	Internal carbide shank tool holder with screw clamp for positive 55° DC__ inserts	1128
	TOTURN S-SDUCR/L	Internal tool holder with screw clamping for positive 55° DC__ inserts	1128
	TOTURN A-SDQNR/L	Internal tool holder with screw clamping for negative 55° DN__ inserts with internal coolant	1129
	TOTURN A-SDUNR/L	Internal tool holder with screw clamping for negative 60° TC__ inserts with internal coolant	1129
	TOTURN E-STFCR/L (CARBIDE)	Internal carbide shank tool holder with screw clamp for positive 55° DC__ inserts	1130
	TOTURN S-STFCR/L	Internal tool holder with screw clamping for positive 60° TC__ inserts	1131
	TOTURN S-STUCR/L	Internal tool holder with screw clamping for positive 60° TC__ inserts	1132
	TOTURN S-STFPR/L	Internal tool holder with screw clamping for positive 60° TP__ inserts	1132
	TOTURN A-SVUNR/L	Internal tool holder with screw clamping for 35° VN__ inserts	1133
	TOTURN S-SVQBR/L	Internal tool holder with screw clamping for positive 35° VB__ inserts	1134

TURNING HOLDER

Internal	Part	Description	Page
	TOTURN S-SVQCR/L	Internal tool holder with screw clamping for positive 60° VC__ inserts	1134
	TOTURN S-SVUCR/L	Internal tool holder with screw clamping for positive 60° VC__ inserts	1135
	TOTURN S-SVXCR/L	Internal tool holder with screw clamping for positive 60° VC__ inserts	1136
	TOTURN A-TCLNR/L	External tool holder with T-type clamping system for 80° CN__ inserts with internal coolant	1137
	TOTURN A-TDUNR/L	External tool holder with T-type clamping system for 55° DN__ inserts with internal coolant	1138
	TOTURN A-THSNR/L	External tool holder with T-type clamping system for 120° HN__ inserts with internal coolant	1139
	TOTURN A-TTFNR/L	External tool holder with T-type clamping system for 60° TN__ inserts with internal coolant	1140
	TOTURN A-TWLNRL/L	External tool holder with T-type clamping system for trigon inserts with internal coolant	1141
	TOTURN S-TCLNR/L-CH	External tool holder with T-type clamping system for 80° ceramic inserts	1142

EXTERNAL TOP CLAMP TOOL HOLDER FOR 55° KNUX__ INSERTS

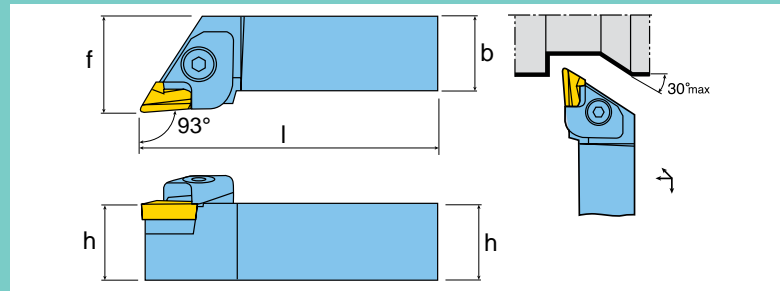

Designation	h	b	l	f
CKJNL16-3D	1.000	1.000	6.000	1.250
CKJNR16-3D	1.000	1.000	6.000	1.250
CKJNL20-3E	1.250	1.250	7.000	1.500
CKJNR20-3E	1.250	1.250	7.000	1.500
CKJNR85-3E	1.250	1.000	7.000	1.250

For inserts, see [pages 920 & 921](#).

HARDWARE										
	Accepts Insert Series	Seat	Seat Screw	Clamp	Clamp Screw	Clamp Spring	Pin	Pin and Spring	Seat Screw Wrench	Clamp Screw Wrench
CKJNL16-3D	KNUX333_L_	CSK1604L	FHM3X0.5X10	CL16KL	CLS16K	KSP90	KP48S	KSP48	L-W2	L-W4
CKJNR16-3D	KNUX333_R_	CSK1604R	FHM3X0.5X10	CL16KR	CLS16K	KSP90	KP48S	KSP48	L-W2	L-W4
CKJNL20-3E	KNUX333_L_	CSK1604L	FHM3X0.5X10	CL16KL	CLS16K	KSP90	KP48S	KSP48	L-W2	L-W4
CKJNR20-3E	KNUX333_R_	CSK1604R	FHM3X0.5X10	CL16KR	CLS16K	KSP90	KP48S	KSP48	L-W2	L-W4
CKJNR85-3E	KNUX333_R_	CSK1604R	FHM3X0.5X10	CL16KR	CLS16K	KSP90	KP48S	KSP48	L-W2	L-W4

EXTERNAL TOP CLAMP TOOL HOLDER FOR 55° KNUX__ INSERTS

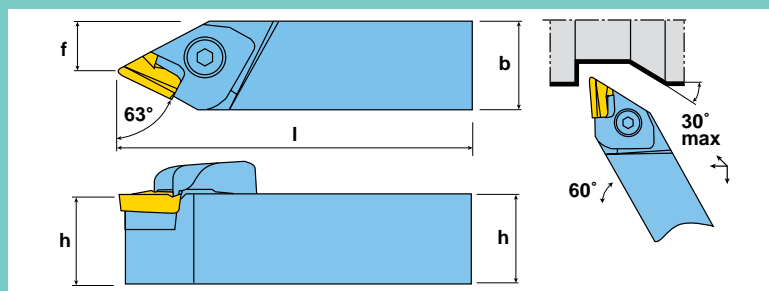

Designation	h	b	l	f
CKNNR16-3D	1.000	1.000	6.000	0.566

For inserts, see [pages 920 & 921](#).

HARDWARE										
	Accepts Insert Series	Seat	Seat Screw	Clamp	Clamp Screw	Clamp Spring	Pin	Pin and Spring	Seat Screw Wrench	Clamp Screw Wrench
CKNNR16-3D	KNUX333_R_	CSK1604R	FHM3X0.5X10	CL16KR	CLS16K	KSP90	KP48S	KSP48	L-W2	L-W4

EXTERNAL TOP CLAMP TOOL HOLDER FOR POSITIVE 80° SP_ INSERTS

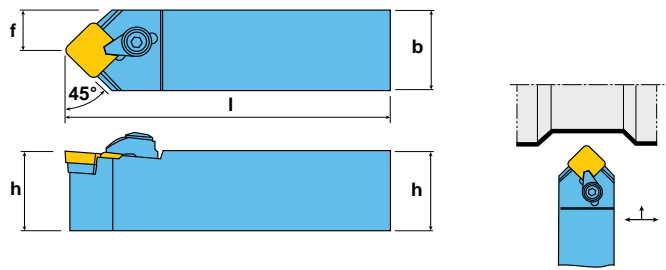

Designation	h	b	l	f
CSDPN10-3B	0.625	0.625	4.500	0.313
CSDPN12-3B	0.750	0.750	4.500	0.375
CSDPN12-4B	0.750	0.750	4.500	0.375
CSDPN16-4D	1.000	1.000	6.000	0.500
CSDPN16-6D	1.000	1.000	6.000	0.500

For inserts, see [pages 975 - 977, 1003](#).

HARDWARE								
	Accepts Insert Series	Seat	Seat Screw	Clamp	Clamp Screw	Clamp Clip	Seat Screw Wrench	Clamp Screw Wrench
CSDPN10-3B	SP_32_	-	-	HC9	CS96	CLP9	-	L-W4
CSDPN12-3B	SP_32_	-	-	HC9	CS96	CLP9	-	L-W4
CSDPN12-4B	SP_42_	SM-40	TS-44-2	HC12	CS126	CLP12	L-W2	L-W4
CSDPN16-4D	SP_42_	SM-40	TS-44-2	HC12	CS126	CLP12	L-W2	L-W4
CSDPN16-6D	SP_63_	SM-36	TS-10	HC12	CS126	CLP12	L-W2	L-W4

EXTERNAL TOP CLAMP TOOL HOLDER FOR POSITIVE 60° TP_ INSERTS

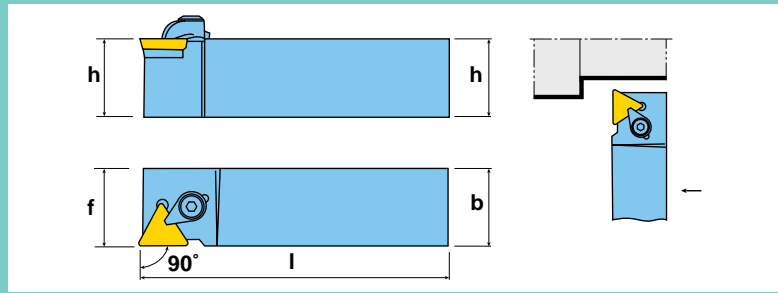

Designation	h	b	l	f
CTAPL06-2J	0.375	0.375	3.500	0.515
CTAPR06-2J	0.375	0.375	3.500	0.515
CTAPL08-2J	0.500	0.500	3.500	0.515
CTAPR08-2J	0.500	0.500	3.500	0.515
CTAPL10-2B	0.625	0.625	4.500	0.640
CTAPR10-2B	0.625	0.625	4.500	0.640
CTAPL12-3B	0.750	0.750	4.500	0.765
CTAPR12-3B	0.750	0.750	4.500	0.765
CTAPL16-3D	1.000	1.000	6.000	1.015
CTAPR16-3D	1.000	1.000	6.000	1.015
CTAPL16-4D	1.000	1.000	6.000	1.015
CTAPR16-4D	1.000	1.000	6.000	1.015

For inserts, see [pages 980, 983, 985, 1005, 1015, 1021](#).

HARDWARE								
	Accepts Insert Series	Seat	Seat Screw	Clamp	Clamp Screw	Clamp Clip	Seat Screw Wrench	Clamp Screw Wrench
CTAPL06-2J	TP_22_	-	-	HC9	CS96	CLP9	L-W2	L-W4
CTAPR06-2J	TP_22_	-	-	HC9	CS96	CLP9	L-W2	L-W4
CTAPL08-2J	TP_22_	-	-	HC9	CS96	CLP9	L-W2	L-W4
CTAPR08-2J	TP_22_	-	-	HC9	CS96	CLP9	L-W2	L-W4
CTAPL10-2B	TP_22_	-	-	HC9	CS96	CLP9	L-W2	L-W4
CTAPR10-2B	TP_22_	-	-	HC9	CS96	CLP9	L-W2	L-W4
CTAPL12-3B	TP_32_	SM-41	TS-4	HC12	CS126	CLP12	L-W2	L-W4
CTAPR12-3B	TP_32_	SM-41	TS-4	HC12	CS126	CLP12	L-W2	L-W4
CTAPL16-3D	TP_32_	SM-41	TS-4	HC12	CS126	CLP12	L-W2	L-W4
CTAPR16-3D	TP_32_	SM-41	TS-4	HC12	CS126	CLP12	L-W2	L-W4
CTAPL16-4D	TP_43_	SM-37	TS-6	HC12	CS126	CLP12	L-W2	L-W4
CTAPR16-4D	TP_43_	SM-37	TS-6	HC12	CS126	CLP12	L-W2	L-W4

EXTERNAL TOP CLAMP TOOL HOLDER FOR POSITIVE 60° TP_ INSERTS

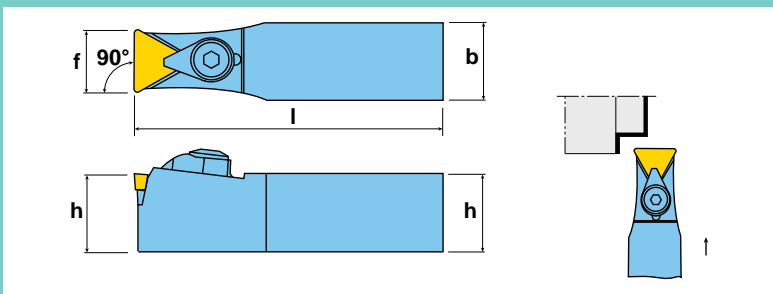

Designation	h	b	l	f
CTCON08-3J	0.500	0.500	3.500	-
CTCON44-3F	1.000	0.500	8.000	-
CTCON12-4B	0.750	0.750	4.500	-
CTCON64-4F	1.000	0.750	8.000	-
CTCON66-4F	1.500	0.750	8.000	-

For inserts, see [pages 980, 983, 985, 1005, 1015, 1021](#).

HARDWARE								
	Accepts Insert Series	Seat	Seat Screw	Clamp	Clamp Screw	ClampClip	Seat Screw Wrench	Clamp Screw Wrench
CTCON08-3J	TP_32_	-	-	HC9	CS96	CLP9	L-W2	L-W4
CTCON44-3F	TP_32_	SM-41	TS-4	HC9	CS96	CLP9	L-W2	L-W4
CTCON12-4B	TP_43_	SM-37	TS-10	HC12	CS126	CLP12	L-W2	L-W4
CTCON64-4F	TP_43_	SM-37	TS-10	HC12	CS126	CLP12	L-W2	L-W4
CTCON66-4F	TP_43_	SM-37	TS-10	HC12	CS126	CLP12	L-W2	L-W4

EXTERNAL TOP CLAMP TOOL HOLDER FOR POSITIVE 60° TP_ INSERTS

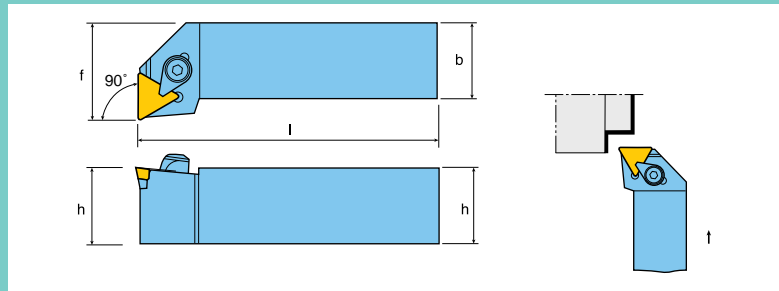

Designation	h	b	l	f
CTFPL10-3B	0.625	0.625	4.500	0.875
CTFPR10-3B	0.625	0.625	4.500	0.875
CTFPL12-3B	0.750	0.750	4.500	1.000
CTFPR12-3B	0.750	0.750	4.500	1.000
CTFPL16-3D	1.000	1.000	6.000	1.250
CTFPR16-3D	1.000	1.000	6.000	1.250
CTFPL12-4B	0.750	0.750	4.500	1.000
CTFPR12-4B	0.750	0.750	4.500	1.000
CTFPL16-4D	1.000	1.000	6.000	1.250
CTFPR16-4D	1.000	1.000	6.000	1.250
CTFPL20-4D	1.250	1.250	6.000	1.500
CTFPR20-4D	1.250	1.25 0	6.000	1.500

For inserts, see [pages 980, 983, 985, 1005, 1015, 1021](#).

HARDWARE								
	Accepts Insert Series	Seat	Seat Screw	Clamp	Clamp Screw	Clamp Clip	Seat Screw Wrench	Clamp Screw Wrench
CTFPL10-3B	TP_32_	SM-41	TS-4	HC12	CS126	CLP12	L-W2	L-W4
CTFPR10-3B	TP_32_	SM-41	TS-4	HC12	CS126	CLP12	L-W2	L-W4
CTFPL12-3B	TP_32_	SM-41	TS-4	HC12	CS126	CLP12	L-W2	L-W4
CTFPR12-3B	TP_32_	SM-41	TS-4	HC12	CS126	CLP12	L-W2	L-W4
CTFPL16-3D	TP_32_	SM-41	TS-4	HC12	CS126	CLP12	L-W2	L-W4
CTFPR16-3D	TP_32_	SM-41	TS-4	HC12	CS126	CLP12	L-W2	L-W4
CTFPL12-4B	TP_43_	SM-37	TS-10	HC12	CS126	CLP12	L-W2	L-W4
CTFPR12-4B	TP_43_	SM-37	TS-10	HC12	CS126	CLP12	L-W2	L-W4
CTFPL16-4D	TP_43_	SM-37	TS-10	HC12	CS126	CLP12	L-W2	L-W4
CTFPR16-4D	TP_43_	SM-37	TS-10	HC12	CS126	CLP12	L-W2	L-W4
CTFPL20-4D	TP_43_	SM-37	TS-10	HC12	CS126	CLP12	L-W2	L-W4
CTFPR20-4D	TP_43_	*SM-37	TS-10	HC12	CS126	CLP12	L-W2	L-W4

EXTERNAL TOP CLAMP TOOL HOLDER FOR POSITIVE 60° TP_ INSERTS

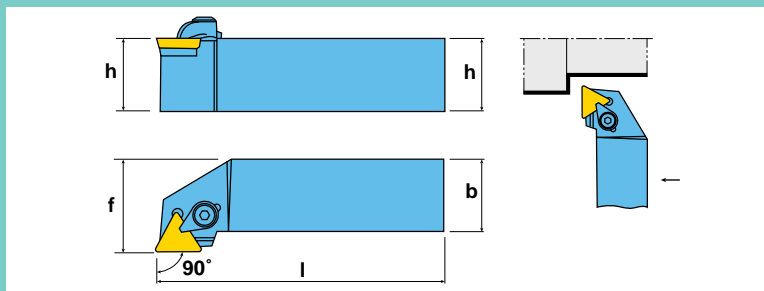

Designation	h	b	l	f
CTGPL10-3B	0.625	0.625	4.500	0.875
CTGPR10-3B	0.625	0.625	4.500	0.875
CTGPL12-3B	0.750	0.750	4.500	1.000
CTGPR12-3B	0.750	0.750	4.500	1.000
CTGPL16-4D	1.000	1.000	6.000	1.250
CTGPR16-4D	1.000	1.000	6.000	1.250
CTGPL20-4D	1.250	1.250	6.000	1.500
CTGPR20-4D	1.250	1.250	6.000	1.500

For inserts, see [pages 980, 983, 985, 1005, 1015, 1021](#).

HARDWARE								
	Accepts Insert Series	Seat	Seat Screw	Clamp	Clamp Screw	Clamp Clip	Seat Screw Wrench	Clamp Screw Wrench
CTGPL10-3B	TP_32_	SM-41	TS-4	HC12	CS126	CLP12	L-W2	L-W4
CTGPR10-3B	TP_32_	SM-41	TS-4	HC12	CS126	CLP12	L-W2	L-W4
CTGPL12-3B	TP_32_	SM-41	TS-4	HC12	CS126	CLP12	L-W2	L-W4
CTGPR12-3B	TP_32_	SM-41	TS-4	HC12	CS126	CLP12	L-W2	L-W4
CTGPL16-4D	TP_43_	SM-37	TS-10	HC12	CS126	CLP12	L-W2	L-W4
CTGPR16-4D	TP_43_	SM-37	TS-10	HC12	CS126	CLP12	L-W2	L-W4
CTGPL20-4D	TP_43_	SM-37	TS-10	HC12	CS126	CLP12	L-W2	L-W4
CTGPR20-4D	TP_43_	SM-37	TS-10	HC12	CS126	CLP12	L-W2	L-W4

EXTERNAL TOOL HOLDER WITH MULTI LOCK CLAMP FOR 80° CN__ INSERTS

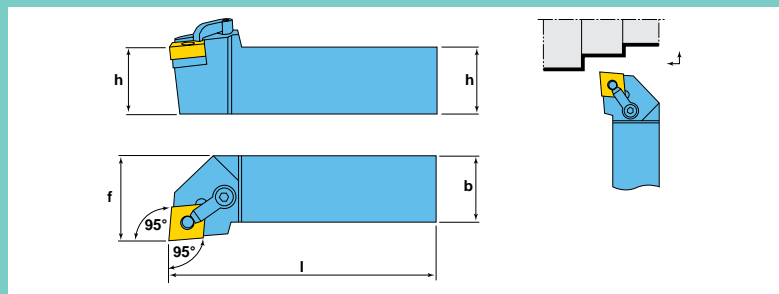

Designation	h	b	l	f
MCLNL08-3A	0.500	0.500	4.000	0.750
MCLNR08-3A	0.500	0.500	4.000	0.750
MCLNL10-3A	0.625	0.625	4.000	1.000
MCLNR10-3A	0.625	0.625	4.000	1.000
MCLNL10-4B	0.625	0.625	4.500	1.000
MCLNR10-4B	0.625	0.625	4.500	1.000
MCLNL85-4D	1.250	1.000	6.000	1.250
MCLNR85-4D	1.250	1.000	6.000	1.250
MCLNR86-5E	1.500	1.000	7.000	1.250
MCLNL85-6D	1.250	1.000	6.000	1.250
MCLNR85-6D	1.250	1.000	6.000	1.250

For inserts, see [pages 894 - 908, 993, 994, 996, 1009, 1018](#).

HARDWARE							
	Accepts Insert Series	Seat	Clamp	Clamp Screw	Lock Pin	Clamp Screw Wrench	Lock Pin Wrench
MCLNL08-3A	CN_32_	-	CL6	XNS37	NL33	AG00078LLA 5/64"	AG00078LLA 5/64"
MCLNR08-3A	CN_32_	-	CL6	XNS37	NL33	AG00078LLA 5/64"	AG00078LLA 5/64"
MCLNL10-3A	CN_32_	-	CL6	XNS37	NL33	AG00078LLA 5/64"	AG00078LLA 5/64"
MCLNR10-3A	CN_32_	-	CL6	XNS37	NL33	AG00078LLA 5/64"	AG00078LLA 5/64"
MCLNL10-4B	CN_43_	ICSN433	CL20	XNS48	NL46	AG00125LLA 1/8"	AG00093LLA 3/32"
MCLNR10-4B	CN_43_	ICSN433	CL20	XNS48	NL46	AG00125LLA 1/8"	AG00093LLA 3/32"
MCLNL85-4D	CN_43_	ICSN433	CL20	XNS48	NL46	AG00125LLA 1/8"	AG00093LLA 3/32"
MCLNR86-5E	CN_54_	ICSN533	CL12	XNS510	NL58	AG00125LLA 1/8"	-
MCLNR85-4D	CN_43_	ICSN433	CL20	XNS48	NL46	AG00125LLA 1/8"	AG00093LLA 3/32"
MCLNL85-6D	CN_64_	ICSN633	CL12	XNS510	NL68	5/32HEX	AG00140LLA 9/64"
MCLNR85-6D	CN_64_	ICSN633	CL12	XNS510	NL68	5/32HEX	AG00140LLA 9/64"

EXTERNAL TOOL HOLDER WITH MULTI LOCK CLAMP FOR 55° DN__ INSERTS

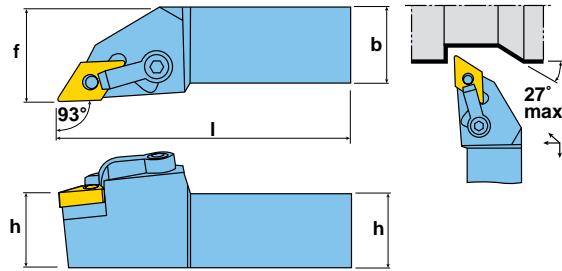

Designation	h	b	l	f
MDJNR08-3A	0.500	0.500	4.000	0.750
MDJNL10-3B	0.625	0.625	4.500	0.875
MDJNR10-3B	0.625	0.625	4.500	0.875
MDJNR85-4D	1.250	1.000	6.000	1.250
MDJNL24-4D	1.500	1.500	6.000	2.000
MDJNR24-4D	1.500	1.500	6.000	2.000

For inserts, see [pages 909 - 919, 997, 998, 1011, 1019](#).

HARDWARE							
	Accepts Insert Series	Seat	Clamp	Clamp Screw	Lock Pin	Clamp Screw Wrench	Lock Pin Wrench
MDJNR08-3A	DN_33_	-	CL7	XNS36	NL33	AG00093LLA 3/32"	AG00078LLA 5/64"
MDJNL10-3B	DN_33_	IDSN322	CL7	XNS36	NL33	AG00093LLA 3/32"	AG00078LLA 5/64"
MDJNR10-3B	DN_33_	IDSN322	CL7	XNS36	NL33	AG00093LLA 3/32"	AG00078LLA 5/64"
MDJNR85-4D	DN_43_	IDSN433	CL20	XNS48	NL46	AG00125LLA 1/8"	AG00093LLA 3/32"
MDJNL24-4D	DN_43_	IDSN433	CL20	XNS48	NL46	AG00125LLA 1/8"	AG00093LLA 3/32"
MDJNR24-4D	DN_43_	IDSN433	CL20	XNS48	NL46	AG00125LLA 1/8"	AG00093LLA 3/32"

EXTERNAL TOOL HOLDER WITH MULTI LOCK CLAMP FOR 55° DN__ INSERTS

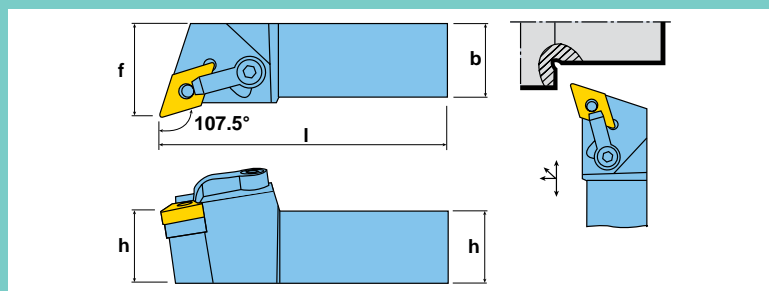

Designation	h	b	l	f
MDQNL12-4B	0.750	0.750	4.500	1.000
MDQNR12-4B	0.750	0.750	4.500	1.000
MDQNL20-4D	1.250	1.250	6.000	1.500
MDQNR20-4D	1.250	1.250	6.000	1.500

For inserts, see pages 909 - 919, 997, 998, 1011, 1019.





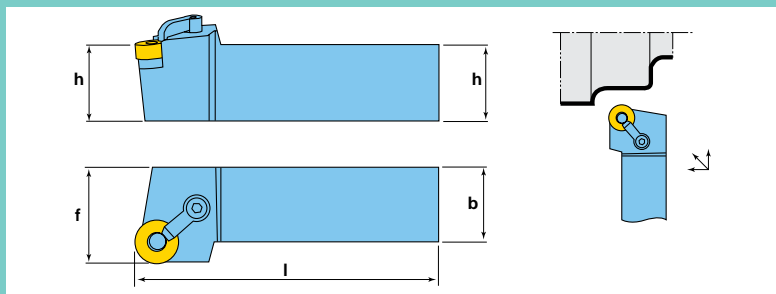

HARDWARE							
	Accepts Insert Series	Seat	Clamp	Clamp Screw	Lock Pin	Clamp Screw Wrench	Lock Pin Wrench
MDQNL12-4B	DN__43__	IDSN433	CL12	XNS510	NL46	5/32HEX	AG00093LLA 3/32"
MDQNR12-4B	DN__43__	IDSN433	CL12	XNS510	NL46	5/32HEX	AG00093LLA 3/32"
MDQNL20-4D	DN__43__	IDSN433	CL12	XNS510	NL46	5/32HEX	AG00093LLA 3/32"
MDQNR20-4D	DN__43__	IDSN433	CL12	XNS510	NL46	5/32HEX	AG00093LLA 3/32"

EXTERNAL TOOL HOLDER WITH MULTI LOCK CLAMP FOR RN__ ROUND INSERTS



Designation	h	b	l	f
MRGNL12-4B	0.750	0.750	4.500	1.000
MRGNL16-4D	1.000	1.000	6.000	1.250
MRGNL20-4D	1.250	1.250	6.000	1.500
MRGNR12-4B	0.750	0.750	4.500	1.000
MRGNR16-4D	1.000	1.000	6.000	1.250
MRGNR20-4D	1.250	1.250	6.000	1.500

For inserts, see [page 921](#).

HARDWARE							
	Accepts Insert Series	Seat	Clamp	Clamp Screw	Lock Pin	Clamp Screw Wrench	Lock Pin Wrench
MRGNL12-4B	RNM_43_	IRSN43	CL9	XNS59	NL46	5/32HEX	AG00093LLA 3/32"
MRGNL16-4D	RNM_43_	IRSN43	CL9	XNS59	NL46	5/32HEX	AG00093LLA 3/32"
MRGNL20-4D	RNM_43_	IRSN43	CL9	XNS59	NL46	5/32HEX	AG00093LLA 3/32"
MRGNR12-4B	RNM_43_	IRSN43	CL9	XNS59	NL46	5/32HEX	AG00093LLA 3/32"
MRGNR16-4D	RNM_43_	IRSN43	CL9	XNS59	NL46	5/32HEX	AG00093LLA 3/32"
MRGNR20-4D	RNM_43_	IRSN43	CL9	XNS59	NL46	5/32HEX	AG00093LLA 3/32"

EXTERNAL TOOL HOLDER WITH MULTI LOCK CLAMP FOR SN__ SQUARE INSERTS

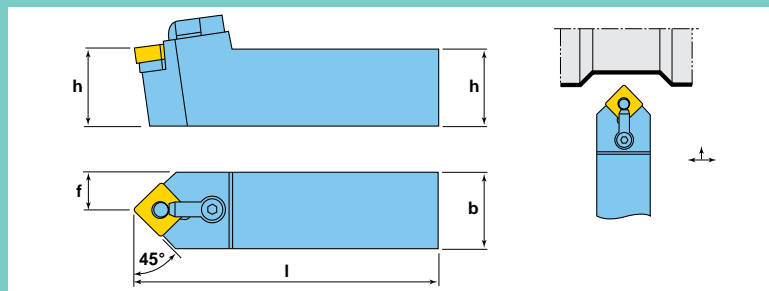

Designation	h	b	l	f
MSDNN10-3B	0.625	0.625	4.500	0.313
MSDNN12-3B	0.750	0.750	4.500	0.375
MSDNN85-4D	1.250	1.000	6.000	0.500
MSDNN16-5D	1.000	1.000	6.000	0.500
MSDNN20-5D	1.250	1.250	6.000	0.625
MSDNN85-5D	1.250	1.000	6.000	0.500
MSDNN20-6E	1.250	1.250	7.000	0.625
MSDNN24-6E	1.500	1.500	7.000	0.750
MSDNN85-6D	1.250	1.000	6.000	0.500

For inserts, see [pages 922 - 931, 1000, 1002, 1013, 1020](#).





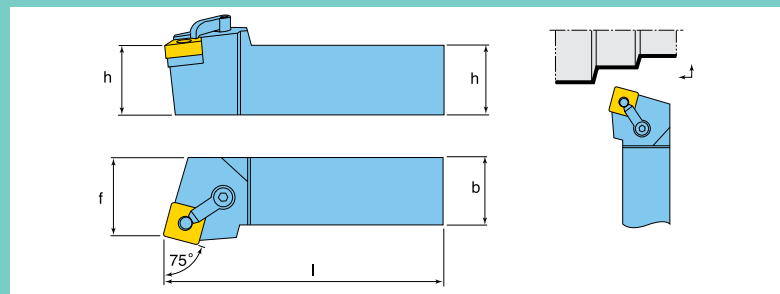

HARDWARE							
	Accepts Insert Series	Seat	Clamp	Clamp Screw	Lock Pin	Clamp Screw Wrench	Lock Pin Wrench
MSDNN10-3B	SN__32__	ISSN322	CL6	XNS36	NL34	AG00093LLA 3/32" AG00078LLA 5/64"	
MSDNN12-3B	SN__32__	ISSN322	CL6	XNS36	NL34	AG00093LLA 3/32" AG00093LLA 3/32"	
MSDNN85-4D	SN__43__	ISSN433	CL9	XNS59	NL46	5/32HEX AG00093LLA 3/32"	
MSDNN16-5D	SN__54__	ISSN533	CL12	XNS510	NL58	5/32HEX AG00125LLA 1/8"	
MSDNN20-5D	SN__54__	ISSN533	CL12	XNS510	NL58	5/32HEX AG00125LLA 1/8"	
MSDNN85-5D	SN__54__	ISSN533	CL12	XNS510	NL58	5/32HEX AG00125LLA 1/8"	
MSDNN20-6E	SN__64__	ISSN633	CL12	XNS510	NL68	5/32HEX AG00140LLA 9/64"	
MSDNN24-6E	SN__64__	ISSN633	CL12	XNS510	NL68	5/32HEX AG00140LLA 9/64"	
MSDNN85-6D	SN__64__	ISSN533	CL12	XNS510	NL58	5/32HEX AG00125LLA 1/8"	

EXTERNAL TOOL HOLDER WITH MULTI LOCK CLAMP FOR SN__ INSERTS



Designation	h	b	l	f
MSRNR10-3B	0.625	0.625	4.500	0.785
MSRNL12-3B	0.750	0.750	4.500	0.910
MSRNR12-3B	0.750	0.750	4.500	0.910
MSRNL16-5D	1.000	1.000	6.000	1.103
MSRNR16-5D	1.000	1.000	6.000	1.103
MSRNL24-6E	1.500	1.500	7.000	1.821
MSRNR24-6E	1.500	1.500	7.000	1.821

For inserts, see [pages 922 - 931](#), [1000](#), [1002](#), [1013](#), [1020](#).





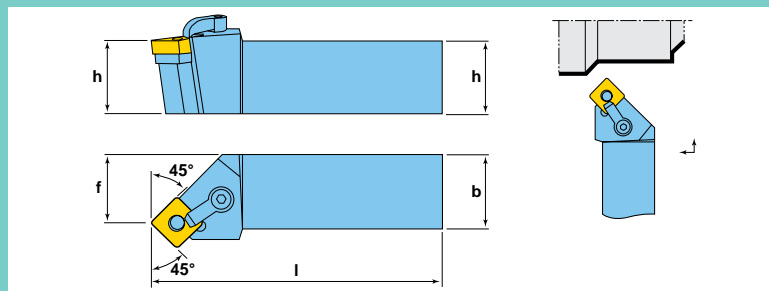

HARDWARE							
	Accepts Insert Series	Seat	Clamp	Clamp Screw	Lock Pin	Clamp Screw Wrench	Lock Pin Wrench
MSRNR10-3B	SN_32_	ISSN322	CL6	XNS36	NL34	AG00093LLA 3/32"	AG00078LLA 5/64"
MSRNL12-3B	SN_32_	ISSN322	CL6	XNS36	NL34	AG00093LLA 3/32"	AG00078LLA 5/64"
MSRNR12-3B	SN_32_	ISSN322	CL6	XNS36	NL34	AG00093LLA 3/32"	AG00078LLA 5/64"
MSRNL16-5D	SN_54_	ISSN533	CL12	XNS510	NL58	5/32HEX	AG00125LLA 1/8"
MSRNR16-5D	SN_54_	ISSN533	CL12	XNS510	NL58	5/32HEX	AG00125LLA 1/8"
MSRNL24-6E	SN_64_	ISSN633	CL12	XNS510	NL68	5/32HEX	AG00140LLA 9/64"
MSRNR24-6E	SN_64_	ISSN633	CL12	XNS510	NL68	5/32HEX	AG00140LLA 9/64"

EXTERNAL TOOL HOLDER WITH MULTI LOCK CLAMP FOR SN__ INSERTS



Designation	h	b	l	f
MSSNL12-4B	0.750	0.750	4.500	0.675
MSSNR12-4B	0.750	0.750	4.500	0.675
MSSNL20-5D	1.250	1.250	6.000	1.097
MSSNR20-5D	1.250	1.250	6.000	1.097

For inserts, see [pages 922 - 931, 1000, 1002, 1013, 1020](#).





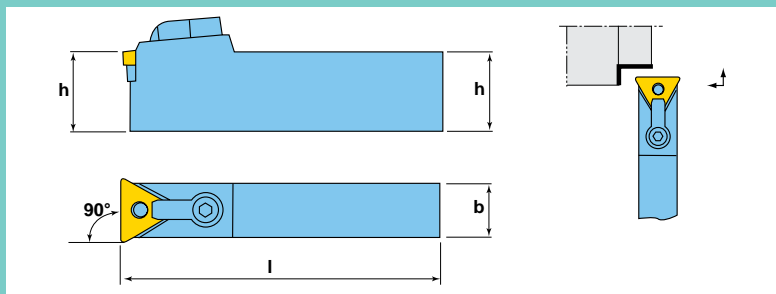

HARDWARE							
	Accepts Insert Series	Seat	Clamp	Clamp Screw	Lock Pin	Clamp Screw Wrench	Lock Pin Wrench
MSSNL12-4B	SN__43__	ISSN433	CL9	XNS59	NL46	5/32HEX	AG00093LLA 3/32"
MSSNR12-4B	SN__43__	ISSN433	CL9	XNS59	NL46	5/32HEX	AG00093LLA 3/32"
MSSNL20-5D	SN__54__	ISSN533	CL9	XNS510	NL58	5/32HEX	AG00125LLA 1/8"
MSSNR20-5D	SN__54__	ISSN533	CL9	XNS510	NL58	5/32HEX	AG00125LLA 1/8"

EXTERNAL TOOL HOLDER WITH MULTI LOCK CLAMP FOR 60° TN_ INSERTS



Designation	h	b	l
MTCNN08-3B	0.500	0.500	4.500
MTCNN12-4B	0.750	0.750	4.500
MTCNN44-3F	1.000	0.500	8.000
MTCNN64-4F	1.000	0.750	8.000
MTCNN66-4F	1.500	0.750	8.000

For inserts, see [pages 932 - 944](#), [1003](#), [1004](#), [1015](#), [1021](#).

HARDWARE							
	Accepts Insert Series	Seat	Clamp	Clamp Screw	Lock Pin	Clamp Screw Wrench	Lock Pin Wrench
MTCNN08-3B	TN_33_	ITSN322	CL7	XNS36	NL34L	AG00093LLA 3/32"	AG00078LLA 5/64"
MTCNN44-3F	TN_33_	ITSN322	CL7	XNS36	NL34L	AG00093LLA 3/32"	AG00078LLA 5/64"
MTCNN12-4B	TN_43_	ITSN433	CL12	XNS59	NL46	5/32HEX	AG00093LLA 3/32"
MTCNN64-4F	TN_43_	ITSN433	CL12	XNS59	NL46	5/32HEX	AG00093LLA 3/32"
MTCNN66-4F	TN_43_	ITSN433	CL12	XNS59	NL46	5/32HEX	AG00093LLA 3/32"

EXTERNAL TOOL HOLDER WITH MULTI LOCK CLAMP FOR 60° TN_ INSERTS

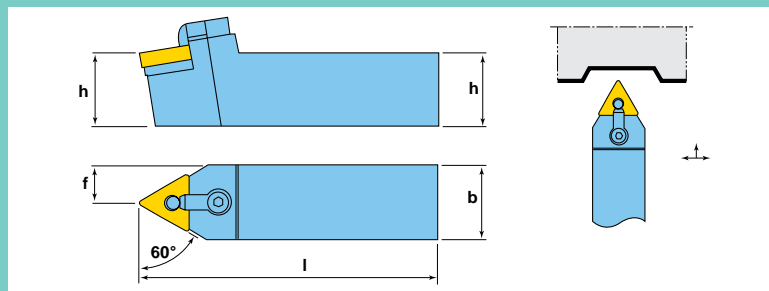

Designation	h	b	l	f
MTENN10-3B	0.625	0.625	4.500	0.312
MTENN12-3B	0.750	0.750	4.500	0.375
MTENN16-4D	1.000	1.000	6.000	0.500
MTENN85-4D	1.250	1.000	6.000	0.500
MTENN20-5E	1.250	1.250	7.000	0.625

For inserts, see [pages 932 - 944, 1003, 1004, 1015, 1021](#).

HARDWARE							
	Accepts Insert Series	Seat	Clamp	Clamp Screw	Lock Pin	Clamp Screw Wrench	Lock Pin Wrench
MTENN10-3B	TN_33_	ITSN322	CL6	XNS36	NL34L	AG00093LLA 3/32"	AG00078LLA 5/64"
MTENN12-3B	TN_33_	ITSN322	CL6	XNS36	NL34L	AG00093LLA 3/32"	AG00078LLA 5/64"
MTENN16-4D	TN_43_	ITSN433	CL9	XNS59	NL46	5/32HEX	AG00093LLA 3/32"
MTENN85-4D	TN_43_	ITSN433	CL9	XNS59	NL46	5/32HEX	AG00093LLA 3/32"
MTENN20-5E	TN_54_	ITSN533	CL9	XNS510	NL58	5/32HEX	AG00125LLA 1/8"

EXTERNAL TOOL HOLDER WITH MULTI LOCK CLAMP FOR 60° TN_ INSERTS

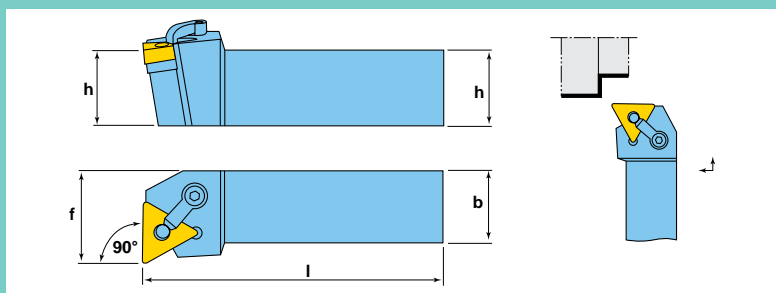

Designation	h	b	l	f
MTFNL08-2A	0.625	0.625	4.500	0.875
MTFNR08-2A	0.625	0.625	4.500	0.875
MTFNL10-3B	0.625	0.625	4.500	0.875
MTFNR10-3B	0.625	0.625	4.500	0.875
MTFNL20-4D	1.250	1.250	6.000	1.500
MTFNR20-4D	1.250	1.250	6.000	1.500
MTFNL16-5D	1.000	1.000	6.000	1.250
MTFNR16-5D	1.000	1.000	6.000	1.250
MTFNL20-5D	1.250	1.250	6.000	1.500
MTFNR20-5D	1.250	1.250	6.000	1.500
MTFNL24-5E	1.500	1.500	7.000	2.000
MTFNR24-5E	1.500	1.500	7.000	2.000
MTFNL24-6E	1.500	1.500	7.000	2.000
MTFNR24-6E	1.500	1.500	7.000	2.000

For inserts, see [pages 932 - 944, 1003, 1004, 1015, 1021](#).

HARDWARE							
	Accepts Insert Series	Seat	Clamp	Clamp Screw	Lock Pin	Clamp Screw Wrench	Lock Pin Wrench
MTFNL08-2A	TN_22_	-	CL19	XNS36	NL23	AG00093LLA 3/32" AG00062LLA 1/16"	
MTFNR08-2A	TN_22_	-	CL19	XNS36	NL23	AG00093LLA 3/32" AG00062LLA 1/16"	
MTFNL10-3B	TN_33_	ITSN322	CL6	XNS36	NL34L	AG00093LLA 3/32" AG00078LLA 5/64"	
MTFNR10-3B	TN_33_	ITSN322	CL6	XNS36	NL34L	AG00093LLA 3/32" AG00078LLA 5/64"	
MTFNL20-4D	TN_43_	ITSN433	CL9	XNS510	NL46	5/32HEX AG00093LLA 3/32"	
MTFNR20-4D	TN_43_	ITSN433	CL9	XNS510	NL46	5/32HEX AG00093LLA 3/32"	
MTFNL16-5D	TN_54_	ITSN533	CL12	XNS510	NL58	5/32HEX AG00125LLA 1/8"	
MTFNR16-5D	TN_54_	ITSN533	CL12	XNS510	NL58	5/32HEX AG00125LLA 1/8"	
MTFNL20-5D	TN_54_	ITSN533	CL12	XNS510	NL58	5/32HEX AG00125LLA 1/8"	
MTFNR20-5D	TN_54_	ITSN533	CL12	XNS510	NL58	5/32HEX AG00125LLA 1/8"	
MTFNL24-5E	TN_54_	ITSN533	CL12	XNS510	NL58	5/32HEX AG00125LLA 1/8"	
MTFNR24-5E	TN_54_	ITSN533	CL12	XNS510	NL58	5/32HEX AG00125LLA 1/8"	
MTFNL24-6E	TN_66_	ITSN636	CL12	XNS510	NL68L	5/32HEX AG00140LLA 9/64"	
MTFNR24-6E	TN_66_	ITSN636	CL12	XNS510	NL68L	5/32HEX AG00140LLA 9/64"	

EXTERNAL TOOL HOLDER WITH MULTI LOCK CLAMP FOR 60° TN_ INSERTS

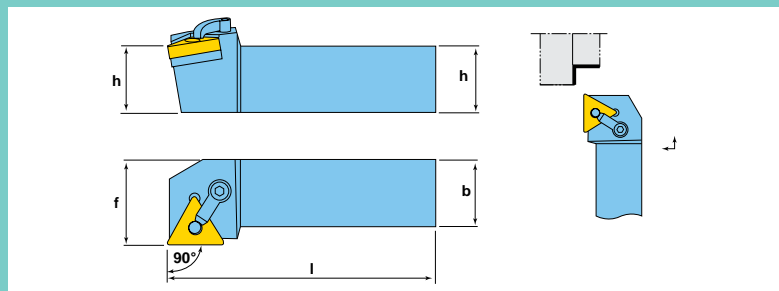

Designation	h	b	l	f
MTGNL10-2B	0.625	0.625	4.500	0.875
MTGNR10-2B	0.625	0.625	4.500	0.875
MTGNL10-3B	0.625	0.625	4.500	0.875
MTGNR10-3B	0.625	0.625	4.500	0.875
MTGNL16-4D	1.000	1.000	6.000	1.250
MTGNR16-4D	1.000	1.000	6.000	1.250
MTGNL20-4D	1.250	1.250	4.500	1.500
MTGNR20-4D	1.250	1.250	4.500	1.500
MTGNL20-5D	1.250	1.250	6.000	1.500
MTGNR20-5D	1.250	1.250	6.000	1.500
MTGNL24-5E	1.500	1.500	7.000	2.000
MTGNR24-5E	1.500	1.500	7.000	2.000
MTGNL24-6E	1.500	1.500	7.000	2.000
MTGNR24-6E	1.500	1.500	7.000	2.000

For inserts, see [pages 932 - 944, 1003, 1004, 1015, 1021](#).

HARDWARE							
	Accepts Insert Series	Seat	Clamp	Clamp Screw	Lock Pin	Clamp Screw Wrench	Lock Pin Wrench
MTGNL10-2B	TN_22_	-	-	XNS36	NL34L	AG00093LLA 3/32" AG00062LLA 1/16"	
MTGNR10-2B	TN_22_	-	-	XNS36	NL34L	AG00093LLA 3/32" AG00062LLA 1/16"	
MTGNL10-3B	TN_33_	ITSN322	CL6	XNS36	NL34L	AG00093LLA 3/32" AG00078LLA 5/64"	
MTGNR10-3B	TN_33_	ITSN322	CL6	XNS36	NL34L	AG00093LLA 3/32" AG00078LLA 5/64"	
MTGNL16-4D	TN_43_	ITSN433	CL9	XNS510	NL46	5/32HEX AG00093LLA 3/32"	
MTGNR16-4D	TN_43_	ITSN433	CL9	XNS510	NL46	5/32HEX AG00093LLA 3/32"	
MTGNL20-4D	TN_43_	ITSN433	CL9	XNS510	NL46	5/32HEX AG00093LLA 3/32"	
MTGNR20-4D	TN_43_	ITSN433	CL9	XNS510	NL46	5/32HEX AG00093LLA 3/32"	
MTGNL20-5D	TN_54_	ITSN533	CL9	XNS510	NL58	5/32HEX AG00125LLA 1/8"	
MTGNR20-5D	TN_54_	ITSN533	CL9	XNS510	NL58	5/32HEX AG00125LLA 1/8"	
MTGNL24-5E	TN_54_	ITSN533	CL9	XNS510	NL58	5/32HEX AG00125LLA 1/8"	
MTGNR24-5E	TN_54_	ITSN533	CL9	XNS510	NL58	5/32HEX AG00125LLA 1/8"	
MTGNL24-6E	TN_66_	ITSN636	CL12	XNS510	NL68L	5/32HEX AG00140LLA 9/64"	
MTGNR24-6E	TN_66_	ITSN636	CL12	XNS510	NL68L	5/32HEX AG00140LLA 9/64"	

EXTERNAL TOOL HOLDER WITH MULTI LOCK CLAMP FOR 60° TN_ INSERTS

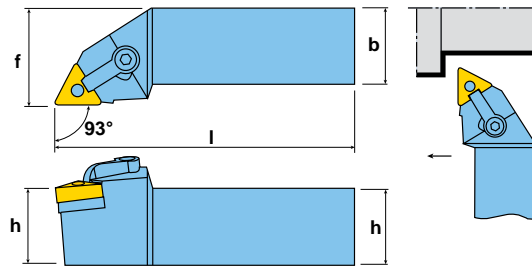

Designation	h	b	l	f
MTJNL10-2B	0.625	0.625	4.500	0.750
MTJNR10-2B	0.625	0.625	4.500	0.750
MTJNL10-3B	0.625	0.625	4.500	0.875
MTJNR10-3B	0.625	0.625	4.500	0.875
MTJNL12-3B	0.750	0.750	4.500	1.000
MTJNR12-3B	0.750	0.750	4.500	1.000
MTJNL16-3D	1.000	1.000	6.000	1.250
MTJNR16-3D	1.000	1.000	6.000	1.250
MTJNL16-4D	1.000	1.000	6.000	1.250
MTJNR16-4D	1.000	1.000	6.000	1.250
MTJNL20-4D	1.250	1.250	6.000	1.500
MTJNR20-4D	1.250	1.250	6.000	1.500
MTJNL16-5D	1.000	1.000	6.000	1.250
MTJNR16-5D	1.000	1.000	6.000	1.250
MTJNL20-5D	1.250	1.250	6.000	1.500
MTJNR20-5D	1.250	1.250	6.000	1.500
MTJNL24-5E	1.500	1.500	7.000	2.000
MTJNR24-5E	1.500	1.500	7.000	2.000
MTJNL24-6E	1.500	1.500	7.000	2.000
MTJNR24-6E	1.500	1.500	7.000	2.000

For inserts, see [pages 932 - 944, 1003, 1004, 1015, 1021](#).

EXTERNAL TOOL HOLDER WITH MULTI LOCK CLAMP FOR 60° TN_ INSERTS

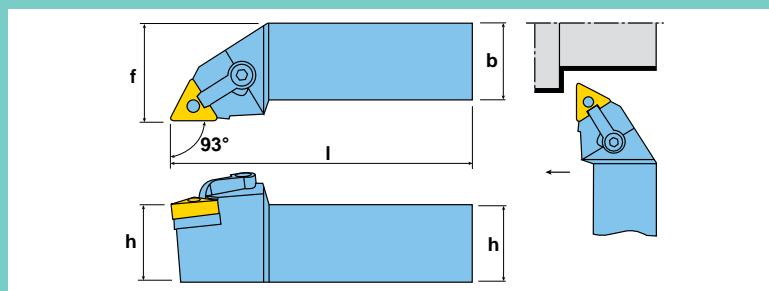

HARDWARE							
	Accepts Insert Series	Seat	Clamp	Clamp Screw	Lock Pin	Clamp Screw Wrench	Lock Pin Wrench
MTJNL10-2B	TN_22_	-	CL19	XNS36	NL23	AG00093LLA 3/32" AG00062LLA 1/16"	
MTJNR10-2B	TN_22_	-	CL19	XNS36	NL23	AG00093LLA 3/32" AG00062LLA 1/16"	
MTJNL10-3B	TN_33_	ITSN322	CL6	XNS36	NL34L	AG00093LLA 3/32" AG00078LLA 5/64"	
MTJNR10-3B	TN_33_	ITSN322	CL6	XNS36	NL34L	AG00093LLA 3/32" AG00078LLA 5/64"	
MTJNL12-3B	TN_33_	ITSN322	CL6	XNS36	NL34L	AG00093LLA 3/32" AG00078LLA 5/64"	
MTJNR12-3B	TN_33_	ITSN322	CL6	XNS36	NL34L	AG00093LLA 3/32" AG00078LLA 5/64"	
MTJNL16-3D	TN_33_	ITSN322	CL6	XNS36	NL34L	AG00093LLA 3/32" AG00078LLA 5/64"	
MTJNR16-3D	TN_33_	ITSN322	CL6	XNS36	NL34L	AG00093LLA 3/32" AG00078LLA 5/64"	
MTJNL16-4D	TN_43_	ITSN433	CL9	XNS510	NL46	5/32HEX AG00093LLA 3/32"	
MTJNR16-4D	TN_43_	ITSN433	CL9	XNS510	NL46	5/32HEX AG00093LLA 3/32"	
MTJNL20-4D	TN_43_	ITSN433	CL9	XNS510	NL46	5/32HEX AG00093LLA 3/32"	
MTJNR20-4D	TN_43_	ITSN433	CL9	XNS510	NL46	5/32HEX AG00093LLA 3/32"	
MTJNL16-5D	TN_54_	ITSN533	CL9	XNS510	NL58	5/32HEX AG00093LLA 3/32"	
MTJNR16-5D	TN_54_	ITSN533	CL9	XNS510	NL58	5/32HEX AG00093LLA 3/32"	
MTJNL20-5D	TN_54_	ITSN533	CL9	XNS510	NL58	5/32HEX AG00125LLA 1/8"	
MTJNR20-5D	TN_54_	ITSN533	CL9	XNS510	NL58	5/32HEX AG00125LLA 1/8"	
MTJNL24-5E	TN_54_	ITSN533	CL9	XNS510	NL58	5/32HEX AG00125LLA 1/8"	
MTJNR24-5E	TN_54_	ITSN533	CL9	XNS510	NL58	5/32HEX AG00125LLA 1/8"	
MTJNL24-6E	TN_66_	ITSN636	CL12	XNS510	NL68L	5/32HEX AG00140LLA 9/64"	
MTJNR24-6E	TN_66_	ITSN636	CL12	XNS510	NL68L	5/32HEX AG00140LLA 9/64"	

For inserts, see [pages 932 - 944, 1003, 1004, 1015, 1021](#).

EXTERNAL TOOL HOLDER WITH MULTI LOCK CLAMP FOR 35° VN__ INSERTS

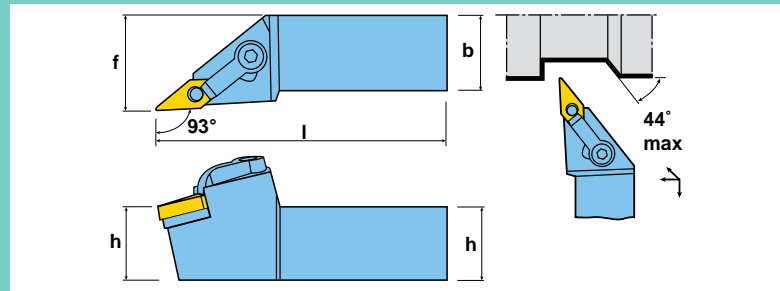

Designation	h	b	l	f
MVJNR12-4B	0.750	0.750	4.500	1.000
MVJNL16-4D	1.000	1.000	6.000	1.250
MVJNR16-4D	1.000	1.000	6.000	1.250
MVJNL20-4D	1.250	1.250	6.000	1.500
MVJNR20-4D	1.250	1.250	6.000	1.500

For inserts, see [page 945](#).

HARDWARE							
	Accepts Insert Series	Seat	Clamp	Clamp Screw	Lock Pin	Clamp Screw Wrench	Lock Pin Wrench
MVJNR12-4B	VN__43__	IVSN433	CL30	XNS510	NL46	5/32HEX	AG00093LLA 3/32"
MVJNL16-4D	VN__43__	IVSN433	CL30	XNS510	NL46	5/32HEX	AG00093LLA 3/32"
MVJNR16-4D	VN__43__	IVSN433	CL30	XNS510	NL46	5/32HEX	AG00093LLA 3/32"
MVJNL20-4D	VN__43__	IVSN433	CL30	XNS510	NL46	5/32HEX	AG00093LLA 3/32"
MVJNR20-4D	VN__43__	IVSN433	CL30	XNS510	NL46	5/32HEX	AG00093LLA 3/32"

EXTERNAL TOOL HOLDER WITH MULTI LOCK CLAMP FOR TRIGON WN__ INSERTS

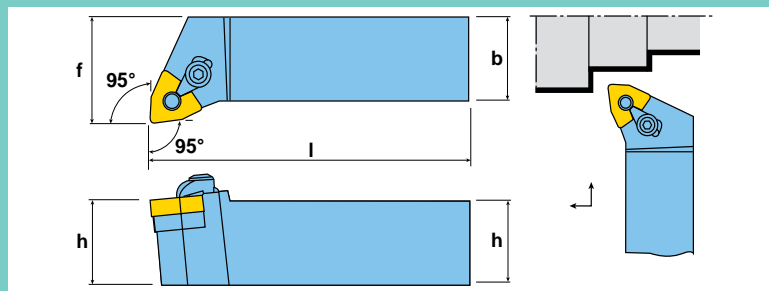

Designation	h	b	l	f
MWLNL12-3B	0.750	0.750	4.500	1.000
MWLN12-3B	0.750	0.750	4.500	1.000
MWLNL16-3C	1.000	1.000	5.000	1.250
MWLN16-3C	1.000	1.000	5.000	1.250
MWLNL12-4B	0.750	0.750	4.500	1.000
MWLN12-4B	0.750	0.750	4.500	1.000
MWLNL16-4D	1.000	1.000	5.000	1.250
MWLN16-4D	1.000	1.000	5.000	1.250
MWLNL20-4D	1.250	1.250	6.000	1.500
MWLN20-4D	1.250	1.250	6.000	1.500

For inserts, see [pages 950 - 960, 1006, 1007, 1017](#).

HARDWARE							
	Accepts Insert Series	Seat	Clamp	Clamp Screw	Lock Pin	Clamp Screw Wrench	Lock Pin Wrench
MWLNL12-3B	WN__33_	IWSN322	CL6	XNS36	NL34L	AG00093LLA 3/32" AG00078LLA 5/64"	
MWLN12-3B	WN__33_	IWSN322	CL6	XNS36	NL34L	AG00093LLA 3/32" AG00078LLA 5/64"	
MWLNL16-3C	WN__33_	IWSN322	CL6	XNS36	NL34L	AG00093LLA 3/32" AG00078LLA 5/64"	
MWLN16-3C	WN__33_	IWSN322	CL6	XNS36	NL34L	AG00093LLA 3/32" AG00078LLA 5/64"	
MWLNL12-4B	WN__43_	IWSN432	CL9	XNS59	NL46	5/32HEX AG00093LLA 3/32"	
MWLN12-4B	WN__43_	IWSN432	CL9	XNS59	NL46	5/32HEX AG00093LLA 3/32"	
MWLNL16-4D	WN__43_	IWSN433	CL20	XNS48	NL46	AG00125LLA 1/8" AG00093LLA 3/32"	
MWLN16-4D	WN__43_	IWSN433	CL20	XNS48	NL46	AG00125LLA 1/8" AG00093LLA 3/32"	
MWLNL20-4D	WN__43_	IWSN432	CL9	XNS59	NL46	5/32HEX AG00093LLA 3/32"	
MWLN20-4D	WN__43_	IWSN432	CL9	XNS59	NL46	5/32HEX AG00093LLA 3/32"	

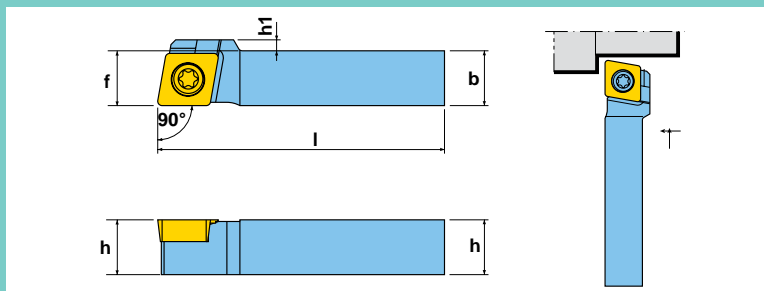

TOTURN™ SCACR-SH

EXTERNAL TOOL HOLDER WITH SCREW CLAMPING AND SHORT HEAD FOR POSITIVE 80° CC__ INSERTS



Designation	h	b	l	f	h1
Inch					
SCACR06-2C-SH	0.375	0.375	5.000	0.375	-
SCACR08-3C-SH	0.500	0.500	5.000	0.500	-
SCACR10-3C-SH	0.625	0.625	5.000	0.625	-
Metric					
SCACR0808K06-SH	8mm	8mm	125mm	8mm	-
SCACR1010K06-SH	10mm	10mm	125mm	10mm	-
SCACR1010K09-SH	10mm	10mm	125mm	10mm	2mm
SCACR1212K09-SH	12mm	12mm	125mm	12mm	-
SCACR1616K09-SH	16mm	16mm	125mm	16mm	-

For inserts, see [pages 961 - 965, 990, 1008 & 1018](#).

HARDWARE			
			
Accepts Insert Series	Insert Screw	Torx Driver	
Inch			
SCACR06-2C-SH	CC_T21.5_	SM25-065-70	DS-T07F
SCACR08-3C-SH	CC_T21.5_	S035080I	DS-T15S
SCACR10-3C-SH	CC_T32.5_	S035080I	DS-T15S
Metric			
SCACR0808K06-SH	CC_T21.5_	SM25-065-70	DS-T07F
SCACR1010K06-SH	CC_T21.5_	SM25-065-70	DS-T07F
SCACR1010K09-SH	CC_T32.5_	S035080I	DS-T15S
SCACR1212K09-SH	CC_T32.5_	S035080I	DS-T15S
SCACR1616K09-SH	CC_T32.5_	S035080I	DS-T15S

EXTERNAL TOOL HOLDER WITH SCREW CLAMPING AND FOR POSITIVE 80° CC__ INSERTS

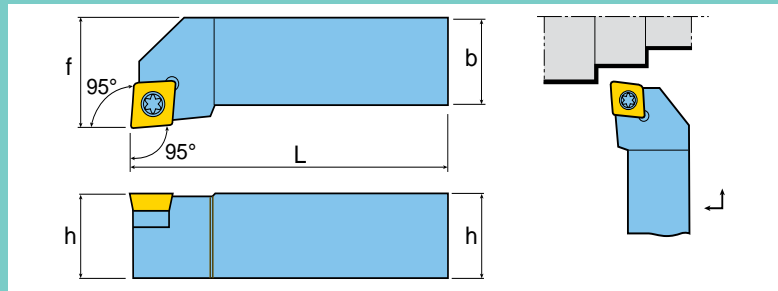

Designation	h	b	l	f
SCLCL06-3K	0.375	0.375	2.500	0.500
SCLCR06-3K	0.375	0.375	2.500	0.500
SCLCL08-3A	0.500	0.500	4.000	0.625
SCLCR08-3A	0.500	0.500	4.000	0.625
SCLCL10-3B	0.625	0.625	4.500	0.750
SCLCR10-3B	0.625	0.625	4.500	0.750
SCLCL12-3B	0.750	0.750	4.500	1.000
SCLCR12-3B	0.750	0.750	4.500	1.000
SCLCL16-3D	1.000	1.000	6.000	1.250
SCLCR16-3D	1.000	1.000	6.000	1.250
SCLCL12-4B	0.750	0.750	4.500	1.000
SCLCR12-4B	0.750	0.750	4.500	1.000
SCLCL16-4D	1.000	1.000	6.000	1.250
SCLCR16-4D	1.000	1.000	6.000	1.250
SCLCR20-4D	1.250	1.250	6.000	1.500

For inserts, see [pages 961 - 965, 990, 1008 & 1018](#).

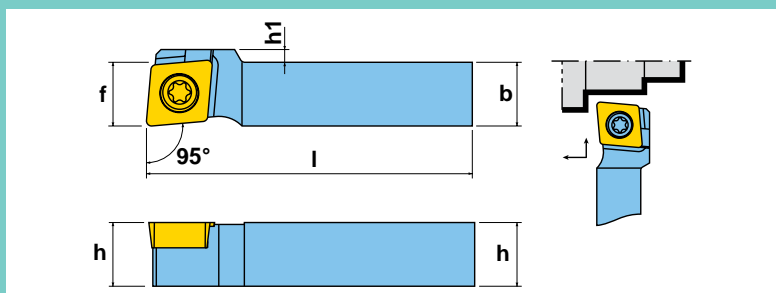

HARDWARE						
	Accepts Insert Series	Seat	Insert Screw	Seat Screw	Seat Screw Wrench	Torx Driver
SCLCL06-3K	CC_T32.5_	-	SR16-236P	-	-	DS-T15S
SCLCR06-3K	CC_T32.5_	-	SR16-236P	-	-	DS-T15S
SCLCL08-3A	CC_T32.5_	-	TS-4.7-10M1	-	-	DS-T15S
SCLCR08-3A	CC_T32.5_	-	TS-4.7-10M1	-	-	DS-T15S
SCLCL10-3B	CC_T32.5_	-	TS-4.7-10M1	-	-	DS-T15S
SCLCR10-3B	CC_T32.5_	-	TS-4.7-10M1	-	-	DS-T15S
SCLCL12-3B	CC_T32.5_	-	TS-4.7-10M1	-	-	DS-T15S
SCLCR12-3B	CC_T32.5_	-	TS-4.7-10M1	-	-	DS-T15S
SCLCL16-3D	CC_T32.5_	-	TS-4.7-10M1	-	-	5515
SCLCR16-3D	CC_T32.5_	-	TS-4.7-10M1	-	-	5515
SCLCL12-4B	CC_T43_	-	TS-5.8-10M1	-	-	DS-T20T
SCLCR12-4B	CC_T43_	-	TS-5.8-10M1	-	-	DS-T20T
SCLCL16-4D	CC_T43_	3614(SEAT)	1540	1760	L-W4	5517
SCLCR16-4D	CC_T43_	3614(SEAT)	1540	1760	L-W4	5517
SCLCR20-4D	CC_T43_	-	TS-5.8-10M1	-	-	DS-T20T

EXTERNAL TOOL HOLDER WITH SCREW CLAMPING AND SHORT HEAD FOR POSITIVE 80° CC__ INSERTS



Designation	h	b	l	f	h1
Inch					
SCLCR06-2C-SH	0.375	0.375	5.000	0.375	-
SCLCR08-3C-SH	0.500	0.500	5.000	0.500	-
SCLCR10-3C-SH	0.625	0.625	5.000	0.625	-
Metric					
SCLCR0808K06-SH	8mm	8mm	125mm	8mm	-
SCLCR1010K06-SH	10mm	10mm	125mm	10mm	-
SCLCR1010K09-SH	10mm	10mm	125mm	10mm	2mm
SCLCR1212K09-SH	12mm	12mm	125mm	12mm	-
SCLCR1616K09-SH	16mm	16mm	125mm	12mm	-

For inserts, see [pages 961 - 965, 990, 1008 & 1018](#).

HARDWARE			
			
Accepts Insert Series	Insert Screw	Torx Driver	
Inch			
SCLCR06-2C-SH	CC_T21.5_	SM25-065-70	DS-T07F
SCLCR08-3C-SH	CC_T32.5_	S035080I	DS-T15T
SCLCR10-3C-SH	CC_T32.5_	S035080I	DS-T15T
Metric			
SCLCR0808K06-SH	CC_T21.5_	SM25-065-70	DS-T07F
SCLCR1010K06-SH	CC_T21.5_	SM25-065-70	DS-T07F
SCLCR1010K09-SH	CC_T32.5_	S035080I	DS-T15T
SCLCR1212K09-SH	CC_T32.5_	S035080I	DS-T15T
SCLCR1616K09-SH	CC_T32.5_	S035080I	DS-T15T

EXTERNAL TOOL HOLDER WITH SCREW CLAMPING FOR POSITIVE 55° DC__ INSERTS

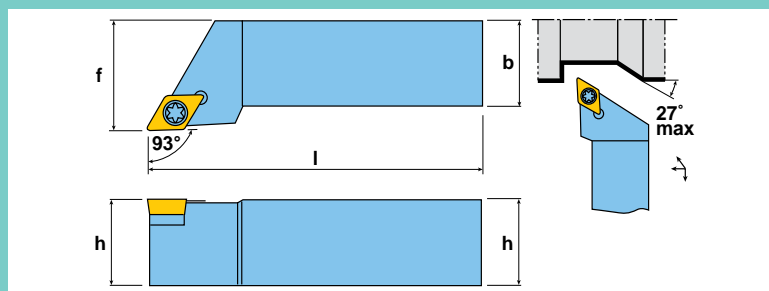

Designation	h	b	l	f
SDJCR06-2J	0.375	0.375	2.500	0.500
SDJCL08-2A	0.500	0.500	4.000	0.625
SDJCR08-2A	0.500	0.500	4.000	0.625
SDJCL08-3A	0.500	0.500	4.000	0.625
SDJCR08-3A	0.500	0.500	4.000	0.625
SDJCR10-3B	0.625	0.625	4.500	0.750
SDJCL10-3B	0.625	0.625	4.500	0.750
SDJCL12-3B	0.750	0.750	4.500	1.000
SDJCR12-3B	0.750	0.750	4.500	1.000
SDJCL16-3D	1.000	1.000	6.000	1.250
SDJCR16-3D	1.000	1.000	6.000	1.250

For inserts, see [pages 967 - 970, 990, 1010, 1019](#).

HARDWARE						
	Accepts Insert Series	Seat	Insert Screw	Seat Screw	Seat Screw Wrench	Torx Driver
SDJCR06-2J	DC_T21.5_	-	TS-25.45-6M1	-	-	DS-T07F
SDJCL08-2A	DC_T21.5_	-	TS-25.45-6M1	-	-	DS-T07F
SDJCR08-2A	DC_T21.5_	-	TS-25.45-6M1	-	-	DS-T07F
SDJCL08-3A	DC_T32.5_	-	TS-4.7-10M1	-	-	DS-T15S
SDJCR08-3A	DC_T32.5_	-	TS-4.7-10M1	-	-	DS-T15S
SDJCR10-3B	DC_T32.5_	-	TS-4.7-10M1	-	-	DS-T15S
SDJCL10-3B	DC_T32.5_	-	TS-4.7-10M1	-	-	DS-T15S
SDJCL12-3B	DC_T32.5_	-	TS-4.7-10M1	-	-	DS-T15S
SDJCR12-3B	DC_T32.5_	-	TS-4.7-10M1	-	-	DS-T15S
SDJCL16-3D	DC_T32.5_	3714	1335	1750	AG00140LLA 9/64"	5516
SDJCR16-3D	DC_T32.5_	3714	1335	1750	AG00140LLA 9/64"	5516

EXTERNAL TOOL HOLDER WITH SCREW CLAMPING AND SHORT HEAD FOR POSITIVE 55° DC__ INSERTS

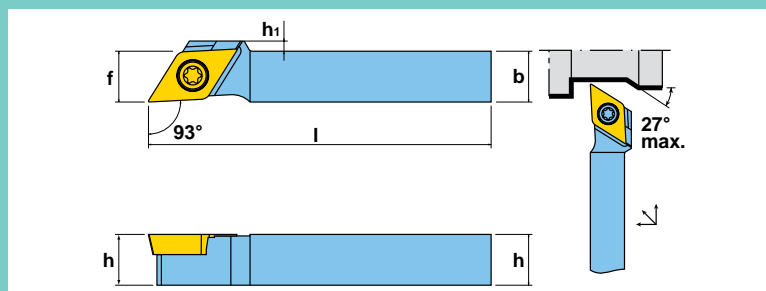

Designation	h	b	l	f	h1
Inch					
SDJCR06-2C-SH	0.375	0.375	5.000	0.375	-
SDJCL08-3C-SH	0.500	0.500	5.000	0.500	-
SDJCR08-3C-SH	0.500	0.500	5.000	0.500	-
SDJCR10-3C-SH	0.625	0.625	5.000	0.625	-
Metric					
SDJCR0808K07-SH	8mm	8mm	125mm	8mm	-
SDJCR1010K07-SH	10mm	10mm	125mm	10mm	-
SDJCR1010K11-SH	10mm	10mm	125mm	10mm	2mm
SDJCL1212K11-SH	12mm	12mm	125mm	12mm	-
SDJCR1212K11-SH	12mm	12mm	125mm	12.000	-
SDJCR1616K11-SH	16mm	16mm	125mm	16mm	-

For inserts, see pages 967 - 970, 990, 1010, 1019.

HARDWARE





Accepts Insert Series
Insert Screw
Torx Driver





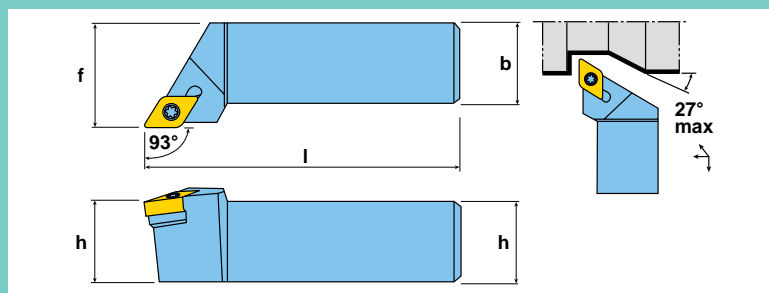

Inch			
SDJCR06-2C-SH	DC_T21.5_	SM25-065-70	DS-T07F
SDJCL08-3C-SH	DC_T32.5_	SM25-065-70	DS-T07F
SDJCR08-3C-SH	DC_T32.5_	SM25-065-70	DS-T07F
SDJCR10-3C-SH	DC_T32.5_	S035080I	DS-T15T
Metric			
SDJCR0808K07-SH	DC_T21.5_	SM25-065-70	DS-T07F
SDJCR1010K07-SH	DC_T21.5_	SM25-065-70	DS-T07F
SDJCR1010K11-SH	DC_T32.5_	S035080I	DS-T15T
SDJCL1212K11-SH	DC_T32.5_	S035080I	DS-T15T
SDJCR1212K11-SH	DC_T32.5_	S035080I	DS-T15T
SDJCR1616K11-SH	DC_T32.5_	S035080I	DS-T15T

EXTERNAL TOOL HOLDER WITH SCREW CLAMPING AND FOR NEGATIVE 55° DN__ INSERTS



Designation	h	b	l	f
SDJNL10-3A	0.625	0.625	4.000	0.750
SDJNR10-3A	0.625	0.625	4.000	0.750
SDJNR12-3B	0.750	0.750	4.500	1.000

For inserts, see [pages 909, 911, 912, 915, 916](#).

HARDWARE						
	Accepts Insert Series	Seat	Insert Screw	Seat Screw	Seat Screw Wrench	Torx Driver
SDJNL10-3A	DN__33__	SSD32	S035120I	S050090S	L-W4	DS-T10T
SDJNR10-3A	DN__33__	SSD32	S035120I	S050090S	L-W4	DS-T10T
SDJNR12-3B	DN__33__	SSD32	S035120I	S050090S	L-W4	DS-T10T

EXTERNAL TOOL HOLDER WITH SCREW CLAMPING AND SHORT HEAD FOR POSITIVE 55° DC__ INSERTS

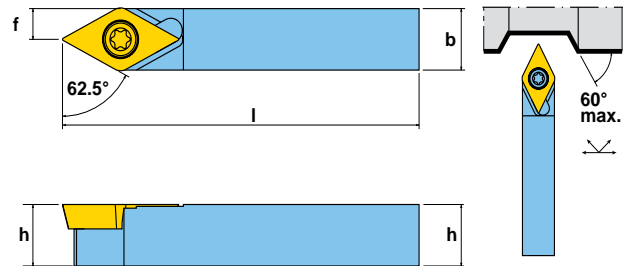

Designation	h	b	l	f
Inch				
SDNCN06-2C-SH	0.375	0.375	5.000	0.188
SDNCN08-3C-SH	0.500	0.500	5.000	0.250
SDNCN10-3C-SH	0.625	0.625	5.000	0.375
Metric				
SDNCN0808K07-SH	8mm	8mm	125mm	4mm
SDNCN1010K07-SH	10mm	10mm	125mm	5mm
SDNCN1010K11-SH	10mm	10mm	125mm	5mm
SDNCN1212K11-SH	12mm	12mm	125mm	6mm
SDNCN1616K11-SH	16mm	16mm	125mm	8mm

For inserts, see [pages 967 - 970, 990, 1010, 1019](#).

HARDWARE

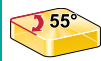

Accepts Insert Series



Insert Screw



Torx Driver

Inch

SDNCN06-2C-SH	DC_T21.5_	SM25-065-70	DS-T07F
SDNCN08-3C-SH	DC_T32.5_	SM25-065-70	DS-T07F
SDNCN10-3C-SH	DC_T32.5_	S035080I	DS-T15T

Metric

SDNCN0808K07-SH	DC_T21.5_	SM25-065-70	DS-T07F
SDNCN1010K07-SH	DC_T21.5_	SM25-065-70	DS-T07F
SDNCN1010K11-SH	DC_T32.5_	S035080I	DS-T15T
SDNCN1212K11-SH	DC_T32.5_	S035080I	DS-T15T
SDNCN1616K11-SH	DC_T32.5_	S035080I	DS-T15T

EXTERNAL TOOL HOLDER WITH SCREW CLAMPING FOR POSITIVE 55° DC__ INSERTS

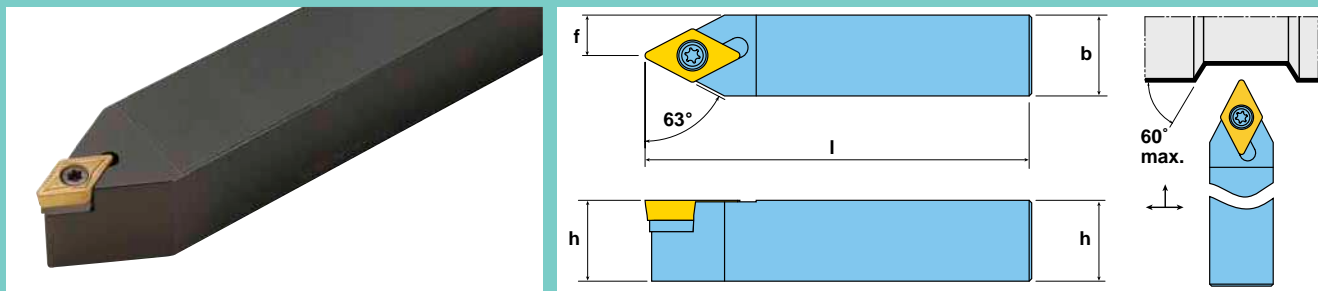

Designation	h	b	l	f
SDPCN08-3J	0.500	0.500	3.500	0.250
SDPCN10-3B	0.625	0.625	4.500	0.312
SDPCN12-3B	0.750	0.750	4.500	0.375
SDPCN16-3D	1.000	1.000	6.000	0.500

For inserts, see pages 967 - 970, 990, 1010, 1019.



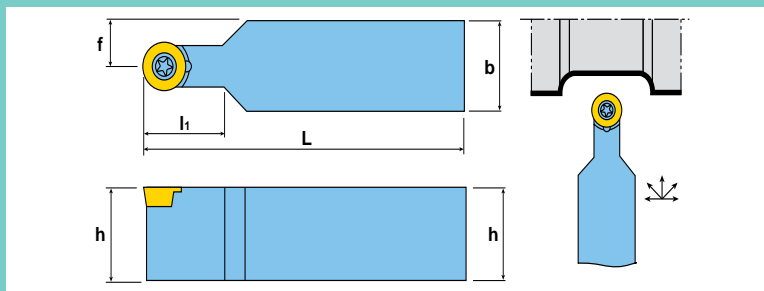

HARDWARE						
	Accepts Insert Series	Seat	Insert Screw	Seat Screw	Seat Screw Wrench	Torx Driver
SDPCN08-3J	DC_T32.5_	-	SR16-236P	-	-	DS-T15S
SDPCN10-3B	DC_T32.5_	-	1335	-	-	DS-T15S
SDPCN12-3B	DC_T32.5_	-	1335	-	-	DS-T15S
SDPCN16-3D	DC_T32.5_	3714	1335	1750	AG00140LLA 9/64"	5516

EXTERNAL TOOL HOLDER WITH SCREW CLAMPING FOR POSITIVE ROUND INSERTS



Designation	h	b	l	f
SRDCN10-3A	0.625	0.625	4.000	0.312
SRDCN12-3B	0.750	0.750	4.500	0.375
SRDCN16-4D	1.000	1.000	6.000	0.500

For inserts, see [pages 971, 991](#).





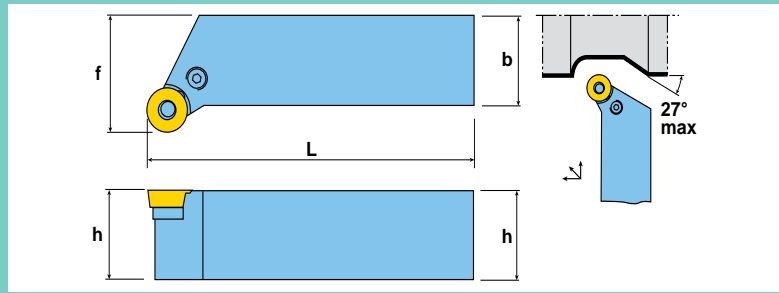

HARDWARE					
	Accepts Insert Series	Seat	Insert Screw	Seat Screw	Torx Driver
SRDCN10-3A	RC_T10T300	3811(SEAT)	1335	1750	5516
SRDCN12-3B	RC_T10T300	3811(SEAT)	1335	1750	5516
SRDCN16-4D	RC_T120400	3814(SEAT)	1335	1750	5516

EXTERNAL TOOL HOLDER WITH SCREW CLAMPING FOR POSITIVE ROUND INSERTS



Designation	h	b	l	f
SRGCL12-3B	0.750	0.750	5.00	1.000
SRGCR12-3B	0.750	0.750	5.00	1.000
SRGCR16-3D	1.000	1.000	6.000	1.250
SRGCL16-4D	1.000	1.000	6.000	1.250
SRGCR16-4D	1.000	1.000	6.000	1.250

For inserts, see [pages 971, 991](#).

HARDWARE						
	Accepts Insert Series	Seat	Insert Screw	Seat Screw	Seat Screw Wrench	Torx Driver
SRGCL12-3B	RC_T10T300	3811(SEAT)	1335	1750	AG00140LLA 9/64"	5516
SRGCR12-3B	RC_T10T300	3811(SEAT)	1335	1750	AG00140LLA 9/64"	5516
SRGCR16-3D	RC_T10T300	3811(SEAT)	1335	1750	AG00140LLA 9/64"	5516
SRGCL16-4D	RC_T120400	3814(SEAT)	1335	1750	AG00140LLA 9/64"	5516
SRGCR16-4D	RC_T120400	3814(SEAT)	1335	1750	AG00140LLA 9/64"	5516

EXTERNAL TOOL HOLDER WITH SCREW CLAMPING FOR POSITIVE 90° SC__ INSERTS

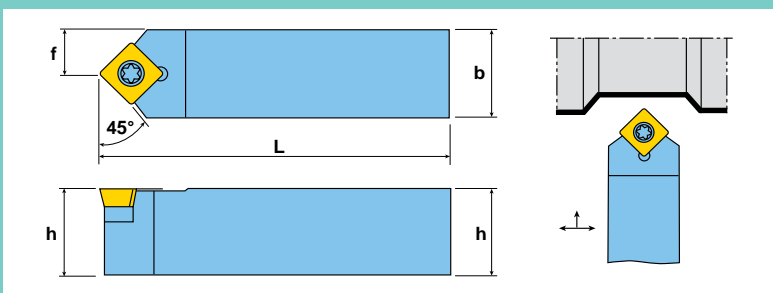

Designation	h	b	l	f
SSDCN08-3A	0.500	0.500	4.000	0.250
SSDCN10-3B	0.625	0.625	4.500	0.375
SSDCN12-3B	0.750	0.750	4.500	0.375
SSDCN12-4B	0.750	0.750	4.500	0.375
SSDCN16-4D	1.000	1.000	6.000	0.500

For inserts, see [pages 973, 974 & 991](#).

HARDWARE			
	Accepts Insert Series	Insert Screw	Torx Driver
SSDCN08-3A	SC_T32.5_	TS-4.7-10M1	DS-T15S
SSDCN10-3B	SC_T32.5_	TS-4.7-10M1	DS-T15S
SSDCN12-3B	SC_T32.5_	TS-4.7-10M1	DS-T15S
SSDCN12-4B	SC_T43_	SR16-212	DS-T20T
SSDCN16-4D	SC_T43_	TS-5.8-10M1	DS-T20T

EXTERNAL TOOL HOLDER WITH SCREW CLAMPING FOR POSITIVE 60° TC__ INSERTS

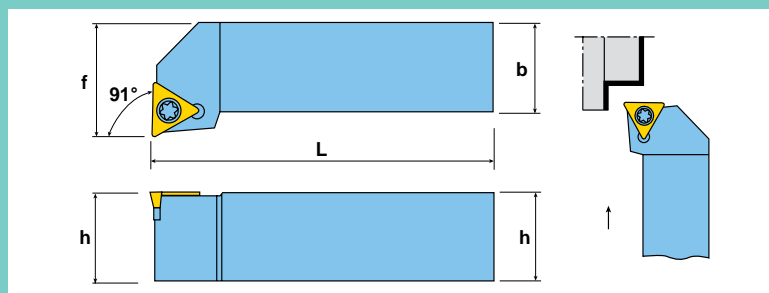

Designation	h	b	l	f
STFCL06-2	0.375	0.375	2.500	0.500
STFCR06-2	0.375	0.375	2.500	0.500
STFCL08-2J	0.500	0.500	3.500	0.625
STFCR08-2J	0.500	0.500	3.500	0.625
STFCL10-2A	0.625	0.625	4.000	0.750
STFCR10-2A	0.625	0.625	4.000	0.750
STFCL12-3B	0.750	0.750	4.500	1.000
STFCR12-3B	0.750	0.750	4.500	1.000
STFCL16-3D	1.000	1.000	6.000	1.250
STFCR16-3D	1.000	1.000	6.000	1.250

For inserts, see [pages 978, 979, 993, 1014, 1020](#).

HARDWARE						
	Accepts Insert Series	Seat	Insert Screw	Seat Screw	Seat Screw Wrench	Torx Driver
STFCL06-2	TC_T21.5_	-	TS-25.45-6M1	-	-	DS-T07F
STFCR06-2	TC_T21.5_	-	TS-25.45-6M1	-	-	DS-T07F
STFCL08-2J	TC_T21.5_	-	TS-25.45-6M1	-	-	DS-T07F
STFCR08-2J	TC_T21.5_	-	TS-25.45-6M1	-	-	DS-T07F
STFCL10-2A	TC_T21.5_	-	TS-25.45-6M1	-	-	DS-T07F
STFCR10-2A	TC_T21.5_	-	TS-25.45-6M1	-	-	DS-T07F
STFCL12-3B	TC_T32.5	3414	1335	1750	AG00140LLA 9/64"	5516
STFCR12-3B	TC_T32.5	3414	1335	1750	-	5516
STFCL16-3D	TC_T32.5	3414	1335	1750	-	5516
STFCR16-3D	TC_T32.5	3414	1335	1750	-	5516

EXTERNAL TOOL HOLDER WITH SCREW CLAMPING FOR POSITIVE 60° TC__ INSERTS

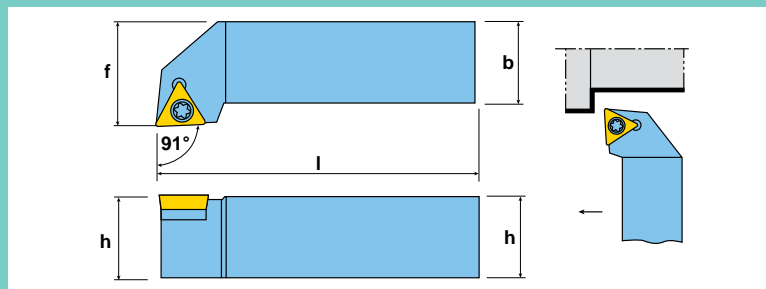

Designation	h	b	l	f
STGCL06-2	0.375	0.375	2.500	0.500
STGCR06-2	0.375	0.375	2.500	0.500
STGCL08-2J	0.500	0.500	3.500	0.625
STGCR08-2J	0.500	0.500	3.500	0.625
STGCR10-2A	0.625	0.625	4.000	0.750
STGCR10-3B	0.625	0.625	4.500	0.750
STGCL12-3B	0.750	0.750	4.500	1.000
STGCR12-3B	0.750	0.750	4.500	1.000
STGCR16-3D	1.000	1.000	6.000	1.000
STGCL16-3D	1.000	1.000	6.000	1.250

For inserts, see [pages 978, 979, 993, 1014, 1020](#).

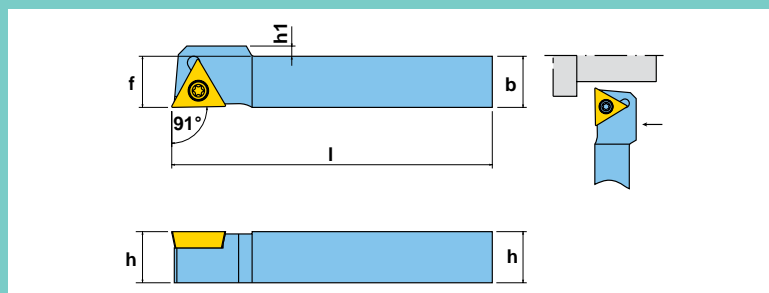

HARDWARE						
	Accepts Insert Series	Seat	Insert Screw	Seat Screw	Seat Screw Wrench	Torx Driver
STGCL06-2	TC_T21.5_	-	TS-25.45-6M1	-	-	DS-T07F
STGCR06-2	TC_T21.5_	-	TS-25.45-6M1	-	-	DS-T07F
STGCL08-2J	TC_T21.5_	-	TS-25.45-6M1	-	-	DS-T07F
STGCR08-2J	TC_T21.5_	-	TS-25.45-6M1	-	-	DS-T07F
STGCR10-2A	TC_T21.5_	-	TS-25.45-6M1	-	-	DS-T07F
STGCR10-3B	TC_T32.5	-	TS-4.7-10M1	-	-	DS-T15S
STGCL12-3B	TC_T32.5	3414	1335	1750	AG00140LLA 9/64"	5516
STGCR12-3B	TC_T32.5	3414	1335	1750	-	5516
STGCR16-3D	TC_T32.5	3414	1335	1750	-	5516
STGCL16-3D	TC_T32.5	3414	1335	1750	-	5516

EXTERNAL TOOL HOLDER WITH SCREW CLAMPING AND SHORT HEAD FOR POSITIVE 60° TC__ INSERTS



Designation	h	b	l	f	h1
Inch					
STGCR06-2C-SH	0.375	0.375	5.000	0.375	0.079
STGCR08-2C-SH	0.500	0.500	5.000	0.500	-
STGCR10-2C-SH	0.625	0.625	5.000	0.625	-
Metric					
STGCR1010K11-SH	10mm	10mm	125mm	10mm	2mm
STGCR1212K11-SH	12mm	12mm	125mm	12mm	-
STGCR1616K11-SH	16mm	16mm	125mm	16mm	-

For inserts, see [page 978](#).

HARDWARE			
			
	Accepts Insert Series	Insert Screw	Torx Driver
Inch			
STGCR06-2C-SH	TC_T22_	SM25-065-70	DS-T07F
STGCR08-2C-SH	TC_T22_	SM25-065-70	DS-T07F
STGCR10-2C-SH	TC_T22_	SM25-065-70	DS-T07F
Metric			
STGCR1010K11-SH	TC_T22_	SM25-065-70	DS-T07F
STGCR1212K11-SH	TC_T22_	SM25-065-70	DS-T07F
STGCR1616K11-SH	TC_T22_	SM25-065-70	DS-T07F

EXTERNAL TOOL HOLDER WITH SCREW CLAMPING FOR POSITIVE 35° VB__ INSERTS

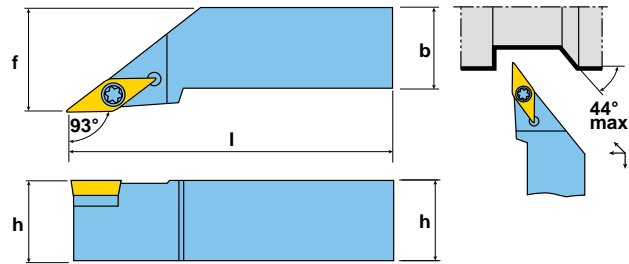

Designation	h	b	l	f
SVJBL12-3B	0.750	0.750	5.000	1.000
SVJBR12-3B	0.750	0.750	5.000	1.000
SVJBL16-3D	1.000	1.000	6.000	1.250
SVJBR16-3D	1.000	1.000	6.000	1.250
SVJBR20-3D	1.250	1.250	6.000	1.500

For inserts, see [pages 987 - 989, 1016, 1022](#).

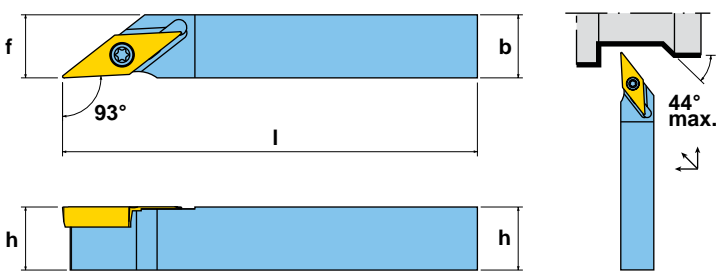

HARDWARE						
	Accepts Insert Series	Seat	Insert Screw	Seat Screw	Seat Screw Wrench	Torx Driver
SVJBL12-3B	VB_T33_	3718	1335	1750	AG00140LLA 9/64"	5516
SVJBR12-3B	VB_T33_	3718	1335	1750	AG00140LLA 9/64"	5516
SVJBL16-3D	VB_T33_	3718	1335	1750	AG00140LLA 9/64"	5516
SVJBR16-3D	VB_T33_	3718	1335	1750	AG00140LLA 9/64"	5516
SVJBR20-3D	VB_T33_	3718	1335	1750	AG00140LLA 9/64"	5516

EXTERNAL TOOL HOLDER WITH SCREW CLAMPING AND SHORT HEAD FOR POSITIVE 35° VB__ INSERTS



Designation	h	b	l	f
Inch				
SVJBR06-2C-SH	0.375	0.375	5.000	0.375
SVJBR08-2C-SH	0.500	0.500	5.000	0.500
SVJBR10-2C-SH	0.625	0.625	5.000	0.625
Metric				
SVJBR1010K11-SH	10mm	10mm	125mm	10mm
SVJBL1212K11-SH	12mm	12mm	125mm	12mm
SVJBR1212K11-SH	12mm	12mm	125mm	12mm
SVJBR1616K11-SH	16mm	16mm	125mm	16mm

For inserts, see [pages 986](#).

HARDWARE			
			
Accepts Insert Series	Torx Driver	Indert Screw	
Inch			
SVJBR06-2C-SH	VB_T22_	DS-T07F	SM25-065-70
SVJBR08-2C-SH	VB_T22_	DS-T07F	SM25-065-70
SVJBR10-2C-SH	VB_T22_	DS-T07F	SM25-065-70
Metric			
SVJBR1010K11-SH	VB_T22_	DS-T07F	SM25-065-70
SVJBL1212K11-SH	VB_T22_	DS-T07F	SM25-065-70
SVJBR1212K11-SH	VB_T22_	DS-T07F	SM25-065-70
SVJBR1616K11-SH	VB_T22_	DS-T07F	SM25-065-70

EXTERNAL TOOL HOLDER WITH SCREW CLAMPING FOR POSITIVE 35° VC__ INSERTS

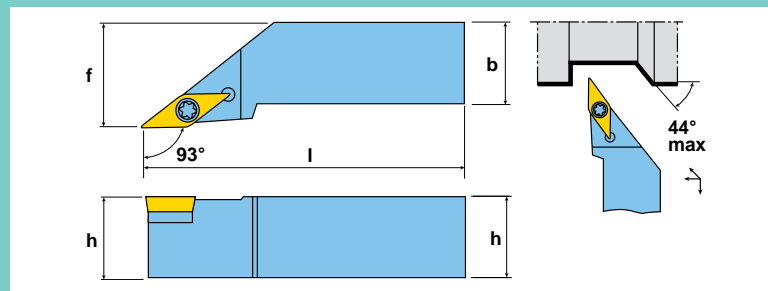

Designation	h	b	l	f
SVJCL08-2A	0.500	0.500	4.000	0.625
SVJCR08-2A	0.500	0.500	4.000	0.625
SVJCL10-2B	0.625	0.625	4.500	0.750
SVJCR10-2B	0.625	0.625	4.500	0.750
SVJCL12-3B	0.750	0.750	4.500	1.000
SVJCR12-3B	0.750	0.750	4.500	1.000
SVJCL16-3D	1.000	1.000	6.000	1.250
SVJCL20-3D	1.250	1.250	6.000	1.500
SVJCR20-3D	1.250	1.250	6.000	1.500
SVJCR16-3D	1.000	1.000	6.000	1.250

For inserts, see [pages 992, 1022](#).

HARDWARE						
	Accepts Insert Series	Seat	Insert Screw	Seat Screw	Seat Screw Wrench	Torx Driver
SVJCL08-2A	VC_T22_	-	TS-25.45-6M1	-	-	DS-T07F
SVJCR08-2A	VC_T22_	-	TS-25.45-6M1	-	-	DS-T07F
SVJCL10-2B	VC_T22_	-	TS-25.45-6M1	-	-	DS-T07F
SVJCR10-2B	VC_T22_	-	TS-25.45-6M1	-	-	DS-T07F
SVJCL12-3B	VC_T33_	3718	1335	1750	AG00140LLA 9/64"	5516
SVJCR12-3B	VC_T33_	3718	1335	1750	AG00140LLA 9/64"	5516
SVJCL16-3D	VC_T33_	3718	1335	1750	AG00140LLA 9/64"	5516
SVJCR16-3D	VC_T33_	3718	1335	1750	AG00140LLA 9/64"	5516
SVJCL20-3D	VC_T33_	3718	1335	1750	AG00140LLA 9/64"	5516
SVJCR20-3D	VC_T33_	3718	1335	1750	AG00140LLA 9/64"	5516

EXTERNAL TOOL HOLDER WITH SCREW CLAMPING FOR NEGATIVE 35° VN__ INSERTS

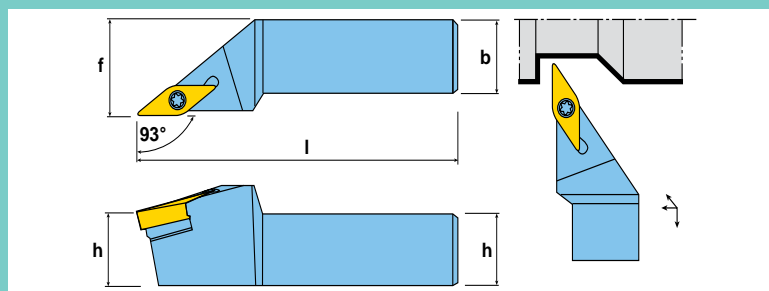

Designation	h	b	l	f
SVJNL10-2.5	0.625	0.625	4.000	0.750
SVJNR10-2.5	0.625	0.625	4.000	0.750
SVJNL12-2.5	0.750	0.750	4.500	1.000
SVJNR12-2.5	0.750	0.750	4.500	1.000
SVJNL16-2.5	1.000	1.000	6.000	1.250
SVJNR16-2.5	1.000	1.000	6.000	1.250



For inserts, see [pages 947, 948](#).

HARDWARE						
	Accepts Insert Series	Seat	Insert Screw	Seat Screw	Seat Screw Wrench	Torx Driver
SVJNL10-2.5	VNMG2.53_	SSVN2.522	S035120I	SM50-062-S0	L-W3.5	DS-T10T
SVJNR10-2.5	VNMG2.53_	SSVN2.522	S035120I	SM50-062-S0	L-W3.5	DS-T10T
SVJNL12-2.5	VNMG2.53_	SSVN2.522	S035120I	SM50-062-S0	L-W3.5	DS-T10T
SVJNR12-2.5	VNMG2.53_	SSVN2.522	S035120I	SM50-062-S0	L-W3.5	DS-T10T
SVJNL16-2.5	VNMG2.53_	SSVN2.522	S035120I	SM50-062-S0	L-W3.5	DS-T10T
SVJNR16-2.5	VNMG2.53_	SSVN2.522	S035120I	SM50-062-S0	L-W3.5	DS-T10T

TOTURN™ SVVBN

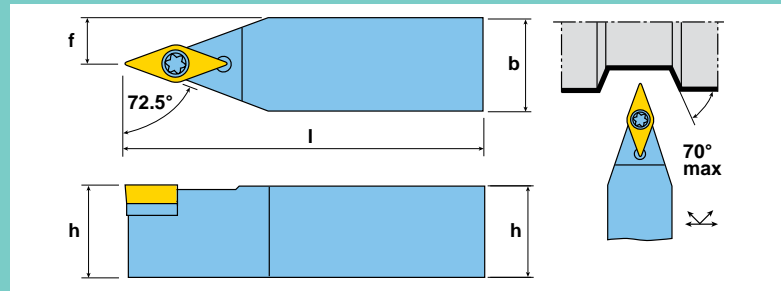
EXTERNAL TOOL HOLDER WITH SCREW CLAMPING FOR POSITIVE 35° VB__ INSERTS







Designation	h	b	l	f			
					Accepts Insert Series	Insert Screw	Torx Driver
SVVBN12-3B	0.750	0.750	4.500	0.375	VB_T33_	TS-4.7-10M1	DS-T155
SVVBN16-3D	1.000	1.000	6.000	0.500	VB_T33_	TS-4.7-10M1	DS-T155
SVVBN20-3D	1.250	1.250	6.000	0.625	VB_T33_	TS-4.7-10M1	DS-T155

For inserts, see [pages 987 - 989, 1016, 1022](#).

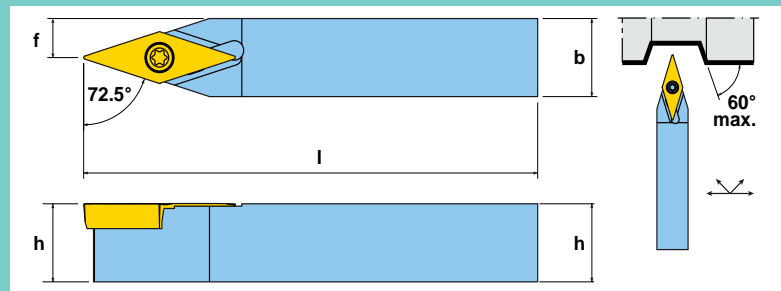
TOTURN™ SVVBN-SH

EXTERNAL TOOL HOLDER WITH SCREW CLAMPING AND SHORT HEAD FOR POSITIVE 35° VB__ INSERTS





Designation	h	b	l	f			
					Accepts Insert Series	Insert Screw	Torx Driver
Inch							
SVVBN06-2C-SH	0.375	0.375	5.000	0.188	VB_T22_	SM25-065-70	DS-T07F
SVVBN08-2C-SH	0.500	0.500	5.000	0.250	VB_T22_	SM25-065-70	DS-T07F
SVVBN10-2C-SH	0.625	0.625	5.000	0.313	VB_T22_	SM25-065-70	DS-T07F
Metric							
SVVBN1010K11-SH	10mm	10mm	125mm	5mm	VB_T22_	SM25-065-70	DS-T07F
SVVBN1212K11-SH	12mm	12mm	125mm	6mm	VB_T22_	SM25-065-70	DS-T07F
SVVBN1616K11-SH	16mm	16mm	125mm	8mm	VB_T22_	SM25-065-70	DS-T07F

For inserts, see [page 986](#).

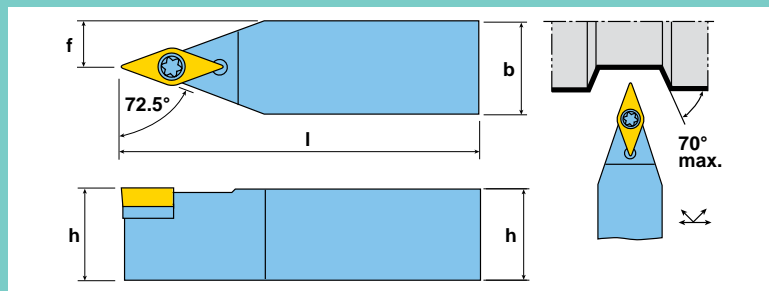
EXTERNAL TOOL HOLDER WITH SCREW CLAMPING FOR POSITIVE 35° VC__ INSERTS



Designation	h	b	l	f	 Accepts Insert Series	 Insert Screw	 Torx Driver
SVVCN12-3B	0.750	0.750	4.500	0.375	VC_T33_	TS-4.7-10M1	DS-T15S
SVVCN16-3D	1.000	1.000	6.000	0.500	VC_T33_	TS-4.7-10M1	DS-T15S

For inserts, see [pages 992 & 1022](#).

EXTERNAL TOOL HOLDER WITH T-TYPE CLAMPING SYSTEM FOR 80° CN__ INSERTS

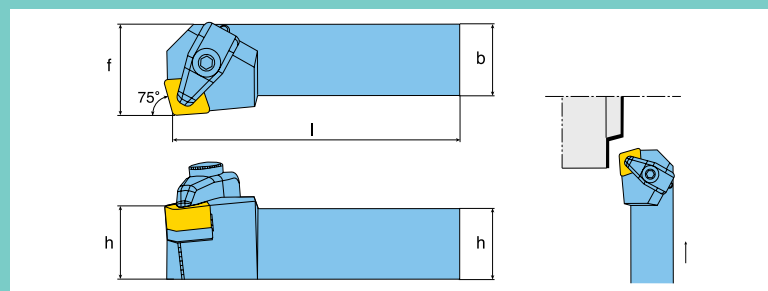

Designation	h	b	l	f
TCKNL12-4B	0.750	0.750	4.500	1.000
TCKNR12-4B	0.750	0.750	4.500	1.000
TCKNL16-4D	1.000	1.000	6.000	1.250
TCKNL16-4D	1.000	1.000	6.000	1.250
TCKNR16-4D	1.000	1.000	6.000	1.250
TCKNL20-4D	1.250	1.250	6.000	1.500
TCKNL20-4D	1.250	1.250	6.000	1.500
TCKNR20-4D	1.250	1.250	6.000	1.500

For inserts, see [pages 894 - 908, 993, 994, 996, 1009, 1018](#).

EXTERNAL TOOL HOLDER WITH T-TYPE CLAMPING SYSTEM FOR 80° CN__ INSERTS

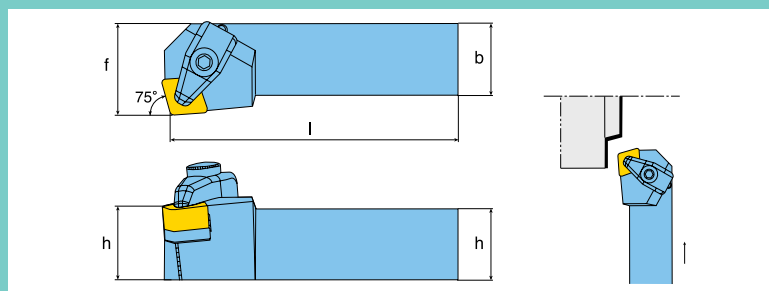

HARDWARE								
	Accepts Insert Series	Seat	Seat Screw	Clamp	Clamp Screw	Clamp Spring	Seat Screw Driver	Clamp Screw Wrench
TCKNL12-4B	CN_43_	TSC44	SO40050I	DLM4	DLS4	DSP4	DS-T15S	L-W3
TCKNR12-4B	CN_43_	TSC44	SO40050I	DLM4	DLS4	DSP4	DS-T15S	L-W3
TCKNL16-4D	CN_43_	TSC44	SO40050I	DLM4	DLS4	DSP4	DS-T15S	L-W3
TCKNL16-4D	CN_43_	TSC44	SO40050I	DLM4	DLS4	DSP4	DS-T15S	L-W3
TCKNR16-4D	CN_43_	TSC44	SO40050I	DLM4	DLS4	DSP4	DS-T15S	L-W3
TCKNL20-4D	CN_43_	TSC44	SO40050I	DLM4	DLS4	DSP4	DS-T15S	L-W3
TCKNL20-4D	CN_43_	TSC44	SO40050I	DLM4	DLS4	DSP4	DS-T15S	L-W3
TCKNR20-4D	CN_43_	TSC44	SO40050I	DLM4	DLS4	DSP4	DS-T15S	L-W3

EXTERNAL TOOL HOLDER WITH T-TYPE CLAMPING SYSTEM FOR 80° CN__ INSERTS

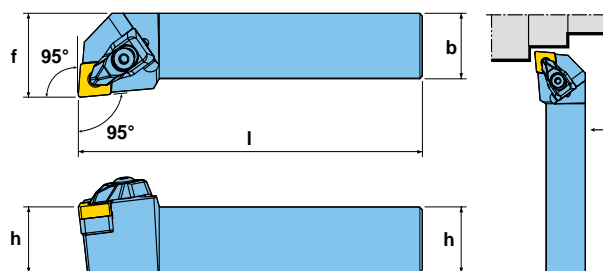

Designation	h	b	l	f
TCLNL12-3B	0.750	0.750	4.500	1.000
TCLNR12-3B	0.750	0.750	4.500	1.000
TCLNL16-3D	1.000	1.000	6.000	1.250
TCLNR16-3D	1.000	1.000	6.000	1.250
TCLNL12-4B	0.750	0.750	4.500	1.000
TCLNR12-4B	0.750	0.750	4.500	1.000
TCLNL16-4D	1.000	1.000	6.000	1.250
TCLNR16-4D	1.000	1.000	6.000	1.250
TCLNL20-4D	1.250	1.250	6.000	1.500
TCLNR20-4D	1.250	1.250	6.000	1.500
TCLNL24-4D	1.500	1.500	6.000	2.000
TCLNR24-4D	1.500	1.500	6.000	2.000
TCLNL16-5D	1.000	1.000	6.000	1.250
TCLNR16-5D	1.000	1.000	6.000	1.250
TCLNL20-5D	1.250	1.250	6.000	1.500
TCLNR20-5D	1.250	1.250	6.000	1.500
TCLNL24-5D	1.500	1.500	6.000	2.000
TCLNR24-5D	1.500	1.500	6.000	2.000
TCLNL16-6D	1.000	1.000	6.000	1.250
TCLNR16-6D	1.000	1.000	6.000	1.250
TCLNL20-6D	1.250	1.250	6.000	1.500
TCLNR20-6D	1.250	1.250	6.000	1.500
TCLNL24-6D	1.500	1.500	6.000	2.000
TCLNR24-6D	1.500	1.500	6.000	2.000

For inserts, see [pages 894 - 908, 993, 994, 996, 1009, 1018](#).

EXTERNAL TOOL HOLDER WITH T-TYPE CLAMPING SYSTEM FOR 80° CN__ INSERTS

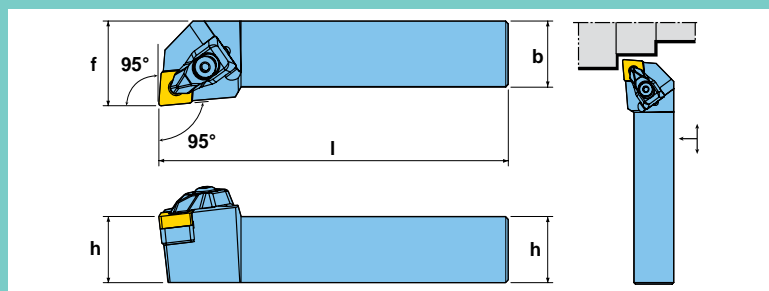

HARDWARE								
	Accepts Insert Series	Seat	Seat Screw	Clamp	Clamp Screw	Clamp Spring	Clamp Screw Wrench	Seat Screw Driver
TCLNL12-3B	CN_33_	LSC32	SO40085I	DLM3	DLS3	DSP3	L-W2.5	DS-T15S
TCLNR12-3B	CN_33_	LSC32	SO40085I	DLM3	DLS3	DSP3	L-W2.5	DS-T15S
TCLNL16-3D	CN_33_	LSC32	SO40085I	DLM3	DLS3	DSP3	L-W2.5	DS-T15S
TCLNR16-3D	CN_33_	LSC32	SO40085I	DLM3	DLS3	DSP3	L-W2.5	DS-T15S
TCLNL12-4B	CN_43_	TSC44	SO40050I	DLM4	DLS4	DSP4	L-W3	DS-T15S
TCLNR12-4B	CN_43_	TSC44	SO40050I	DLM4	DLS4	DSP4	L-W3	DS-T15S
TCLNL16-4D	CN_43_	TSC44	SO40050I	DLM4	DLS4	DSP4	L-W3	DS-T15S
TCLNR16-4D	CN_43_	TSC44	SO40050I	DLM4	DLS4	DSP4	L-W3	DS-T15S
TCLNL20-4D	CN_43_	TSC44	SO40050I	DLM4	DLS4	DSP4	L-W3	DS-T15S
TCLNR20-4D	CN_43_	TSC44	SO40050I	DLM4	DLS4	DSP4	L-W3	DS-T15S
TCLNL24-4D	CN_43_	TSC44	SO40050I	DLM4	DLS4	DSP4	L-W3	DS-T15S
TCLNR24-4D	CN_43_	TSC44	SO40050I	DLM4	DLS4	DSP4	L-W3	DS-T15S
TCLNL16-5D	CN_54_	TSC54	SM50-122-50	DLM5	DLS5	DSP5	L-W4	T20
TCLNR16-5D	CN_54_	TSC54	SM50-122-50	DLM5	DLS5	DSP5	L-W4	T20
TCLNL20-5D	CN_54_	TSC54	SM50-122-50	DLM5	DLS5	DSP5	L-W4	T20
TCLNR20-5D	CN_54_	TSC54	SM50-122-50	DLM5	DLS5	DSP5	L-W4	T20
TCLNL24-5D	CN_54_	TSC54	SM50-122-50	DLM5	DLS5	DSP5	L-W4	T20
TCLNR24-5D	CN_54_	TSC54	SM50-122-50	DLM5	DLS5	DSP5	L-W4	T20
TCLNL16-6D	CN_64_	LSC63	SO80180I	DLM6	DLS5	DSP5	L-W4	DS-T15S
TCLNR16-6D	CN_64_	LSC63	SO80180I	DLM6	DLS5	DSP5	L-W4	DS-T15S
TCLNL20-6D	CN_64_	LSC63	SO80180I	DLM6	DLS5	DSP5	L-W4	DS-T15S
TCLNR20-6D	CN_64_	LSC63	SO80180I	DLM6	DLS5	DSP5	L-W4	DS-T15S
TCLNL24-6D	CN_64_	LSC63	SO80180I	DLM6	DLS5	DSP5	L-W4	DS-T15S
TCLNR24-6D	CN_64_	LSC63	SO80180I	DLM6	DLS5	DSP5	L-W4	DS-T15S

EXTERNAL TOOL HOLDER WITH T-TYPE CLAMPING SYSTEM FOR 80° CN__ INSERTS

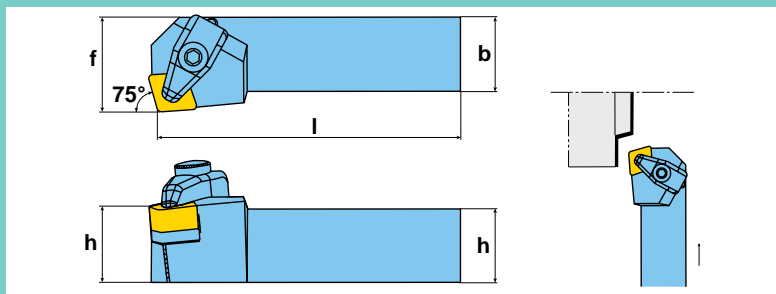

Designation	h	b	l	f
TCMNN12-4B	0.750	0.750	4.500	0.375
TCMNN16-4D	1.000	1.000	6.000	0.500
TCMNN20-6D	1.250	1.250	6.000	0.625

For inserts, see pages 894 - 908, 993, 994, 996, 1009, 1018.

HARDWARE								
	Accepts Insert Series	Seat	Seat Screw	Clamp	Clamp Screw	Clamp Spring	Clamp Screw Wrench	Seat Screw Driver
TCMNN12-4B	CN_43_	TSC44	SO40050I	DLM4	DLS4	DSP4	L-W3	DS-T15S
TCMNN16-4D	CN_43_	TSC44	SO40050I	DLM4	DLS4	DSP4	L-W3	DS-T15S
TCMNN20-6D	CN_64_	LSC63	SO80180I	DLM6	DLS5	DSP5	L-W4	DS-T15S

EXTERNAL TOOL HOLDER WITH T-TYPE CLAMPING SYSTEM FOR 80° CN__ INSERTS

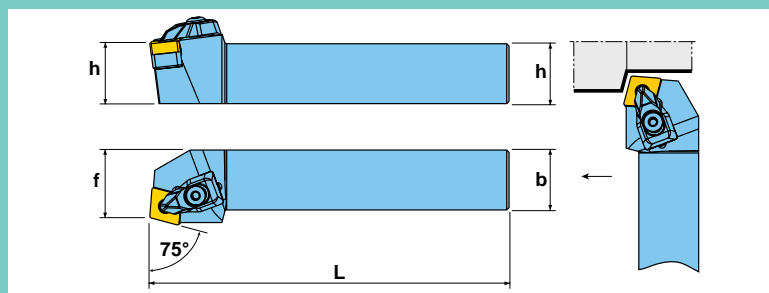

Designation	h	b	l	f
TCRNL12-4B	0.750	0.750	4.500	1.000
TCRNR12-4B	0.750	0.750	4.500	1.000
TCRNL16-4D	1.000	1.000	6.000	1.250
TCRNR16-4D	1.000	1.000	6.000	1.250
TCRNL20-4D	1.250	1.250	6.000	1.500
TCRNR20-4D	1.250	1.250	6.000	1.500

For inserts, see [pages 894 - 908, 993, 994, 996, 1009, 1018](#).

HARDWARE								
	Accepts Insert Series	Seat	Seat Screw	Clamp	Clamp Screw	Clamp Spring	Clamp Screw Wrench	Seat Screw Driver
TCRNL12-4B	CN_43_	TSC44	SO40050I	DLM4	DLS4	DSP4	L-W3	DS-T15S
TCRNR12-4B	CN_43_	TSC44	SO40050I	DLM4	DLS4	DSP4	L-W3	DS-T15S
TCRNL16-4D	CN_43_	TSC44	SO40050I	DLM4	DLS4	DSP4	L-W3	DS-T15S
TCRNR16-4D	CN_43_	TSC44	SO40050I	DLM4	DLS4	DSP4	L-W3	DS-T15S
TCRNL20-4D	CN_43_	TSC44	SO40050I	DLM4	DLS4	DSP4	L-W3	DS-T15S
TCRNR20-4D	CN_43_	TSC44	SO40050I	DLM4	DLS4	DSP4	L-W3	DS-T15S

EXTERNAL TOOL HOLDER WITH T-TYPE CLAMPING SYSTEM FOR 55° DN__ INSERTS

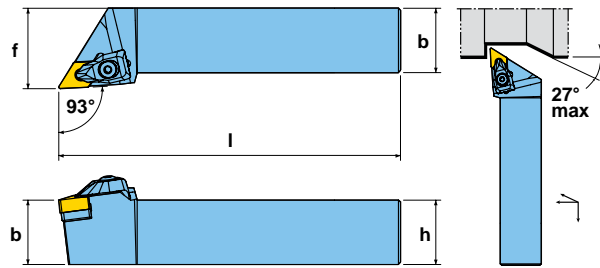

Designation	h	b	l	f
TDJNL12-3B	0.750	0.750	4.500	1.000
TDJNR12-3B	0.750	0.750	4.500	1.000
TDJNL16-3D	1.000	1.000	4.500	1.250
TDJNR16-3D	1.000	1.000	4.500	1.250
TDJNL12-4B	0.750	0.750	4.500	1.000
TDJNR12-4B	0.750	0.750	4.500	1.000
TDJNL16-4D	1.000	1.000	6.000	1.250
TDJNR16-4D	1.000	1.000	6.000	1.250
TDJNL20-4D	1.250	1.250	6.000	1.500
TDJNR20-4D	1.250	1.250	6.000	1.500
TDJNL12-44B	0.750	0.750	4.500	1.250
TDJNR12-44B	0.750	0.750	4.500	1.250
TDJNL16-44D	1.000	1.000	6.000	1.500
TDJNR16-44D	1.000	1.000	6.000	1.500

For inserts, see [pages 909 - 919, 997, 998, 1011, 1019](#).

HARDWARE								
	Accepts Insert Series	Seat	Seat Screw	Clamp	Clamp Screw	Clamp Spring	Clamp Screw Wrench	Seat Screw Driver
TDJNL12-3B	DN__33__	LSD32	SO40085I	DLM3	DLS3	DSP3	L-W2.5	DS-T15S
TDJNR12-3B	DN__33__	LSD32	SO40085I	DLM3	DLS3	DSP3	L-W2.5	T20
TDJNL16-3D	DN__33__	LSD32	SO40085I	DLM3	DLS3	DSP3	L-W2.5	DS-T15S
TDJNR16-3D	DN__33__	LSD32	SO40085I	DLM3	DLS3	DSP3	L-W2.5	DS-T15S
TDJNL12-4B	DN__43__	TSD44	SO40050I	DLM4	DLS4	DSP4	L-W3	DS-T15S
TDJNR12-4B	DN__43__	TSD44	SO40050I	DLM4	DLS4	DSP4	L-W3	DS-T15S
TDJNL16-4D	DN__43__	TSD44	SO40050I	DLM4	DLS4	DSP4	L-W3	DS-T15S
TDJNR16-4D	DN__43__	TSD44	SO40050I	DLM4	DLS4	DSP4	L-W3	DS-T15S
TDJNL20-4D	DN__43__	TSD44	SO40050I	DLM4	DLS4	DSP4	L-W3	DS-T15S
TDJNR20-4D	DN__43__	TSD44	SO40050I	DLM4	DLS4	DSP4	L-W3	DS-T15S
TDJNL12-44B	DN__44__	TSD43	SM50-122-50	DLM4	DLS4	DSP4	L-W3	T20
TDJNR12-44B	DN__44__	TSD43	SM50-122-50	DLM4	DLS4	DSP4	L-W3	T20
TDJNL16-44D	DN__44__	TSD43	SM50-122-50	DLM4	DLS4	DSP4	L-W3	T20
TDJNR16-44D	DN__44__	TSD43	SM50-122-50	DLM4	DLS4	DSP4	L-W3	DS-T15S

TOTURN™ TDNNN

EXTERNAL TOOL HOLDER WITH T-TYPE CLAMPING SYSTEM FOR 55° DN__ INSERTS

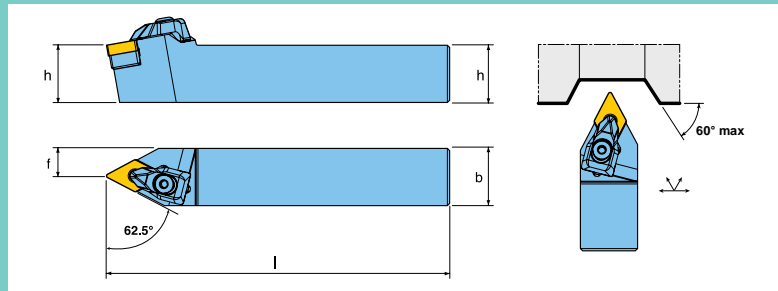
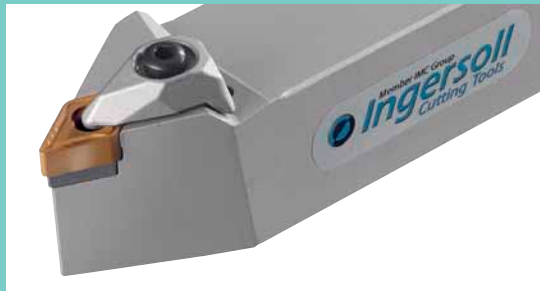

Designation	h	b	l	f
TDNNN16-4D	1.000	1.000	6.000	0.500

For inserts, see [pages 909 - 919, 997, 998, 1011, 1019](#).

HARDWARE								
	Accepts Insert Series	Seat	Seat Screw	Clamp	Clamp Screw	Clamp Spring	Clamp Screw Wrench	Seat Screw Driver
TDNNN16-4D	DN__43__	TSD44	SO40050I	DLM4	DLS4	DSP4	L-W3	DS-T15S

TOTURN™ TDQNR/L

EXTERNAL TOOL HOLDER WITH T-TYPE CLAMPING SYSTEM FOR 55° DN__ INSERTS

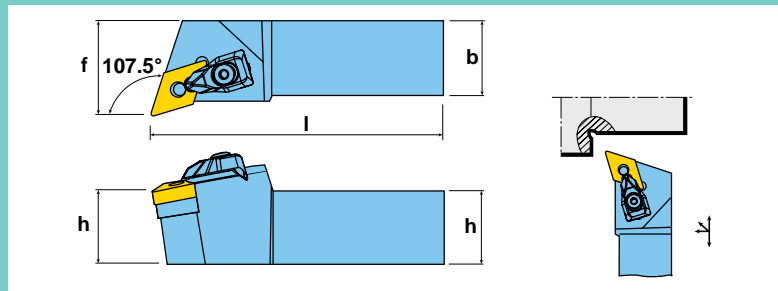

Designation	h	b	l	f
TDQNL16-4D	1.000	1.000	6.000	1.250
TDQNR16-4D	1.000	1.000	6.000	1.250

For inserts, see [pages 909 - 919, 997, 998, 1011, 1019](#).

HARDWARE								
	Accepts Insert Series	Seat	Seat Screw	Clamp	Clamp Screw	Clamp Spring	Clamp Screw Wrench	Seat Screw Driver
TDQNL16-4D	DN__43__	TSD44	SO40050I	DLM4	DLS4	DSP4	L-W3	DS-T15S
TDQNR16-4D	DN__43__	TSD44	SO40050I	DLM4	DLS4	DSP4	L-W3	DS-T15S

EXTERNAL TOOL HOLDER WITH T-TYPE CLAMPING SYSTEM FOR 120° HN__ INSERTS

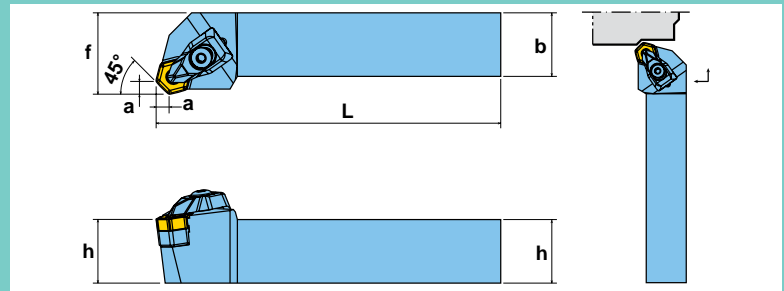

Designation	h	b	l	f
THSNL12-4B	0.750	0.750	4.500	1.000
THSNR12-4B	0.750	0.750	4.500	1.000
THSNL16-4D	1.000	1.000	6.000	1.250
THSNR16-4D	1.000	1.000	6.000	1.250
THSNL20-4D	1.250	1.250	6.000	1.570
THSNR20-4D	1.250	1.250	6.000	1.570
THSNL16-6D	1.000	1.000	6.000	1.250
THSNR16-6D	1.000	1.000	6.000	1.250
THSNL20-6D	1.250	1.250	6.000	1.500
THSNR20-6D	1.250	1.250	6.000	1.500
THSNL24-6E	1.500	1.500	7.000	2.000
THSNR24-6E	1.500	1.500	7.000	2.000

For inserts, [pages 919, 920](#).

HARDWARE								
	Accepts Insert Series	Seat	Seat Screw	Clamp	Clamp Screw	Clamp Spring	Clamp Screw Wrench	Seat Screw Driver
THSNL12-4B	HN_43_	TSH44	SO40050I	DLM4	DLS4	DSP4	L-W3	DS-T15S
THSNR12-4B	HN_43_	TSH44	SO40050I	DLM4	DLS4	DSP4	L-W3	DS-T15S
THSNL16-4D	HN_43_	TSH44	SO40050I	DLM4	DLS4	DSP4	L-W3	DS-T15S
THSNR16-4D	HN_43_	TSH44	SO40050I	DLM4	DLS4	DSP4	L-W3	DS-T15S
THSNL20-4D	HN_43_	TSH44	SO40050I	DLM4	DLS4	DSP4	L-W3	DS-T15S
THSNR20-4D	HN_43_	TSH44	SO40050I	DLM4	DLS4	DSP4	L-W3	DS-T15S
THSNL16-6D	HN_64_	TSH64	SM50-122-50	DLM6	DLS5	DSP5	L-W4	T20
THSNR16-6D	HN_64_	TSH64	SM50-122-50	DLM6	DLS5	DSP5	L-W4	T20
THSNL20-6D	HN_64_	TSH64	SM50-122-50	DLM6	DLS5	DSP5	L-W4	T20
THSNR20-6D	HN_64_	TSH64	SM50-122-50	DLM6	DLS5	DSP5	L-W4	T20
THSNL24-6E	HN_64_	TSH64	SM50-122-50	DLM6	DLS5	DSP5	L-W4	T20
THSNR24-6E	HN_64_	TSH64	SM50-122-50	DLM6	DLS5	DSP5	L-W4	T20

TOTURN™ THSN QUICK-CHANGE*

EXTERNAL TOOL HOLDER WITH T-TYPE CLAMPING SYSTEM FOR 120° HN__ INSERTS

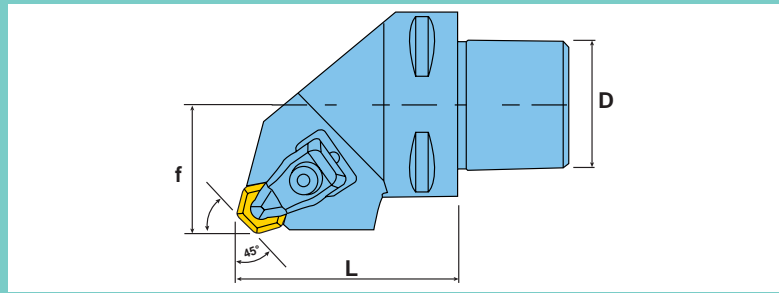

Designation	D (mm)	l	f
C4-THSNR27050-05	40.000	1.969	1.063
C5-THSNR35060-05	50.000	2.362	1.378
C6-THSNL55065-10	60.000	2.559	2.165
C6-THSNR55065-10	60.000	2.559	2.165

*Coromant CAPTO connection. CAPTO is a registered trademark of Sandvik AB.
For inserts, pages 919, 920.

HARDWARE									
	Accepts Insert Series	Seat	Seat Screw	Clamp	Clamp Screw	Clamp Spring	Clamp Screw Wrench	Coolant Nozzle	Seat Screw Driver
C4-THSNR27050-05	HN__43_	TSH44	SO40050I	DLM4	DLS4	DSP4	L-W3	NZ62	DS-T15S
C5-THSNR35060-05	HN__43_	TSH44	SO40050I	DLM4	DLS4	DSP4	L-W3	NZ104	DS-T15S
C6-THSNL55065-10	HN__64_	TSH64	SM50-122-50	DLM6	DLS5	DSP5	L-W4	NZ104	T20
C6-THSNR55065-10	HN__64_	TSH64	SM50-122-50	DLM6	DLS5	DSP5	L-W4	NZ104	T20

EXTERNAL TOOL HOLDER WITH T-TYPE CLAMPING SYSTEM FOR 90° SN__ INSERTS

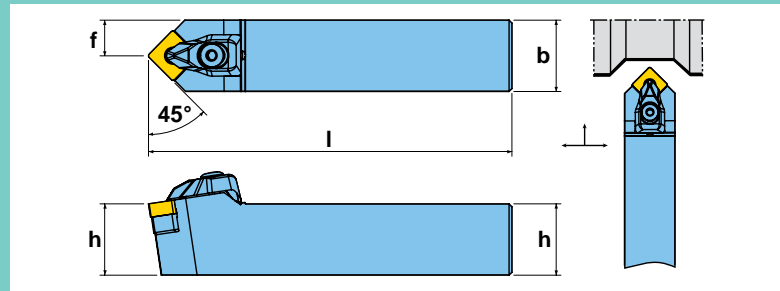

Designation	h	b	l	f
TSDNN12-4B	0.750	0.750	4.500	0.375
TSDNN16-4D	1.000	1.000	6.000	0.500
TSDNN20-4D	1.250	1.250	6.000	0.625
TSDNN20-6D	1.250	1.250	6.000	0.625

For inserts, see [pages 922 - 931, 1000, 1002, 1013, 1020](#).





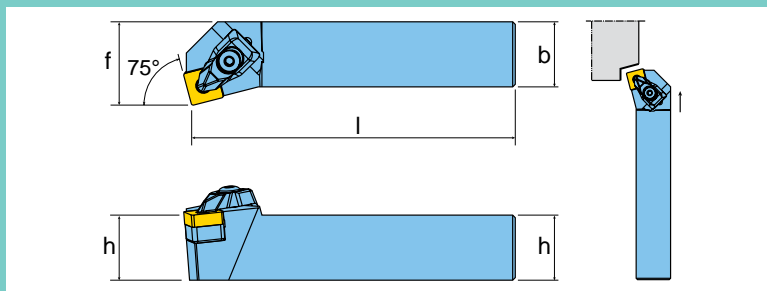



HARDWARE								
	Accepts Insert Series	Seat	Seat Screw	Clamp	Clamp Screw	Clamp Spring	Clamp Screw Wrench	Seat Screw Driver
TSDNN12-4B	SN_43_	TSS44	SO40050I	DLM4	DLS4	DSP4	L-W3	DS-T15S
TSDNN16-4D	SN_43_	TSS44	SO40050I	DLM4	DLS4	DSP4	L-W3	DS-T15S
TSDNN20-4D	SN_43_	TSS44	SO40050I	DLM4	DLS4	DSP4	L-W3	DS-T15S
TSDNN20-6D	SN_64_	LSS63	SO80180I	DLM6	DLS5	DSP5	L-W4	DS-T15S

EXTERNAL TOOL HOLDER WITH T-TYPE CLAMPING SYSTEM FOR 90° SN__ INSERTS



Designation	h	b	l	f
TSKNL16-4D	1.000	1.000	6.000	1.250
TSKNR16-4D	1.000	1.000	6.000	1.250

For inserts, see [pages 922 - 931, 1000, 1002, 1013, 1020](#).

HARDWARE								
	Accepts Insert Series	Seat	Seat Screw	Clamp	Clamp Screw	Clamp Spring	Clamp Screw Wrench	Seat Screw Driver
TSKNL16-4D	SN_43_	TSS44	SO40050I	DLM4	DLS4	DSP4	L-W3	DS-T15S
TSKNR16-4D	SN_43_	TSS44	SO40050I	DLM4	DLS4	DSP4	L-W3	DS-T15S

EXTERNAL TOOL HOLDER WITH T-TYPE CLAMPING SYSTEM FOR 90° SN__ INSERTS

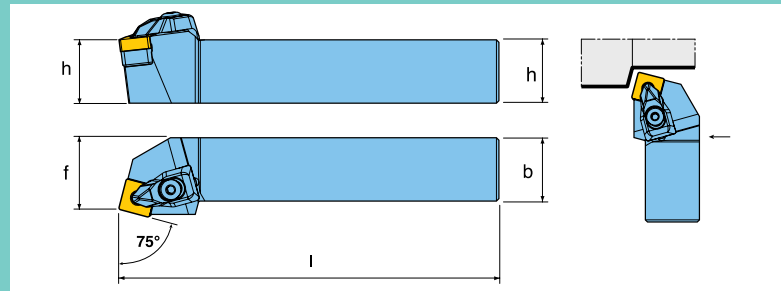

Designation	h	b	l	f
TSRNL16-4D	1.000	1.000	6.000	1.130
TSRNR16-4D	1.000	1.000	6.000	1.130
TSRNL20-4D	1.250	1.250	6.000	1.380
TSRNR20-4D	1.250	1.250	6.000	1.380
TSRNL20-5D	1.250	1.250	6.000	1.353
TSRNR20-5D	1.250	1.250	6.000	1.353
TSRNL20-6D	1.250	1.250	6.000	1.321
TSRNR20-6D	1.250	1.250	6.000	1.321

For inserts, see [pages 922 - 931](#), [1000](#), [1002](#), [1013](#), [1020](#).

HARDWARE								
	Accepts Insert Series	Seat	Seat Screw	Clamp	Clamp Screw	Clamp Spring	Clamp Screw Wrench	Seat Screw Driver
TSRNL16-4D	SN_43_	TSS44	SO40050I	DLM4	DLS4	DSP4	L-W3	DS-T15S
TSRNR16-4D	SN_43_	TSS44	SO40050I	DLM4	DLS4	DSP4	L-W3	DS-T15S
TSRNL20-4D	SN_43_	TSS44	SO40050I	DLM4	DLS4	DSP4	L-W3	DS-T15S
TSRNR20-4D	SN_43_	TSS44	SO40050I	DLM4	DLS4	DSP4	L-W3	DS-T15S
TSRNL20-5D	SN_54_	TSS54	SM50-122-50	DLM5	DLS5	DSP5	L-W4	DS-T15S
TSRNR20-5D	SN_54_	TSS54	SM50-122-50	DLM5	DLS5	DSP5	L-W4	DS-T15S
TSRNL20-6D	SN_64_	LSS63	SO80180I	DLM6	DLS5	DSP5	L-W4	DS-T15S
TSRNR20-6D	SN_64_	LSS63	SO80180I	DLM6	DLS5	DSP5	L-W4	DS-T15S

EXTERNAL TOOL HOLDER WITH T-TYPE CLAMPING SYSTEM FOR 90° SN__ INSERTS

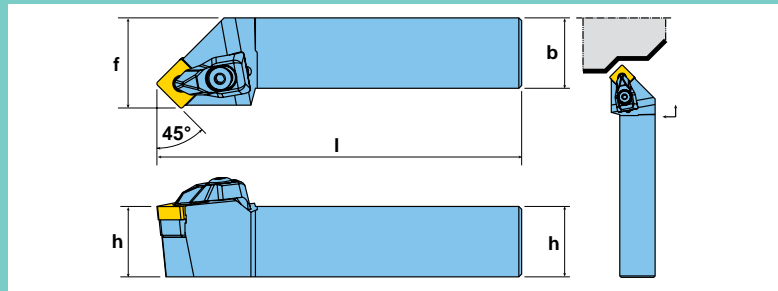

Designation	h	b	l	f
TSSNL16-4D	1.000	1.000	6.000	0.921
TSSNR16-4D	1.000	1.000	6.000	0.921
TSSNL20-6D	1.250	1.250	6.000	1.010
TSSNR20-6D	1.250	1.250	6.000	1.010

For inserts, see pages 922 - 931, 1000, 1002, 1013, 1020.

HARDWARE								
	Accepts Insert Series	Seat	Seat Screw	Clamp	Clamp Screw	Clamp Spring	Clamp Screw Wrench	Seat Screw Driver
TSSNL16-4D	SN__43__	TSS44	SO40050I	DLM4	DLS4	DSP4	L-W3	DS-T15S
TSSNR16-4D	SN__43__	TSS44	SO40050I	DLM4	DLS4	DSP4	L-W3	DS-T15S
TSSNL20-6D	SN__64__	LSS63	SO80180I	DLM6	DLS5	DSP5	L-W4	DS-T15S
TSSNR20-6D	SN__64__	LSS63	SO80180I	DLM6	DLS5	DSP5	L-W4	DS-T15S

EXTERNAL TOOL HOLDER WITH T-TYPE CLAMPING SYSTEM FOR 60° TN__ INSERTS

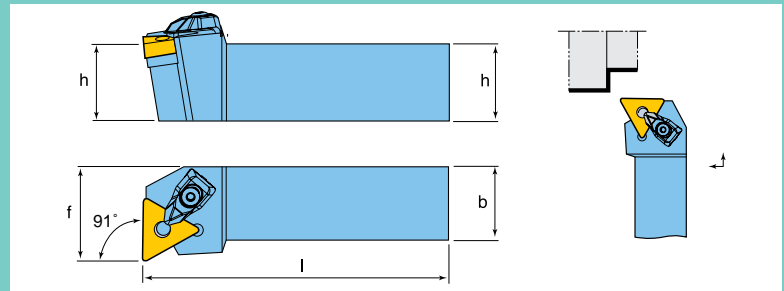

Designation	h	b	l	f
TTFNL12-3B	0.750	0.750	4.500	1.000
TTFNR12-3B	0.750	0.750	4.500	1.000
TTFNL16-3D	1.000	1.000	6.000	1.250
TTFNR16-3D	1.000	1.000	6.000	1.250
TTFNL16-4D	1.000	1.000	6.000	1.250
TTFNR16-4D	1.000	1.000	6.000	1.250

For inserts, see [pages 932 - 944, 1003, 1004, 1015, 1021](#).

HARDWARE								
	Accepts Insert Series	Seat	Seat Screw	Clamp	Clamp Screw	Clamp Spring	Clamp Screw Wrench	Seat Screw Driver
TTFNL12-3B	TN__33__	TST33	S035080I	DLM3	DLS3	DSP3	L-W2.5	DS-T15S
TTFNR12-3B	TN__33__	TST33	S035080I	DLM3	DLS3	DSP3	L-W2.5	DS-T15S
TTFNL16-3D	TN__33__	TST33	S035080I	DLM3	DLS3	DSP3	L-W2.5	DS-T15S
TTFNR16-3D	TN__33__	TST33	S035080I	DLM3	DLS3	DSP3	L-W2.5	DS-T15S
TTFNL16-4D	TT__43__	TST43	S040050I	DLM4	DLS4	DSP4	L-W3	DS-T15S
TTFNR16-4D	TT__43__	TST43	S040050I	DLM4	DLS4	DSP4	L-W3	DS-T15S

EXTERNAL TOOL HOLDER WITH T-TYPE CLAMPING SYSTEM FOR 60° TN__ INSERTS

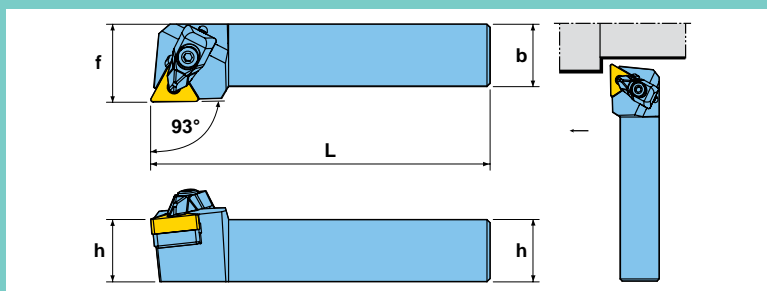

Designation	h	b	l	f
TTJNL12-3B	0.075	0.075	4.500	1.000
TTJNR12-3B	0.075	0.075	4.500	1.000
TTJNL16-3D	1.000	1.000	6.000	1.250
TTJNR16-3D	1.000	1.000	6.000	1.250
TTJNL16-4D	1.000	1.000	6.000	1.250
TTJNR16-4D	1.000	1.000	6.000	1.250
TTJNL20-4D	1.250	1.250	6.000	1.516
TTJNR20-4D	1.250	1.250	6.000	1.516

For inserts, see [pages 932 - 944, 1003, 1004, 1015, 1021](#).

HARDWARE								
	Accepts Insert Series	Seat	Seat Screw	Clamp	Clamp Screw	Clamp Spring	Clamp Screw Wrench	Seat Screw Driver
TTJNL12-3B	TN__33__	TST33	SO35080I	DLM3	DLS3	DSP3	L-W2.5	DS-T15S
TTJNR12-3B	TN__33__	TST33	SO35080I	DLM3	DLS3	DSP3	L-W2.5	DS-T15S
TTJNL16-3D	TN__33__	TST33	SO35080I	DLM3	DLS3	DSP3	L-W2.5	DS-T15S
TTJNR16-3D	TN__33__	TST33	SO35080I	DLM3	DLS3	DSP3	L-W2.5	DS-T15S
TTJNL16-4D	TT__43__	TST43	SO40050I	DLM4	DLS4	DSP4	L-W3	DS-T15S
TTJNR16-4D	TT__43__	TST43	SO40050I	DLM4	DLS4	DSP4	L-W3	DS-T15S
TTJNL20-4D	TT__43__	TST43	SO40050I	DLM4	DLS4	DSP4	L-W3	DS-T15S
TTJNR20-4D	TT__43__	TST43	SO40050I	DLM4	DLS4	DSP4	L-W3	DS-T15S

EXTERNAL TOOL HOLDER WITH T-TYPE CLAMPING SYSTEM FOR 35° VN__ INSERTS

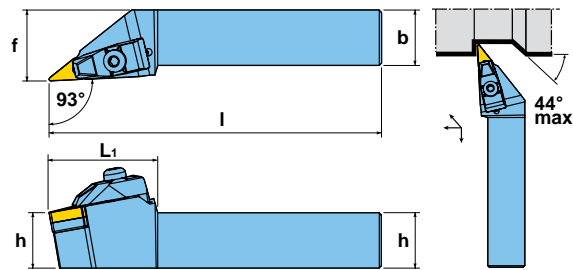

Designation	h	b	l	f
TVJNL12-3C	0.750	0.750	5.000	1.000
TVJNR12-3C	0.750	0.750	5.000	1.000
TVJNL16-3D	1.000	1.000	6.000	1.250
TVJNR16-3D	1.000	1.000	6.000	1.250
TVJNL20-3D	1.250	1.250	6.000	1.500
TVJNR20-3D	1.250	1.250	6.000	1.500

For inserts, see [pages 944 - 949](#), [1005](#), [1016](#), [1023](#).

HARDWARE								
	Accepts Insert Series	Seat	Seat Screw	Clamp	Clamp Screw	Clamp Spring	Clamp Screw Wrench	Seat Screw Driver
TVJNL12-3C	VN__33__	TSV33	S035080I	DLM3-V16	DLS5	DSP5	L-W4	DS-T15S
TVJNR12-3C	VN__33__	TSV33	S035080I	DLM3-V16	DLS5	DSP5	L-W4	DS-T15S
TVJNL16-3D	VN__33__	TSV33	S035080I	DLM3-V16	DLS5	DSP5	L-W4	DS-T15S
TVJNR16-3D	VN__33__	TSV33	S035080I	DLM3-V16	DLS5	DSP5	L-W4	DS-T15S
TVJNL20-3D	VN__33__	TSV33	S035080I	DLM3-V16	DLS5	DSP5	L-W4	DS-T15S
TVJNR20-3D	VN__33__	TSV33	S035080I	DLM3-V16	DLS5	DSP5	L-W4	DS-T15S

TOTURN™ TVQNR/L

EXTERNAL TOOL HOLDER WITH T-TYPE CLAMPING SYSTEM FOR 35° VN__ INSERTS

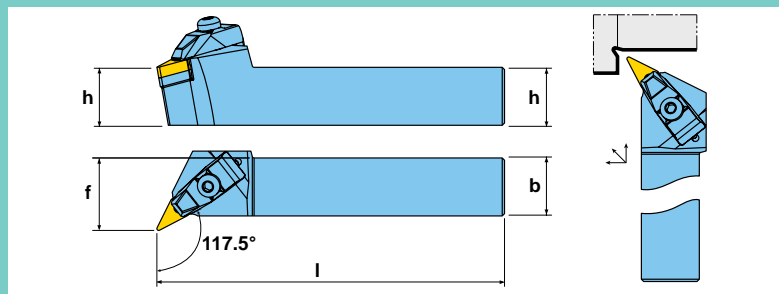

Designation	h	b	l	f
TVQNL16-3D	1.000	1.000	6.000	1.250
TVQNR16-3D	1.000	1.000	6.000	1.250

For inserts, see pages 944 - 949, 1005, 1016, 1023.

HARDWARE								
	Accepts Insert Series	Seat	Seat Screw	Clamp	Clamp Screw	Clamp Spring	Clamp Screw Wrench	Seat Screw Driver
TVQNL16-3D	VN__33__	TSV33	SO35080I	DLM3-V16	DLS5	DSP5	L-W4	DS-T155
TVQNR16-3D	VN__33__	TSV33	SO35080I	DLM3-V16	DLS5	DSP5	L-W4	DS-T155

TOTURN™ TVVNN

EXTERNAL TOOL HOLDER WITH T-TYPE CLAMPING SYSTEM FOR 35° VN__ INSERTS

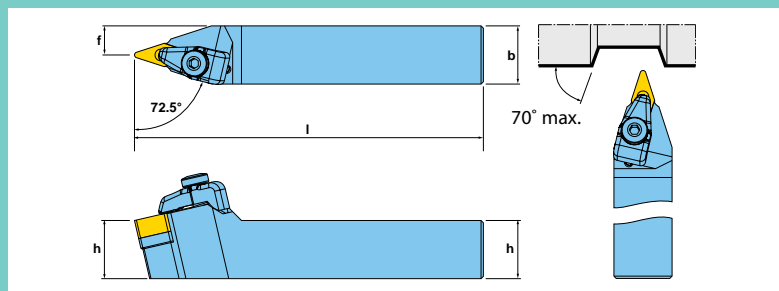

Designation	h	b	l	f
TVVNN12-3B	0.750	0.750	4.500	0.375
TVVNN16-3D	1.000	1.000	6.000	0.500

For inserts, see pages 944 - 949, 1005, 1016, 1023.

HARDWARE								
	Accepts Insert Series	Seat	Seat Screw	Clamp	Clamp Screw	Clamp Spring	Clamp Screw Wrench	Seat Screw Driver
TVVNN12-3B	VN__33__	TSV33	SO35080I	DLM3-V16	DLS5	DSP5	L-W4	DS-T155
TVVNN16-3D	VN__33__	TSV33	SO35080I	DLM3-V16	DLS5	DSP5	L-W4	DS-T155

EXTERNAL TOOL HOLDER WITH T-TYPE CLAMPING SYSTEM FOR TRIGON WN__ INSERTS

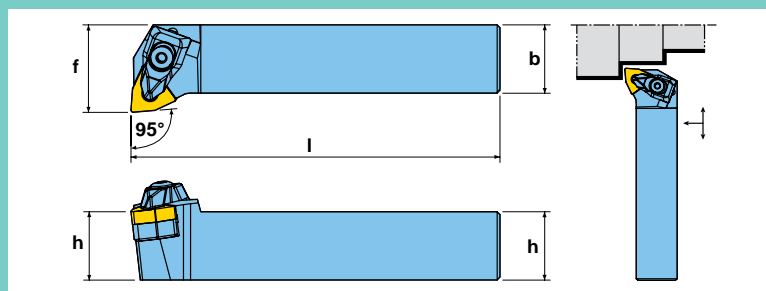

Designation	h	b	l	f
TWLNL10-3A	0.625	0.625	4.000	1.000
TWLNLR10-3A	0.625	0.625	4.000	1.000
TWLNL12-3B	0.750	0.750	4.500	1.000
TWLNLR12-3B	0.750	0.750	4.500	1.000
TWLNL16-3D	1.000	1.000	6.000	1.250
TWLNLR16-3D	1.000	1.000	6.000	1.250
TWLNL12-4B	0.750	0.750	4.500	1.000
TWLNLR12-4B	0.750	0.750	4.500	1.000
TWLNL16-4D	1.000	1.000	6.000	1.250
TWLNLR16-4D	1.000	1.000	6.000	1.250
TWLNL20-4D	1.250	1.250	6.000	1.500
TWLNLR20-4D	1.250	1.250	6.000	1.500

For inserts, see [pages 950 - 960, 1006, 1007, 1017](#).

HARDWARE								
	Accepts Insert Series	Seat	Seat Screw	Clamp	Clamp Screw	Clamp Spring	Clamp Screw Wrench	Seat Screw Driver
TWLNL10-3A	WN_33_	PSW32	SO40090I	DLM3	DLS3	DSP3	L-W2.5	DS-T15S
TWLNLR10-3A	WN_33_	PSW32	SO40090I	DLM3	DLS3	DSP3	L-W2.5	DS-T15S
TWLNL12-3B	WN_33_	PSW32	SO40090I	DLM3	DLS3	DSP3	L-W2.5	DS-T15S
TWLNLR12-3B	WN_33_	PSW32	SO40090I	DLM3	DLS3	DSP3	L-W2.5	DS-T15S
TWLNL16-3D	WN_33_	PSW32	SO40090I	DLM3	DLS3	DSP3	L-W2.5	DS-T15S
TWLNLR16-3D	WN_33_	PSW32	SO40090I	DLM3	DLS3	DSP3	L-W2.5	DS-T15S
TWLNL12-4B	WN_43_	TSW44	SO40050I	DLM4	DLS4	DSP4	L-W3	DS-T15S
TWLNLR12-4B	WN_43_	TSW44	SO40050I	DLM4	DLS4	DSP4	L-W3	DS-T15S
TWLNL16-4D	WN_43_	TSW44	SO40050I	DLM4	DLS4	DSP4	L-W3	DS-T15S
TWLNLR16-4D	WN_43_	TSW44	SO40050I	DLM4	DLS4	DSP4	L-W3	DS-T15S
TWLNL20-4D	WN_43_	TSW44	SO40050I	DLM4	DLS4	DSP4	L-W3	DS-T15S
TWLNLR20-4D	WN_43_	TSW44	SO40050I	DLM4	DLS4	DSP4	L-W3	DS-T15S

EXTERNAL TOOL HOLDER WITH WEDGE TYPE CLAMPING SYSTEM FOR 80° TN__ INSERTS

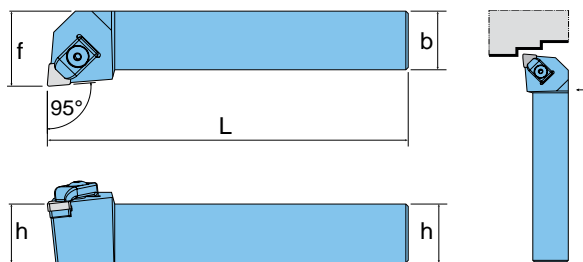

Designation	h	b	l	f
CCLNL12-4BCEA	0.750	0.750	4.500	1.000
CCLNR16-4DCEA	1.000	1.000	6.000	1.250
CCLNL12-4BCE	0.750	0.750	4.500	1.000
CCLNR12-4BCE	0.750	0.750	4.500	1.000
CCLNR16-4DCE	1.000	1.000	6.000	1.250

For inserts, see [page 995](#).





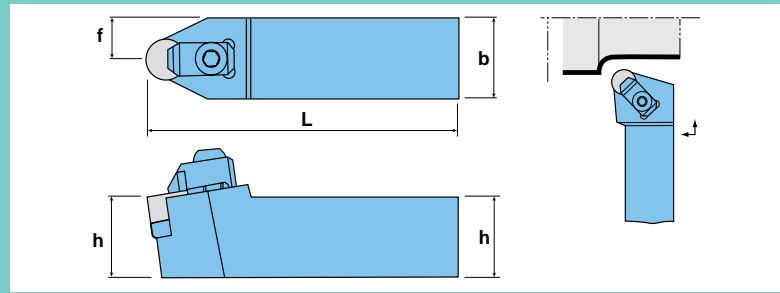

HARDWARE							
	Accepts Insert Series	Seat	Seat Screw	Clamp	Clamp Screw	Seat Screw Wrench	Clamp Screw Wrench
CCLNL12-4BCEA	CNG_43_	S48	BHM5X0.8X10	BCL6	BHM6X1X20	L-W3	L-W4
CCLNR16-4DCEA	CNG_43_	S48	BHM5X0.8X10	BCL6	BHM6X1X20	L-W3	L-W4
CCLNL12-4BCE	CNG_45_	S48	BHM5X0.8X10	BCL6	BHM6X1X20	L-W3	L-W4
CCLNR12-4BCE	CNG_45_	S48	BHM5X0.8X10	BCL6	BHM6X1X20	L-W3	L-W4
CCLNR16-4DCE	CNG_45_	S48	BHM5X0.8X10	BCL6	BHM6X1X20	L-W3	L-W4

EXTERNAL TOOL HOLDER WITH T-TYPE CLAMPING SYSTEM FOR CERAMIC INSERTS



Designation	h	b	l	f
CRDNN12-4BCE	0.750	0.750	4.500	0.375
CRDNN12-4BCEA	0.750	0.750	4.500	0.375
CRDNN16-4DCE	1.000	1.000	6.000	0.500
CRDNN16-4DCEA	1.000	1.000	6.000	0.500

For inserts, see [page 999](#).

HARDWARE							
	Accepts Insert Series	Seat	Seat Screw	Clamp	Clamp Screw	Seat Screw Wrench	Clamp Screw Wrench
CRDNN12-4BCE	RNG45	S43	BHM5X0.8X8	BCL6	BHM6X1X20	L-W3	L-W4
CRDNN12-4BCEA	RNG43	S43	BHM5X0.8X8	BCL6	BHM6X1X20	L-W3	L-W4
CRDNN16-4DCE	RNG45	S43	BHM5X0.8X10	BCL6	BHM6X1X20	L-W3	L-W4
CRDNN16-4DCEA	RNG43	S43	BHM5X0.8X10	BCL6	BHM6X1X20	L-W3	L-W4

EXTERNAL TOOL HOLDER WITH T-TYPE CLAMPING SYSTEM FOR CERAMIC INSERTS

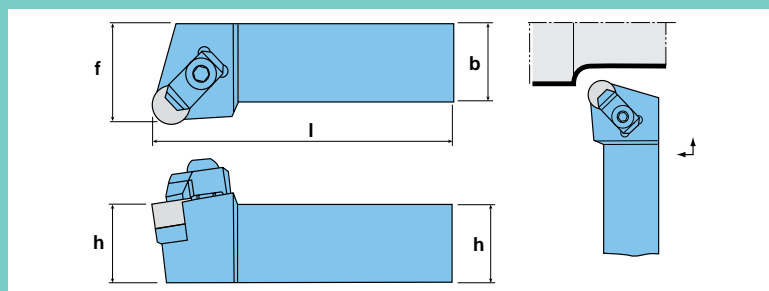

Designation	h	b	l	f
CRGNR12-4BCEA	0.750	0.750	4.500	1.000
CRGNL16-4DCE	1.000	1.000	6.000	1.250
CRGNR16-4DCE	1.000	1.000	6.000	1.250
CRGNL16-4DCEA	1.000	1.000	6.000	1.250
CRGNR16-4DCEA	1.000	1.000	6.000	1.250
CRGNL20-4ECE	1.250	1.250	7.000	1.500
CRGNR20-4ECE	1.250	1.250	7.000	1.500

For inserts, see [page 999](#).





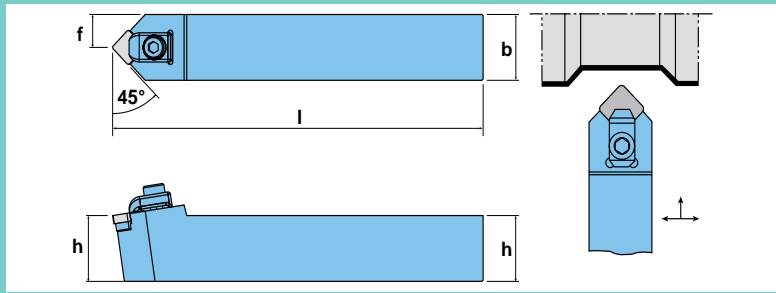

HARDWARE							
	Accepts Insert Series	Seat	Seat Screw	Clamp	Clamp Screw	Seat Screw Wrench	Clamp Screw Wrench
CRGNR12-4BCEA	RNG43	S43	BHM5X0.8X10	BCL6	BHM6X1X20	L-W3	L-W4
CRGNL16-4DCE	RNG45	S43	BHM5X0.8X10	BCL6	BHM6X1X20	L-W3	L-W4
CRGNR16-4DCE	RNG45	S43	BHM5X0.8X10	BCL6	BHM6X1X20	L-W3	L-W4
CRGNL16-4DCEA	RNG43	S43	BHM5X0.8X10	BCL6	BHM6X1X20	L-W3	L-W4
CRGNR16-4DCEA	RNG43	S43	BHM5X0.8X10	BCL6	BHM6X1X20	L-W3	L-W4
CRGNL20-4ECE	RNG45	S43	BHM5X0.8X10	BCL6	BHM6X1X20	L-W3	L-W4
CRGNR20-4ECE	RNG45	S43	BHM5X0.8X10	BCL6	BHM6X1X20	L-W3	L-W4

EXTERNAL TOOL HOLDER WITH T-TYPE CLAMPING SYSTEM FOR CERAMIC INSERTS



Designation	h	b	l	f
CSDNN12-4BCEA	0.750	0.750	4.500	0.375
CSDNN16-4CE	1.000	1.000	6.000	0.500
CSDNN16-4DCEA	1.000	1.000	6.000	0.500
CSDNN20-4ECE	1.250	1.250	7.000	0.625

For inserts, see [pages 1001, 1013, 1014](#).





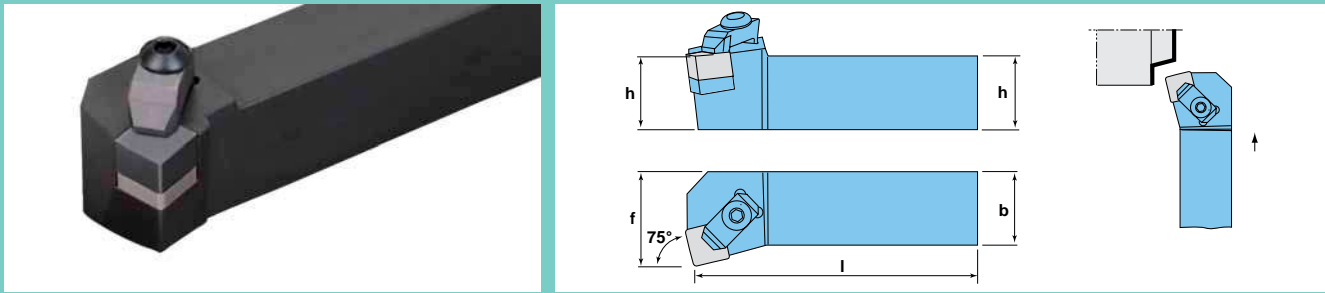

HARDWARE							
	Accepts Insert Series	Seat	Seat Screw	Clamp	Clamp Screw	Seat Screw Wrench	Clamp Screw Wrench
CSDNN12-4BCEA	SNG43_	S40	BHM5X0.8X10	BCL6	BHM6X1X20	L-W3	L-W4
CSDNN16-4CE	SNG45_	S40	BHM5X0.8X10	BCL6	BHM6X1X20	L-W3	L-W4
CSDNN16-4DCEA	SNG43_	S40	BHM5X0.8X10	BCL6	BHM6X1X20	L-W3	L-W4
CSDNN20-4ECE	SNG45_	S40	BHM5X0.8X10	BCL6	BHM6X1X20	L-W3	L-W4

EXTERNAL TOOL HOLDER WITH T-TYPE CLAMPING SYSTEM FOR CERAMIC INSERTS



Designation	h	b	l	f
CSKNL16-4DCE	1.000	1.000	6.000	1.250
CSKNR16-4DCE	1.000	1.000	6.000	1.250
CSKNR16-4DCEA	1.000	1.000	6.000	1.250

For inserts, see [pages 1001, 1013, 1014](#).





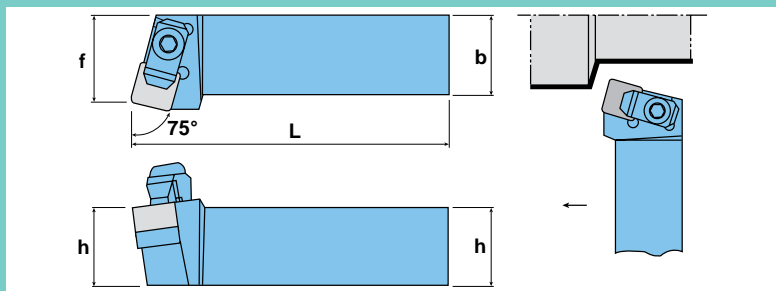

HARDWARE							
	Accepts Insert Series	Seat	Seat Screw	Clamp	Clamp Screw	Seat Screw Wrench	Clamp Screw Wrench
CSKNL16-4DCE	SNG45_	S40	BHM5X0.8X10	BCL6	BHM6X1X20	L-W3	L-W4
CSKNR16-4DCE	SNG45_	S40	BHM5X0.8X10	BCL6	BHM6X1X20	L-W3	L-W4
CSKNR16-4DCEA	SNG43_	S40	BHM5X0.8X10	BCL6	BHM 6X1X20	L-W3	L-W4

EXTERNAL TOOL HOLDER WITH T-TYPE CLAMPING SYSTEM FOR CERAMIC INSERTS



Designation	h	b	l	f
CSRNR16-4DCEA	1.000	1.000	6.000	1.063
CSRNR20-4CE	1.250	1.250	7.000	1.313

For inserts, see pages 1001, 1013, 1014.





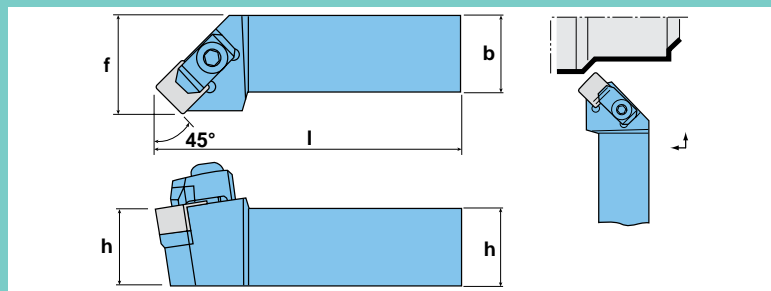

HARDWARE							
	Accepts Insert Series	Seat	Seat Screw	Clamp	Clamp Screw	Seat Screw Wrench	Clamp Screw Wrench
CSRNR16-4DCEA	SNG43_	S40	BHM5X0.8X10	BCL6	BHM6X1X20	L-W3	L-W4
CSRNR20-4CE	SNG45_	S40	BHM5X0.8X10	BCL6	BHM6X1X20	L-W3	L-W4

EXTERNAL TOOL HOLDER WITH T-TYPE CLAMPING SYSTEM FOR CERAMIC INSERTS



Designation	h	b	l	f
CSSNR16-4DCEA	1.000	1.000	6.000	1.250

For inserts, see [pages 1001, 1013, 1014](#).

HARDWARE							
	Accepts Insert Series	Seat	Seat Screw	Clamp	Clamp Screw	Seat Screw Wrench	Clamp Screw Wrench
	SNG43_	S40	BHM5X0.8X10	BCL6	BHM6X1X20	L-W3	L-W4

EXTERNAL TOOL HOLDER WITH T-TYPE CLAMPING SYSTEM FOR CERAMIC INSERTS

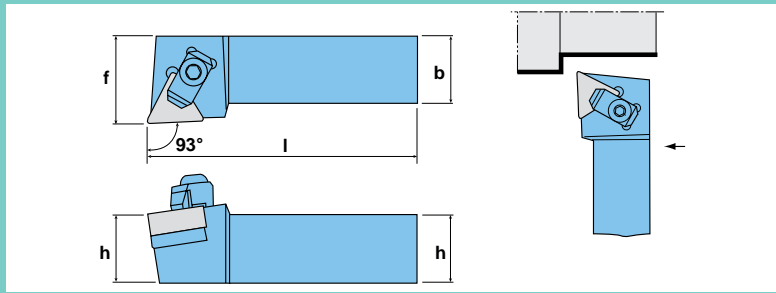

Designation	h	b	l	f
CTJNR12-3BCEA	0.750	0.750	4.500	1.000
CTJNR16-3DCEA	1.000	1.000	6.000	1.250

For inserts, see [page 1004](#).

HARDWARE							
	Accepts Insert Series	Seat	Seat Screw	Clamp	Clamp Screw	Seat Screw Wrench	Clamp Screw Wrench
CTJNR12-3BCEA	TNG33_	S3	BHM4X0.7X8	BCL6	BHM6X1X20	L-W3	L-W4
CTJNR16-3DCEA	TNG33_	S3	BHM4X0.7X8	BCL6	BHM6X1X20	L-W3	L-W4

EXTERNAL TOOL HOLDER WITH T-TYPE CLAMPING SYSTEM FOR DIMPLE CERAMIC INSERTS

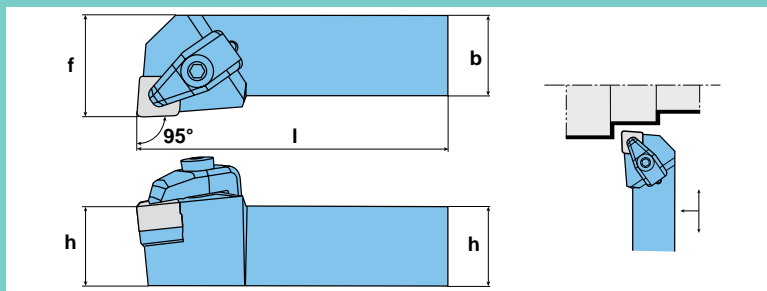

Designation	h	b	l	f
TCLNL16-4D-CH	1.000	1.000	6.000	1.250
TCLNR16-4D-CH	1.000	1.000	6.000	1.250
TCLNR20-4D-CH	1.250	1.250	6.000	1.500

For inserts, see [page 996](#).

HARDWARE								
	Accepts Insert Series	Seat	Seat Screw	Clamp	Clamp Screw	Clamp Spring	Seat Screw Wrench	Clamp Screw Wrench
TCLNL16-4D-CH	CNGX45_CH	S48	BHM5X0.8X10	CCL4	CSC4	DSP5	L-W3	L-W4
TCLNR16-4D-CH	CNGX45_CH	S48	BHM5X0.8X10	CCL4	CSC4	DSP5	L-W3	L-W4
TCLNR20-4D-CH	CNGX45_CH	S48	BHM5X0.8X10	CCL4	CSC4	DSP5	L-W3	L-W4

TOTURN™ TDJNR/L-CH

EXTERNAL TOOL HOLDER WITH T-TYPE CLAMPING SYSTEM FOR DIMPLE CERAMIC INSERTS

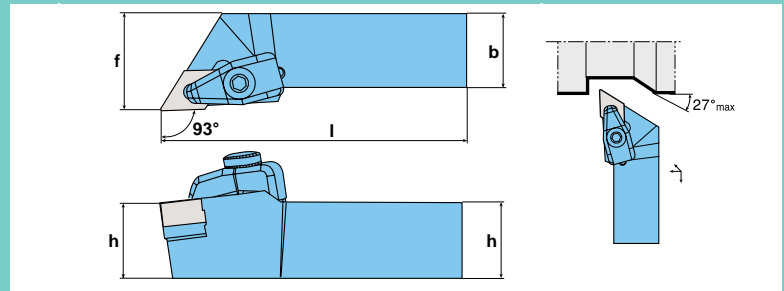

Designation	h	b	l	f
TDJNL16-4D-CH	1.000	1.000	6.000	1.250
TDJNR16-4D-CH	1.000	1.000	6.000	1.250

For inserts, see [page 997](#).





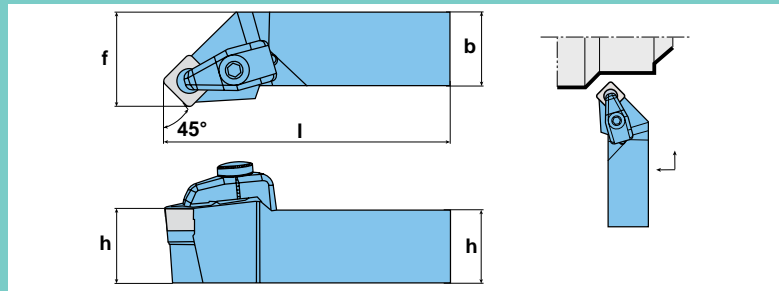



HARDWARE								
	Accepts Insert Series	Seat	Seat Screw	Clamp	Clamp Screw	Clamp Spring	Seat Screw Wrench	Clamp Screw Wrench
TDJNL16-4D-CH	DNGX45_CH	S45	BHM5X0.8X10	CCL4	CSC4	DSP5	L-W4	L-W3
TDJNR16-4D-CH	DNGX45_CH	S45	BHM5X0.8X10	CCL4	CSC4	DSP5	L-W4	L-W3

EXTERNAL TOOL HOLDER WITH T-TYPE CLAMPING SYSTEM FOR DIMPLE CERAMIC INSERTS



Designation	h	b	l	f
TSSNL16-4D-CH	1.000	1.000	6.000	1.250
TSSNR16-4D-CH	1.000	1.000	6.000	1.250

For inserts, see [page 1002](#).

HARDWARE								
	Accepts Insert Series	Seat	Seat Screw	Clamp	Clamp Screw	Clamp Spring	Seat Screw Wrench	Clamp Screw Wrench
TSSNL16-4D-CH	SNGX45_CH	S40	BHM5X0.8X10	CCL4	CSC4	DSP5	L-W4	L-W3
TSSNR16-4D-CH	SNGX45_CH	S40	BHM5X0.8X10	CCL4	CSC4	DSP5	L-W4	L-W3

INTERNAL TOP CLAMP TOOL HOLDER FOR 55° KNUX__ INSERTS

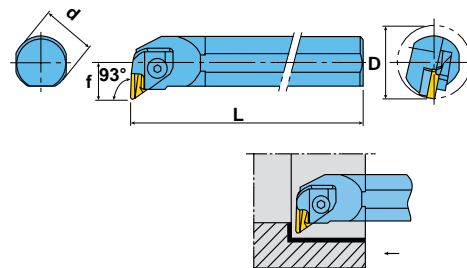

Designation	d	Dmin	L	f
S20U-CKUNL-3	1.250	1.570	14.00	0.765
S20U-CKUNR-3	1.250	1.570	14.00	0.765
S24V-CKUNL-3	1.500	1.970	16.00	1.063
S24V-CKUNR-3	1.500	1.970	16.00	1.063

For inserts, see [pages 920, 921](#).

HARDWARE										
	Accepts Insert Series	Seat	Seat Screw	Clamp	Clamp Screw	Clamp Spring	Pin	Pin and Spring	Seat Screw Wrench	Clamp Screw Wrench
S20U-CKUNL-3	KNUX333_L_	CSK1604L	FHM3X0.5X10	CL16KL	CLS16K	KSP90	KP48S	KSP48	L-W2	L-W4
S20U-CKUNR-3	KNUX333_R_	CSK1604R	FHM3X0.5X10	CL16KR	CLS16K	KSP90	KP48S	KSP48	L-W2	L-W4
S24V-CKUNL-3	KNUX333_L_	CSK1604L	FHM3X0.5X10	CL16KL	CLS16K	KSP90	KP48S	KSP48	L-W2	L-W4
S24V-CKUNR-3	KNUX333_R_	CSK1604R	FHM3X0.5X10	CL16KR	CLS16K	KSP90	KP48S	KSP48	L-W2	L-W4

INTERNAL TOP CLAMP TOOL HOLDER FOR POSITIVE 60° TP_ INSERTS

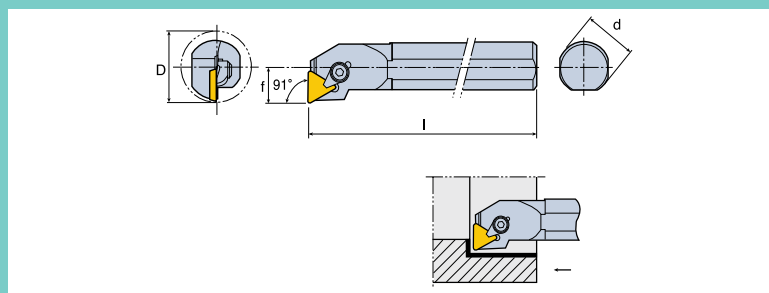

Designation	d	Dmin	L	f
S08R-CTFPR-2	0.500	6.000	8.00	0.312
S12S-CTFPL-3	0.750	1.000	10.00	0.500
S12S-CTFPR-3	0.750	1.000	10.00	0.500
S16T-CTFPR-3	1.000	1.280	12.00	0.640
S20U-CTFPR-3	1.250	1.530	14.00	0.765
S24U-CTFPR-3	1.500	1.840	14.00	0.890
S24U-CTFPR-4	1.500	2.060	14.00	0.890

For inserts, see [pages 980, 983, 985, 1005, 1015, 1021](#).

HARDWARE								
	Accepts Insert Series	Seat	Seat Screw	Clamp	Clamp Screw	Clamp Clip	Seat Screw Wrench	Clamp Screw Wrench
S08R-CTFPR-2	TP_22_	-	-	HC7	SHC7	-	-	AG00093LLA 3/32"
S12S-CTFPL-3	TP_32_	-	-	HC12	CS126	CLP12	-	L-W4
S12S-CTFPR-3	TP_32_	-	-	HC12	CS126	CLP12	-	L-W4
S16T-CTFPR-3	TP_32_	SM-41	TS-44-2	HC12	CS126	CLP12	T10	L-W4
S20U-CTFPR-3	TP_32_	SM-41	TS-44-2	HC12	CS126	CLP12	T10	L-W4
S24U-CTFPR-3	TP_32_	SM-41	TS-44-2	HC12	CS126	CLP12	T10	L-W4
S24U-CTFPR-4	TP_43_	SM-37	TS-6	HC12	CS126	CLP12	T20	L-W4

INTERNAL TOP CLAMP TOOL HOLDER FOR 80° CN__ INSERTS

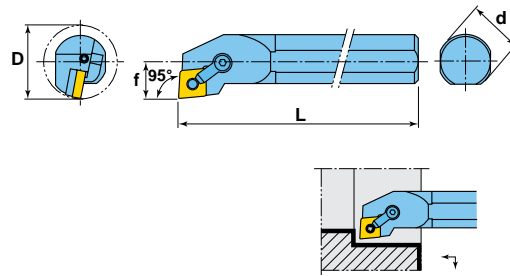

Designation	d	Dmin	L	f
S12S-MCLNL-3	0.750	1.000	10.00	0.500
S12S-MCLNR-3	0.750	1.000	10.00	0.500
S16T-MCLNL-3	1.000	1.280	12.00	0.640
S12S-MCLNL-4	0.750	1.000	10.00	0.500
S12S-MCLNR-4	0.750	1.000	10.00	0.500
S16T-MCLNL-4	1.000	1.280	12.00	0.640
S16T-MCLNR-4	1.000	1.280	12.00	0.640
S20U-MCLNL-4	1.250	1.530	14.00	0.765
S20U-MCLNR-4	1.250	1.530	14.00	0.765
S24U-MCLNL-4	1.500	1.780	14.00	0.890
S24U-MCLNR-4	1.500	1.780	14.00	0.890
S28U-MCLNR-4	1.750	2.030	14.00	1.015
S32V-MCLNL-4	2.000	2.560	16.00	1.281
S32V-MCLNR-4	2.000	2.560	16.00	1.281
S24U-MCLNR-5	1.500	2.374	14.00	1.880
S32V-MCLNL-5	2.000	2.560	16.00	1.281
S32V-MCLNR-5	2.000	2.560	16.00	1.281
S40V-MCLNL-5	2.500	3.060	16.00	1.530
S40V-MCLNR-5	2.500	3.060	16.00	1.530
S32V-MCLNL-6	2.000	2.560	16.00	1.281
S32V-MCLNR-6	2.000	2.560	16.00	1.281
S40V-MCLNR-6	2.500	3.060	16.00	1.530

For inserts, see pages 894 - 908, 993, 994, 996, 1009, 1018.

INTERNAL TOP CLAMP TOOL HOLDER FOR 80° CN__ INSERTS

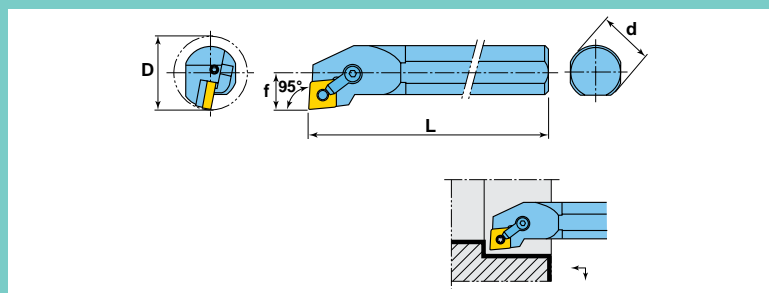

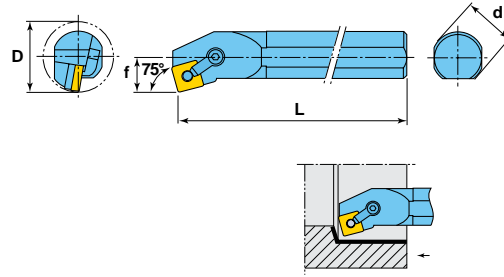

Hardware										
	AdaptivarserteSeries	hardwaredesc 2	hardwaredesc 3	hardwaredesc 4	hardwaredesc 5	ClampGrenzwert	bauteilWahlVorschl	hardware desc 8	hardware desc 9	hardware desc 10
S12S-MCLNL-3	CN_33_	-	CL7	XNS36	NL33	AG00093LLA 3/32"	AG00078LLA 5/64"			
S12S-MCLNR-3	CN_33_	-	CL7	XNS36	NL33	AG00093LLA 3/32"	AG00078LLA 5/64"			
S16T-MCLNL-3	CN_33_	-	CL7	XNS36	NL33	AG00093LLA 3/32"	AG00078LLA 5/64"			
S12S-MCLNL-4	CN_43_	-	CL20	XNS47	NL44	AG00125LLA 1/8"	AG00093LLA 3/32"			
S12S-MCLNR-4	CN_43_	-	CL20	XNS47	NL44	AG00125LLA 1/8"	AG00093LLA 3/32"			
S16T-MCLNL-4	CN_43_	-	CL20	XNS47	NL44	AG00125LLA 1/8"	AG00093LLA 3/32"			
S16T-MCLNR-4	CN_43_	-	CL20	XNS47	NL44	AG00125LLA 1/8"	AG00093LLA 3/32"			
S20U-MCLNL-4	CN_43_	ICSN433	CL20	XNS48	NL46	AG00125LLA 1/8"	AG00093LLA 3/32"			
S20U-MCLNR-4	CN_43_	ICSN433	CL20	XNS48	NL46	AG00125LLA 1/8"	AG00093LLA 3/32"			
S24U-MCLNL-4	CN_43_	ICSN433	CL20	XNS48	NL46	AG00125LLA 1/8"	AG00093LLA 3/32"			
S24U-MCLNR-4	CN_43_	ICSN433	CL20	XNS48	NL46	AG00125LLA 1/8"	AG00093LLA 3/32"			
S28U-MCLNR-4	CN_43_	ICSN433	CL20	XNS48	NL46	AG00125LLA 1/8"	AG00093LLA 3/32"			
S32V-MCLNL-4	CN_43_	ICSN433	CL20	XNS48	NL46	AG00125LLA 1/8"	AG00093LLA 3/32"			
S32V-MCLNR-4	CN_43_	ICSN433	CL20	XNS48	NL46	AG00125LLA 1/8"	AG00093LLA 3/32"			
S24U-MCLNR-5	CN_54_	ICSN533	CL12	XNS510	NL58	5/32HEX	AG00125LLA 1/8"			
S32V-MCLNL-5	CN_54_	ICSN533	CL12	XNS510	NL58	5/32HEX	AG00125LLA 1/8"			
S32V-MCLNR-5	CN_54_	ICSN533	CL12	XNS510	NL58	5/32HEX	AG00125LLA 1/8"			
S40V-MCLNL-5	CN_54_	ICSN533	CL12	XNS510	NL58	5/32HEX	AG00125LLA 1/8"			
S40V-MCLNR-5	CN_54_	ICSN533	CL12	XNS510	NL58	5/32HEX	AG00125LLA 1/8"			
S32V-MCLNL-6	CN_64_	ICSN633	CL12	XNS510	NL68	5/32HEX	AG00140LLA 9/64"			
S32V-MCLNR-6	CN_64_	ICSN633	CL12	XNS510	NL68	5/32HEX	AG00140LLA 9/64"			
S40V-MCLNR-6	CN_64_	ICSN633	CL12	XNS510	NL68	5/32HEX	AG00140LLA 9/64"			

INTERNAL TOP CLAMP TOOL HOLDER FOR SN__ INSERTS



Designation	d	Dmin	L	f
S20U-MSKNL-4	1.250	1.470	14.00	0.765
S20U-MSKNR-4	1.250	1.470	14.00	0.765
S24U-MSKNL-4	1.500	1.760	14.00	0.890

For inserts, see page 922 - 931, 1000, 1002, 1013, 1020.

HARDWARE							
	Accepts Insert Series	Seat	Clamp	Clamp Screw	Lock Pin	Clamp Screw Wrench	Lock Pin Wrench
S20U-MSKNL-4	SN_43_	-	CL20	XNS47	NL46	AG00125LLA 1/8" AG00093LLA 3/32"	
S20U-MSKNR-4	SN_43_	-	CL20	XNS47	NL46	AG00125LLA 1/8" AG00093LLA 3/32"	
S24U-MSKNL-4	SN_43_	ISSN433	CL20	XNS47	NL46	AG00125LLA 1/8" AG00093LLA 3/32"	

INTERNAL TOOL HOLDER WITH MULTI LOCK CLAMP FOR 60° TN__ INSERTS

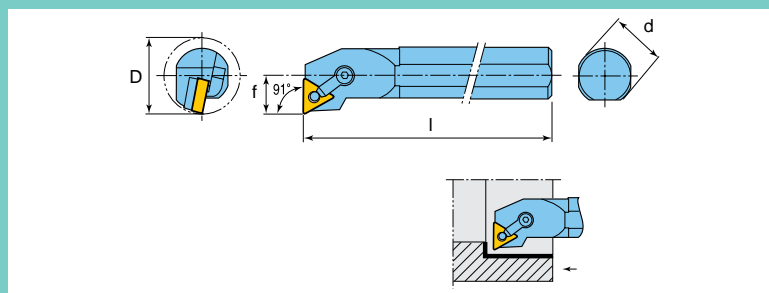

Designation	d	Dmin	L	f
S16T-MTFNL-3	1.000	1.280	12.00	0.640
S16T-MTFNR-3	1.000	1.280	12.00	0.640
S20U-MTFNL-3	1.250	1.530	14.00	0.765
S20U-MTFNR-3	1.250	1.530	14.00	0.765
S24U-MTFNR-3	1.500	1.780	14.00	0.890
S20U-MTFNR-4	1.250	1.530	14.00	0.765
S24U-MTFNL-4	1.500	2.060	14.00	0.890
S24U-MTFNR-4	1.500	2.060	14.00	0.890
S28U-MTFNR-4	1.750	2.312	14.00	1.156
S32V-MTFNL-4	2.000	2.562	16.00	1.281
S32V-MTFNR-4	2.000	2.562	16.00	1.281

For inserts, see [pages 932 - 944, 1003, 1004, 1015, 1021](#).



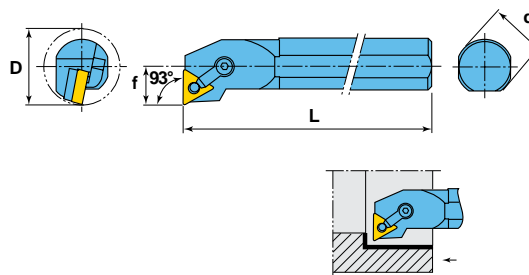

S16T-MTFNL-3	S16T-MTFNR-3	S20U-MTFNL-3	S20U-MTFNR-3	S24U-MTFNR-3	S20U-MTFNR-4	S24U-MTFNL-4	S24U-MTFNR-4	S28U-MTFNR-4	S32V-MTFNL-4	S32V-MTFNR-4	HARDWARE	
											Accepts Insert Series	Seat
TN__33_	TN__33_	TN__33_	TN__33_	TN__33_	TN__43_	TN__43_	TN__43_	TN__43_	TN__43_	TN__43_	ITSN322	ITSN433
CL7	CL7	CL7	CL7	CL7	CL9	CL9	CL9	CL9	CL9	CL9	CL7	CL9
XNS35	XNS35	XNS35	XNS35	XNS35	XNS59	XNS59	XNS59	XNS59	XNS59	XNS59	XNS35	XNS59
NL34L	NL34L	NL34L	NL34L	NL34L	NL46	NL46	NL46	NL46	NL46	NL46	NL34L	NL46
AG00093LLA 3/32"	AG00093LLA 3/32"	AG00093LLA 3/32"	AG00093LLA 3/32"	AG00093LLA 3/32"	5/32HEX	5/32HEX	5/32HEX	5/32HEX	5/32HEX	5/32HEX	AG00078LLA 5/64"	AG00093LLA 3/32"

INTERNAL TOOL HOLDER WITH MULTI LOCK CLAMP FOR 60° TN__ INSERTS



Designation	d	Dmin	L	f
S16T-MTUNL-3	1.000	1.280	12.00	0.640
S16T-MTUNR-3	1.000	1.280	12.00	0.640
S20U-MTUNR-3	1.250	1.530	14.00	0.765
S24U-MTUNL-3	1.500	2.060	14.00	0.890
S24U-MTUNR-3	1.500	2.060	14.00	0.890
S20U-MTUNL-4	1.250	1.530	14.00	0.765
S20U-MTUNR-4	1.250	1.530	14.00	0.765
S24U-MTUNL-4	1.500	2.060	14.00	0.890
S24U-MTUNR-4	1.500	2.060	14.00	0.890
S32V-MTUNL-4	2.000	2.562	16.00	1.281
S32V-MTUNR-4	2.000	2.562	16.00	1.281

For inserts, see [pages 932 - 944, 1003, 1004, 1015, 1021](#).

HARDWARE							
	Accepts Insert Series	Seat	Clamp	Clamp Screw	Lock Pin	Clamp Screw Wrench	Lock Pin Wrench
S16T-MTUNL-3	TN__33_	ITSN322	CL7	XNS35	NL34L	AG00093LLA 3/32" AG00078LLA 5/64"	
S16T-MTUNR-3	TN__33_	ITSN322	CL7	XNS35	NL34L	AG00093LLA 3/32" AG00078LLA 5/64"	
S20U-MTUNR-3	TN__33_	ITSN322	CL7	XNS35	NL34L	AG00093LLA 3/32" AG00078LLA 5/64"	
S24U-MTUNL-3	TN__33_	ITSN322	CL7	XNS35	NL34L	AG00093LLA 3/32" AG00078LLA 5/64"	
S24U-MTUNR-3	TN__33_	ITSN322	CL7	XNS35	NL34L	AG00093LLA 3/32" AG00078LLA 5/64"	
S20U-MTUNL-4	TN__43_	ITSN433	CL9	XNS59	NL46	5/32HEX AG00093LLA 3/32"	
S20U-MTUNR-4	TN__43_	ITSN433	CL9	XNS59	NL46	5/32HEX AG00093LLA 3/32"	
S24U-MTUNL-4	TN__43_	ITSN433	CL9	XNS59	NL46	5/32HEX AG00093LLA 3/32"	
S24U-MTUNR-4	TN__43_	ITSN433	CL9	XNS59	NL46	5/32HEX AG00093LLA 3/32"	
S32V-MTUNL-4	TN__43_	ITSN433	CL9	XNS59	NL46	5/32HEX AG00093LLA 3/32"	
S32V-MTUNR-4	TN__43_	ITSN433	CL9	XNS59	NL46	5/32HEX AG00093LLA 3/32"	

INTERNAL TOOL HOLDER WITH MULTI LOCK CLAMP FOR 35° VN__ INSERTS

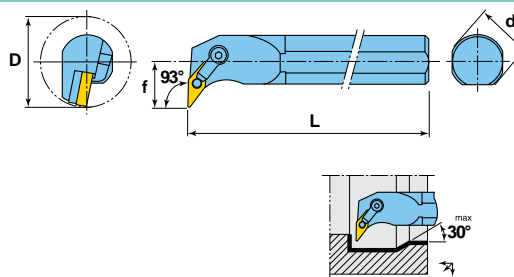

Designation	d	Dmin	L	f
S20U-MVUNL-3	1.250	2.250	14.00	1.125
S20U-MVUNR-3	1.250	2.250	14.00	1.125
S24U-MVUNL-3	1.500	2.500	14.00	1.250
S24U-MVUNR-3	1.500	2.500	14.00	1.250

For inserts, see [pages 944 - 949, 1005, 1016, 1023](#).





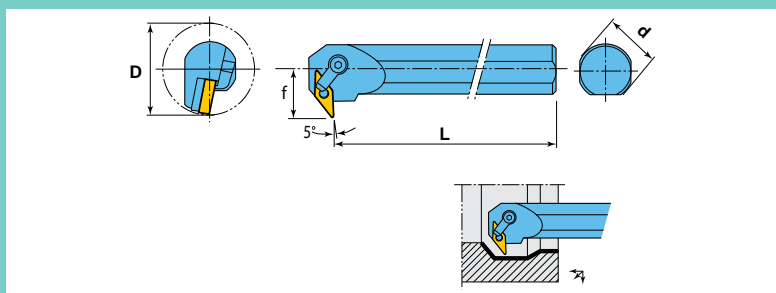

HARDWARE							
	Accepts Insert Series	Seat	Clamp	Clamp Screw	Lock Pin	Clamp Screw Wrench	Lock Pin Wrench
S20U-MVUNL-3	VN__33__	IVSN322	CL30	XNS510	NL34L	5/32HEX	AG00078LLA 5/64"
S20U-MVUNR-3	VN__33__	IVSN322	CL30	XNS510	NL34L	5/32HEX	AG00078LLA 5/64"
S24U-MVUNL-3	VN__33__	IVSN322	CL30	XNS510	NL34L	5/32HEX	AG00078LLA 5/64"
S24U-MVUNR-3	VN__33__	IVSN322	CL30	XNS510	NL34L	5/32HEX	AG00078LLA 5/64"

INTERNAL TOOL HOLDER WITH MULTI LOCK CLAMP FOR 35° VN__ INSERTS



Designation	d	Dmin	L	f
S24U-MVXNL-3	1.500	2.250	14.00	1.125
S24U-MVXNR-3	1.500	2.250	14.00	1.125
S28U-MVXNR-3	1.750	2.500	14.00	1.250

For inserts, see pages 944 - 949, 1005, 1016, 1023.

HARDWARE							
	Accepts Insert Series	Seat	Clamp	Clamp Screw	Lock Pin	Clamp Screw Wrench	Lock Pin Wrench
S24U-MVXNL-3	VN__33__	IVSN322	CL20	XNS48	NL34L	AG00125LLA 1/8" AG00078LLA 5/64"	
S24U-MVXNR-3	VN__33__	IVSN322	CL20	XNS48	NL34L	AG00125LLA 1/8" AG00078LLA 5/64"	
S28U-MVXNR-3	VN__33__	IVSN322	CL20	XNS48	NL34L	AG00125LLA 1/8" AG00078LLA 5/64"	

INTERNAL TOOL HOLDER WITH LEVER LOCK CLAMP FOR 80° CN__ INSERTS

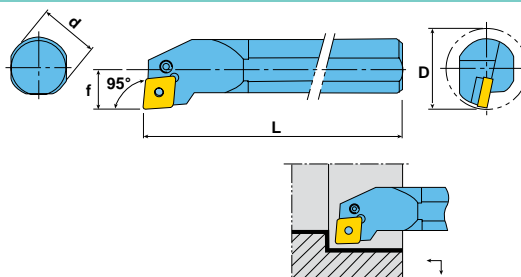

Designation	d	Dmin	L	f
S10R-PCLNL-3	0.625	0.812	8.00	0.405
S10R-PCLNR-3	0.625	0.812	8.00	0.405
S12S-PCLNL-3	0.750	1.000	10.00	0.500
S12S-PCLNR-3	0.750	1.000	10.00	0.500
S16T-PCLNL-3	1.000	1.250	12.00	0.625
S16T-PCLNR-3	1.000	1.250	12.00	0.625

For inserts, see [pages 895, 899, 901 - 903](#).



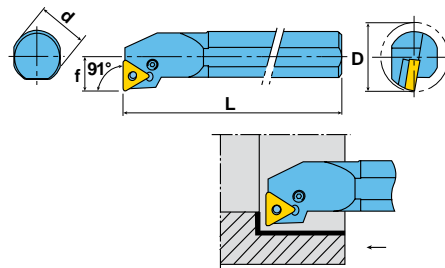

HARDWARE					
	Accepts Insert Series	Clamp Clip	Lever	Lever Screw	Lever Screw Wrench
S10R-PCLNL-3	CN__32__	LSR3B	LCL3B	LCS2B	L-W2
S10R-PCLNR-3	CN__32__	LSR3B	LCL3B	LCS2B	L-W2
S12S-PCLNL-3	CN__32__	LSR3B	LCL3B	LCS2B	L-W2
S12S-PCLNR-3	CN__32__	LSR3B	LCL3B	LCS2B	L-W2
S16T-PCLNL-3	CN__32__	LSR3B	LCL3B	LCS2B	L-W2
S16T-PCLNR-3	CN__32__	LSR3B	LCL3B	LCS2B	L-W2

INTERNAL TOOL HOLDER WITH LEVER LOCK CLAMP FOR 60° TN__ INSERTS



Designation	d	Dmin	L	f
S10R-PTFNL-2	0.625	0.812	8.00	0.405
S10R-PTFNR-2	0.625	0.812	8.00	0.405
S12S-PTFNL-2	0.750	1.000	10.00	0.500
S12S-PTFNR-2	0.750	1.000	10.00	0.500
S16T-PTFNL-2	1.000	1.250	12.00	0.625
S16T-PTFNR-2	1.000	1.250	12.00	0.625

For inserts, see [pages 933, 934, 936, 940](#).

HARDWARE					
	Accepts Insert Series	Clamp Clip	Lever	Lever Screw	Lever Screw Wrench
S10R-PTFNL-2	TN__22__	LSR2B	LCL2B	LCS2B	L-W2
S10R-PTFNR-2	TN__22__	LSR2B	LCL2B	LCS2B	L-W2
S12S-PTFNL-2	TN__22__	LSR2B	LCL2B	LCS2B	L-W2
S12S-PTFNR-2	TN__22__	LSR2B	LCL2B	LCS2B	L-W2
S16T-PTFNL-2	TN__22__	LSR2B	LCL2B	LCS2B	L-W2
S16T-PTFNR-2	TN__22__	LSR2B	LCL2B	LCS2B	L-W2

TOTURN™ E-SCLCR/L (CARBIDE)

INTERNAL CARBIDE SHANK TOOL HOLDER WITH SCREW CLAMP FOR 80° CC__ INSERTS

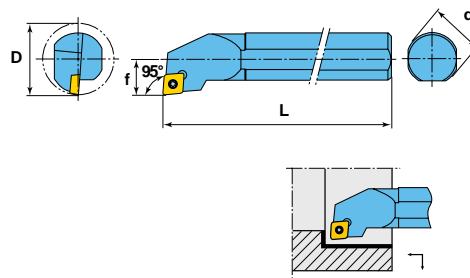





Designation	d	Dmin	L	f
E06M-SCLCL-2	0.375	0.500	6.00	0.250
E06M-SCLCR-2	0.375	0.500	6.00	0.250
E08M-SCLCL-2	0.500	0.625	6.00	0.312
E08M-SCLCR-2	0.500	0.625	6.00	0.312
E08R-SCLCL-3	0.500	0.625	8.00	0.312
E08R-SCLCR-3	0.500	0.625	8.00	0.312
E10R-SCLCL-3	0.625	0.780	8.00	0.438
E10R-SCLCR-3	0.625	0.780	8.00	0.438
E12S-SCLCL-3	0.750	0.985	10.00	0.500
E12S-SCLCR-3	0.750	0.985	10.00	0.500
E16T-SCLCR-3	1.000	1.280	12.00	0.625

For inserts, see [pages 961 - 965, 990, 1008 & 1018](#).

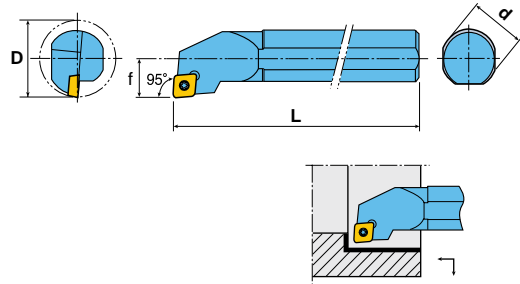
DESIGNATION	HARDWARE		
	Accepts Insert Series	Insert Screw	Torx Driver
E06M-SCLCL-2	CC_T21.5_	SM25-065-70	DS-T07F
E06M-SCLCR-2	CC_T21.5_	SM25-065-70	DS-T07F
E08M-SCLCL-2	CC_T21.5_	SM25-065-70	DS-T07F
E08M-SCLCR-2	CC_T21.5_	SM25-065-70	DS-T07F
E08R-SCLCL-3	CC_T32.5_	S035080I	DS-T15S
E08R-SCLCR-3	CC_T32.5_	S035080I	DS-T15S
E10R-SCLCL-3	CC_T32.5_	S035080I	DS-T15S
E10R-SCLCR-3	CC_T32.5_	S035080I	DS-T15S
E12S-SCLCL-3	CC_T32.5_	S035080I	DS-T15S
E12S-SCLCR-3	CC_T32.5_	S035080I	DS-T15S
E16T-SCLCR-3	CC_T32.5_	S035080I	DS-T15S

INTERNAL TOOL HOLDER WITH SCREW CLAMPING FOR POSITIVE 80° CC__ INSERTS



Designation	d	Dmin	L	f			
					Accepts Insert Series	Insert Screw	Torx Driver
S06H-SCLCL-2	0.375	0.394	4.00	0.236	CC_T21.5_	TS-25.45-6M1	DS-T07F
S06H-SCLCR-2	0.375	0.394	4.00	0.236	CC_T21.5_	TS-25.45-6M1	DS-T07F
S06M-SCLCL-2	0.375	0.500	6.00	0.250	CC_T21.5_	1425	5507
S06M-SCLCR-2	0.375	0.500	6.00	0.250	CC_T21.5_	1425	5507
S08K-SCLCL-2	0.500	0.550	5.00	0.275	CC_T21.5_	TS-25.45-6M1	DS-T07F
S08K-SCLCR-2	0.500	0.550	5.00	0.275	CC_T21.5_	TS-25.45-6M1	DS-T07F
S08M-SCLCL-2	0.500	0.602	6.00	0.312	CC_T21.5_	TS-25.45-6M1	DS-T07F
S08M-SCLCR-2	0.500	0.602	6.00	0.312	CC_T21.5_	TS-25.45-6M1	DS-T07F
S10M-SCLCL-2	0.625	0.708	6.00	0.354	CC_T21.5_	TS-25.45-6M1	DS-T07F
S10M-SCLCR-2	0.625	0.708	6.00	0.354	CC_T21.5_	TS-25.45-6M1	DS-T07F
S10R-SCLCL-2	0.625	0.812	8.00	0.406	CC_T21.5_	TS-25.45-6M1	DS-T07F
S10R-SCLCR-2	0.625	0.812	8.00	0.406	CC_T21.5_	TS-25.45-6M1	DS-T07F
S08M-SCLCL-3	0.500	0.625	6.00	0.312	CC_T32.5_	TS-4.7-8M1	DS-T15S
S08M-SCLCR-3	0.500	0.625	6.00	0.312	CC_T32.5_	TS-4.7-8M1	DS-T15S
S10R-SCLCL-3	0.625	0.812	8.00	0.406	CC_T32.5_	1440	DS-T15S
S10R-SCLCR-3	0.625	0.812	8.00	0.406	CC_T32.5_	1440	DS-T15S
S12S-SCLCL-3	0.750	0.954	10.00	0.500	CC_T32.5_	TS-4.7-10M1	DS-T15S
S12S-SCLCR-3	0.750	0.954	10.00	0.500	CC_T32.5_	TS-4.7-10M1	DS-T15S
S16T-SCLCL-3	1.000	1.280	12.00	0.640	CC_T32.5_	1440	DS-T15S
S16T-SCLCR-3	1.000	1.280	12.00	0.640	CC_T32.5_	1440	DS-T15S
S16T-SCLCL-4	1.000	1.280	12.00	0.640	CC_T43_	1250	T20
S16T-SCLCR-4	1.000	1.280	12.00	0.640	CC_T43_	1250	T20
S20U-SCLCL-4	1.250	1.530	14.00	0.765	CC_T43_	TS-5.8-10M1	T20
S20U-SCLCR-4	1.250	1.530	14.00	0.765	CC_T43_	TS-5.8-10M1	T20
S24U-SCLCL-4	1.500	1.780	14.00	0.890	CC_T43_	TS-5.8-10M1	T20
S24U-SCLCR-4	1.500	1.780	14.00	0.890	CC_T43_	TS-5.8-10M1	T20

For inserts, see [pages 961 - 965, 990, 1008 & 1018](#).

TOTURN™ S-SCFPR/L

INTERNAL TOOL HOLDER WITH SCREW CLAMPING FOR POSITIVE 80° CP__ INSERTS

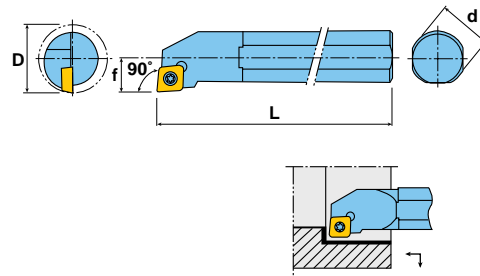





Designation	d	Dmin	L	f			
					Accepts Insert Series	Insert Screw	Torx Driver
S06M-SCFPL-2	0.375	0.480	6.00	0.250	CP_T21.5_	TS-25.45-6M1	DS-T07F
S06M-SCFPR-2	0.375	0.480	6.00	0.250	CP_T21.5_	TS-25.45-6M1	DS-T07F
S08R-SCFPL-2	0.500	0.600	8.00	0.312	CP_T21.5_	TS-25.45-6M1	DS-T07F
S08R-SCFPR-2	0.500	0.600	8.00	0.312	CP_T21.5_	TS-25.45-6M1	DS-T07F
S10S-SCFPL-2	0.625	0.770	10.00	0.406	CP_T21.5_	TS-25.45-6M1	DS-T07F
S10S-SCFPR-2	0.625	0.770	10.00	0.406	CP_T21.5_	TS-25.45-6M1	DS-T07F

For inserts, see [page 966](#).

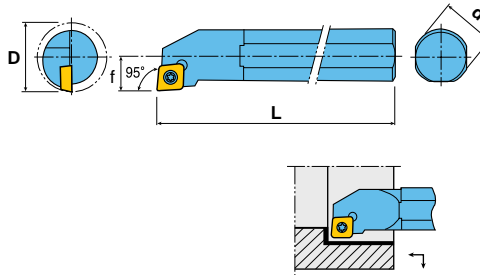
TOTURN™ S-SCLPR/L

INTERNAL TOOL HOLDER WITH SCREW CLAMPING FOR POSITIVE 80° CP__ INSERTS



Designation	d	Dmin	L	f			
					Accepts Insert Series	Insert Screw	Torx Driver
S06M-SCLPL-2	0.375	0.480	6.00	0.250	CP_T21.5_	TS-25.45-6M1	DS-T07F
S06M-SCLPR-2	0.375	0.480	6.00	0.250	CP_T21.5_	TS-25.45-6M1	DS-T07F
S08R-SCLPL-2	0.500	0.600	8.00	0.312	CP_T21.5_	TS-25.45-6M1	DS-T07F
S08R-SCLPR-2	0.500	0.600	8.00	0.312	CP_T21.5_	TS-25.45-6M1	DS-T07F
S10S-SCLPL-2	0.625	0.770	10.00	0.406	CP_T21.5_	TS-25.45-6M1	DS-T07F
S10S-SCLPR-2	0.625	0.770	10.00	0.406	CP_T21.5_	TS-25.45-6M1	DS-T07F
S12S-SCLPR-3	0.750	0.930	10.00	0.500	CP_T32.5_	TS-4.7-8M1	DS-T15S

For inserts, see [page 966](#).

TOTURN™ E-SDUCR (CARBIDE)

INTERNAL CARBIDE SHANK TOOL HOLDER WITH SCREW CLAMP FOR POSITIVE 55° DC__ INSERTS

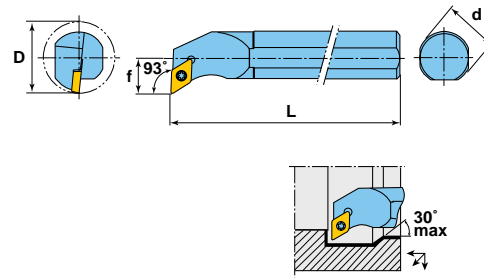

Designation	d	Dmin	L	f						
E06M-SDUCR-2	0.375	0.625	6.00	0.375	DC_T21.5_	-	SM25-065-70	-	-	DS-T07F
E08M-SDUCR-2	0.500	0.780	6.00	0.437	DC_T21.5_	-	SM25-065-70	-	-	DS-T07F
E10R-SDUCR-2	0.625	0.840	8.00	0.500	DC_T21.5_	-	SM25-065-70	-	-	DS-T07F
E12S-SDUCR-3	0.750	1.250	10.00	0.625	DC_T32.5_	-	S035080I	-	-	DS-T15S
E16T-SDUCR-3	1.000	1.500	12.00	0.750	DC_T32.5_	SSD32	S035080I	S050090S	L-W3	DS-T15S

For inserts, see [pages 967 - 970, 1010, 1019](#).

TOTURN™ S-SDUCR/L

INTERNAL TOOL HOLDER WITH SCREW CLAMPING FOR POSITIVE 55° DC__ INSERTS

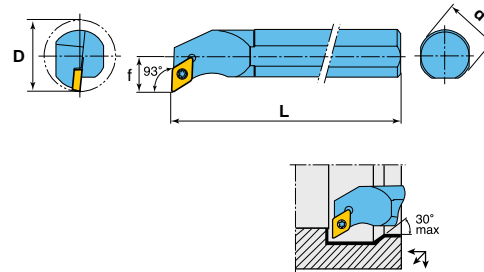

Designation	d	Dmin	L	f			
S06M-SDUCL-2	0.375	0.625	6.00	0.375	DC_T21.5_	TS-25.45-6M1	DS-T07F
S06M-SDUCR-2	0.375	0.625	6.00	0.375	DC_T21.5_	TS-25.45-6M1	DS-T07F
S08M-SDUCL-2	0.500	0.780	6.00	0.437	DC_T21.5_	TS-25.45-6M1	DS-T07F
S08M-SDUCR-2	0.500	0.780	6.00	0.437	DC_T21.5_	TS-25.45-6M1	DS-T07F
S10R-SDUCL-2	0.625	0.840	8.00	0.500	DC_T21.5_	TS-25.45-6M1	DS-T07F
S10R-SDUCR-2	0.625	0.840	8.00	0.500	DC_T21.5_	TS-25.45-6M1	DS-T07F
S12S-SDUCL-3	0.750	1.250	10.00	0.625	DC_T32.5_	1440	DS-T15S
S12S-SDUCR-3	0.750	1.250	10.00	0.625	DC_T32.5_	1440	DS-T15S
S16T-SDUCL-3	1.000	1.500	12.00	0.750	DC_T32.5_	TS-4.7-10M1	DS-T15S
S16T-SDUCR-3	1.000	1.500	12.00	0.750	DC_T32.5_	TS-4.7-10M1	DS-T15S
S20U-SDUCL-3	1.250	1.750	14.00	0.875	DC_T32.5_	TS-4.7-10M1	DS-T15S
S20U-SDUCR-3	1.250	1.750	14.00	0.875	DC_T32.5_	TS-4.7-10M1	DS-T15S

For inserts, see [pages 967 - 970, 1010, 1019](#).

TOTURN™ A-SDQNR/L

INTERNAL TOOL HOLDER WITH SCREW CLAMPING FOR NEGATIVE 55° DN__ INSERTS WITH INTERNAL COOLANT

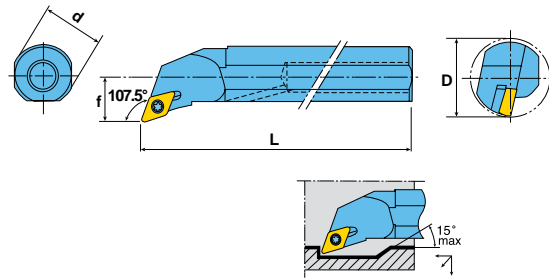

Designation	d	Dmin	L	f
A12M-SDQNR-3	0.750	1.000	6.00	-
A12S-SDQNL-3	0.750	1.000	10.00	-

For inserts, see pages 909, 911, 912, 915, 917.

Designation	HARDWARE						
	Accepts Insert Series	Seat	Insert Screw	Seat Screw	Seat Screw Wrench	Seal	Torx Driver
A12M-SDQNR-3	DN__33__	SSD32	S035120I	SM50-062-S0	L-W3.5	PL075	DS-T10T
A12S-SDQNL-3	DN__33__	SSD32	S035120I	S050090S	L-W3.5	PL075	DS-T10T

TOTURN™ A-SDUNR/L

INTERNAL TOOL HOLDER WITH SCREW CLAMPING FOR NEGATIVE 60° TC__ INSERTS WITH INTERNAL COOLANT

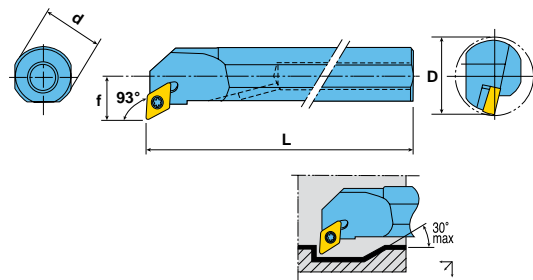

Designation	d	Dmin	L	f
A12S-SDUNL-3	0.750	1.100	10.00	0.625
A12S-SDUNR-3	0.750	1.100	10.00	0.625



For inserts, see pages 909, 911, 912, 915, 917.

Designation	HARDWARE						
	Accepts Insert Series	Seat	Insert Screw	Seat Screw	Seat Screw Wrench	Seal	Torx Driver
A12S-SDUNL-3	DN__33__	SSD32	S035120I	S050090S	L-W3.5	PL075	DS-T10T
A12S-SDUNR-3	DN__33__	SSD32	S035120I	S050090S	L-W3.5	PL075	DS-T10T

TOTURN™ E-STFCR/L (CARBIDE)

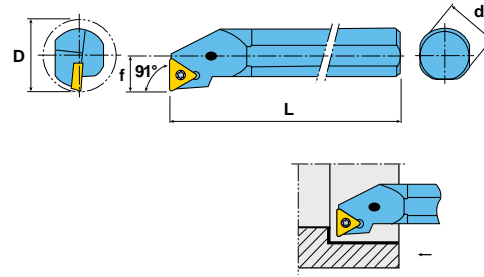
INTERNAL CARBIDE SHANK TOOL HOLDER WITH SCREW CLAMP FOR POSITIVE 55° DC__ INSERTS





Designation	d	Dmin	L	f			
					Adaptivlarserie 5er/ies	halsbreit 6 clew 2	halsbreit 6 er/ies 3
E06M-STFCL-2	0.375	0.500	6.00	0.250	TC_T21.5_	SM25-065-70	DS-T07F
E06M-STFCR-2	0.375	0.500	6.00	0.250	TC_T21.5_	SM25-065-70	DS-T07F
E08R-STFCL-2	0.500	0.625	8.00	0.312	TC_T21.5_	SM25-065-70	DS-T07F
E08R-STFCR-2	0.500	0.625	8.00	0.312	TC_T21.5_	SM25-065-70	DS-T07F
E10R-STFCL-2	0.625	0.812	8.00	0.406	TC_T21.5_	SM25-065-70	DS-T07F
E10R-STFCR-2	0.625	0.812	8.00	0.406	TC_T21.5_	SM25-065-70	DS-T07F
E12S-STFCL-2	0.750	1.000	10.00	0.500	TC_T21.5_	SM25-065-70	DS-T07F
E12S-STFCR-2	0.750	1.000	10.00	0.500	TC_T21.5_	SM25-065-70	DS-T07F

For inserts, see [pages 978, 979, 992, 1014, 1020](#).

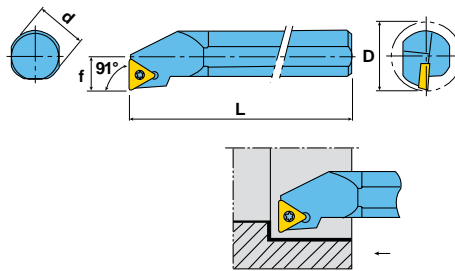
INTERNAL TOOL HOLDER WITH SCREW CLAMPING \FOR POSITIVE 60° TC__ INSERTS







Designation	d	Dmin	L	f			
					Accepts Insert Series	Insert Screw	Torx Driver
S06M-STFCL-2	0.375	0.500	6.00	0.250	TC_T21.5_	1425	DS-T07F
S06M-STFCR-2	0.375	0.500	6.00	0.250	TC_T21.5_	1425	DS-T07F
S08M-STFCL-2	0.500	0.625	6.00	0.312	TC_T21.5_	1425	DS-T07F
S08M-STFCR-2	0.500	0.625	6.00	0.312	TC_T21.5_	1425	DS-T07F
S10R-STFCL-2	0.625	0.812	8.00	0.406	TC_T21.5_	1425	DS-T07F
S10R-STFCR-2	0.625	0.812	8.00	0.406	TC_T21.5_	1425	DS-T07F
S12S-STFCL-2	0.750	1.000	10.00	0.500	TC_T21.5_	TS-25.45-6M1	DS-T07F
S12S-STFCR-2	0.750	1.000	10.00	0.500	TC_T21.5_	TS-25.45-6M1	DS-T07F
S16T-STFCR-3	1.000	1.280	12.00	0.640	TC_T32.5	TS-4.7-10M1	DS-T15S
S20U-STFCR-3	1.250	1.530	14.00	0.765	TC_T32.5	TS-4.7-10M1	DS-T15S
S24U-STFCR-3	1.500	1.780	14.00	0.890	TC_T32.5	TS-4.7-10M1	DS-T15S

For inserts, see [pages 978, 979, 992, 1014, 1020](#).

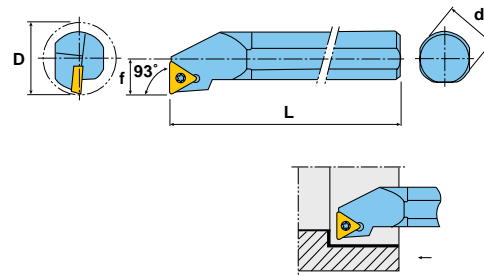
TOTURN™ S-STUCR/L

INTERNAL TOOL HOLDER WITH SCREW CLAMPING FOR POSITIVE 60° TC__ INSERTS



Designation	d	Dmin	L	f			
					Accepts Insert Series	Insert Screw	Torx Driver
S06M-STUCL-2	0.375	0.477	6.00	0.250	TC_T21.5_	TS-25.45-6M1	DS-T07F
S06M-STUCR-2	0.375	0.477	6.00	0.250	TC_T21.5_	TS-25.45-6M1	DS-T07F
S08M-STUCL-2	0.500	0.602	6.00	0.312	TC_T21.5_	TS-25.45-6M1	DS-T07F
S08M-STUCR-2	0.500	0.602	6.00	0.312	TC_T21.5_	TS-25.45-6M1	DS-T07F
S10R-STUCL-2	0.625	0.797	8.00	0.406	TC_T21.5_	TS-25.45-6M1	DS-T07F
S10R-STUCR-2	0.625	0.797	8.00	0.406	TC_T21.5_	TS-25.45-6M1	DS-T07F
S12S-STUCL-3	0.750	0.954	10.00	0.500	TC_T32.5	TS-4.7-10M1	DS-T15S
S12S-STUCR-3	0.750	0.954	10.00	0.500	TC_T32.5	TS-4.7-10M1	DS-T15S
S16T-STUCL-3	1.000	1.280	12.00	0.640	TC_T32.5	TS-4.7-10M1	DS-T15S
S16T-STUCR-3	1.000	1.280	12.00	0.640	TC_T32.5	TS-4.7-10M1	DS-T15S

For inserts, see [pages 978, 979, 992, 1014, 1020](#).

TOTURN™ S-STFPR/L

INTERNAL TOOL HOLDER WITH SCREW CLAMPING FOR POSITIVE 60° TP__ INSERTS

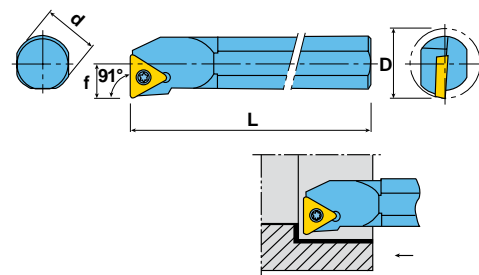

Designation	d	Dmin	L	f			
					Accepts Insert Series	Insert Screw	Torx Driver
S06M-STFPR-2	0.375	0.470	6.00	0.250	TP_T21.5_	TS-25.45-6M1	DS-T07F
S08M-STFPL-2	0.500	0.600	6.00	0.312	TP_T21.5_	TS-25.45-6M1	DS-T07F
S08M-STFPR-2	0.500	0.600	6.00	0.312	TP_T21.5_	TS-25.45-6M1	DS-T07F
S10R-STFPL-2	0.625	0.770	8.00	0.406	TP_T21.5_	TS-25.45-6M1	DS-T07F
S10R-STFPR-2	0.625	0.770	8.00	0.406	TP_T21.5_	TS-25.45-6M1	DS-T07F
S12S-STFPR-3	0.750	0.930	10.00	0.500	TP_T32.5_	TS-44-3M	DS-T15S

For inserts, see [page 984](#).

INTERNAL TOOL HOLDER WITH SCREW CLAMPING FOR 35° VN__ INSERTS

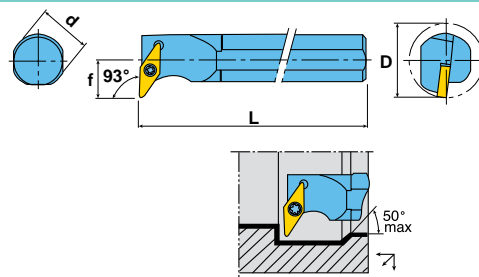
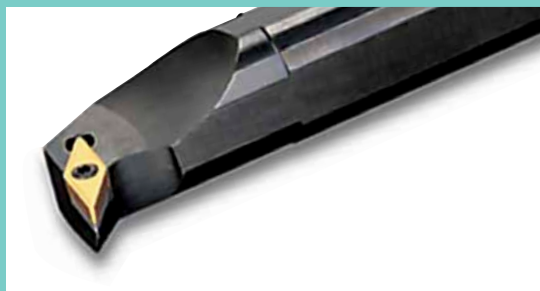

Designation	d	Dmin	L	f
A12S-SVUNL-2.5	0.750	1.100	10.00	0.625
A12S-SVUNR-2.5	0.750	1.100	10.00	0.625
A16T-SVUNL-2.5	1.000	1.220	12.00	0.625
A16T-SVUNR-2.5	1.000	1.220	12.00	0.625
A20U-SVUNL-2.5	1.250	1.480	14.00	0.750
A20U-SVUNR-2.5	1.250	1.480	14.00	0.750



For inserts, see [pages 947, 948](#).

HARDWARE							
	Accepts Insert Series	Seat	Insert Screw	Seat Screw	Seat Screw Wrench	Seal	Torx Driver
A12S-SVUNL-2.5	VN__2.53_	SSVN2.522	S035120I	S050090S	L-W3.5	PL075	DS-T10T
A12S-SVUNR-2.5	VN__2.53_	SSVN2.522	S035120I	S050090S	L-W3.5	PL075	DS-T10T
A16T-SVUNL-2.5	VN__2.53_	SSVN2.522	S035120I	S050090S	L-W3.5	PL100	DS-T10T
A16T-SVUNR-2.5	VN__2.53_	SSVN2.522	S035120I	S050090S	L-W3.5	PL100	DS-T10T
A20U-SVUNL-2.5	VN__2.53_	SSVN2.522	S035120I	S050090S	L-W3.5	PL125	DS-T10T
A20U-SVUNR-2.5	VN__2.53_	SSVN2.522	S035120I	S050090S	L-W3.5	PL125	DS-T10T

TOTURN™ S-SVQBR/L

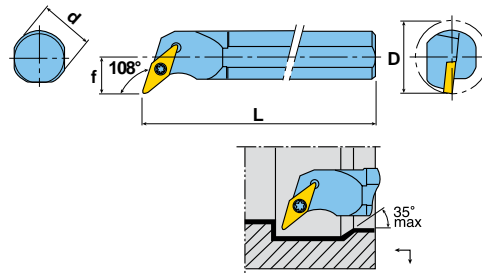
INTERNAL TOOL HOLDER WITH SCREW CLAMPING FOR POSITIVE 35° VB__ INSERTS



Designation	d	Dmin	L	f			
S16T-SVQBL-3	1.000	1.300	12.00	0.750	VB_T33_	TS-4.7-10M1	DS-T155
S16T-SVQBR-3	1.000	1.300	12.00	0.750	VB_T33_	TS-4.7-10M1	DS-T155

For inserts, see pages 986 - 989, 1016, 1022.





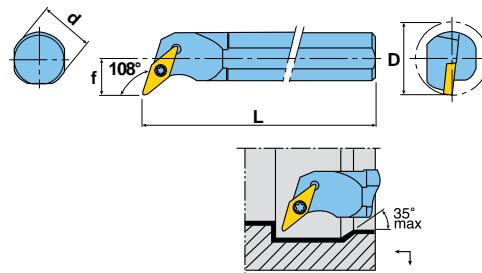

TOTURN™ S-SVQCR/L

INTERNAL TOOL HOLDER WITH SCREW CLAMPING FOR POSITIVE 60° VC__ INSERTS



Designation	d	Dmin	L	f
S12S-SVQCL-2	0.750	0.980	10.00	0.562
S12S-SVQCR-2	0.750	0.980	10.00	0.562
S16T-SVQCL-3	1.000	1.375	12.00	0.750
S16T-SVQCR-3	1.000	1.375	12.00	0.750
S24V-SVQCL-3	1.500	2.000	16.00	1.063
S24V-SVQCR-3	1.500	2.000	16.00	1.063

For inserts, see pages 992, 1022.

HARDWARE						
	Accepts Insert Series	Seat	Insert Screw	Seat Screw	Seat Screw Wrench	Torx Driver
S12S-SVQCL-2	VC_T22_	-	TS-25.45-6M1	-	-	DS-T07F
S12S-SVQCR-2	VC_T22_	-	TS-25.45-6M1	-	-	DS-T07F
S16T-SVQCL-3	VC_T33_	-	1240	-	-	5515
S16T-SVQCR-3	VC_T33_	-	1240	-	-	5515
S24V-SVQCL-3	VC_T33_	3718	1335	1750	5516	5516
S24V-SVQCR-3	VC_T33_	3718	1335	1750	5516	5516

INTERNAL TOOL HOLDER WITH SCREW CLAMPING FOR POSITIVE 60° VC__ INSERTS

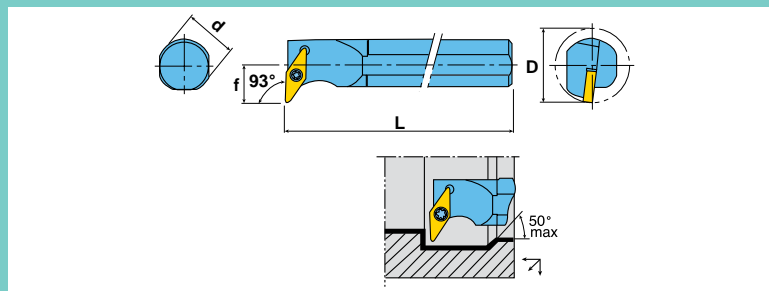

Designation	d	Dmin	L	f
S12S-SVUCR-2	0.750	1.125	10.00	0.625
S16T-SVUCR-2	1.000	1.300	12.00	0.750
S16T-SVUCL-3	1.000	2.000	12.00	0.750
S20U-SVUCL-3	1.250	2.250	14.00	1.000
S20U-SVUCR-3	1.250	2.250	14.00	1.000
S24V-SVUCL-3	1.500	2.250	16.00	1.125
S24V-SVUCR-3	1.500	2.250	16.00	1.125

For inserts, see [pages 992, 1022](#).

HARDWARE						
	Accepts Insert Series	Seat	Insert Screw	Seat Screw	Seat Screw Wrench	Torx Driver
S12S-SVUCR-2	VC_T22_	-	TS-25.45-6M1	-	-	DS-T07F
S16T-SVUCR-2	VC_T22_	-	TS-25.45-6M1	-	-	DS-T07F
S16T-SVUCL-3	VC_T33_	-	TS-4.7-10M1	-	-	DS-T15S
S20U-SVUCL-3	VC_T33_	-	TS-4.7-10M1	-	-	DS-T15S
S20U-SVUCR-3	VC_T33_	-	TS-4.7-10M1	-	-	DS-T15S
S24V-SVUCL-3	VC_T33_	3718	1335	1750	5516	5516
S24V-SVUCR-3	VC_T33_	3718	1335	1750	5516	5516

INTERNAL TOOL HOLDER WITH SCREW CLAMPING FOR POSITIVE 60° VC__ INSERTS

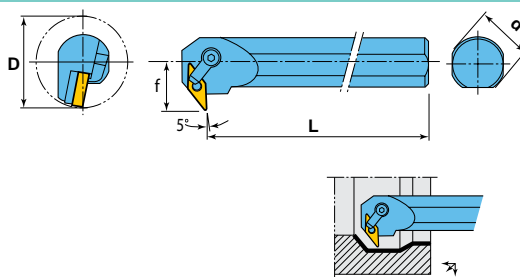

Designation	d	Dmin	L	f			
					Accepts Insert Series	Insert Screw	Torx Driver
S12S-SVXCR-2	0.750	1.125	10.00	0.625	VC_T22_	TS-25.45-6M1	DS-T07F
S16T-SVXCR-2	1.000	1.500	12.00	0.750	VC_T22_	TS-25.45-6M1	DS-T07F
S16T-SVXCL-3	1.000	2.000	12.00	0.750	VC_T33_	TS-4.7-10M1	DS-T15S
S16T-SVXCR-3	1.000	2.000	12.00	0.750	VC_T33_	TS-4.7-10M1	DS-T15S
S20U-SVXCL-3	1.250	2.250	14.00	1.000	VC_T33_	TS-4.7-10M1	DS-T15S
S20U-SVXCR-3	1.250	2.250	14.00	1.000	VC_T33_	TS-4.7-10M1	DS-T15S

For inserts, see [pages 992, 1022](#).

EXTERNAL TOOL HOLDER WITH T-TYPE CLAMPING SYSTEM FOR 80° CN__ INSERTS WITH INTERNAL COOLANT

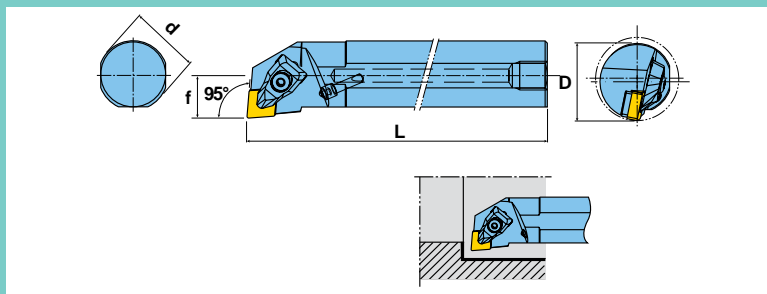

Designation	d	Dmin	L	f
A16T-TCLNL-4	1.000	1.250	12.00	0.640
A16T-TCLNR-4	1.000	1.250	12.00	0.640
A20U-TCLNL-4	1.250	1.500	14.00	0.770
A20U-TCLNR-4	1.250	1.500	14.00	0.770
A24U-TCLNL-4	1.500	1.750	14.00	0.890
A24U-TCLNR-4	1.500	1.750	14.00	0.890
A28U-TCLNL-4	1.750	2.000	14.00	1.020
A28U-TCLNR-4	1.750	2.000	14.00	1.020
A32V-TCLNL-4	2.000	2.500	16.00	1.280
A32V-TCLNR-4	2.000	2.500	16.00	1.280

For inserts, see [pages 894 - 908, 993, 994, 996, 1009, 1018](#).

HARDWARE									
	Accepts Insert Series	Seat	Seat Screw	Clamp	Clamp Screw	Clamp Spring	Seat Screw Wrench	Clamp Screw Wrench	Coolant Nozzle
A16T-TCLNL-4	CN_43_	LSC42	SM50-107-10	DLM4	DLS4	DSP4	T20	L-W3	NZ62
A16T-TCLNR-4	CN_43_	LSC42	SM50-107-10	DLM4	DLS4	DSP4	T20	L-W3	NZ62
A20U-TCLNL-4	CN_43_	LSC42	SM50-107-10	DLM4	DLS4	DSP4	T20	L-W3	NZ62
A20U-TCLNR-4	CN_43_	LSC42	SM50-107-10	DLM4	DLS4	DSP4	T20	L-W3	NZ62
A24U-TCLNL-4	CN_43_	LSC42	SM50-122-50	DLM4	DLS4	DSP4	T20	L-W3	NZ104
A24U-TCLNR-4	CN_43_	LSC42	SM50-122-50	DLM4	DLS4	DSP4	T20	L-W3	NZ104
A28U-TCLNL-4	CN_43_	LSC42	SM50-122-50	DLM4	DLS4	DSP4	T20	L-W3	NZ104
A28U-TCLNR-4	CN_43_	LSC42	SM50-122-50	DLM4	DLS4	DSP4	T20	L-W3	NZ104
A32V-TCLNL-4	CN_43_	LSC42	SM50-122-50	DLM4	DLS4	DSP4	T20	L-W3	NZ104
A32V-TCLNR-4	CN_43_	LSC42	SM50-122-50	DLM4	DLS4	DSP4	T20	L-W3	NZ104

EXTERNAL TOOL HOLDER WITH T-TYPE CLAMPING SYSTEM FOR 55° DN__ INSERTS WITH INTERNAL COOLANT

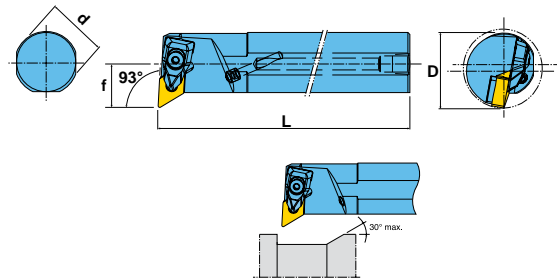

Designation	d	Dmin	L	f
A16T-TDUNL-3	1.000	1.500	12.00	0.750
A16T-TDUNR-3	1.000	1.500	12.00	0.750
A20U-TDUNL-3	1.250	1.750	14.00	1.000
A20U-TDUNR-3	1.250	1.750	14.00	1.000
A24U-TDUNL-4	1.500	2.000	14.00	1.130
A24U-TDUNR-4	1.500	2.000	14.00	1.130
A28U-TDUNR-4	1.750	2.250	14.00	1.250
A32V-TDUNL-4	2.000	2.750	16.00	1.500
A32V-TDUNR-4	2.000	2.750	16.00	1.500

For inserts, see [pages 909 - 919, 997, 998, 1011, 1019](#).

HARDWARE									
	Accepts Insert Series	Seat	Seat Screw	Clamp	Clamp Screw	Clamp Spring	Seat Screw Wrench	Clamp Screw Wrench	Coolant Nozzle
A16T-TDUNL-3	DN__33__	LSD32	S040085I	DLM3	DLS3	DSP3	T15	L-W2.5	NZ62
A16T-TDUNR-3	DN__33__	LSD32	S040085I	DLM3	DLS3	DSP3	T15	L-W2.5	NZ62
A20U-TDUNL-3	DN__33__	LSD32	S040085I	DLM3	DLS3	DSP3	T15	L-W2.5	NZ62
A20U-TDUNR-3	DN__33__	LSD32	S040085I	DLM3	DLS3	DSP3	T15	L-W2.5	NZ62
A24U-TDUNL-4	DN__43__	LSD43	SM50-122-50	DLM4	DLS4	DSP4	T20	L-W3	NZ104
A24U-TDUNR-4	DN__43__	LSD43	SM50-122-50	DLM4	DLS4	DSP4	T20	L-W3	NZ104
A28U-TDUNR-4	DN__43__	LSD43	SM50-122-50	DLM4	DLS4	DSP4	T20	L-W3	NZ104
A32V-TDUNL-4	DN__43__	LSD43	SM50-122-50	DLM4	DLS4	DSP4	T20	L-W3	NZ104
A32V-TDUNR-4	DN__43__	LSD43	S050090I	DLM4	DLS4	DSP4	T20	L-W3	NZ104

EXTERNAL TOOL HOLDER WITH T-TYPE CLAMPING SYSTEM FOR 120° HN__ INSERTS WITH INTERNAL COOLANT

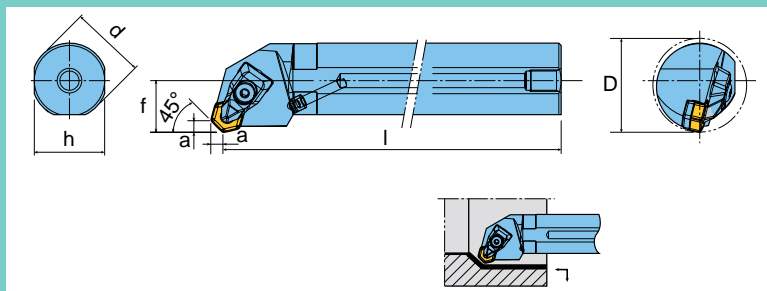

Designation	d	Dmin	L	f
A20U-THSNR-4	1.250	1.570	14.00	0.770
A24U-THSNL-4	1.500	2.000	14.00	0.900
A24U-THSNR-4	1.500	2.000	14.00	0.900
A32V-THSNL-4	2.000	2.480	16.00	1.390
A32V-THSNR-4	2.000	2.480	16.00	1.390

For inserts, see [pages 919, 920](#).

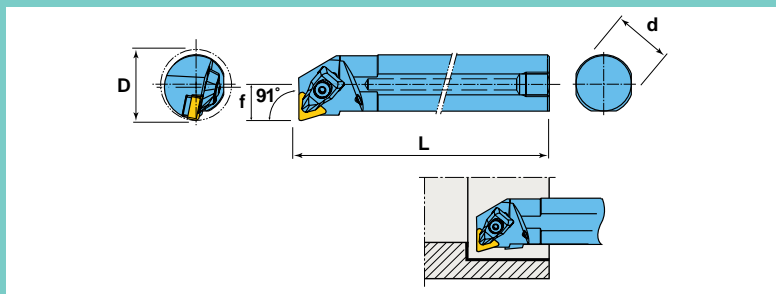

HARDWARE								
	Accepts Insert Series	Seat	Seat Screw	Clamp	Clamp Screw	Clamp Spring	Coolant Nozzle	Allen Wrench
A20U-THSNR-4	HN__43__	TSH42	SO40050I	DLM4	DLS4	DSP4	NZ62	L-W3
A24U-THSNL-4	HN__43__	TSH44	SO40050I	DLM4	DLS4	DSP4	NZ104	L-W3
A24U-THSNR-4	HN__43__	TSH44	SO40050I	DLM4	DLS4	DSP4	NZ104	L-W3
A32V-THSNL-4	HN__43__	TSH44	SO40050I	DLM4	DLS4	DSP4	NZ104	L-W3
A32V-THSNR-4	HN__43__	TSH44	SO40050I	DLM4	DLS4	DSP4	NZ104	L-W3

EXTERNAL TOOL HOLDER WITH T-TYPE CLAMPING SYSTEM FOR 60° TN__INSERTS WITH INTERNAL COOLANT



Designation	d	Dmin	L	f
A16T-TTFNL-3	1.000	1.250	12.00	0.640
A16T-TTFNR-3	1.000	1.250	12.00	0.640
A20U-TTFNL-3	1.250	1.500	14.00	0.765
A20U-TTFNR-3	1.250	1.500	14.00	0.765

For inserts, see [pages 932 - 944](#), [1003](#), [1004](#), [1015](#), [1021](#).

HARDWARE									
	Accepts Insert Series	Seat	Seat Screw	Clamp	Clamp Screw	Clamp Spring	Seat Screw Wrench	Clamp Screw Wrench	Coolant Nozzle
	TN__33_	LST32	SO40085I	DLM3	DLS3	DSP3	T15	L-W2.5	NZ62

EXTERNAL TOOL HOLDER WITH T-TYPE CLAMPING SYSTEM FOR TRIGON INSERTS WITH INTERNAL COOLANT

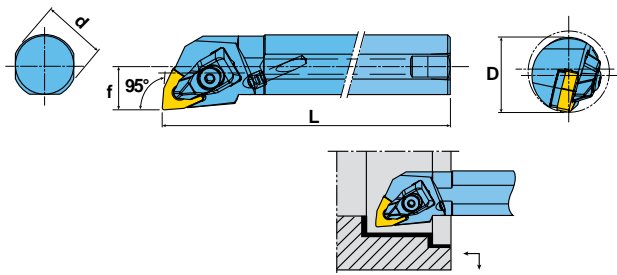

Designation	d	Dmin	L	f
A12S-TWLNL-3	0.750	1.000	10.00	0.500
A12S-TWLNLR-3	0.750	1.000	10.00	0.500
A16T-TWLNL-3	1.000	1.250	12.00	0.640
A16T-TWLNLR-3	1.000	1.250	12.00	0.640
A16T-TWLNL-4	1.000	1.280	12.00	0.640
A16T-TWLNLR-4	1.000	1.280	12.00	0.640
A20U-TWLNL-4	1.250	1.500	14.00	0.770
A20U-TWLNLR-4	1.250	1.500	14.00	0.770
A24U-TWLNL-4	1.500	1.780	14.00	0.890
A24U-TWLNLR-4	1.500	1.780	14.00	0.890

For inserts, see [pages 950 - 960, 1006, 1007, 1017](#).

HARDWARE									
	Accepts Insert Series	Seat	Seat Screw	Clamp	Clamp Screw	Clamp Spring	Seat Screw Wrench	Clamp Screw Wrench	Coolant Nozzle
A12S-TWLNL-3	WN_33_	-	-	DLM3	DLS3	DSP3	-	L-W2.5	NZ62
A12S-TWLNLR-3	WN_33_	-	-	DLM3	DLS3	DSP3	-	L-W2.5	NZ62
A16T-TWLNL-3	WN_33_	PSW32	SO40090I	DLM3	DLS3	DSP3	T15	L-W2.5	NZ62
A16T-TWLNLR-3	WN_33_	PSW32	SO40090I	DLM3	DLS3	DSP3	T15	L-W2.5	NZ62
A16T-TWLNL-4	WN_43_	PSW42	SM50-107-10	DLM4	DLS4	DSP4	T20	L-W3	NZ62
A16T-TWLNLR-4	WN_43_	PSW42	SM50-107-10	DLM4	DLS4	DSP4	T20	L-W3	NZ62
A20U-TWLNL-4	WN_43_	PSW42	SM50-107-10	DLM4	DLS4	DSP4	T20	L-W3	NZ62
A20U-TWLNLR-4	WN_43_	PSW42	SM50-107-10	DLM4	DLS4	DSP4	T20	L-W3	NZ62
A24U-TWLNL-4	WN_43_	TSW44	SM50-107-10	DLM4	DLS4	DSP4	T20	L-W3	NZ62
A24U-TWLNLR-4	WN_43_	TSW44	SM50-107-10	DLM4	DLS4	DSP4	T20	L-W3	NZ62

TOTURNSTM S-TCLNR/L-CH

EXTERNAL TOOL HOLDER WITH T-TYPE CLAMPING SYSTEM FOR 80° CERAMIC INSERTS

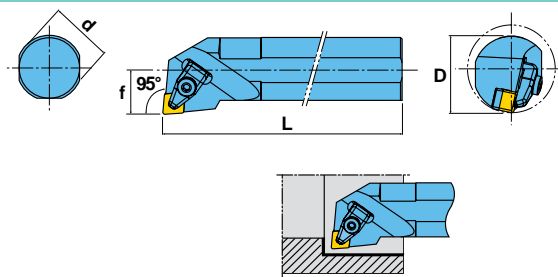

Designation	d	Dmin	L	f
S24U-TCLNL-4-CH	1.500	2.750	14.00	0.890
S24U-TCLNR-4-CH	1.500	2.750	14.00	0.890
S32V-TCLNL-4-CH	2.000	2.750	16.00	1.280
S32V-TCLNR-4-CH	2.000	2.750	16.00	1.280

For inserts, see [page 996](#).

EXTERNAL TOOL HOLDER WITH T-TYPE CLAMPING SYSTEM FOR 80° CERAMIC INSERTS

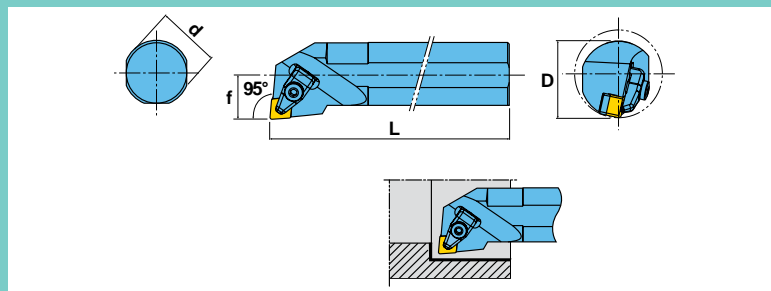

HARDWARE										
	Adaptíváncsok sorozata	hardvért leírás 2	hardvért leírás 3	hardvért leírás 4	hardvért leírás 5	hőlégtérpárológó	Seat Górnak Mészék	Clamp Górnak Mészék	hardware desc 9	hardware desc 10
S24U-TCLNL-4-CH	CNGX_45_CH	S48	BHM5X0.8X10	CCL4	CSC4	DSP5	L-W3	L-W4		
S24U-TCLNR-4-CH	CNGX_45_CH	S48	BHM5X0.8X10	CCL4	CSC4	DSP5	L-W3	L-W4		
S32V-TCLNL-4-CH	CNGX_45_CH	S48	BHM5X0.8X10	CCL4	CSC4	DSP4	L-W3	L-W4		
S32V-TCLNR-4-CH	CNGX_45_CH	S48	BHM5X0.8X10	CCL4	CSC4	DSP5	L-W3	L-W4		

Ingersoll



CUTTING TOOLS
CUTTING TOOLS

TECHNICAL INFORMATION.

Cutting Tools

GENERAL TECHNICAL INFORMATION

INSERT GRADES

INSERT GRADES - COATED CARBIDE AND CERMET

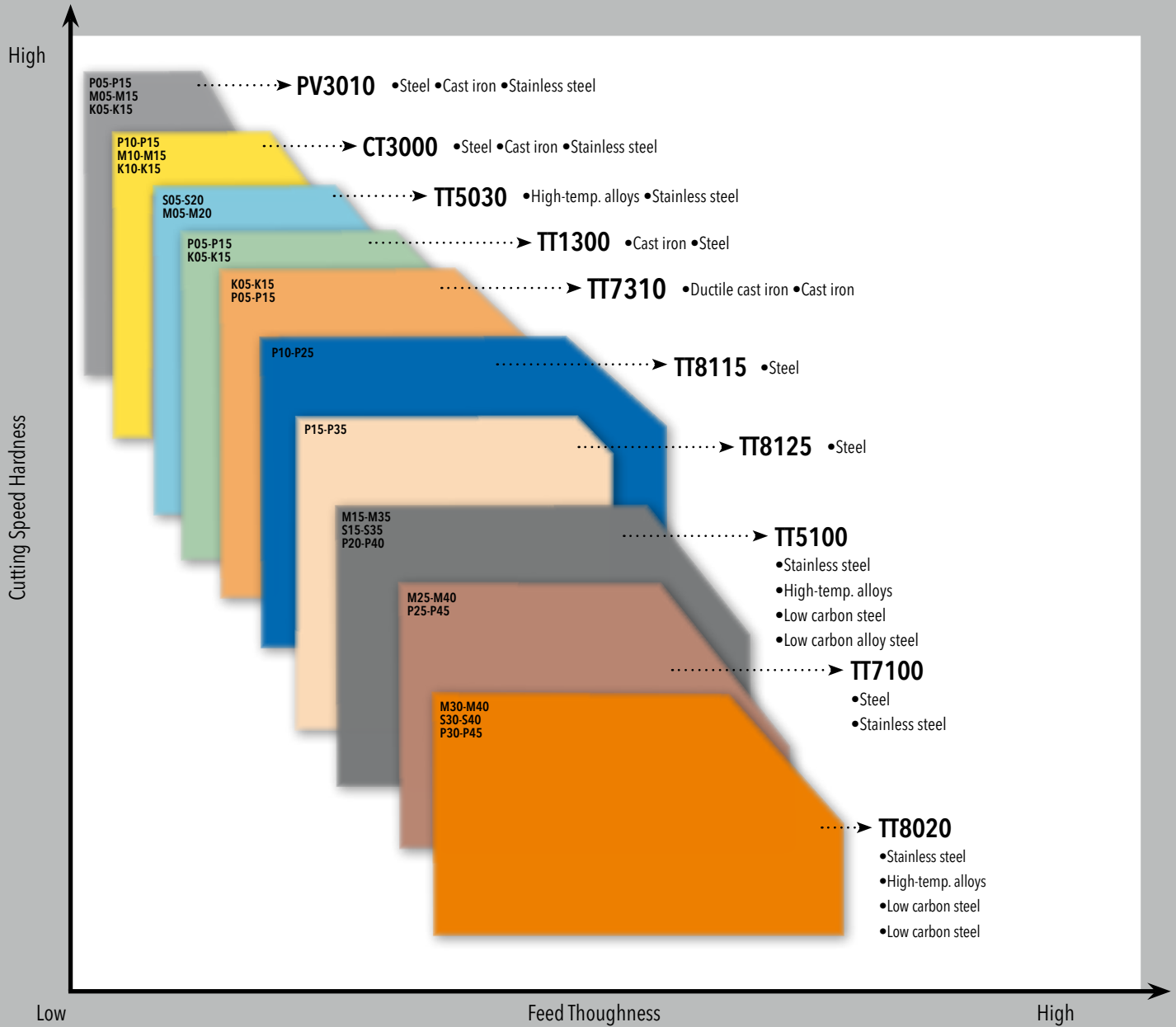

- **PV3010**: PVD coated Cermet, **CT3000**: uncoated Cermet
- **TT1300, TT7310, TT8115, TT8125, TT5100, TT7100, TT9215, TT9225, TT9235**: CVD coated carbide
- **TT5030, TT8020**: PVD coated

GENERAL TECHNICAL INFORMATION

INSERT GRADES

COATED CARBIDE, CERMET AND CARBIDE GRADES

Grades	ISO	Application
TT1300 CVD Coated	K05 – K15	<ul style="list-style-type: none"> For high speed turning of cast iron and steel. Thick aluminum oxide coating on a high wear resistant substrate. First choice for machining cast iron (Rough and Finish).
TT7310 CVD Coated	K05 – K15 P05 – P15	<ul style="list-style-type: none"> First choice for machining of ductile cast iron and cast iron. Special coating and tough substrate for the best wear resistance.
TT8115 CVD Coated	P10 – P25	<ul style="list-style-type: none"> High speed turning of steel. Very high wear resistance. First choice for finishing.
TT9215 CVD Coated	M10 – M25	<ul style="list-style-type: none"> For high speed cutting in stainless steel. Very high wear resistance. First choice for finishing, particularly in continuous cuts.
TT8125 CVD Coated	P15 – P35	<ul style="list-style-type: none"> Steel turning application. Very good combination of wear resistance and toughness. For finish to medium turning of steel.
TT9225 PVD Coated	M05 – M35	<ul style="list-style-type: none"> For a wide range of turning in stainless steel. Excellent combination of wear resistance & fracture toughness.
TT5030 PVD Coated	S05 – S20 M05 – M20	<ul style="list-style-type: none"> For a wide range of turning of high-temp alloys. Very hard submicron substrate with good fracture toughness.
TT9020 TT9030 PVD Coated	P15 – P30 S15 – S25 M20 – M30	<ul style="list-style-type: none"> For medium speed turning of stainless steel, exotic alloys and low carbon steel. Good combination of toughness and wear resistance.
TT5100 CVD Coated	M15 – M35 S15 – S35 P20 – P40	<ul style="list-style-type: none"> For a wide range of turning of sticky materials such as stainless steel and low carbon steel. Excellent chipping resistance and sticking resistance. For finish and medium machining on stainless steel and low carbon steel.
TT9235 CVD Coated	M30 – M45	<ul style="list-style-type: none"> For interrupted cutting of stainless steel. Ideal grade for unstable conditions or low cutting speeds. Very good fracture toughness.
TT7100 CVD Coated	M25 – M40 P25 – P45	<ul style="list-style-type: none"> Low speed turning of steel and stainless steel. Very tough substrate. For heavy roughing with interrupted cut.

GENERAL TECHNICAL INFORMATION

INSERT GRADES

COATED CARBIDE, CERMET AND CARBIDE GRADES

Grades	ISO	Application									
TT8020 PVD Coated	<table border="0"> <tr><td>M30</td><td>–</td><td>M40</td></tr> <tr><td>S30</td><td>–</td><td>S40</td></tr> <tr><td>P30</td><td>–</td><td>P45</td></tr> </table>	M30	–	M40	S30	–	S40	P30	–	P45	<ul style="list-style-type: none"> • For medium to low speed turning of stainless steel, exotic alloys and low carbon steel. • Toughest grade in turning product line. • For interrupted cut on stainless steel and exotic alloys.
M30	–	M40									
S30	–	S40									
P30	–	P45									
CT3000 CERMET	<table border="0"> <tr><td>P10</td><td>–</td><td>P15</td></tr> <tr><td>M10</td><td>–</td><td>M15</td></tr> <tr><td>K10</td><td>–</td><td>K20</td></tr> </table>	P10	–	P15	M10	–	M15	K10	–	K20	<ul style="list-style-type: none"> • Excellent surface finish turning of steel, stainless steel and cast iron. • Excellent wear resistance and low coefficient of friction
P10	–	P15									
M10	–	M15									
K10	–	K20									
PV3010 PVD Coated Cermet	<table border="0"> <tr><td>P05</td><td>–</td><td>P15</td></tr> <tr><td>K05</td><td>–</td><td>K15</td></tr> <tr><td>M05</td><td>–</td><td>M15</td></tr> </table>	P05	–	P15	K05	–	K15	M05	–	M15	<ul style="list-style-type: none"> • Turning of steel, stainless steel and cast iron with high surface quality. • Longer tool life.
P05	–	P15									
K05	–	K15									
M05	–	M15									
K10 Uncoated	<table border="0"> <tr><td>K10</td><td>–</td><td>K20</td></tr> <tr><td>S10</td><td>–</td><td>S20</td></tr> <tr><td>N10</td><td>–</td><td>N20</td></tr> </table>	K10	–	K20	S10	–	S20	N10	–	N20	<ul style="list-style-type: none"> • General turning of cast iron, exotic alloy and non-ferrous materials including aluminum and copper alloy. • Excellent wear resistant grade.
K10	–	K20									
S10	–	S20									
N10	–	N20									

CUTTING DATA FOR ISO TURNING

ISO	Material	Grades	ISO	Cutting speed SFM
P	Carbon steel	CVD		
		TT8115	P10 - P25	820 - 1310
		TT8125	P10 - P25	820 - 1150
		TT5100	P20 - P40	520 - 850
		TT7100	P35 - P45	390 - 650
		PVD		
		TT7220	P20 - P35	490 - 720
		TT8020	P30 - P45	460 - 650
		TT9020	P20 - P35	490 - 720
		TT9030	P15 - P35	850 - 920
		Cermet		
		CT3000	P05 - P15	980 - 1480
		PV3010	P05 - P15	780 - 1480
		Structural steel	CVD	
	TT7310		P05 - P15	590 - 920
	TT8115		P10 - P25	560 - 980
	TT8125		P10 - P25	490 - 920
	TT5100		P20 - P40	460 - 720
	TT7100		P35 - P45	390 - 590
	PVD			
	TT7220		P20 - P35	490 - 650
	TT8020		P30 - P45	430 - 590
	TT9020		P20 - P35	460 - 650
	TT9030		P15 - P35	560 - 750
	Cermet			
	CT3000		P05 - P15	820 - 1310
	PV3010		P05 - P15	820 - 1310
	High alloyed steel	CVD		
		TT7310	P05 - P15	520 - 820
		TT8115	P10 - P25	520 - 820
		TT8125	P10 - P25	460 - 790
		TT5100	P20 - P40	460 - 720
		TT7100	P35 - P45	330 - 460
		PVD		
		TT7220	P20 - P35	460 - 590
		TT8020	P30 - P45	330 - 520
TT9020		P20 - P35	390 - 590	
TT9030		P15 - P35	390 - 650	
Cermet				
CT3000		P05 - P15	720 - 1210	
PV3010		P05 - P15	720 - 1210	

The indicated values can vary due to clamping situation, machine stability and quality of material.

CUTTING DATA FOR ISO TURNING

ISO	Material	Grades	ISO	Cutting speed SFM
M	Stainless steel	CVD		
		TT5100	M15 - M35	490 - 650
		TT7100	M25 - M40	390 - 590
		TT9215	M10 - M20	720 - 920
		TT9225	M15 - M30	650 - 820
		TT9235	M25 - M40	590 - 790
		PVD		
		TT5030	M05 - M20	490 - 920
		TT8020	M30 - M40	330 - 590
		TT9020	M15 - 30	390 - 720
	TT9030	M10 - M30	490 - 790	
	Cermet			
	CT3000	P05 - P15	720 - 980	
	PV3010	P05 - P15	790 - 1050	
	High alloy stainless steel	CVD		
		TT5100	M15 - M35	390 - 620
		TT7100	M25 - M40	260 - 520
		TT9215	M10 - M20	590 - 820
		TT9225	M15 - M30	520 - 790
		TT9235	M25 - M40	460 - 650
PVD				
TT5030		S05 - S20	490 - 790	
TT8020		M30 - M40	330 - 520	
TT9020		M15 - 30	390 - 620	
TT9030	M10 - M30	390 - 620		
CVD				
CT3000	P05 - P15	650 - 980		
PV3010	P05 - P15	690 - 980		
K	Nodular gray cast iron	CVD		
		TT1300	K05 - K15	650 - 1480
		TT7310	K05 - K15	590 - 1250
		Cermet		
	CT3000	K05 - K15	590 - 1310	
	PV3010	K05 - K15	720 - 1540	
	Gray cast iron	CVD		
		TT1300	K05 - K15	590 - 1310
TT7310		K05 - K15	520 - 1250	
Cermet				
CT3000	K05 - K15	590 - 1150		
PV3010	K05 - K15	720 - 1310		
S	High temp. resisting alloys	CVD		
		TT5100	S15 - S35	130 - 260
		PVD		
		TT5030	S05 - S20	130 - 330
TT8020	S30 - S40	100 - 260		

The indicated values can vary due to clamping situation, machine stability and quality of material.

GENERAL TECHNICAL INFORMATION

CHIPBREAKERS

CHIPBREAKER IDENTIFICATION

CNM □ 432

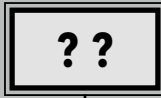

GEOMETRY AND APPLICATION INFORMATION

WS	Wiper insert, super finishing	
FA	Finishing accurate	
EA	Finishing, exotic materials	
FG	General finishing, tight chipbreaker	
FC	Finishing, sharp	
SF	Finishing, stainless steel	
MC	Medium, negative rake angle	
VF	Vibration free	
ML	Medium to light machining, high positive rake angle	
MP	Medium, positive rake angle	
SU	Medium, positive rake angle for super alloy	
PC	Medium machining	
MT	Medium roughing, tough rake angle	
GU	Medium roughing, tough rake angle	
WT	Wiper insert, medium roughing	
	No indication general use chipbreaker	
ET	Roughing, exotic materials	
RT	Roughing, tough rake angle	
RH	Roughing, high feed	
HT	Roughing, high feed	

GENERAL TECHNICAL INFORMATION

CHIPBREAKERS

NEGATIVE INSERTS

FOR FINISH APPLICATION

Depth of cut (inch)

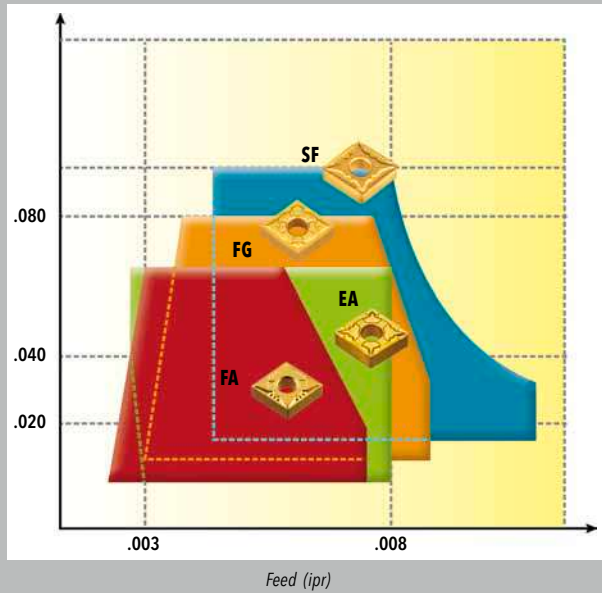

FOR MEDIUM APPLICATION

Depth of cut (inch)

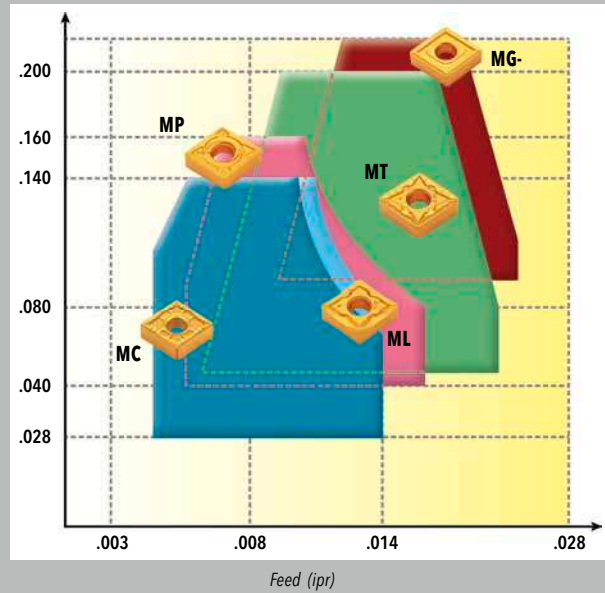

FOR ROUGH APPLICATION

Depth of cut (inch)

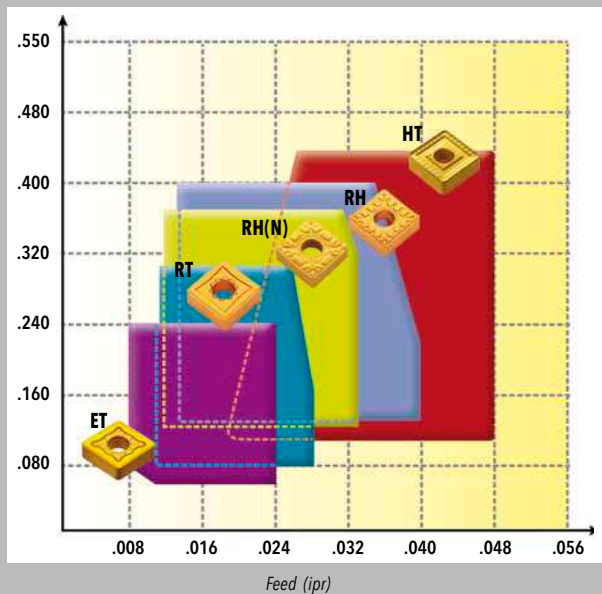

GENERAL TECHNICAL INFORMATION

CHIPBREAKERS

KNUX TYPE

Depth of cut (inch)

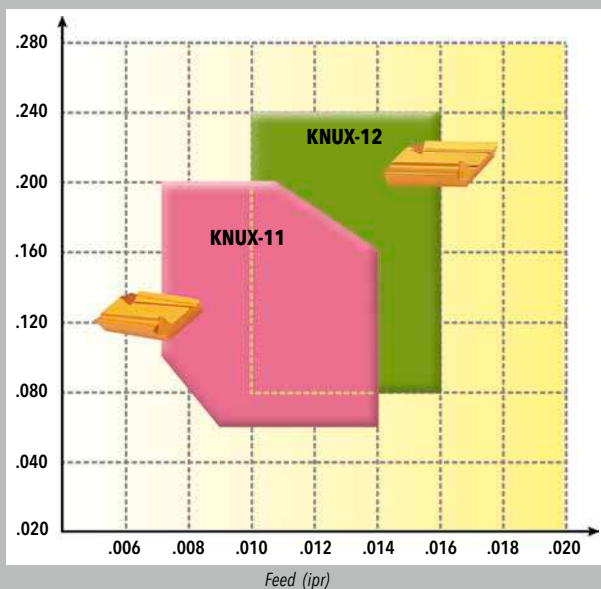

HNMG TYPE

Depth of cut (inch)

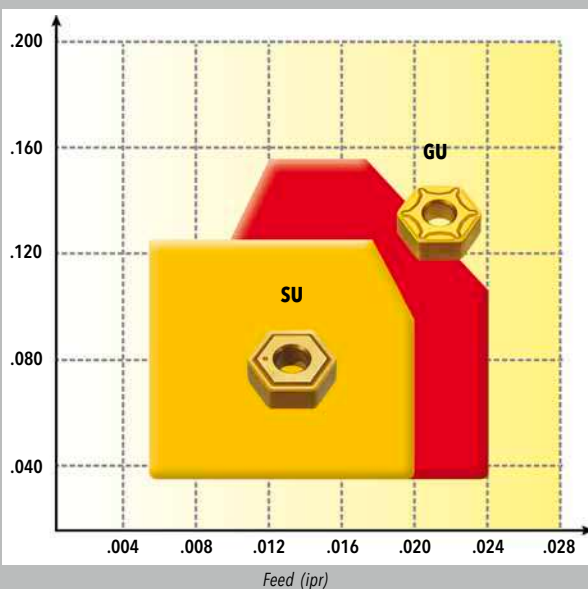

POSITIVE INSERTS

FOR FINISH TO MEDIUM APPLICATIONS

Depth of cut (inch)

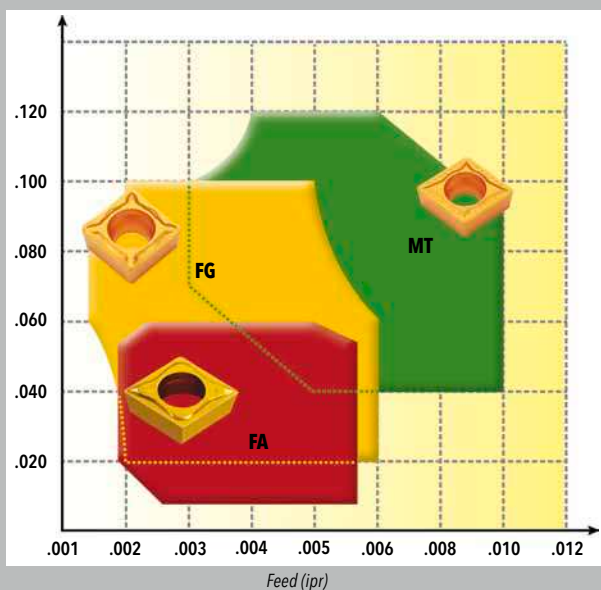

GENERAL TECHNICAL INFORMATION

CHIPBREAKERS

"WS" AND "WT" WIPER INSERTS FOR HIGH FEED TURNING

NEGATIVE INSERTS

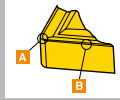

Chipbreaker Designation and Geometry				Application and Features
WS				<ul style="list-style-type: none"> For super finish applications Steel, cast iron and stainless steel Excellent chip control and low cutting forces
WT				<ul style="list-style-type: none"> For medium to medium rough applications Steel, cast iron and stainless steel Stable cutting and low cutting forces with high feed rate

POSITIVE INSERT

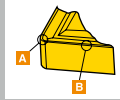

Chipbreaker Designation and Geometry				Application and Features
WT				<ul style="list-style-type: none"> For medium to medium rough applications Steel, cast iron and stainless steel Stable cutting and low cutting forces in high feed rate

NEGATIVE INSERTS

POSITIVE INSERTS

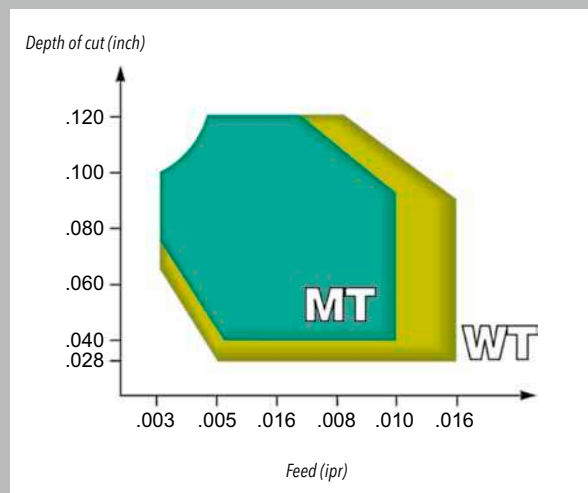
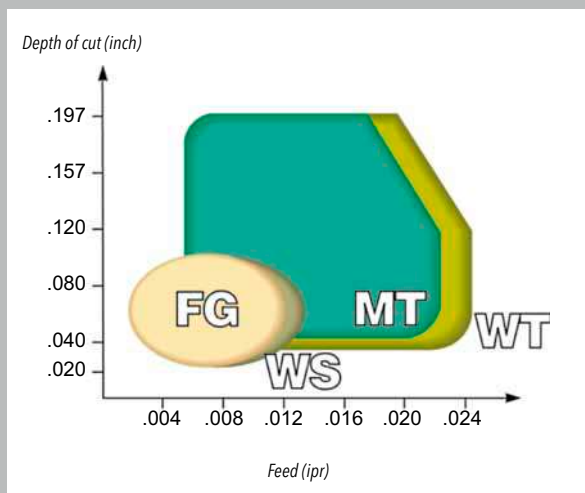

GENERAL TECHNICAL INFORMATION

CHIPBREAKERS



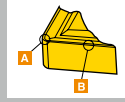





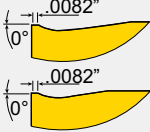

NEGATIVE INSERTS

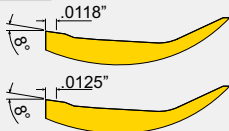

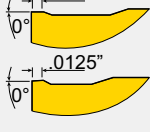
Chipbreaker Designation and Geometry		Application and Features
FC	 CNMG 43_ 	<ul style="list-style-type: none"> For finishing Steel, carbon steel, alloy steel Very good surface finish
FA	 CNMG 43_ 	<ul style="list-style-type: none"> For super finish applications Steel, stainless steel and heat resistant alloys Excellent chip control
EA	 CNMG 43_ 	<ul style="list-style-type: none"> For finish applications Exotic materials Excellent chip control in low feed and depth of cut
FG	 WNMG 33_ 	<ul style="list-style-type: none"> For finish and semi finish applications Steel, stainless steel and cast iron Low cutting forces
SF	 CNMG 43_ 	<ul style="list-style-type: none"> For finish applications Stainless steel and heat resistant alloys Low cutting forces
MC	 CNMG 43_ 	<ul style="list-style-type: none"> For medium applications / Pour les applications moyennes Steel and cast iron Strong rake geometry Excellent chip control on medium turning applications
VF	 DNMG 43_ 	<ul style="list-style-type: none"> For slender workpiece application Vibration free Steel and stainless steel High positive rake geometry to minimize cutting force
ML	 CNMG 43_ 	<ul style="list-style-type: none"> For medium light applications Stainless steel, steel and aluminum Very high positive rake geometry to optimize machining in stable conditions
MP	 CNMG 43_ 	<ul style="list-style-type: none"> For medium applications Steel and stainless steel High positive rake geometry to optimize machining in stable conditions
PC	 CNMG 43_ 	<ul style="list-style-type: none"> For medium application Steel, carbon steel, alloy steel Positive geometry
MT	 WNMG 43_ 	<ul style="list-style-type: none"> For medium rough applications Steel, cast iron and stainless steel Tough rake angle for general use

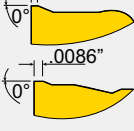

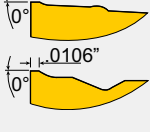
GENERAL TECHNICAL INFORMATION

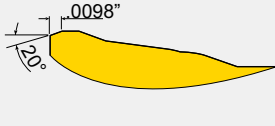
CHIPBREAKERS

MG-		CNMG 43_ 	<ul style="list-style-type: none"> For medium rough applications Steel and cast iron Strong rake geometry Suitable for general machining
ET		CNMG 43_ 	<ul style="list-style-type: none"> For rough applications of exotic materials Low cutting force Wide chip control range of roughing
RT		CNMM 64_ 	<ul style="list-style-type: none"> For rough applications Steel and cast iron Very strong rake geometry
RH(N)		CNMM 64_ 	<ul style="list-style-type: none"> For high feed roughing applications Steel, stainless steel and cast iron Very strong rake geometry
RH		CNMM 64_ 	<ul style="list-style-type: none"> For high feed roughing applications Steel, stainless steel and cast iron Very strong rake geometry
HT		SNMM 64_ 	<ul style="list-style-type: none"> For heavy roughing application Very strong cutting edge with negative rake angle Geometry designed to generate less heat in spite of negative insert

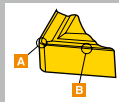
HNMG TYPE INSERTS

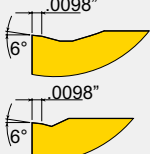

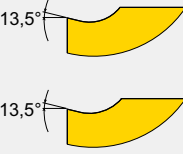







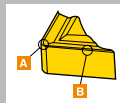

Chipbreaker Designation and Geometry		Application and Features
GU	 HNMG 	<ul style="list-style-type: none"> For medium applications For general turning of steels and cast irons Strong rake geometry
SU	 HNMG 	<ul style="list-style-type: none"> For exotic materials Stainless steels, super alloys, low carbon steels, low carbon alloy steels Sharp geometry to minimize built-up edge

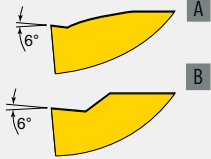
GENERAL TECHNICAL INFORMATION

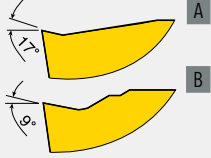
CHIPBREAKERS

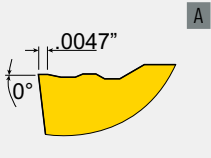

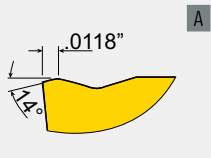
POSITIVE INSERTS

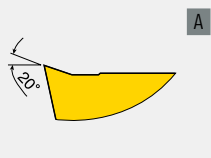

Chipbreaker Designation and Geometry		Application and Features
FA	 <p>DCMT 32.5_</p>  <p>A</p>  <p>B</p>	<ul style="list-style-type: none"> • For super finish applications • Very tight chipbreaker • Excellent chip control
FG	 <p>CCMT 32.5_</p>  <p>A</p>  <p>B</p>	<ul style="list-style-type: none"> • For finish to medium light applications • Steel and stainless steel • Low cutting forces • Excellent chip control
MT	 <p>CCMT 32.5_</p>  <p>A</p>	<ul style="list-style-type: none"> • For medium to medium rough applications • Steel, stainless steel and cast iron • Negative rake geometry for general use
CMX-	 <p>RCMX 1204</p>  <p>A</p>	<ul style="list-style-type: none"> • For high feed roughing applications • Steel, stainless steel and cast iron • Strong rake geometry
FL	 <p>CCGT 43_</p>  <p>A</p>	<ul style="list-style-type: none"> • For finish to medium applications • Aluminum • Very high positive rake geometry to minimize built-up-edge

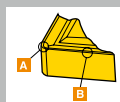

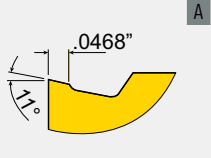

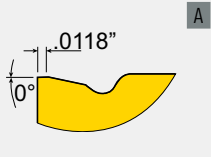

KNUX TYPE INSERTS

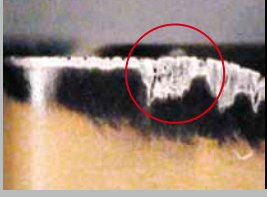

Chipbreaker Designation and Geometry		Application and Features
11	 <p>KNUX 333_</p>  <p>A</p>	<ul style="list-style-type: none"> • For light to medium applications • Steel and stainless steel • Positive rake geometry to minimize cutting forces • Excellent chip control
12	 <p>KNUX 333_</p>  <p>A</p>	<ul style="list-style-type: none"> • For light to medium rough applications • Steel and stainless steel • Strong rake geometry • Wide chip control range

GENERAL TECHNICAL INFORMATION

INSERTS FAILURE TROUBLE SHOOTING

		Cause
Crater Wear		<ul style="list-style-type: none"> Excessive cutting speed or feed rate (alloy steel and over 0.3% carbon steel) Workpiece material contains high hardness chemical elements (tool steel, die steel)
Flank Wear		<ul style="list-style-type: none"> Excessive cutting speed (alloy steel and over 0.3% carbon steel) Workpiece material contains very hard chemical elements (tool steel, die steel) Increase cutting speed if abnormal flank wear caused by very slow cutting speed.
Deformation		<ul style="list-style-type: none"> Excessive cutting speed or feed rate
Chipping		<ul style="list-style-type: none"> Excessive feed rate Interrupted cut
Notching		<ul style="list-style-type: none"> Machining of scale parts High work hardening materials
Built-up edge		<ul style="list-style-type: none"> Slow cutting speed Sticky materials
Mechanical Fracture		<ul style="list-style-type: none"> Excessive feed rate of interrupted cut
Thermal Cracking		<ul style="list-style-type: none"> Thermal shock repeatedly (interrupted cut)

GENERAL TECHNICAL INFORMATION

INSERTS FAILURE TROUBLE SHOOTING

Solution

- Reduce cutting speed or feed rate or use more wear resistant grade
- Use coolant
- Use more positive rake geometry
- Reduce cutting speed or feed rate or use more wear resistant grade
- Use coolant

- Reduce cutting speed or feed rate or use more wear resistant grade
- Use coolant
- Use more positive rake geometry
- Reduce cutting speed or feed rate or use more wear resistant grade
- Use coolant

- Reduce cutting speed or feed rate or use more wear resistant grade
- Use coolant
- Use more positive insert geometry

- Reduce feed rate
- Use tougher grade
- Use more positive insert geometry
- Remove coolant completely or apply coolant correctly

- Use tougher grade
- Use more positive rake geometry
- Increase lead angle
- Use tougher grade
- Use more positive rake geometry
- Increase lead angle

- Increase cutting speed
- Use more positive rake geometry

- Use more positive rake geometry
- Use tougher grade

- Use tougher grade
- Use stronger insert geometry
- Reduce feed rate
- Remove coolant completely or apply coolant correctly
- Increase cutting speed

- Use tougher grade
- Use more positive rake geometry
- Reduce feed rate
- Remove coolant completely or apply coolant correctly

Change Grade

← Harder

PV3010 > CT3000 > TT5030 > TT1300 > TT7310 > TT8115 > TT8125 > TT5100 > TT7100 > TT8020

Change Grade

← Less ASB*
Less Heat

FA	FG		ET			
FC	ML	MP	MT	MC	MG-	RT
	WS	VF	WT			RH
	SF		PC			
	EA					

* ASB = Built-up edge

Change Grade

Tight → Open

FA	FG	MC	ML	MP	MT	MG-	ET	RT	RH
EA	WS			VF	WT				
FC	SF				PC				

GENERAL TECHNICAL INFORMATION

TOTURN™ CERAMIC INSERTS

PHYSICAL PROPERTIES - CERAMIC GRADES

Grade		AW20	AB20	AB30	AS10	SC10	AS20
Composition		Al ₂ O ₃ - ZrO ₂	Al ₂ O ₃ - Ti(C,N)	Al ₂ O ₃ - TiC	Si ₃ N ₄	CVD- Si ₃ N ₄	Si ₃ N ₄ - TiN
Density (g/cm ³)		4,05	4,30	4,25	3,22	3,22	3,50
Hardness	HRA	94,0	94,5	94,5	93,6	93,6	93,0
	Vickers	1,800	2,050	2,050	1,700	1,700	1,500
Bending Strength (MPa)		600	650	700	900	900	1,000

APPLICATION DIAGRAM OF CERAMIC GRADES

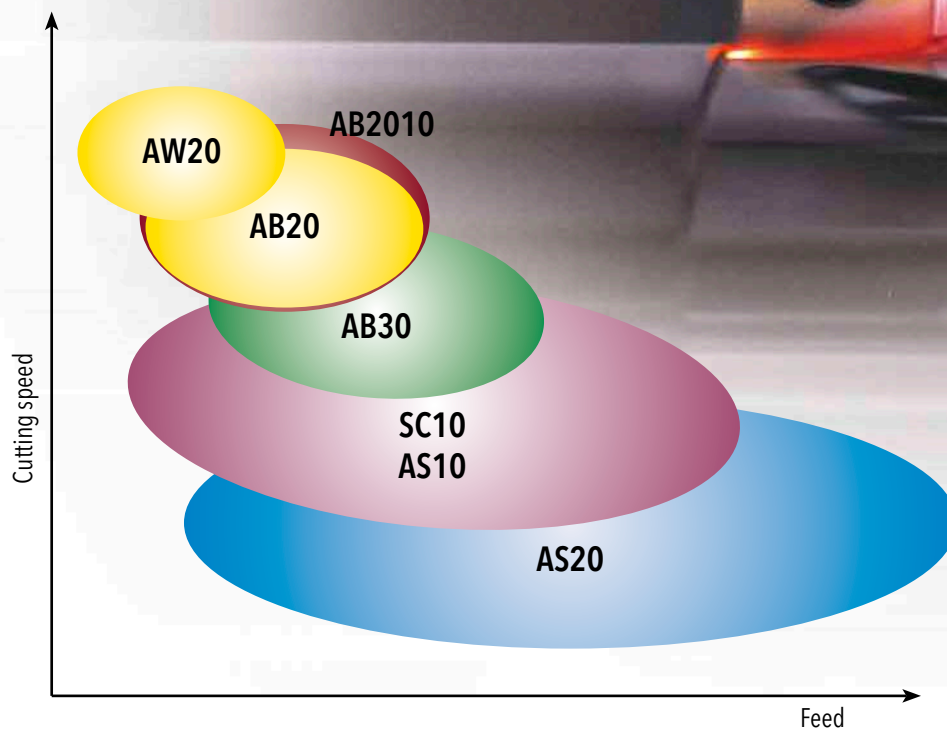

GENERAL TECHNICAL INFORMATION

TOTURN™ CERAMIC INSERTS

AW20 (Al₂O₃+ZrO₂)



- Excellent wear resistant grade with high chemical stability and temperature resistance.
- For high speed continuous turning of cast iron.
- For finishing applications on hardened steels and other hard materials.

AB2010 (Al₂O₃+TiCN) with TIN PVD Coat



- Excellent wear resistance with extended tool life compared to uncoated ceramic grades.
- TIN coating makes it easy to identify used corners.
- Successful application of ceramic inserts on hard materials can provide significant cost advantage compared to CBN.
- The combination of this ceramic grade with TIN PVD coating provides improved wear resistance and fracture toughness.
- Application area is in the finish machining of hardened steels and cast iron.

AB20 (Al₂O₃+TiCN)

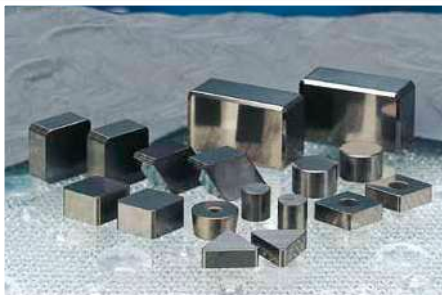

- High wear resistant grade with excellent cutting edge stability.
- For high speed continuous turning of hardened steels and other hard materials.
- For cast iron finishing applications.

GENERAL TECHNICAL INFORMATION

TOTURN™ CERAMIC INSERTS

AB30 (Al₂O₃+TiC)



- Mixed ceramic with good toughness and wear resistance.
- For finishing and roughing applications of hard steels, hard materials and cast iron finishing and roughing applications.
- Can be applied for interrupted cutting.

AS10 (Si₃N₄)

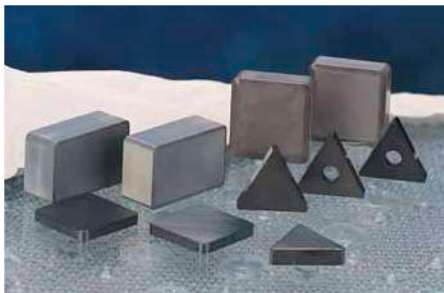

- High wear resistant grade with very good toughness and thermal shock resistance.
- For roughing to finishing cast iron.
- Wet and dry cutting

SC10 (AS10+CVD)

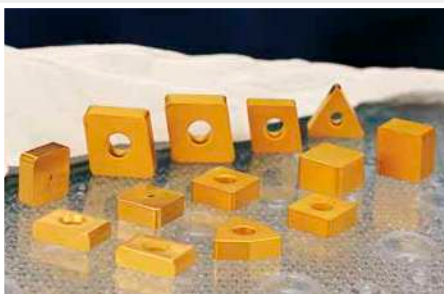

- Excellent wear resistant grade with very good toughness and thermal shock resistance
- For roughing to finishing cast iron.
- Wet and dry cutting

AS20 (Si₃N₄)

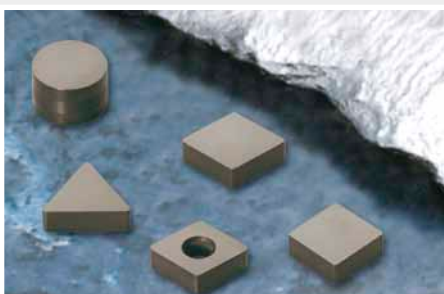

- Very tough Si₃N₄ ceramic grade with high cutting edge stability.
- For roughing to finishing applications of nickel based high temperature alloys.
- Wet and dry cutting.

GENERAL TECHNICAL INFORMATION



RECOMMENDED CUTTING CONDITIONS

Materials	Grade Type	AW20	AB2010	AB20	AB30	SC10	AS10	AS20
	V,f	Cutting Speed: V (SFM), Feed: f (IPR)						
High temp. alloy (200 - 400 HB)	V f	-	-	-	-	-	-	330 - 1150 .004 - .012
Hardened steel (46 - 65 HRC)	V f	330 - 820 .004 - .006	160 - 890 .004 - .008	160 - 890 .004 - .008	160 - 850 .004 - .010	-	-	-
Chilled cast iron (400 HB)	V f	-	160 - 720 .002 - .008	160 - 650 .002 - .008	160 - 490 .002 - .008	-	-	-
Gray cast iron (180 - 230 HB)	V f	1300 - 3280 .002 - .008	980 - 2950 .004 - .012	980 - 2620 .004 - .012	980 - 2620 .004 - .002	980 - 3280 .008 - .031	980 - 3620 .008 - .031	-
Ductile cast iron (200 - 240 HB)	V f	9800 - 1970 .002 - .006	980 - 1970 .004 - .008	980 - 1640 .004 - .008	250 - 1640 .004 - .016	250 - 1970 .008 - .024	250 - 1640 .008 - .024	-

EDGE PREPARATIONS FOR CERAMIC INSERTS

1. Common Style (no designation)

Grade	Land specification	
	Width (in)	Angle (°)
AB2010, AB20, AB30, SC10, AS10, AS20, AW20	.008	25
	.008	20

2. Others (other edge designs)

Designation	Land specification	
	Width (in)	Angle (°)
T2	.004	30
T3	.006	30
T4	.008	30
T5	.012	30
T6	.004	20
T7	.008	20

3. Standard honing size of E type edge preparation is .0015". (only honing without T-land)

4. Many special edge preparations like "Double Land" or "S" can be made upon request.

GENERAL TECHNICAL INFORMATION

TOTURN™ CBN INSERTS

KB50, TB650, KB90, KB90A

PHYSICAL PROPERTIES

Grade	KB50	TB650	KB90	KB90A
TRS (Gpa)	0,9 - 1,1	1,0 - 1,1	1,1 - 1,2	1,1 - 1,2
Hardness (Gpa)	29 - 31	30 - 32	39 - 42	35 - 38

KB50

- High wear resistant cubic boron nitride with low CBN content.
- For precision machining of hardened steels (harder than 45HRC) such as hot and cold working tool steels, die steels, case hardened steels, carburized iron and high speed steel.
- For continuous cut.
- For turning

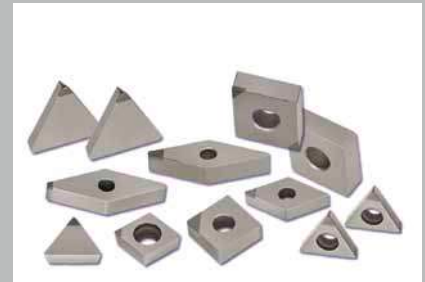

TB650

- High wear resistant cubic boron nitride with low CBN content.
- Designed for finishing to roughing applications on hardened steels (harder than 45HRC).
- Can be applied to light interrupted cutting applications.
- For turning / Pour tournage



KB90

- Tough cubic boron nitride with high CBN content.
- For high speed machining of cast iron.
- Suitable for machining cemented tungsten carbide, sintered metal and heavy alloys.
- Excellent for interrupted cutting of hardened steel.

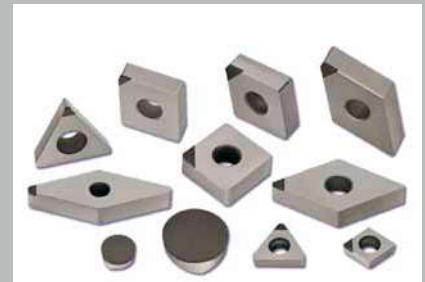

KB90A

- Solid CBN with excellent impact resistance.
- For high speed machining of cast iron.
- Can be applied for rough to medium machining of hardened steel.



GENERAL TECHNICAL INFORMATION



RECOMMENDED CUTTING CONDITIONS

Materials	Grade	KB50	TB650	KB90	KB90A
	V, f, ap	Cutting Speed: V (SFM), Feed: f (IPR), Depth of cut: ap (inch)			
Hardened steel (46 - 68 HRC)	V	330 - 820	260 - 650	200 - 490	200 - 490
	f	.004 - .007	.004 - .009	.004 - .012	.004 - .012
	ap	.004 - .020	.004 - .008	.008 - .039	.008 - .080
Chilled cast iron (400 HB)	V			260 - 490	260 - 490
	f			.004 - .012	.004 - .012
	ap			.008 - .060	.008 - .080
Gray cast iron (180 - 230 HB)	V			1640 - 3930	1640 - 3930
	f			.004 - .012	.004 - .012
	ap			.004 - .080	.004 - .080
Sintered metal	V			330 - 660	
	f			.002 - .008	
	ap			.008 - .040	
DCI rolled, HSS roll	V	980 - 1970	650 - 1640		
	f	.002 - .008	.002 - .008		
	ap	.008 - .020	.008 - .020		
High temp. alloy (200 - 400 HB)	V			330 - 980	330 - 980
	f			.002 - .008	.002 - .008
	ap			.004 - .020	.004 - .080

EDGE PREPARATIONS FOR CBN INSERTS

1. Common style (no designation)

Grade	Land specification		
	Width (in)	Angle (°)	Honing (in)
KB50, TB650	.005	20	.0006
KB90	.005	20	-
KB90A	.008	20	.0006

Technical information for CBN inserts

- CNMA 120408 LN : Regular Size CBN Tip
- CNMA 120408 LS : Small Size CBN Tip
- CNMA 120408 LS2 : Small Size CBN Tip with two corners
- RCGX 090300 FT : Full Top CBN
- CNMN 090308 SD : Solid CBN

GENERAL TECHNICAL INFORMATION

TOTURN™ PCD INSERTS

KP500, KP300, KP100

PHYSICAL PROPERTIES

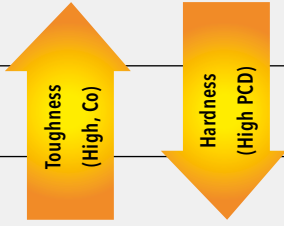
Grade	Feature	PCD (μm)	TRS (GPa)	Hardness (GPa)
KP100		4	2,0 - 2,2	80 - 100
KP300		10	1,8 - 2,0	90 - 110
KP500		25	1,0 - 1,2	100 - 120

KP500

- Super abrasion resistant grade.
- Designed for fine finishing cuts with less or no interruptions.
- For high Si aluminum alloy ($Si > 12.2\%$), metal matrix composite and sintered tungsten carbide.

KP300

- This KP300 is for general machining.
- Well combined wear resistance and toughness.
- For low to medium Si aluminum alloy ($Si \leq 12.2\%$), copper alloy and non-ferrous metal.

KP100

- Low content poly-crystalline diamond with fine grain.
- High edge strength and good surface finish.
- For plastic, wood and pure aluminum.

INGERSOLL

GENERAL TECHNICAL INFORMATION

GRADES

GRADES COMPARISON TABLE - COATED CARBIDE

ISO	INGERSOLL	Sandvik	Walter	SECO	Kennametal	Mitsubishi	Sumitomo	Tungaloy	Kyocera	Valenite	Korloy	Iscar
P	TT8115	GC4205 GC4215 GC4015	WPP10 WAP10	TP1000 TP1500	KCP05 KCP10 KC9110	UE6105 UE6110	AC1000 AC700G	T9005 T9015	CA5505 CA5515 CR7015	VP5515 VP5615	NC3010	IC8150 IC9150
	TT8125 TT5100	GC4225 GC4025	WPP20 WAP20	TP2000 TP2500	KCP25 KC9125	UE6020	AC820P AC2000	T9025	CA5525 CR7025	VP5525 VP5625	NC3015 NC3120 NC3020	IC8250 IC9250
	TT7100	GC4235 GC4035	WPP30 WAP30	TP3000 TP40	KCP35 KCP40 KC9040	UE6035 UH6400	AC830P AC3000	T9035	CA5535 CR9025	VP5535 VP5635	NC3030 NC500H	IC8350 IC9350
M	TT9215	GC2015	WAM10	TM2000 TP200	KCM15	US7020 VP05RT	AC610M EH10Z	T6020	CA6515	VP8515	PC8110 NC9020	IC907
	TT9225	GC2025	WAM20	CP500	KCM25	US735	AC630M AC304	T6030	CA6525	VP8525	NC9025	IC9300
	TT9235 TT8020	GC2035	WAM30	TM4000 TP400	KCM35	UH6400	AC3000		PR630	VP8535	PC9030 PC230	IC3028
K	TT1300	GC3205	WAK10	TK1000	KCK05 KC9315	UC5105	AC410K AC300G	T5105 T5010	CA4010	VP1505	NC305K	IC5005 IC4028
	TT7310	GC3210	WAK20	TK2000	KCK15 KC9325	UC5115	AC700G	T5115 T5020	CA4115 CA4120	VP1510	NC6110 NC6010	IC5010
		GC3215			KCK20		AC2000	T5125			NC315K	
S, H	TT5030	GC1105		TS2000 TS2500	KC5510	VP05RT VP10RT	AC510U	AH110	PR1005 PR930	VP1510 VPUS10	PC8110	IC807 IC907
	TT9030	GC1125	WSM30	CP500	KC5525	VP15TF	AC520U	AH120	PR1025 PR1125	VP7615	PC9530	IC808 IC908

GENERAL TECHNICAL INFORMATION

GRADES

UNCOATED CARBIDE

ISO Classification	INGERSOLL	SANDVIK	SECO	SUMITOMO	MITSUBISHI	TOSHIBA	ISCAR	
P	P01	CT3000	S1P	FIF		NS530	IC20N	
	P10	P10	S10T	S1F, S10M	ST10P	STi10T	TX10D TX10S	
	P20	P20	SMA	S25M	ST20E	STi20	TX20 TX25 UX25	IC70
	P30	P30	S30 SM30	375 S35M	A30N A30		TX30 UX30	IC50M
	P40	P40	S6 R4, SMA	S60M	ST40E		TX40	IC54
M	M10	M10	S1P, H10A	SM10	U10E		TU10	IC70
	M20	M20	H13A	HX, S25M	U2	UTi20T	TU20 / UX25	IC08
	M30		H10F	HX, S35M	A30, A30N	UTi20T	UX30	
	M40	M40	R4	S60M	A40		TU40	IC28
K	K01	UF1	H1P		H2	HTi05T	TH03	IC07
	K10	K10	HM H10, H10A	HX	H1 EH10	HTi10	G1F H10T TH10	IC20
	K20	K20	H13A	H15 HK 883	EH20 G10E	HTi20T	G2F KS20 G2	IC10
	K30	K30			G3			

CERMET

ISO Classification	INGERSOLL	SANDVIK	KYOCERA	SUMITOMO	MITSUBISHI	TOSHIBA	DIJET	KENNAMETALL	HITACHI	ISCAR	
P	P01	PV3010 PV3030 CT3000	CT5005 CT5015	TN30 PV30	T110A	NX1010 AP25N	NS520 AT520 GT520	LN10 CX50	KT125	CH350	IC20N
	P10	PV3010 PV3030 CT3000	CT5015	TN60 PV60 TN6020 PV7020	T1200A T2000Z	NX1010 NX2525 AP25N UP35N	NS520 AT520 AT530	LN10 CX50 NIT CX75	KT315 KT175 HT2	CH350 CH550 CH7030 CZ1025	IC20N
	P20	PV3010 CT3000 CT5000	GC1525	TN6020 TN90 TN100M PV90 PV7020	T1200A T2000Z T3000Z	NX2525 NX4545 UP35N	NS530 AT530 GT530	CX50 CX75 CX90 NAT	PS5	CH7030 CH7035 CZ1025 CZ25	IC20N IC30N
	P30	CT5000	CT530		T130A T3000Z	NX4545	NS530 NS540 NS740	CX90 CX99 SUZ		CH7035 CZ25	IC30N
M	M10	PV3010 PV3030 CT3000	CT525	TN60 PV60 TN6020 PV7020	T1200A T2000Z	NX2525	NS520 AT530 GT530	LN10	KT315 KT125	CH550 CH7030 CZ1025	IC20N
	M20	PV3010 PV3030 CT3000 CT5000	GC1525		T1200A T2000Z T3000Z	NX2525	NS530	CX50 CX75 NIT	KT175 HT2 PS5	CH7030 CH7035 CZ1025 CZ25	IC20N IC30N
	M30	CT5000	CT530	TN30 PV30		NX4545	NS540 NS740	CX75 CX90 CX99 SUZ		CH7035 CZ25	IC30N
K	K01	PV3010 PV3030 CT3000	CT5015 CT515		T110A	NX1010 AP25N	NS520 AT520 GT520	LN10		CH550	IC20N
	K10	PV3030 CT3000		PN60 PV60 TN6020 PV7020	T110A	NX2525 AP25N	NS530 AT530 GT530	LN10	KT315 HTX	CH7030 CH7035 CZ1025 CZ25	IC20N
	K20	CT5000				NX2525 AP25N		NIT	KT315	CH7035 CZ25	

INGERSOLL

GENERAL TECHNICAL INFORMATION

GRADES

CERAMIC

Application		INGERSOLL	ISCAR	KENAMETAL	KYOCERA	NTK	SANDVIK	SUMITOMO	TOSHIBA	SSANGYOUNG
Cast iron	Finishing	AW20	IN11	KW80	KA30	HW2 HC1	CC620			SZ200
	General	AB30	IN23	KY1615	A65	HC2 HC5 HC6	CC650	NB90S NB90M	LX21	ST100
	Roughing	AS500 AS10 SC10	IS8 IS80	KY1310 KY3000 KY3500 KY3400	KS500 KS6000	SX1 SX8 SP2	CC690 CC6090 GC1690	NS260 NS260C	FX105 CX710	SN26 SN300 SN500
Hardened steel		AB2010 AB20	IN22	KY4300	A66N	HC4 XC4	CC650	NB100C	LX11	ST300
Heat resistant alloy		AS20	IS16	KY2000 KY2100 KY1540		WA1	CC670		WG300	SN700

CBN

Application		INGERSOLL	KENAMETAL	KYOCERA	NTK	SANDVIK	SECO	SUMITOMO	TOSHIBA
Cast iron	Finishing	TB850	KD120	KBN65B	B20	CB7050	CBN20	BN500	BX930
	General	KB90 KB90A	KD120	KBN410 KBN900	B22	CB50	CBN300	BN600 BN700	BX950
Hardened steel	Finishing	KB50	KD050 KD120 KB1615	KBN10B KBN10N	B24	CB7020	CBN100	BNX10 BNC80 BNC150	BX310
	General	TB650	KB1340 KB5625	KBN25B KBN525 KBN25N	B26	CB20	CBN150 CBN200	BNX20 BN250 BNX25 BN300 BN350 BNC200 BNC300	BX330 BX360 BX380 BXC5

PCD

Grade	INGERSOLL	KENAMETAL	KYOCERA	NTK	SANDVIK	mitsubishi	SUMITOMO	TOSHIBA
Fine	KP100	PD100	KPD001			PD10	DA2200 DA90	DX180
Medium	KP300	KD300	KPD010	PD1	CD10	PD20	DA150	DX160 DX140
Coarse	KP500	KD1415	KPD025			PD30	DA200	DX120

GENERAL TECHNICAL INFORMATION

CHIPBREAKERS

CHIPBREAKER COMPARISON TABLE

P M K N S H

Description	Ingersoll	Kyocera	Sandvik	Kennametal	Seco	Walter	Valenite	Mitsubishi	Sumitomo	Tungaloy	Korloy	Iscar		
For Steel	Double Sided	WS	WP	WF, WL	FW	W-MF2	NF	W3	SW	LUW	AFW	LW		
		WT	WQ	WMX, WM	MW	W-M3	NM	W6	MW	GUW	ASW	VW, HW	WG	
		FA	GP, DP		FF FS	FF1		F2	FH	FL, FA	TF	HU	SF	
		FG		QF	FP FN	MF2	MF3		SH	SU	TSF, ZF ZM, TS, NS, NM	VG, HF, GF	NF	
		FC	CQ, CJ	PF, LC			NS6		FY, SA	LU		VF, VF, HC		
		VF		K		95			ES	GX, HM	S			
		ML	A3, AH	GP-	GP-K, MS- MS GP			NS4 NS5, G1	FJ, SY		CB, 17	HA	12 PP	
	SU		MX-SM, SR, 23					MJ	UP	SA				
	MP		QM	P	MF3	NM4	M2				HS, GS	TF VL		
	MC	GS	SM	MN	MR3	NM4				AS	HC			
	PC	PS	PM		M3	NM6		MP, MV	GU	TM	VM			
	MT	HS CS		MP			NS8	M3	MA	UX, UG	HM, GM	GN		
	MG-	MG- C		UN	M4	MG-			UZ	38 DM, MG- 33, 37	B20, B25	MG-		
	Single Sided	RT	ZS, GC GT, PT PH, HT	PR HM	UM RN, MG-	M5 MR7	NM5, NM7 NM6, NM9	R3	MH, GJ GH HAS, HDS	MU, MX	TH	HR, GR	NR	
RH		PX HX	PR QR MR	RM RP	R6, RR9 R5, R4, 37 RR6	NR6 NR5, NR8 NR7	R6	HZ HA HH	MP HG HP	TRS 57	GH	RP NM		
HT			HR, 31	RH	R8, 56, 57 R7			HC5 HX, HBS	HU	65 TU	VT, HH			
HY								HV, HDS, HXD	HW		VH, B40			
Stainless	Double Sided	EA, SF	MQ, GU	MF	FP	MF1	NF4	F5	FS	SU	HA			
		ET	HU	MR MN-MR	RP	MR6, MF5 MM-RR6	NR4	M5		GU	SM	VM	TNM	
Cast Iron	Double Sided	MT	MG-	KF, KM	FN				MA	UZ	CM			
		MG-	C		RP		NM5		MG-		B25			
		RT	ZS, GC	KR	UN				GH	GZ	CH	GR		
For Steel	POSITIVE INSERTS	(WS)		WF	FW	W-F1			SW	LUW		WF		
		WT		WM	MW	W-F2			MW				WG	
		FA	CF GK, GP, DP	PF, UF	UF, 11, GM	FF1	PF4 PF5			FV	LU FP	O1, PF	HFP	38, PF
		FG	HQ	UM	FP LF	F1	PS4 PS5	PM3\PM4		SQ, SV	FK SU SC, SK	PS	HMP, CO5	SM 16, GT-
		(PC)		PM	MP									
		MT	MT-	PR, UR	MF	F2	PM5 MT-	PM5		MQ, MV MT- G	SF, MU	PM	C25	14, 17 19, MT-
		PMR-	GP, HQ G, PMR-	PMR-	PMR-			PMR-		PMR-	UJ			
For Aluminum	FL	AH	AL	HP	AL	PM2	IL	AZ	AG	AL	AK, TA	AF, AS		
Description	Ingersoll	Kyocera	Sandvik	Kennametal	Seco	Walter	Valenite	Mitsubishi	Sumitomo	Tungaloy	Korloy	Iscar		

GENERAL TECHNICAL INFORMATION

TOTURN™ TOOL HOLDER CLAMPING SYSTEM

T-TYPE HOLDER **T**

1. Insert
2. Shim Screw
3. Shim
4. Clamp Screw
5. Clamp
6. Spring

TOP CLAMP TYPE **C**

1. Insert
2. Shim
3. Shim Screw
4. Clamp
5. Clamp Screw
6. Pin and Spring
7. Clamp Spring

MULTI LOCK TYPE **M**

1. Insert
2. Shim
3. Lock Pin
4. Clamp
5. Clamp Screw

LEVER LOCK TYPE **P**

1. Insert
2. Shim
3. Lever
4. Shim Pin
5. Screw

SCREW CLAMP TYPE **S**

1. Insert
2. Shim
3. Screw
4. Shim Screw

GENERAL TECHNICAL INFORMATION

TOTURN™ TOOL HOLDER CLAMPING SYSTEM

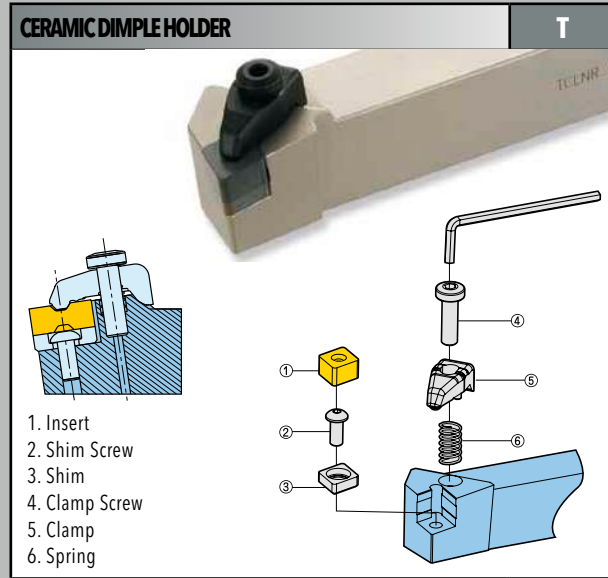
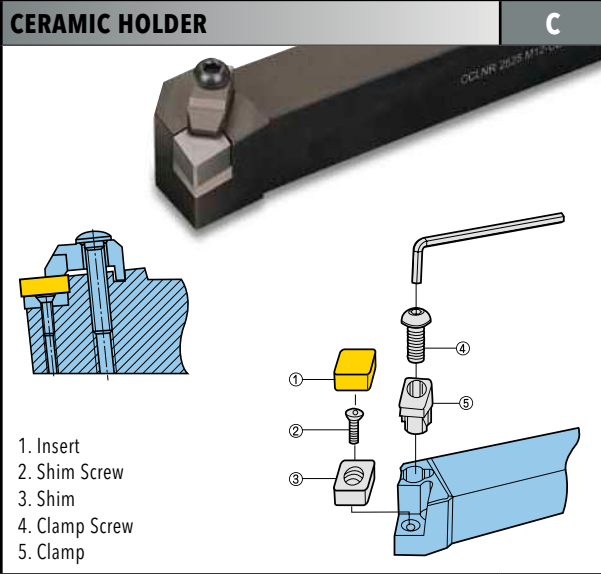

Torque Specs for T-Type Holders			
CLAMP #	Newton Meters	Foot - Pounds	Inch - Pounds
DLM 3	2	1.5	18
DLM 4	4.2	3.1	37
DLM 5	6.4	4.7	57
DLM 6	6.4	4.7	57
DLM 3 - V16	5	3.7	44
Hard Turning Holders			
BCL 6	7.85	5.8	69
CCL 4	10.79	8.0	95

■ **GENERAL TECHNICAL INFORMATION**

NOTES



Ingersoll



CUTTING TOOLS

CUTTING TOOLS

THREADING.

Cutting Tools



Member IMC Group
Ingersoll
Cutting Tools

GENERAL TECHNICAL INFORMATION

TOTURN™ THREAD TURNING INSERTS DESIGNATION SYSTEM

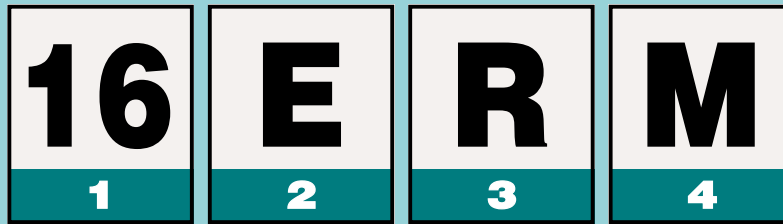

1 INSERT SIZE

L (mm)	IC
06	5/32"
08	3/16"
11	1/4"
16	3/8"
22	1/2"
27	5/8"

A diagram of a yellow thread turning insert with a central hole. Dimension lines indicate 'L' for the length and 'IC' for the inner diameter.

2 APPLICATION

E - External
I - Internal
UE - U, external
UI - U, internal
UEI - U, external and internal

Two diagrams of yellow thread turning inserts. The first is labeled 'U-type' and has a U-shaped profile. The second is labeled 'Regular Type' and has a standard trapezoidal profile.

3 HAND OF TOOL

R - Right hand
L - Left hand
RL - Right hand, Left hand

4 TYPE

M - Pressed chipbreaker
" - No indication, regular type

TOTURN™ THREAD TURNING INSERTS DESIGNATION SYSTEM

1.50

5

ISO

6

2M

7

TT9030

8

5 PITCH

Full Profile

(Value by number 0,35 - 9,0 mm
72 - 2 TPI)

Partial Profile

(Range by letter)

	mm	TPI
A	0,5 - 1,5	48 - 16
AG	0,5 - 3,0	48 - 8
G	1,75 - 3,0	14 - 8
N	3,5 - 5,0	7 - 5
U	5,5 - 9,0	4,5 - 2,75
Q	5,5 - 6,0	4,5 - 4

6 THREAD STANDARD

60	- Partial profile
55	- Partial profile
ISO	- ISO metric
UN	- American
W	- Whitworth
BSPT	- British
RND	- Round
TR	- Trapeze
ACME	- ACME
STACME	- Stub
ABUT	- American buttress
UNJ	- UNJ
NPT	- NPT
API RD	- API Round
BUT	- API buttress casing
VAM	- VAM
API	- API

7 NO. OF TEETH (OPTIONAL)

2M - 2 teeth
3M - 3 teeth

8 GRADE













Coated













TT6010
TT7010
TT8010
TT9030

Uncoated

CT3000(Cermet)
P30
UF10













THREADING.

	Designation	Description	Page
	T₀THREAD Partial Profile 55°	External, regular and M-type (pressed)	1184
	T₀THREAD Partial Profile 55°	Internal, regular, M-type (pressed) and U-type	1185
	T₀THREAD Partial Profile 60°	External, regular and M-type (pressed)	1186
	T₀THREAD Partial Profile 60°	Internal, regular, M-type (pressed) and U-type	1187
	T₀THREAD ISO Metric	External, left hand, full profile, DIN 13-12-1986 CLASS 6G	1188
	T₀THREAD ISO Metric	External right hand, full profile, DIN 13-12-1986 CLASS 6G	1189
	T₀THREAD ISO Metric (M-type)	External, right hand, pressed, full profile, DIN 13-12-1986 CLASS 6G	1190
	T₀THREAD ISO Metric (U-type)	External, full profile, DIN 13-12-1986 CLASS 6G	1191
	T₀THREAD ISO Metric	Internal, left hand, full profile, DIN 13-12-1986 CLASS 6G	1192
	T₀THREAD ISO Metric	Internal, right hand, full profile, DIN 13-12-1986 CLASS 6G	1194
	T₀THREAD ISO Internal (M-type)	Internal, right hand, pressed, full profile, DIN 13-12-1986 CLASS 6G	1196
	T₀THREAD ISO Metric (U-type)	Internal, full profile, DIN 13-12-1986 CLASS 6G	1197

	Designation	Description	Page
	TOTHREAD American UN	External, left hand, full profile (UN, UNC, UNF, UNEF) ANSI B1, 3M-1986 CLASS 2A	1198
	TOTHREAD American UN	External, right hand, full profile (UN, UNC, UNF, UNEF) ANSI B1, 3M-1986 CLASS 2A	1199
	TOTHREAD American UN (M-type)	External, right hand, pressed, full profile (UN, UNC, UNF, UNEF) ANSI B1, 3M-1986 CLASS 2A	1200
	TOTHREAD American UN (U-type)	External, full profile (UN, UNC, UNF, UNEF) ANSI B1, 3M-1986 CLASS 2A	1201
	TOTHREAD American UN	Internal, left hand, full profile (UN, UNC, UNF, UNEF) ANSI B1, 3M-1986 CLASS 2A	1202
	TOTHREAD American UN (UN, UNC, UNF, UNEF)	Internal, right hand, full profile (UN, UNC, UNF, UNEF) ANSI B1, 3M - 1986 CLASS 2A	1204
	TOTHREAD American UN	Internal, right hand, pressed, full profile (UN, UNC, UNF, UNEF) ANSI B1, 3M-1986 CLASS 2A	1206
	TOTHREAD American UN	Internal, full profile (UN, UNC, UNF, UNEF) ANSI B1, 3M-1986 CLASS 2A	1207
	TOTHREAD Whitworth	External, left hand, full profile (BSW, BSF, BSP) BS.84-1956 DIN 259 MEDIUM CLASS	1208
	TOTHREAD Whitworth	External, right hand, full profile (BSW, BSF, BSP) BS.84-1956 DIN 259 MEDIUM CLASS	1209
	TOTHREAD Whitworth (M-type)	External, right hand, pressed, full profile (BSW, BSF, BSP) BS.84-1956 DIN 259 MEDIUM CLASS	1210
	TOTHREAD Whitworth	Internal, left hand, full profile (BSW, BSF, BSP) BS.84-1956 DIN 259 MEDIUM CLASS	1212

THREADING.

	Designation	Description	Page
	T₀THREAD Whitworth	Internal, right hand, full profile (BSW, BSF, BSP) BS.84-1956 DIN 259 medium class	1214
	T₀THREAD Whitworth (M-type)	Internal, right hand, pressed, full profile (BSW, BSF, BSP) BS.84-1956 DIN 259 medium class	1216
	T₀THREAD Whitworth (U-type)	Internal, full profile (BSN, BSF, BSP) BS.84-1956 DIN 259 medium class	1216
	T₀THREAD Whitworth (U-type)	Internal and external, full profile (BSN, BSF, BSP) BS.84-1956 DIN 259 medium class	1217
	T₀THREAD NPT (National Pipe Thread)	External, full profile (ANSI/ASME B1.20.1-1983), regular and M-type	1218
	T₀THREAD NPT (National Pipe Thread)	Internal, full profile (ANSI/ASME B1.20.1-1983), regular and M-type	1219
	T₀THREAD NPT (National Pipe Thread - Dry Seal)	External, full profile (ANSI/ASME B1.20.3-1976)	1220
	T₀THREAD NPT (National Pipe Thread - Dry Seal)	Internal, full profile (ANSI/ASME B1.20.3-1976)	1221
	T₀THREAD BSPT (British Standard Pipe Thread)	External, full profile (B.S.21-1957)	1222
	T₀THREAD BSPT (British Standard Pipe Thread)	Internal, full profile (B.S.21-1957)	1223
	T₀THREAD Stub Acme	External (ASME/ANSI B1.5-1988 CLASS 2G)	1224
	T₀THREAD Stub Acme	Internal (ASME/ANSI B1.5-1988 CLASS 2G)	1225

	Designation	Description	Page
	T₀THREAD Acme	External (ASME/ANSI B1.5-1988 CLASS 3G)	1226
	T₀THREAD Acme	Internal (ASME/ANSI B1.5-1988 CLASS 3G)	1227
	T₀THREAD UNJ	External, left hand, full profile (S-8879C 9-1992 CLASS 3A)	1228
	T₀THREAD UNJ	External, right hand, full profile (S-8879C 9-1992 CLASS 3A)	1229
	T₀THREAD UNJ	Internal, right hand, full profile (S-8879C 9-1992 CLASS 3A)	1230
	T₀THREAD Trapeze DIN 103	External & internal (DIN 103 04/1977 CLASS 7H (EXTERNAL) CLASS 7E (INTERNAL))	1231
	T₀THREAD Trapeze DIN 103 (U-type)	External & internal (DIN 103 04/1977 CLASS 7H (EXTERNAL) CLASS 7E (INTERNAL))	1232
	T₀THREAD Sage DIN 513	External & internal (DIN 513 04-1985)	1233
	T₀THREAD Sage DIN 513 (U-type)	External & internal (DIN 513 04-1985)	1234
	T₀THREAD American Buttress	External & internal (ANSI B1.9-1973 CLASS 2)	1235
	T₀THREAD American Buttress (U-type)	External & internal (ANSI B1.9-1973 CLASS 2)	1236
	T₀THREAD API - Oil Threads	External & internal, API round type (API spec 5B8-1996)	1237

TOTHREAD PARTIAL PROFILE 55°

EXTERNAL - REGULAR AND M-TYPE (PRESSED)

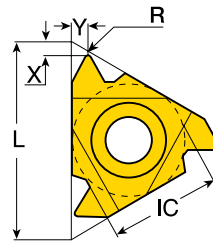

*Right hand shown

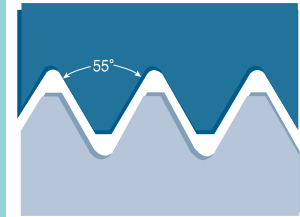

Application: General Industry

Designation	Thread Type	Hand	Insert Type	IC (inch)	Pitch (mm)	TPI	L (inch)	R (inch)	X (inch)	Y (inch)	Grade	T17010	T19030		
11ELA55	External	Left	Regular	0.250	.05-1.5	48-16	0.433	0.002	0.031	0.035					
16ELA55	External	Left	Regular	0.375	.05-1.5	48-16	0.630	0.002	0.031	0.035					
16ELAG55	External	Left	Regular	0.375	0.5-3.0	48-8	0.630	0.002	0.047	0.067		●	●		
16ELG55	External	Left	Regular	0.375	1.75-3.0	14-8	0.630	0.008	0.047	0.067					
22ELN55	External	Left	Regular	0.500	3.5-5.0	7-5	0.866	0.002	0.067	0.098					
27ELQ55	External	Left	Regular	0.625	5.5-6.0	4.5-4	1.063	0.017	0.079	0.114					
11ERA55	External	Right	Regular	0.250	.05-1.5	48-16	0.433	0.002	0.031	0.035					
11ERA55	External	Right	Regular	0.250	.05-1.5	48-16	0.433	0.002	0.031	0.035					
16ERA55	External	Right	Regular	0.375	.05-1.5	48-16	0.630	0.002	0.031	0.035			●		
16ERAG55	External	Right	Regular	0.375	0.5-3.0	48-8	0.630	0.002	0.047	0.067			●		
16ERMAG55	External	Right	M-Type	0.375	0.5-3.0	48-8	0.630	0.002	0.047	0.067			●		
16ERG55	External	Right	Regular	0.375	1.75-3.0	14-8	0.630	0.008	0.047	0.067					
16ERMG55	External	Right	M-Type	0.375	1.75-3.0	14-8	0.630	0.009	0.047	0.067			●		
22ERN55	External	Right	Regular	0.500	3.5-5.0	7-5	0.866	0.002	0.067	0.098		●			
27ERQ55	External	Right	Regular	0.625	5.5-6.0	4.5-4	1.063	0.017	0.079	0.114					

● = P ● = M ● = K ● = N ● = S ○ = H

INTERNAL - REGULAR, M-TYPE (PRESSED) AND U-TYPE

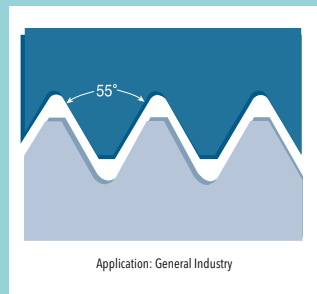
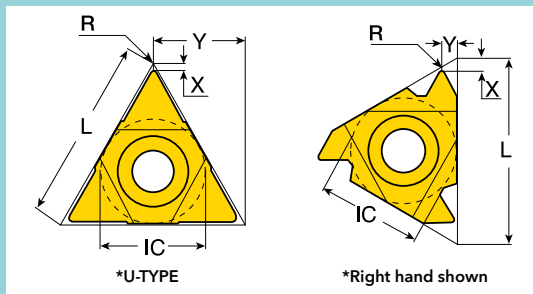
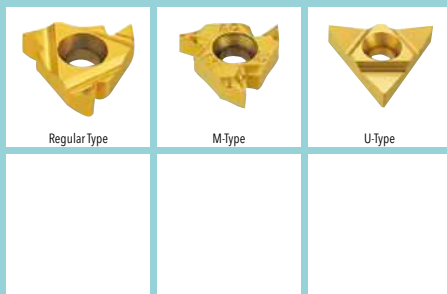

Designation	Thread Type	Hand	Insert Type	IC (inch)	Pitch (mm)	TPI	L (inch)	R (inch)	X (inch)	Y (inch)	Grade		
											TT7010	TT8010	TT9030
08ILA55	Internal	Left	Regular	0.188	.05-1.5	48-16	0.315	0.002	0.024	0.028			
11ILA55	Internal	Left	Regular	0.250	.05-1.5	48-16	0.433	0.002	0.031	0.035			
16ILA55	Internal	Left	Regular	0.375	.05-1.5	48-16	0.630	0.002	0.031	0.035			
06ILA55	Internal	Left	Regular	0.156	0.5-1.25	48-20	0.236	0.002	0.024	0.024			
16ILAG55	Internal	Left	Regular	0.375	0.5-3.0	48-8	0.630	0.002	0.047	0.067			●
16ILG55	Internal	Left	Regular	0.375	1.75-3.0	14-8	0.630	0.008	0.047	0.067			●
22ILN55	Internal	Left	Regular	0.500	3.5-5.0	7-5	0.866	0.017	0.067	0.098			
27ILQ55	Internal	Left	Regular	0.625	5.5-6.0	4.5-4	1.063	0.024	0.079	0.114			
08UIRLU55	Internal	Neutral	U-Type	0.188	1.75-2.0	14-11	0.315	0.004	0.035	0.157		●	
22UEIRLU55	Internal	Neutral	U-Type	0.500	5.5-8.0	4.5-3.25	0.866	0.024	0.035	0.433			
27UEIRLU55	Internal	Neutral	U-Type	0.625	6.5-9.0	4-2.75	1.063	0.032	0.047	0.539			
06IRA55	Internal	Right	Regular	0.156	0.5-1.25	48-20	0.236	0.002	0.024	0.024		●	
08IRA55	Internal	Right	Regular	0.188	.05-1.5	48-16	0.315	0.002	0.024	0.028		●	
11IRA55	Internal	Right	Regular	0.250	.05-1.5	48-16	0.433	0.002	0.031	0.035			●
16IRA55	Internal	Right	Regular	0.375	.05-1.5	48-16	0.630	0.002	0.031	0.035			
16IRAG55	Internal	Right	Regular	0.375	0.5-3.0	48-8	0.630	0.002	0.047	0.067			●
16IRMAG55	Internal	Right	M-Type	0.375	0.5-3.0	48-8	0.630	0.003	0.047	0.067			●
16IRG55	Internal	Right	Regular	0.375	1.75-3.0	14-8	0.630	0.008	0.047	0.067			
16IRMG55	Internal	Right	M-Type	0.375	1.75-3.0	14-8	0.630	0.009	0.047	0.067			●
22IRN55	Internal	Right	Regular	0.500	3.5-5.0	7-5	0.866	0.017	0.067	0.098	●		
27IRQ55	Internal	Right	Regular	0.625	5.5-6.0	4.5-4	1.063	0.024	0.079	0.114			

● = P ● = M ● = K ● = N ● = S ○ = H

TOTHREAD PARTIAL PROFILE 60°

EXTERNAL - REGULAR AND M-TYPE (PRESSED)

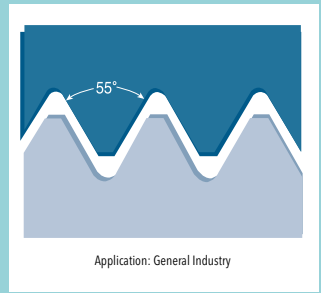
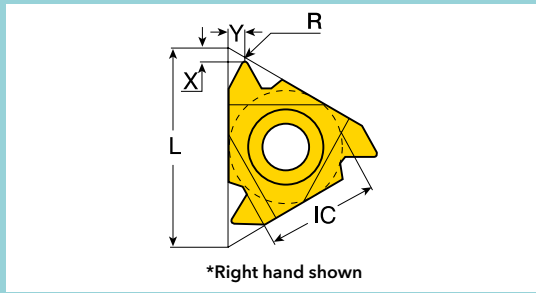
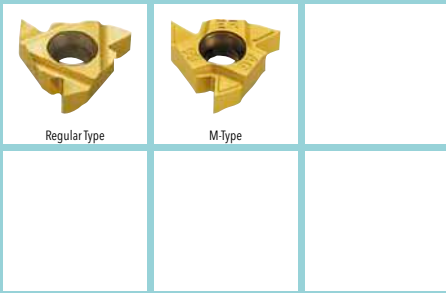

Designation	Thread Type	Hand	Insert Type	IC (inch)	Pitch (mm)	TPI	L (inch)	R (inch)	X (inch)	Y (inch)	Grade	P30	TT7010	TT8010	TT9030
11ELA60	External	Left	Regular	0.250	.05-1.5	48-16	0.433	0.002	0.031	0.035					
16ELA60	External	Left	Regular	0.375	.05-1.5	48-16	0.630	0.002	0.031	0.035					
16ELAG60	External	Left	Regular	0.375	0.5-3.0	48-8	0.630	0.002	0.047	0.067					
16ELG60	External	Left	Regular	0.375	1.75-3.0	14-8	0.630	0.007	0.047	0.067					
22ELN60	External	Left	Regular	0.500	3.5-5.0	7-5	0.866	0.013	0.067	0.098					
22ELQ60	External	Left	Regular	0.625	5.5-6.0	4.5-4	1.063	0.025	0.083	0.122					
11ERA60	External	Right	Regular	0.250	.05-1.5	48-16	0.433	0.002	0.031	0.035					
16ERA60	External	Right	Regular	0.375	.05-1.5	48-16	0.630	0.002	0.031	0.035					
16ERMA60	External	Right	M-Type	0.375	.05-1.5	48-16	0.630	0.002	0.031	0.035					
16ERAG60	External	Right	Regular	0.375	0.5-3.0	48-16	0.630	0.002	0.047	0.067					
16ERMAG60	External	Right	M-Type	0.375	0.5-3.0	48-8	0.630	0.002	0.047	0.067					
16ERG60	External	Right	Regular	0.375	1.75-3.0	14-8	0.630	0.007	0.047	0.067					
16ERMG60	External	Right	M-Type	0.375	1.75-3.0	14-8	0.630	0.007	0.047	0.067					
22ERMN60	External	Right	M-Type	0.500	3.5-5.0	7-5	0.866	0.013	0.067	0.098					
22ERN60	External	Right	Regular	0.500	3.5-5.0	7-5	0.866	0.013	0.067	0.098					
27ERQ60	External	Right	Regular	0.625	5.5-6.0	4.5-4	1.063	0.025	0.083	0.122					

● = P ● = M ● = K ● = N ● = S ○ = H

INTERNAL - REGULAR, M-TYPE (PRESSED) AND U-TYPE

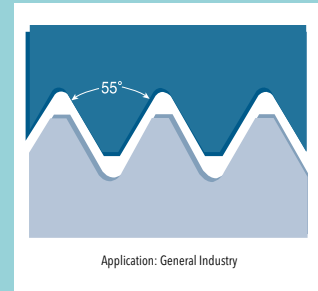
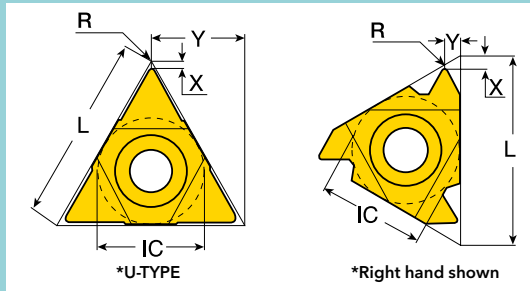
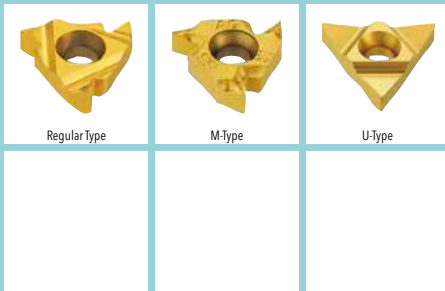

Designation	Thread Type	Hand	Insert Type	IC (inch)	Pitch (mm)	TPI	L (inch)	R (inch)	X (inch)	Y (inch)	Grade	P30	T77010	T78010	T79030	
08ILA60	Internal	Left	Regular	0.188	.05-1.5	48-16	0.315	0.002	0.024	0.028						●
11ILA60	Internal	Left	Regular	0.250	.05-1.5	48-16	0.433	0.002	0.031	0.035						●
16ILA60	Internal	Left	Regular	0.375	.05-1.5	48-16	0.630	0.002	0.031	0.035						●
06ILA60	Internal	Left	Regular	0.156	0.5-1.25	48-20	0.236	0.002	0.020	0.024						
16ILAG60	Internal	Left	Regular	0.375	0.5-3.0	48-8	0.630	0.002	0.047	0.067			●			●
16ILG60	Internal	Left	Regular	0.375	1.75-3.0	14-8	0.630	0.005	0.047	0.067						●
27ILQ60	Internal	Left	Regular	0.625	5.5-6.0	4.5-4	1.063	0.012	0.071	0.106		●				
08UIRLU60	Internal	Neutral	U-Type	0.188	1.75-2.0	14-11	0.315	0.004	0.031	0.157						●
22UEIRLU60	Internal	Neutral	U-Type	0.500	5.5-8.0	4.5-3.25	0.866	0.011	0.024	0.433						●
27UEIRLU60	Internal	Neutral	U-Type	0.625	6.5-9.0	4-2.75	1.063	0.011	0.039	0.539			●			
08IRA60	Internal	Right	Regular	0.188	.05-1.5	48-16	0.315	0.002	0.024	0.028						●
08IRMA60	Internal	Right	M-Type	0.188	.05-1.5	48-16	0.315	0.002	0.024	0.028						●
11IRA60	Internal	Right	Regular	0.250	.05-1.5	48-16	0.433	0.002	0.031	0.035						●
11IRMA60	Internal	Right	M-Type	0.250	.05-1.5	48-16	0.433	0.002	0.031	0.035			●			●
16IRA60	Internal	Right	Regular	0.375	.05-1.5	48-16	0.630	0.002	0.031	0.035						●
16IRMA60	Internal	Right	M-Type	0.375	.05-1.5	48-16	0.630	0.002	0.031	0.035			●			●
06IRA60	Internal	Right	Regular	0.156	0.5-1.25	48-20	0.236	0.002	0.020	0.024						●
06IRMA60	Internal	Right	M-Type	0.156	0.5-1.25	48-20	0.236	0.002	0.020	0.024						●
16IRAG60	Internal	Right	Regular	0.375	0.5-3.0	48-8	0.630	0.002	0.047	0.067			●			●
16IRMAG60	Internal	Right	M-Type	0.375	0.5-3.0	48-8	0.630	0.002	0.047	0.067			●			●
16IRG60	Internal	Right	Regular	0.375	1.75-3.0	14-8	0.630	0.005	0.047	0.067		●	●			●
16IRMG60	Internal	Right	M-Type	0.375	1.75-3.0	14-8	0.630	0.005	0.047	0.067			●			●
22ILN60	Internal	Right	Regular	0.500	3.5-5.0	7-5	0.866	0.009	0.067	0.098		●				
22IRMN60	Internal	Right	M-Type	0.500	3.5-5.0	7-5	0.866	0.007	0.067	0.098			●			●
22IRN60	Internal	Right	Regular	0.500	3.5-5.0	7-5	0.866	0.009	0.067	0.098						●
27IRQ60	Internal	Right	Regular	0.625	5.5-6.0	4.5-4	1.063	0.012	0.071	0.106			●			

● = P ● = M ● = K ● = N ● = S ○ = H

EXTERNAL - LEFT HAND, FULL PROFILE, DIN 13-12-1986 CLASS 6G

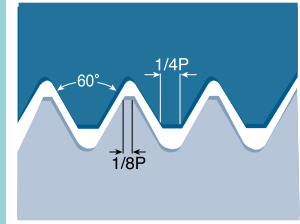
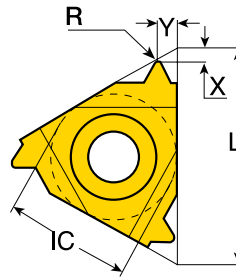

Application: General Industry

Designation	Thread Type	Hand	Insert Type	IC (inch)	Pitch (mm)	TPI	L (inch)	R (inch)	X (inch)	Y (inch)	Grade	T77010	T79030		
11EL0.35ISO	External	Left	Regular	0.250	0.35	NA	0.433	0.002	0.031	0.016					
11EL0.40ISO	External	Left	Regular	0.250	0.40	NA	0.433	0.002	0.028	0.016					
11EL0.45ISO	External	Left	Regular	0.250	0.45	NA	0.433	0.002	0.028	0.016					
11EL0.50ISO	External	Left	Regular	0.250	0.50	NA	0.433	0.002	0.024	0.024					
11EL0.60ISO	External	Left	Regular	0.250	0.60	NA	0.433	0.003	0.024	0.024					
11EL0.70ISO	External	Left	Regular	0.250	0.70	NA	0.433	0.003	0.024	0.024					
11EL0.75ISO	External	Left	Regular	0.250	0.75	NA	0.433	0.003	0.024	0.024					
11EL0.80ISO	External	Left	Regular	0.250	0.80	NA	0.433	0.004	0.024	0.024					
11EL1.00ISO	External	Left	Regular	0.250	1.00	NA	0.433	0.005	0.028	0.028					
11EL1.25ISO	External	Left	Regular	0.250	1.25	NA	0.433	0.006	0.031	0.035					
11EL1.50ISO	External	Left	Regular	0.250	1.50	NA	0.433	0.007	0.031	0.039					
11EL1.75ISO	External	Left	Regular	0.250	1.75	NA	0.433	0.008	0.031	0.043					
16EL0.35ISO	External	Left	Regular	0.375	0.35	NA	0.630	0.002	0.031	0.016					
16EL0.40ISO	External	Left	Regular	0.375	0.40	NA	0.630	0.002	0.028	0.016					
16EL0.45ISO	External	Left	Regular	0.375	0.45	NA	0.630	0.002	0.028	0.016					
16EL0.50ISO	External	Left	Regular	0.375	0.50	NA	0.630	0.002	0.024	0.024					
16EL0.60ISO	External	Left	Regular	0.375	0.60	NA	0.630	0.003	0.024	0.024					
16EL0.70ISO	External	Left	Regular	0.375	0.70	NA	0.630	0.003	0.024	0.024					
16EL0.75ISO	External	Left	Regular	0.375	0.75	NA	0.630	0.003	0.024	0.024					
16EL1.00ISO	External	Left	Regular	0.375	1.00	NA	0.630	0.004	0.028	0.028					
16EL1.25ISO	External	Left	Regular	0.375	1.25	NA	0.630	0.004	0.031	0.035					
16EL1.50ISO	External	Left	Regular	0.375	1.50	NA	0.630	0.006	0.031	0.039					
16EL1.75ISO	External	Left	Regular	0.375	1.75	NA	0.630	0.007	0.035	0.047					
16EL2.00ISO	External	Left	Regular	0.375	2.00	NA	0.630	0.008	0.039	0.051					
16EL2.50ISO	External	Left	Regular	0.375	2.50	NA	0.630	0.012	0.043	0.059					
16EL3.00ISO	External	Left	Regular	0.375	3.00	NA	0.630	0.015	0.047	0.063					
22EL3.50ISO	External	Left	Regular	0.500	3.50	NA	0.866	0.017	0.063	0.091					
22EL4.00ISO	External	Left	Regular	0.500	4.00	NA	0.866	0.020	0.063	0.091					
22EL4.50ISO	External	Left	Regular	0.500	4.50	NA	0.866	0.023	0.067	0.094					
22EL5.00ISO	External	Left	Regular	0.500	5.00	NA	0.866	0.025	0.067	0.098					
27EL5.50ISO	External	Left	Regular	0.625	5.50	NA	1.063	0.028	0.075	0.106					
27EL6.00ISO	External	Left	Regular	0.625	6.00	NA	1.063	0.031	0.079	0.114					

● = P ● = M ● = K ● = N ● = S ○ = H

EXTERNAL - RIGHT HAND, FULL PROFILE, DIN 13-12-1986 CLASS 6G

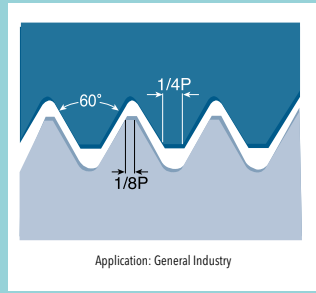
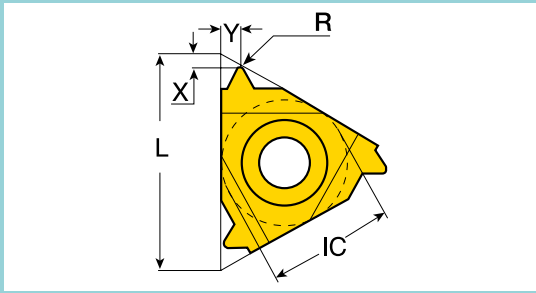
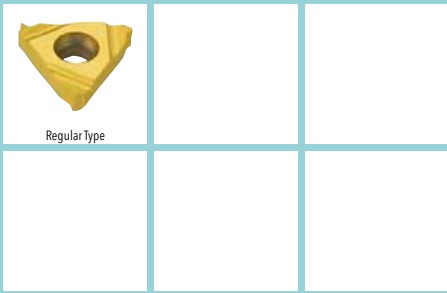

Designation	Thread Type	Hand	Insert Type	IC (inch)	Pitch (mm)	TPI	L (inch)	R (inch)	X (inch)	Y (inch)	Grade	TT7010	TT9030		
11ER0.35ISO	External	Right	Regular	0.250	0.35	NA	0.433	0.002	0.031	0.016					
11ER0.40ISO	External	Right	Regular	0.250	0.40	NA	0.433	0.002	0.028	0.016					
11ER0.45ISO	External	Right	Regular	0.250	0.45	NA	0.433	0.002	0.028	0.016					
11ER0.50ISO	External	Right	Regular	0.250	0.50	NA	0.433	0.002	0.024	0.024	●				
11ER0.60ISO	External	Right	Regular	0.250	0.60	NA	0.433	0.003	0.024	0.024					
11ER0.70ISO	External	Right	Regular	0.250	0.70	NA	0.433	0.003	0.024	0.024			●		
11ER0.75ISO	External	Right	Regular	0.250	0.75	NA	0.433	0.003	0.024	0.024					
11ER0.80ISO	External	Right	Regular	0.250	0.80	NA	0.433	0.004	0.024	0.024			●		
11ER1.00ISO	External	Right	Regular	0.250	1.00	NA	0.433	0.005	0.028	0.028			●		
11ER1.25ISO	External	Right	Regular	0.250	1.25	NA	0.433	0.006	0.031	0.035	●				
11ER1.50ISO	External	Right	Regular	0.250	1.50	NA	0.433	0.007	0.031	0.039	●				
11ER1.75ISO	External	Right	Regular	0.250	1.75	NA	0.433	0.008	0.031	0.043					
16ER0.35ISO	External	Right	Regular	0.375	0.35	NA	0.630	0.002	0.031	0.016				●	
16ER0.40ISO	External	Right	Regular	0.375	0.40	NA	0.630	0.002	0.028	0.016				●	
16ER0.45ISO	External	Right	Regular	0.375	0.45	NA	0.630	0.002	0.028	0.016					
16ER0.50ISO	External	Right	Regular	0.375	0.50	NA	0.630	0.002	0.024	0.024				●	
16ER0.60ISO	External	Right	Regular	0.375	0.60	NA	0.630	0.003	0.024	0.024					
16ER0.70ISO	External	Right	Regular	0.375	0.70	NA	0.630	0.003	0.024	0.024				●	
16ER0.75ISO	External	Right	Regular	0.375	0.75	NA	0.630	0.003	0.024	0.024				●	
16ER0.80ISO	External	Right	Regular	0.375	0.80	NA	0.630	0.004	0.024	0.024				●	
16ER1.00ISO	External	Right	Regular	0.375	1.00	NA	0.630	0.004	0.028	0.028				●	
16ER1.25ISO	External	Right	Regular	0.375	1.25	NA	0.630	0.004	0.031	0.035				●	
16ER1.50ISO	External	Right	Regular	0.375	1.50	NA	0.630	0.006	0.031	0.039				●	
16ER1.75ISO	External	Right	Regular	0.375	1.75	NA	0.630	0.007	0.035	0.047				●	
16ER2.00ISO	External	Right	Regular	0.375	2.00	NA	0.630	0.008	0.039	0.051				●	
16ER2.50ISO	External	Right	Regular	0.375	2.50	NA	0.630	0.012	0.043	0.059				●	
16ER3.00ISO	External	Right	Regular	0.375	3.00	NA	0.630	0.015	0.047	0.063				●	
22ER3.50ISO	External	Right	Regular	0.500	3.50	NA	0.866	0.017	0.063	0.091				●	
22ER4.00ISO	External	Right	Regular	0.500	4.00	NA	0.866	0.020	0.063	0.091				●	
22ER4.50ISO	External	Right	Regular	0.500	4.50	NA	0.866	0.023	0.067	0.094				●	
22ER5.00ISO	External	Right	Regular	0.500	5.00	NA	0.866	0.025	0.067	0.098	●				
27ER5.50ISO	External	Right	Regular	0.625	5.50	NA	1.063	0.028	0.075	0.106				●	
27ER6.00ISO	External	Right	Regular	0.625	6.00	NA	1.063	0.031	0.079	0.114	●				

● = P ● = M ● = K ● = N ● = S ○ = H

TOTHREAD ISO METRIC (M-TYPE)

EXTERNAL - RIGHT HAND, PRESSED, FULL PROFILE, DIN 13-12-1986 CLASS 6G



M-Type

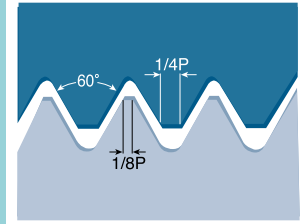
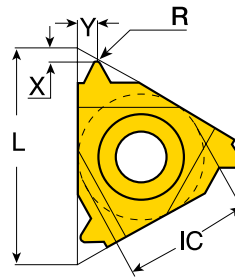

Application: General Industry

Designation	Thread Type	Hand	Insert Type	IC (inch)	Pitch (mm)	TPI	L (inch)	R (inch)	X (inch)	Y (inch)	Grade	T77010	T9030		
16ERM1.00ISO	External	Right	M-Type	0.375	1.00	NA	0.630	0.005	0.028	0.028					
16ERM1.25ISO	External	Right	M-Type	0.375	1.25	NA	0.630	0.006	0.031	0.035					
16ERM1.50ISO	External	Right	M-Type	0.375	1.50	NA	0.630	0.007	0.031	0.039					
16ERM1.75ISO	External	Right	M-Type	0.375	1.75	NA	0.630	0.008	0.035	0.047					
16ERM2.00ISO	External	Right	M-Type	0.375	2.00	NA	0.630	0.010	0.039	0.051					
16ERM2.50ISO	External	Right	M-Type	0.375	2.50	NA	0.630	0.012	0.043	0.059					
16ERM3.00ISO	External	Right	M-Type	0.375	3.00	NA	0.630	0.015	0.047	0.063					

● = P ● = M ● = K ● = N ● = S ○ = H

TOTHREAD ISO METRIC (U-TYPE)

EXTERNAL - FULL PROFILE, DIN 13-12-1986 CLASS 6G

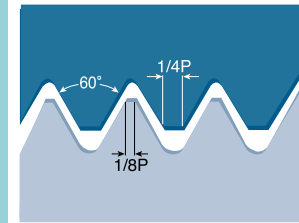
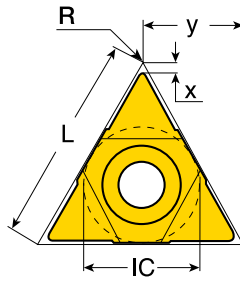
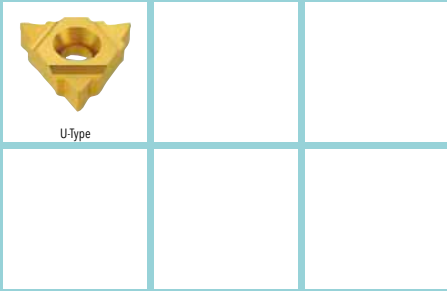

Application: General Industry

Designation	Thread Type	Hand	Insert Type	IC (inch)	Pitch (mm)	TPI	L (inch)	R (inch)	X (inch)	Y (inch)	Grade	TT9030			
22UERL5.50ISO	External	Neutral	U-Type	0.500	5.50	NA	0.866	0.028	0.091	0.433					
22UERL5.50ISO	External	Neutral	U-Type	0.500	5.50	NA	0.866	0.028	0.091	0.433					
22UERL6.00ISO	External	Neutral	U-Type	0.500	6.00	NA	0.866	0.031	0.102	0.433					
27UERL8.00ISO	External	Neutral	U-Type	0.625	8.00	NA	1.063	0.043	0.094	0.539					

● = P ● = M ● = K ● = N ● = S ○ = H

TOTHREAD ISO METRIC

INTERNAL - LEFT HAND, FULL PROFILE, DIN 13-12-1986 CLASS 6G

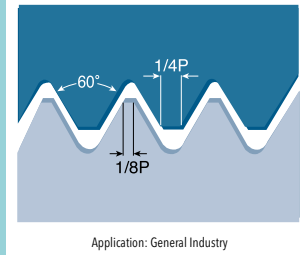
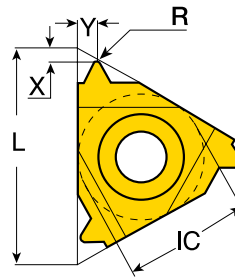

Designation	Thread Type	Hand	Insert Type	IC (inch)	Pitch (mm)	TPI	L (inch)	R (inch)	X (inch)	Y (inch)	Grade	T77010	T18010	T9030
06IL0.50ISO	Internal	Left	Regular	0.156	0.50	NA	0.236	0.001	0.020	0.020				
06IL0.75ISO	Internal	Left	Regular	0.156	0.75	NA	0.236	0.002	0.020	0.020				
06IL1.00ISO	Internal	Left	Regular	0.156	1.00	NA	0.236	0.002	0.020	0.024				
06IL1.25ISO	Internal	Left	Regular	0.156	1.25	NA	0.236	0.003	0.024	0.024				
08IL0.50ISO	Internal	Left	Regular	0.188	0.50	NA	0.315	0.002	0.024	0.020				
08IL0.75ISO	Internal	Left	Regular	0.188	0.75	NA	0.315	0.002	0.024	0.020				
08IL1.00ISO	Internal	Left	Regular	0.188	1.00	NA	0.315	0.002	0.024	0.024				
08IL1.25ISO	Internal	Left	Regular	0.188	1.25	NA	0.315	0.003	0.024	0.028				
08IL1.50ISO	Internal	Left	Regular	0.188	1.50	NA	0.315	0.003	0.024	0.028			●	
08IL1.75ISO	Internal	Left	Regular	0.188	1.75	NA	0.315	0.004	0.024	0.031				
11IL0.35ISO	Internal	Left	Regular	0.250	0.35	NA	0.433	0.001	0.031	0.012				
11IL0.40ISO	Internal	Left	Regular	0.250	0.40	NA	0.433	0.001	0.031	0.016				
11IL0.45ISO	Internal	Left	Regular	0.250	0.45	NA	0.433	0.001	0.031	0.016				
11IL0.50ISO	Internal	Left	Regular	0.250	0.50	NA	0.433	0.001	0.024	0.024				
11IL0.60ISO	Internal	Left	Regular	0.250	0.60	NA	0.433	0.001	0.024	0.024				
11IL0.70ISO	Internal	Left	Regular	0.250	0.70	NA	0.433	0.002	0.024	0.024				
11IL0.75ISO	Internal	Left	Regular	0.250	0.75	NA	0.433	0.002	0.024	0.024				
11IL0.80ISO	Internal	Left	Regular	0.250	0.80	NA	0.433	0.002	0.024	0.024				
11IL1.00ISO	Internal	Left	Regular	0.250	1.00	NA	0.433	0.002	0.024	0.028				●
11IL1.25ISO	Internal	Left	Regular	0.250	1.25	NA	0.433	0.003	0.031	0.035				
11IL1.50ISO	Internal	Left	Regular	0.250	1.50	NA	0.433	0.003	0.031	0.039				●
11IL1.75ISO	Internal	Left	Regular	0.250	1.75	NA	0.433	0.004	0.035	0.043				
11IL2.00ISO	Internal	Left	Regular	0.250	2.00	NA	0.433	0.005	0.031	0.035				
16IL0.35ISO	Internal	Left	Regular	0.375	0.35	NA	0.630	0.001	0.031	0.012				
16IL0.40ISO	Internal	Left	Regular	0.375	0.40	NA	0.630	0.001	0.031	0.016				
16IL0.45ISO	Internal	Left	Regular	0.375	0.45	NA	0.630	0.001	0.031	0.016				
16IL0.50ISO	Internal	Left	Regular	0.375	0.50	NA	0.630	0.001	0.024	0.024				
16IL0.60ISO	Internal	Left	Regular	0.375	0.60	NA	0.630	0.001	0.024	0.024				
16IL0.70ISO	Internal	Left	Regular	0.375	0.70	NA	0.630	0.002	0.024	0.024				
16IL0.75ISO	Internal	Left	Regular	0.375	0.75	NA	0.630	0.002	0.024	0.024				
16IL0.80ISO	Internal	Left	Regular	0.375	0.80	NA	0.630	0.002	0.024	0.024				
16IL1.00ISO	Internal	Left	Regular	0.375	1.00	NA	0.630	0.002	0.024	0.028				●
16IL1.25ISO	Internal	Left	Regular	0.375	1.25	NA	0.630	0.003	0.031	0.035				
16IL1.50ISO	Internal	Left	Regular	0.375	1.50	NA	0.630	0.003	0.031	0.039				●
16IL1.75ISO	Internal	Left	Regular	0.375	1.75	NA	0.630	0.004	0.035	0.047				
16IL2.00ISO	Internal	Left	Regular	0.375	2.00	NA	0.630	0.005	0.039	0.510				●
16IL2.50ISO	Internal	Left	Regular	0.375	2.50	NA	0.630	0.006	0.043	0.059	●			
16IL3.00ISO	Internal	Left	Regular	0.375	3.00	NA	0.630	0.007	0.043	0.059				●
22IL3.50ISO	Internal	Left	Regular	0.500	3.50	NA	0.866	0.009	0.063	0.091				

● = P ● = M ● = K ● = N ● = S ○ = H

INTERNAL - LEFT HAND, FULL PROFILE, DIN 13-12-1986 CLASS 6G



Regular Type

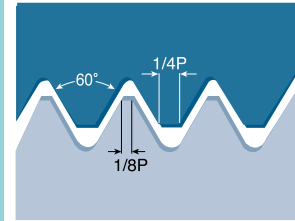
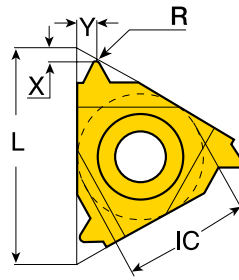

Designation	Thread Type	Hand	Insert Type	IC (inch)	Pitch (mm)	TPI	L (inch)	R (inch)	X (inch)	Y (inch)	Grade		
											TT7010	TT8010	TT9030
22IL4.00ISO	Internal	Left	Regular	0.500	4.00	NA	0.866	0.010	0.063	0.091			
22IL4.50ISO	Internal	Left	Regular	0.500	4.50	NA	0.866	0.011	0.063	0.094			
22IL5.00ISO	Internal	Left	Regular	0.500	5.00	NA	0.866	0.013	0.063	0.091			
27IL5.50ISO	Internal	Left	Regular	0.625	5.50	NA	1.063	0.014	0.063	0.091			
27IL6.00ISO	Internal	Left	Regular	0.625	6.00	NA	1.063	0.015	0.071	0.098			

● = P ● = M ● = K ● = N ● = S ○ = H

TOTHREAD ISO METRIC

INTERNAL - RIGHT HAND, FULL PROFILE, DIN 13-12-1986 CLASS 6G

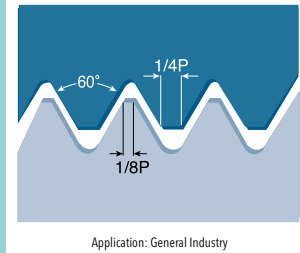
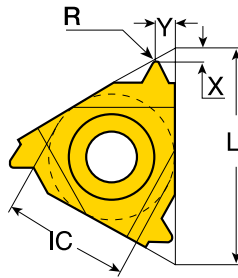
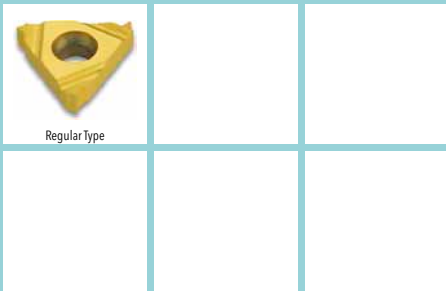

Application: General Industry

Designation	Thread Type	Hand	Insert Type	IC (inch)	Pitch (mm)	TPI	L (inch)	R (inch)	X (inch)	Y (inch)	Grade	T77010	T18010	T99030
06IR0.50ISO	Internal	Right	Regular	0.156	0.50	NA	0.236	0.001	0.020	0.020				
06IR0.75ISO	Internal	Right	Regular	0.156	0.75	NA	0.236	0.002	0.020	0.020				
06IR1.00ISO	Internal	Right	Regular	0.156	1.00	NA	0.236	0.002	0.020	0.024				
06IR1.25ISO	Internal	Right	Regular	0.156	1.25	NA	0.236	0.003	0.024	0.024				
08IR0.50ISO	Internal	Right	Regular	0.188	0.50	NA	0.315	0.002	0.024	0.020				
08IR0.75ISO	Internal	Right	Regular	0.188	0.75	NA	0.315	0.002	0.024	0.020				
08IR1.00ISO	Internal	Right	Regular	0.188	1.00	NA	0.315	0.002	0.024	0.024				
08IR1.25ISO	Internal	Right	Regular	0.188	1.25	NA	0.315	0.003	0.024	0.028				
08IR1.50ISO	Internal	Right	Regular	0.188	1.50	NA	0.315	0.003	0.024	0.028				
08IR1.75ISO	Internal	Right	Regular	0.188	1.75	NA	0.315	0.004	0.024	0.031				
11IR0.35ISO	Internal	Right	Regular	0.250	0.35	NA	0.433	0.001	0.031	0.012				
11IR0.40ISO	Internal	Right	Regular	0.250	0.40	NA	0.433	0.001	0.031	0.016				
11IR0.45ISO	Internal	Right	Regular	0.250	0.45	NA	0.433	0.001	0.031	0.016				
11IR0.50ISO	Internal	Right	Regular	0.250	0.50	NA	0.433	0.001	0.024	0.024				
11IR0.60ISO	Internal	Right	Regular	0.250	0.60	NA	0.433	0.001	0.024	0.024				
11IR0.70ISO	Internal	Right	Regular	0.250	0.70	NA	0.433	0.002	0.024	0.024				
11IR0.75ISO	Internal	Right	Regular	0.250	0.75	NA	0.433	0.002	0.024	0.024				
11IR0.80ISO	Internal	Right	Regular	0.250	0.80	NA	0.433	0.002	0.024	0.024				
11IR1.00ISO	Internal	Right	Regular	0.250	1.00	NA	0.433	0.002	0.024	0.280				
11IR1.25ISO	Internal	Right	Regular	0.250	1.25	NA	0.433	0.003	0.031	0.035				
11IR1.50ISO	Internal	Right	Regular	0.250	1.50	NA	0.433	0.003	0.031	0.039				
11IR1.75ISO	Internal	Right	Regular	0.250	1.75	NA	0.433	0.004	0.035	0.430				
11IR2.00ISO	Internal	Right	Regular	0.250	2.00	NA	0.433	0.005	0.031	0.035				
16IR0.35ISO	Internal	Right	Regular	0.375	0.35	NA	0.630	0.001	0.031	0.012				
16IR0.40ISO	Internal	Right	Regular	0.375	0.40	NA	0.630	0.001	0.031	0.016				
16IR0.45ISO	Internal	Right	Regular	0.375	0.45	NA	0.630	0.001	0.031	0.016				
16IR0.50ISO	Internal	Right	Regular	0.375	0.50	NA	0.630	0.001	0.024	0.024				
16IR0.60ISO	Internal	Right	Regular	0.375	0.60	NA	0.630	0.001	0.024	0.024				
16IR0.70ISO	Internal	Right	Regular	0.375	0.70	NA	0.630	0.002	0.024	0.024				
16IR0.75ISO	Internal	Right	Regular	0.375	0.75	NA	0.630	0.002	0.024	0.024				
16IR0.80ISO	Internal	Right	Regular	0.375	0.80	NA	0.630	0.002	0.024	0.024				
16IR1.00ISO	Internal	Right	Regular	0.375	1.00	NA	0.630	0.002	0.024	0.028				
16IR1.25ISO	Internal	Right	Regular	0.375	1.25	NA	0.630	0.003	0.031	0.035				
16IR1.50ISO	Internal	Right	Regular	0.375	1.50	NA	0.630	0.003	0.031	0.039				
16IR1.75ISO	Internal	Right	Regular	0.375	1.75	NA	0.630	0.004	0.035	0.047				
16IR2.00ISO	Internal	Right	Regular	0.375	2.00	NA	0.630	0.005	0.039	0.051				
16IR2.50ISO	Internal	Right	Regular	0.375	2.50	NA	0.630	0.006	0.043	0.059				
16IR3.00ISO	Internal	Right	Regular	0.375	3.00	NA	0.630	0.007	0.043	0.059				
22IR3.50ISO	Internal	Right	Regular	0.500	3.50	NA	0.866	0.009	0.063	0.091				

● = P ● = M ● = K ● = N ● = S ○ = H

INTERNAL - RIGHT HAND, FULL PROFILE, DIN 13-12-1986 CLASS 6G

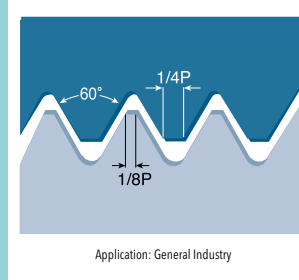
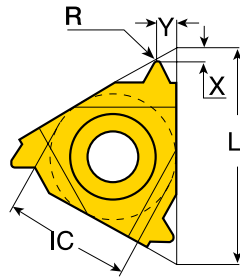

Designation	Thread Type	Hand	Insert Type	IC (inch)	Pitch (mm)	TPI	L (inch)	R (inch)	X (inch)	Y (inch)	Grade		
											TT7010	TT8010	TT9030
22IR4.00ISO	Internal	Right	Regular	0.500	4.00	NA	0.866	0.010	0.063	0.091			
22IR4.50ISO	Internal	Right	Regular	0.500	4.50	NA	0.866	0.011	0.063	0.094	●		●
22IR5.00ISO	Internal	Right	Regular	0.500	5.00	NA	0.866	0.013	0.063	0.091			●
27IR5.50ISO	Internal	Right	Regular	0.625	5.50	NA	1.063	0.014	0.063	0.091			
27IR6.00ISO	Internal	Right	Regular	0.625	6.00	NA	1.063	0.015	0.071	0.098	●		

● = P ● = M ● = K ● = N ● = S ○ = H

TOTHREAD ISO METRIC (M-TYPE)

INTERNAL - RIGHT HAND, PRESSED, FULL PROFILE, DIN 13-12-1986 CLASS 6G

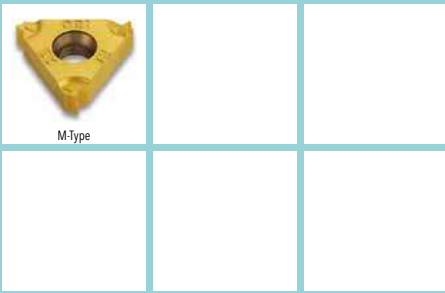

M-Type

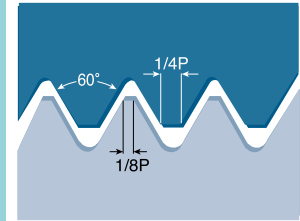
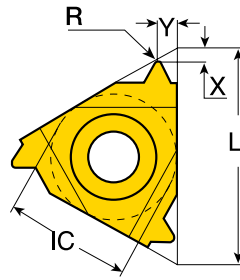

Application: General Industry

Designation	Thread Type	Hand	Insert Type	IC (inch)	Pitch (mm)	TPI	L (inch)	R (inch)	X (inch)	Y (inch)	Grade	T77010	T9030		
11IRM1.50ISO	Internal	Right	M-Type	0.250	1.50	NA	0.433	0.003	0.031	0.039					
16IRM1.00ISO	Internal	Right	M-Type	0.375	1.00	NA	0.630	0.002	0.024	0.028					
16IRM1.25ISO	Internal	Right	M-Type	0.375	1.25	NA	0.630	0.002	0.031	0.035					
16IRM1.50ISO	Internal	Right	M-Type	0.375	1.50	NA	0.630	0.003	0.031	0.039	●				
16IRM1.75ISO	Internal	Right	M-Type	0.375	1.75	NA	0.630	0.004	0.035	0.470					
16IRM2.00ISO	Internal	Right	M-Type	0.375	2.00	NA	0.630	0.004	0.039	0.510					
16IRM2.50ISO	Internal	Right	M-Type	0.375	2.50	NA	0.630	0.006	0.043	0.059					
16IRM3.00ISO	Internal	Right	M-Type	0.375	3.00	NA	0.630	0.007	0.043	0.059					

● = P ● = M ● = K ● = N ● = S ○ = H

TOTHREAD ISO METRIC (U-TYPE)

INTERNAL - FULL PROFILE, DIN 13-12-1986 CLASS 6G

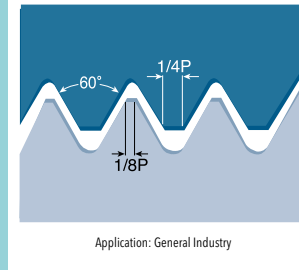
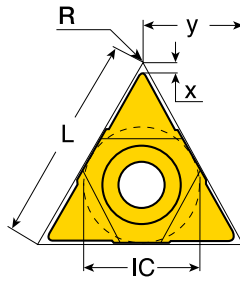
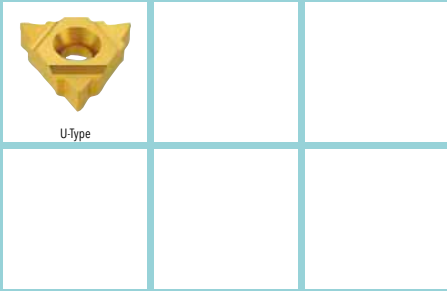

Designation	Thread Type	Hand	Insert Type	IC (inch)	Pitch (mm)	TPI	L (inch)	R (inch)	X (inch)	Y (inch)	Grade				
08UIRL2.00ISO	Internal	Neutral	U-Type	0.188	2.00	NA	0.315	0.005	0.039	0.157					
22UIRL5.50ISO	Internal	Neutral	U-Type	0.500	5.50	NA	0.866	0.014	0.094	0.433					
22UIRL6.00ISO	Internal	Neutral	U-Type	0.500	6.00	NA	0.866	0.015	0.083	0.433					
27UIRL8.00ISO	Internal	Neutral	U-Type	0.625	8.00	NA	1.063	0.021	0.094	0.539					

● = P ● = M ● = K ● = N ● = S ○ = H

EXTERNAL - LEFT HAND, FULL PROFILE (UN, UNC, UNF, UNEF) ANSI B1, 3M-1986 CLASS 2A

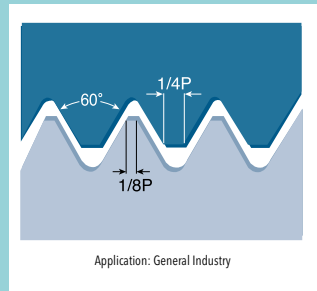
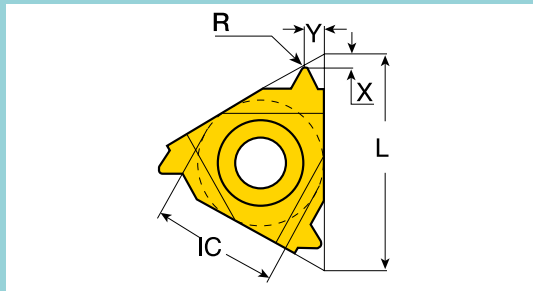
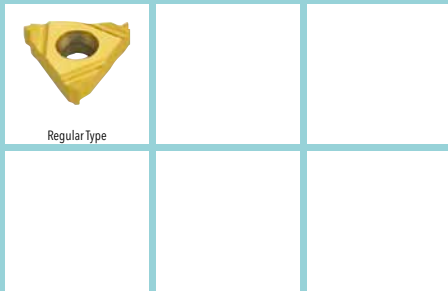

Designation	Thread Type	Hand	Insert Type	IC (inch)	Pitch (mm)	TPI	L (inch)	R (inch)	X (inch)	Y (inch)	Grade	T7010	T9030		
11EL16UN	External	Left	Regular	0.250	NA	16	0.433	0.007	0.035	0.043					
11EL18UN	External	Left	Regular	0.250	NA	18	0.433	0.007	0.031	0.039					
11EL20UN	External	Left	Regular	0.250	NA	20	0.433	0.006	0.031	0.035					
11EL24UN	External	Left	Regular	0.250	NA	24	0.433	0.005	0.028	0.031					
11EL28UN	External	Left	Regular	0.250	NA	28	0.433	0.004	0.024	0.028					
11EL32UN	External	Left	Regular	0.250	NA	32	0.433	0.004	0.024	0.024					
11EL36UN	External	Left	Regular	0.250	NA	36	0.433	0.003	0.024	0.024					
11EL40UN	External	Left	Regular	0.250	NA	40	0.433	0.002	0.024	0.024					
11EL44UN	External	Left	Regular	0.250	NA	44	0.433	0.002	0.024	0.024					
11EL48UN	External	Left	Regular	0.250	NA	48	0.433	0.002	0.024	0.024					
11EL56UN	External	Left	Regular	0.250	NA	56	0.433	0.002	0.028	0.016					
16EL12UN	External	Left	Regular	0.375	NA	12	0.630	0.010	0.043	0.055					
16EL16UN	External	Left	Regular	0.375	NA	16	0.630	0.007	0.035	0.043					
16EL18UN	External	Left	Regular	0.375	NA	18	0.630	0.007	0.031	0.039					
16EL20UN	External	Left	Regular	0.375	NA	20	0.630	0.006	0.031	0.035					
16EL28UN	External	Left	Regular	0.375	NA	28	0.630	0.004	0.024	0.028					
16EL36UN	External	Left	Regular	0.375	NA	36	0.630	0.003	0.024	0.024					
16EL40UN	External	Left	Regular	0.375	NA	40	0.630	0.002	0.024	0.024					
16EL8UN	External	Left	Regular	0.375	NA	8	0.630	0.016	0.047	0.063					
22EL5UN	External	Left	Regular	0.500	NA	5	0.866	0.026	0.067	0.098					
22EL6UN	External	Left	Regular	0.500	NA	6	0.866	0.022	0.063	0.091					
22EL7UN	External	Left	Regular	0.500	NA	7	0.866	0.019	0.063	0.091					
27EL4UN	External	Left	Regular	0.625	NA	4	1.063	0.033	0.083	0.118					
27EL4.5UN	External	Left	Regular	0.625	NA	4.5	1.063	0.030	0.075	0.106					

● = P ● = M ● = K ● = N ● = S ○ = H

EXTERNAL - RIGHT HAND, FULL PROFILE (UN, UNC, UNF, UNEF) ANSI B1, 3M-1986 CLASS 2A

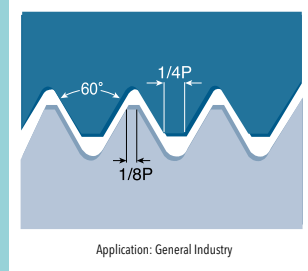
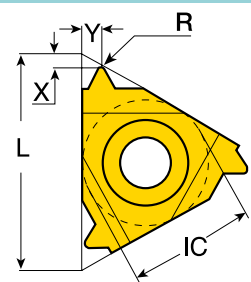

Designation	Thread Type	Hand	Insert Type	IC (inch)	Pitch (mm)	TPI	L (inch)	R (inch)	X (inch)	Y (inch)	Grade			
											TT7010	TT8010	TT9030	UF10
11ER16UN	External	Right	Regular	0.250	NA	16	0.433	0.007	0.035	0.043				
11ER18UN	External	Right	Regular	0.250	NA	18	0.433	0.007	0.031	0.039				
11ER20UN	External	Right	Regular	0.250	NA	20	0.433	0.006	0.031	0.035				
11ER24UN	External	Right	Regular	0.250	NA	24	0.433	0.005	0.028	0.031				
11ER28UN	External	Right	Regular	0.250	NA	28	0.433	0.004	0.024	0.028				
11ER32UN	External	Right	Regular	0.250	NA	32	0.433	0.004	0.024	0.024				
11ER36UN	External	Right	Regular	0.250	NA	36	0.433	0.003	0.024	0.024				
11ER40UN	External	Right	Regular	0.250	NA	40	0.433	0.002	0.024	0.024				
11ER44UN	External	Right	Regular	0.250	NA	44	0.433	0.002	0.024	0.024				
11ER48UN	External	Right	Regular	0.250	NA	48	0.433	0.002	0.024	0.024				
11ER56UN	External	Right	Regular	0.250	NA	56	0.433	0.002	0.028	0.160				
16ER10UN	External	Right	Regular	0.375	NA	10	0.630	0.013	0.043	0.059				
16ER11.5UN	External	Right	Regular	0.375	NA	11.5	0.630	0.011	0.043	0.059				
16ER11UN	External	Right	Regular	0.375	NA	11	0.630	0.011	0.043	0.059				
16ER12UN	External	Right	Regular	0.375	NA	12	0.630	0.010	0.043	0.055				
16ER13UN	External	Right	Regular	0.375	NA	13	0.630	0.009	0.039	0.051				
16ER14UN	External	Right	Regular	0.375	NA	14	0.630	0.009	0.039	0.047				
16ER16UN	External	Right	Regular	0.375	NA	16	0.630	0.007	0.035	0.043				
16ER18UN	External	Right	Regular	0.375	NA	18	0.630	0.007	0.031	0.039				
16ER20UN	External	Right	Regular	0.375	NA	20	0.630	0.006	0.031	0.035				
16ER24UN	External	Right	Regular	0.375	NA	24	0.630	0.005	0.028	0.031				
16ER28UN	External	Right	Regular	0.375	NA	28	0.630	0.004	0.024	0.028				
16ER32UN	External	Right	Regular	0.375	NA	32	0.630	0.004	0.024	0.024				
16ER36UN	External	Right	Regular	0.375	NA	36	0.630	0.003	0.024	0.024				
16ER40UN	External	Right	Regular	0.375	NA	40	0.630	0.002	0.024	0.024				
16ER48UN	External	Right	Regular	0.375	NA	48	0.630	0.002	0.024	0.024				
16ER56UN	External	Right	Regular	0.375	NA	56	0.630	0.002	0.028	0.016				
16ER8UN	External	Right	Regular	0.375	NA	8	0.630	0.016	0.047	0.063				
16ER9UN	External	Right	Regular	0.375	NA	9	0.630	0.014	0.047	0.067				

● = P ● = M ● = K ● = N ● = S ○ = H

TOTHREAD AMERICAN UN (M-TYPE)

EXTERNAL - RIGHT HAND, PRESSED, FULL PROFILE (UN, UNC, UNF, UNEF) ANSI B1, 3M-1986 CLASS 2A



M-Type

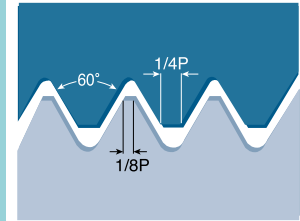
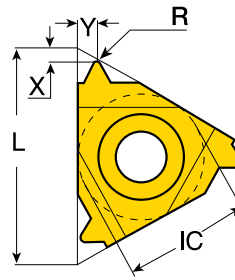

Application: General Industry

Designation	Thread Type	Hand	Insert Type	IC (inch)	TPI	L (inch)	R (inch)	X (inch)	Y (inch)	Grade	T77010	T9030		
16ERM8UN	External	Right	M-Type	0.375	8	0.630	0.016	0.047	0.063		●	●		
16ERM12UN	External	Right	M-Type	0.375	12	0.630	0.010	0.043	0.055		●	●		
16ERM13UN	External	Right	M-Type	0.375	13	0.630	0.009	0.039	0.051			●		
16ERM14UN	External	Right	M-Type	0.375	14	0.630	0.009	0.039	0.047			●		
16ERM16UN	External	Right	M-Type	0.375	16	0.630	0.007	0.035	0.043			●		
16ERM18UN	External	Right	M-Type	0.375	18	0.630	0.006	0.031	0.039			●		
16ERM20UN	External	Right	M-Type	0.375	20	0.630	0.006	0.031	0.035		●	●		
16ERM24UN	External	Right	M-Type	0.375	24	0.630	0.004	0.028	0.031		●	●		

● = P ● = M ● = K ● = N ● = S ○ = H

TOTHREAD AMERICAN UN (U-TYPE)

EXTERNAL - FULL PROFILE (UN, UNC, UNF, UNEF) ANSI B1, 3M-1986 CLASS 2A

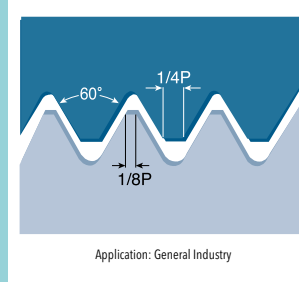
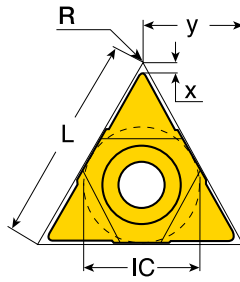

Designation	Thread Type	Hand	Insert Type	IC (inch)	TPI	L (inch)	R (inch)	X (inch)	Y (inch)	Grade				
27UERL3UN	External	Neutral	U-Type	0.625	3	1.063	0.045	0.098	0.539					
22UERL4UN	External	Neutral	U-Type	0.500	4	0.866	0.033	0.079	0.433					
22UERL4.5UN	External	Neutral	U-Type	0.500	4.5	0.866	0.030	0.079	0.433					

● = P ● = M ● = K ● = N ● = S ○ = H

INTERNAL - LEFT HAND, FULL PROFILE (UN, UNC, UNF, UNEF) ANSI B1, 3M-1986 CLASS 2A

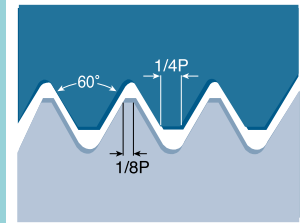
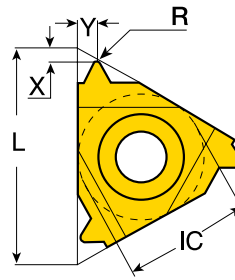

Application: General Industry

Designation	Thread Type	Hand	Insert Type	IC (inch)	TPI	L (inch)	R (inch)	X (inch)	Y (inch)	Grade	TT9030			
06IL18UN	Internal	Left	Regular	0.156	18	0.236	0.003	0.024	0.024					
06IL20UN	Internal	Left	Regular	0.156	20	0.236	0.002	0.024	0.024					
06IL24UN	Internal	Left	Regular	0.156	24	0.236	0.002	0.020	0.024					
06IL28UN	Internal	Left	Regular	0.156	28	0.236	0.002	0.020	0.020					
06IL32UN	Internal	Left	Regular	0.156	32	0.236	0.002	0.020	0.020					
08IL14UN	Internal	Left	Regular	0.188	14	0.315	0.004	0.024	0.031					
08IL16UN	Internal	Left	Regular	0.188	16	0.315	0.004	0.024	0.028					
08IL18UN	Internal	Left	Regular	0.188	18	0.315	0.003	0.024	0.028					
08IL20UN	Internal	Left	Regular	0.188	20	0.315	0.002	0.024	0.028					
08IL24UN	Internal	Left	Regular	0.188	24	0.315	0.002	0.024	0.024					
08IL28UN	Internal	Left	Regular	0.188	28	0.315	0.002	0.024	0.024					
08IL32UN	Internal	Left	Regular	0.188	32	0.315	0.002	0.024	0.020					
11IL14UN	Internal	Left	Regular	0.250	14	0.433	0.004	0.035	0.043					
11IL16UN	Internal	Left	Regular	0.250	16	0.433	0.004	0.035	0.043					
11IL18UN	Internal	Left	Regular	0.250	18	0.433	0.003	0.031	0.039					
11IL20UN	Internal	Left	Regular	0.250	20	0.433	0.002	0.031	0.035					
11IL24UN	Internal	Left	Regular	0.250	24	0.433	0.002	0.028	0.031					
11IL28UN	Internal	Left	Regular	0.250	28	0.433	0.002	0.024	0.028					
11IL32UN	Internal	Left	Regular	0.250	32	0.433	0.002	0.024	0.024					
11IL36UN	Internal	Left	Regular	0.250	36	0.433	0.002	0.024	0.024					
11IL40UN	Internal	Left	Regular	0.250	40	0.433	0.001	0.024	0.024					
11IL48UN	Internal	Left	Regular	0.250	48	0.433	0.001	0.024	0.024					
11IL56UN	Internal	Left	Regular	0.250	56	0.433	0.001	0.028	0.016					
11IL64UN	Internal	Left	Regular	0.250	64	0.433	0.001	0.031	0.016					
11IL72UN	Internal	Left	Regular	0.250	72	0.433	0.001	0.031	0.012					
16IL8UN	Internal	Left	Regular	0.375	8	0.630	0.007	0.043	0.059					●
16IL9UN	Internal	Left	Regular	0.375	9	0.630	0.007	0.047	0.067					●
16IL10UN	Internal	Left	Regular	0.375	10	0.630	0.006	0.043	0.059					●
16IL11UN	Internal	Left	Regular	0.375	11	0.630	0.006	0.043	0.059					●
16IL11.5UN	Internal	Left	Regular	0.375	11.5	0.630	0.005	0.043	0.059					●
16IL12UN	Internal	Left	Regular	0.375	12	0.630	0.005	0.043	0.055					●
16IL13UN	Internal	Left	Regular	0.375	13	0.630	0.004	0.039	0.051					●
16IL14UN	Internal	Left	Regular	0.375	14	0.630	0.004	0.035	0.047					●
16IL16UN	Internal	Left	Regular	0.375	16	0.630	0.004	0.035	0.043					●
16IL18UN	Internal	Left	Regular	0.375	18	0.630	0.003	0.031	0.039					●
16IL20UN	Internal	Left	Regular	0.375	20	0.630	0.002	0.031	0.035					
16IL24UN	Internal	Left	Regular	0.375	24	0.630	0.002	0.028	0.031					
16IL28UN	Internal	Left	Regular	0.375	28	0.630	0.002	0.024	0.028					
16IL32UN	Internal	Left	Regular	0.375	32	0.630	0.002	0.024	0.024					

● = P ● = M ● = K ● = N ● = S ○ = H

INTERNAL - LEFT HAND, FULL PROFILE (UN, UNC, UNF, UNEF) ANSI B1, 3M-1986 CLASS 2A



Regular Type

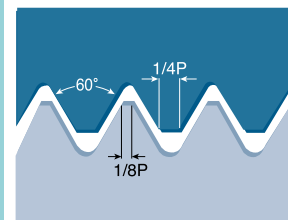
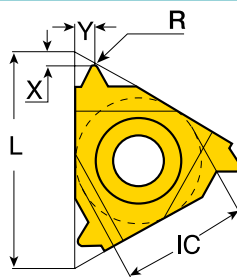

Application: General Industry

Designation	Thread Type	Hand	Insert Type	IC (inch)	TPI	L (inch)	R (inch)	X (inch)	Y (inch)	Grade	TT9030			
16IL36UN	Internal	Left	Regular	0.375	36	0.630	0.002	0.024	0.024					
16IL40UN	Internal	Left	Regular	0.375	40	0.630	0.001	0.024	0.024					
16IL44UN	Internal	Left	Regular	0.375	44	0.630	0.001	0.024	0.024					
16IL56UN	Internal	Left	Regular	0.375	56	0.630	0.001	0.028	0.016					
22IL5UN	Internal	Left	Regular	0.500	5	0.866	0.013	0.063	0.091					
22IL6UN	Internal	Left	Regular	0.500	6	0.866	0.010	0.063	0.091					
22IL7UN	Internal	Left	Regular	0.500	7	0.866	0.009	0.063	0.091					
27IL4UN	Internal	Left	Regular	0.625	4	1.063	0.016	0.071	0.106					
27IL4.5UN	Internal	Left	Regular	0.625	4.5	1.063	0.014	0.067	0.094					

● = P ● = M ● = K ● = N ● = S ○ = H



TOTHREAD UN (UN, UNC, UNF, UNEF)

INTERNAL - RIGHT HAND, FULL PROFILE (UN, UNC, UNF, UNEF) ANSI B1, 3M - 1986 CLASS 2A

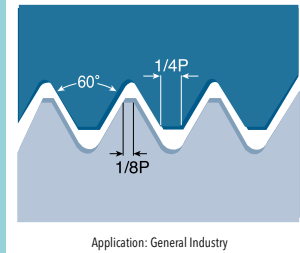
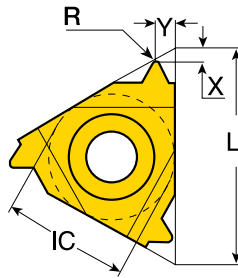

Designation	Thread Type	Hand	Insert Type	IC (inch)	TPI	L (inch)	R (inch)	X (inch)	Y (inch)	Grade	TT6010	TT7010	TT8010	TT9030
06IR18UN	Internal	Right	Regular	0.156	18	0.236	0.003	0.024	0.024					
06IR20UN	Internal	Right	Regular	0.156	20	0.236	0.002	0.024	0.024					●
06IR24UN	Internal	Right	Regular	0.156	24	0.236	0.002	0.020	0.024					●
06IR28UN	Internal	Right	Regular	0.156	28	0.236	0.002	0.020	0.020					
06IR32UN	Internal	Right	Regular	0.156	32	0.236	0.002	0.020	0.020					●
08IR14UN	Internal	Right	Regular	0.188	14	0.315	0.004	0.024	0.031					●
08IR16UN	Internal	Right	Regular	0.188	16	0.315	0.004	0.024	0.028					●
08IR18UN	Internal	Right	Regular	0.188	18	0.315	0.003	0.024	0.028					●
08IR20UN	Internal	Right	Regular	0.188	20	0.315	0.002	0.024	0.028					●
08IR24UN	Internal	Right	Regular	0.188	24	0.315	0.002	0.024	0.024					●
08IR28UN	Internal	Right	Regular	0.188	28	0.315	0.002	0.024	0.024					●
08IR32UN	Internal	Right	Regular	0.188	32	0.315	0.002	0.024	0.020					
11IR14UN	Internal	Right	Regular	0.250	14	0.433	0.004	0.035	0.043					●
11IR16UN	Internal	Right	Regular	0.250	16	0.433	0.004	0.035	0.043					●
11IR18UN	Internal	Right	Regular	0.250	18	0.433	0.003	0.031	0.039					●
11IR20UN	Internal	Right	Regular	0.250	20	0.433	0.002	0.031	0.035					●
11IR24UN	Internal	Right	Regular	0.250	24	0.433	0.002	0.028	0.031					●
11IR28UN	Internal	Right	Regular	0.250	28	0.433	0.002	0.024	0.028					
11IR32UN	Internal	Right	Regular	0.250	32	0.433	0.002	0.024	0.024					●
11IR36UN	Internal	Right	Regular	0.250	36	0.433	0.002	0.024	0.024					
11IR40UN	Internal	Right	Regular	0.250	40	0.433	0.001	0.024	0.024					
11IR48UN	Internal	Right	Regular	0.250	48	0.433	0.001	0.024	0.024					
11IR56UN	Internal	Right	Regular	0.250	56	0.433	0.001	0.028	0.016					
11IR64UN	Internal	Right	Regular	0.250	64	0.433	0.001	0.031	0.016					
11IR72UN	Internal	Right	Regular	0.250	72	0.433	0.001	0.031	0.012					
16IR8UN	Internal	Right	Regular	0.375	8	0.630	0.007	0.043	0.059					●
16IR9UN	Internal	Right	Regular	0.375	9	0.630	0.007	0.047	0.067					●
16IR10UN	Internal	Right	Regular	0.375	10	0.630	0.006	0.043	0.059					●
16IR11UN	Internal	Right	Regular	0.375	11	0.630	0.006	0.043	0.059		●			
16IR11.5UN	Internal	Right	Regular	0.375	11.5	0.630	0.005	0.043	0.059					●
16IR12UN	Internal	Right	Regular	0.375	12	0.630	0.005	0.043	0.055					●
16IR13UN	Internal	Right	Regular	0.375	13	0.630	0.004	0.039	0.051					
16IR14UN	Internal	Right	Regular	0.375	14	0.630	0.004	0.035	0.047					●
16IR16UN	Internal	Right	Regular	0.375	16	0.630	0.004	0.035	0.043					●
16IR18UN	Internal	Right	Regular	0.375	18	0.630	0.003	0.031	0.039					●
16IR20UN	Internal	Right	Regular	0.375	20	0.630	0.002	0.031	0.035		●			●
16IR24UN	Internal	Right	Regular	0.375	24	0.630	0.002	0.028	0.031			●		●
16IR28UN	Internal	Right	Regular	0.375	28	0.630	0.002	0.024	0.028					●
16IR32UN	Internal	Right	Regular	0.375	32	0.630	0.002	0.024	0.024			●		●

● = P ● = M ● = K ● = N ● = S ○ = H

TOTHREAD UN (UN, UNC, UNF, UNEF)

INTERNAL - RIGHT HAND, FULL PROFILE (UN, UNC, UNF, UNEF) ANSI B1, 3M - 1986 CLASS 2A

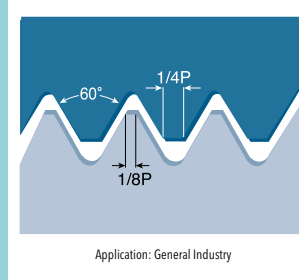
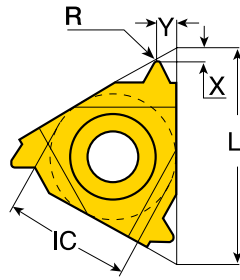

Designation	Thread Type	Hand	Insert Type	IC (inch)	TPI	L (inch)	R (inch)	X (inch)	Y (inch)	Grade			
										T6010	T7010	T8010	T9030
16IR36UN	Internal	Right	Regular	0.375	36	0.630	0.002	0.024	0.024				
16IR40UN	Internal	Right	Regular	0.375	40	0.630	0.001	0.024	0.024				
16IR44UN	Internal	Right	Regular	0.375	44	0.630	0.001	0.024	0.024				●
16IR56UN	Internal	Right	Regular	0.375	56	0.630	0.001	0.028	0.016				
22IR5UN	Internal	Right	Regular	0.500	5	0.866	0.013	0.063	0.091				
22IR6UN	Internal	Right	Regular	0.500	6	0.866	0.010	0.063	0.091				●
22IR7UN	Internal	Right	Regular	0.500	7	0.866	0.009	0.063	0.091				●
27IR4UN	Internal	Right	Regular	0.625	4	1.063	0.016	0.071	0.106				●
27IR4.5UN	Internal	Right	Regular	0.625	4.5	1.063	0.014	0.067	0.094			●	

● = P ● = M ● = K ● = N ● = S ○ = H

INTERNAL - RIGHT HAND, PRESSED, FULL PROFILE (UN, UNC, UNF, UNEF) ANSI B1, 3M-1986 CLASS 2A

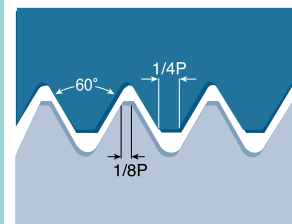
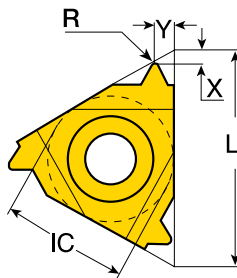

Application: General Industry

Designation	Thread Type	Hand	Insert Type	IC (inch)	TPI	L (inch)	R (inch)	X (inch)	Y (inch)	Grade	T77010	T9030		
16IRM8UN	Internal	Right	M-Type	0.375	8	0.630	0.008	0.043	0.059	●	●			
16IRM12UN	Internal	Right	M-Type	0.375	12	0.630	0.005	0.043	0.055		●			
16IRM14UN	Internal	Right	M-Type	0.375	14	0.630	0.004	0.035	0.047		●			
16IRM16UN	Internal	Right	M-Type	0.375	16	0.630	0.004	0.035	0.043		●			
16IRM18UN	Internal	Right	M-Type	0.375	18	0.630	0.003	0.031	0.039	●	●			
16IRM20UN	Internal	Right	M-Type	0.375	20	0.630	0.002	0.031	0.035		●			

● = P ● = M ● = K ● = N ● = S ○ = H

INTERNAL - FULL PROFILE (UN, UNC, UNF, UNEF) ANSI B1, 3M-1986 CLASS 2A



U-type

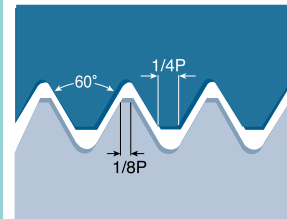
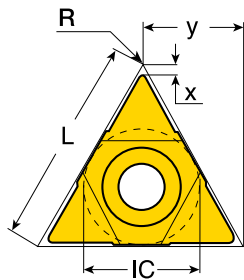

Application: General Industry

Designation	Thread Type	Hand	Insert Type	IC (inch)	TPI	L (inch)	R (inch)	X (inch)	Y (inch)	Grade		
										TT7010	TT8010	TT9030
08UIRL11UN	Internal	Neutral	Regular	0.188	11	0.315	0.006	0.035	0.157		●	
08UIRL12UN	Internal	Neutral	Regular	0.188	12	0.315	0.010	0.035	0.157			
08UIRL13UN	Internal	Neutral	Regular	0.188	13	0.315	0.004	0.039	0.157			●
08UIRL14UN	Internal	Neutral	Regular	0.188	14	0.315	0.008	0.039	0.157			
27UIRL3UN	Internal	Neutral	Regular	0.625	3	1.063	0.022	0.106	0.539			
22UIRL4UN	Internal	Neutral	Regular	0.500	4	0.866	0.016	0.094	0.433			
22UIRL4.5UN	Internal	Neutral	Regular	0.500	4.5	0.866	0.014	0.094	0.433	●		

● = P ● = M ● = K ● = N ● = S ○ = H

EXTERNAL - LEFT HAND, FULL PROFILE (BSW, BSF, BSP) BS.84-1956 DIN 259 MEDIUM CLASS

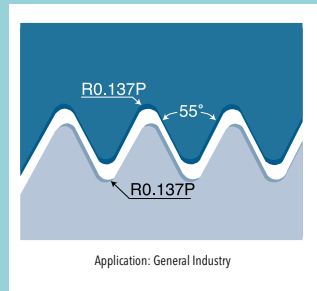
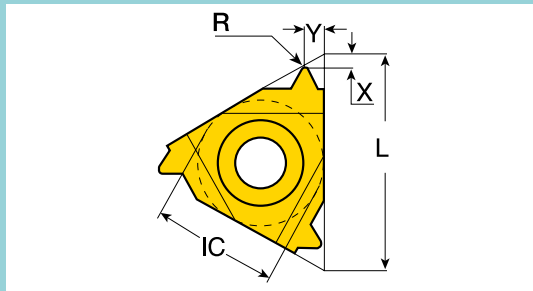
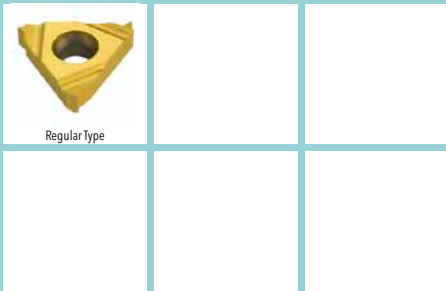

Designation	Thread Type	Hand	Insert Type	IC (inch)	TPI	L (inch)	R (inch)	X (inch)	Y (inch)	Grade	T17010	T19030		
11EL14W	External	Left	Regular	0.250	14	0.433	0.008	0.039	0.047					
11EL16W	External	Left	Regular	0.250	16	0.433	0.007	0.035	0.043					
11EL18W	External	Left	Regular	0.250	18	0.433	0.006	0.031	0.039					
11EL19W	External	Left	Regular	0.250	19	0.433	0.006	0.031	0.039					
11EL20W	External	Left	Regular	0.250	20	0.433	0.006	0.031	0.035					
11EL22W	External	Left	Regular	0.250	22	0.433	0.005	0.031	0.035					
11EL24W	External	Left	Regular	0.250	24	0.433	0.004	0.028	0.031					
11EL26W	External	Left	Regular	0.250	26	0.433	0.004	0.028	0.031					
11EL28W	External	Left	Regular	0.250	28	0.433	0.004	0.024	0.028					
11EL32W	External	Left	Regular	0.250	32	0.433	0.004	0.024	0.024					
11EL36W	External	Left	Regular	0.250	36	0.433	0.003	0.024	0.024					
11EL48W	External	Left	Regular	0.250	48	0.433	0.002	0.024	0.024					
16EL8W	External	Left	Regular	0.375	8	0.630	0.015	0.047	0.059					
16EL9W	External	Left	Regular	0.375	9	0.630	0.013	0.047	0.067					
16EL10W	External	Left	Regular	0.375	10	0.630	0.012	0.043	0.059					
16EL11W	External	Left	Regular	0.375	11	0.630	0.011	0.043	0.059		●	●		
16EL12W	External	Left	Regular	0.375	12	0.630	0.010	0.043	0.055					
16EL14W	External	Left	Regular	0.375	14	0.630	0.008	0.039	0.047			●		
16EL16W	External	Left	Regular	0.375	16	0.630	0.007	0.035	0.043					
16EL18W	External	Left	Regular	0.375	18	0.630	0.006	0.031	0.039					
16EL19W	External	Left	Regular	0.375	19	0.630	0.006	0.031	0.039			●		
16EL20W	External	Left	Regular	0.375	20	0.630	0.006	0.031	0.035					
16EL22W	External	Left	Regular	0.375	22	0.630	0.005	0.031	0.035					
16EL24W	External	Left	Regular	0.375	24	0.630	0.004	0.028	0.031					
16EL26W	External	Left	Regular	0.375	26	0.630	0.004	0.028	0.031					
16EL28W	External	Left	Regular	0.375	28	0.630	0.004	0.024	0.028					
16EL32W	External	Left	Regular	0.375	32	0.630	0.004	0.024	0.024					
16EL40W	External	Left	Regular	0.375	40	0.630	0.002	0.024	0.024					
16EL56W	External	Left	Regular	0.375	56	0.630	0.002	0.028	0.016					
22EL5W	External	Left	Regular	0.500	5	0.866	0.026	0.067	0.094					
22EL6W	External	Left	Regular	0.500	6	0.866	0.020	0.063	0.091					
22EL7W	External	Left	Regular	0.500	7	0.866	0.018	0.063	0.091					
27EL4.5W	External	Left	Regular	0.625	4.5	1.063	0.029	0.071	0.102					

● = P ● = M ● = K ● = N ● = S ○ = H

EXTERNAL - RIGHT HAND, FULL PROFILE (BSW, BSF, BSP) BS.84-1956 DIN 259 MEDIUM CLASS

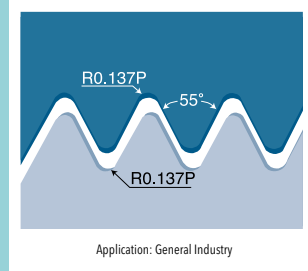
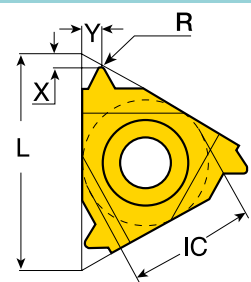

Designation	Thread Type	Hand	Insert Type	IC (inch)	TPI	L (inch)	R (inch)	X (inch)	Y (inch)	Grade	TT9030			
11ER14W	External	Right	Regular	0.250	14	0.433	0.008	0.039	0.047					
11ER16W	External	Right	Regular	0.250	16	0.433	0.007	0.035	0.043					
11ER18W	External	Right	Regular	0.250	18	0.433	0.006	0.031	0.039					
11ER19W	External	Right	Regular	0.250	19	0.433	0.006	0.031	0.039					
11ER20W	External	Right	Regular	0.250	20	0.433	0.006	0.031	0.035					
11ER22W	External	Right	Regular	0.250	22	0.433	0.005	0.031	0.035					
11ER24W	External	Right	Regular	0.250	24	0.433	0.004	0.028	0.031					
11ER26W	External	Right	Regular	0.250	26	0.433	0.004	0.028	0.031					
11ER28W	External	Right	Regular	0.250	28	0.433	0.004	0.024	0.028					
11ER32W	External	Right	Regular	0.250	32	0.433	0.004	0.024	0.024					
11ER36W	External	Right	Regular	0.250	36	0.433	0.003	0.024	0.024					
11ER48W	External	Right	Regular	0.250	48	0.433	0.002	0.024	0.024					
16ER8W	External	Right	Regular	0.375	8	0.630	0.015	0.047	0.059					
16ER9W	External	Right	Regular	0.375	9	0.630	0.013	0.047	0.067					
16ER10W	External	Right	Regular	0.375	10	0.630	0.012	0.043	0.059					
16ER11W	External	Right	Regular	0.375	11	0.630	0.011	0.043	0.059					
16ER12W	External	Right	Regular	0.375	12	0.630	0.010	0.043	0.055					
16ER14W	External	Right	Regular	0.375	14	0.630	0.008	0.039	0.047					
16ER16W	External	Right	Regular	0.375	16	0.630	0.007	0.035	0.043					
16ER18W	External	Right	Regular	0.375	18	0.630	0.006	0.031	0.039					
16ER19W	External	Right	Regular	0.375	19	0.630	0.006	0.031	0.039					
16ER20W	External	Right	Regular	0.375	20	0.630	0.006	0.031	0.035					
16ER22W	External	Right	Regular	0.375	22	0.630	0.005	0.031	0.035					
16ER24W	External	Right	Regular	0.375	24	0.630	0.004	0.028	0.031					
16ER26W	External	Right	Regular	0.375	26	0.630	0.004	0.028	0.031					
16ER28W	External	Right	Regular	0.375	28	0.630	0.004	0.024	0.028					
16ER32W	External	Right	Regular	0.375	32	0.630	0.004	0.024	0.024					
16ER40W	External	Right	Regular	0.375	40	0.630	0.002	0.024	0.024					
16ER56W	External	Right	Regular	0.375	56	0.630	0.002	0.028	0.016					
22ER5W	External	Right	Regular	0.500	5	0.866	0.026	0.067	0.094					
22ER6W	External	Right	Regular	0.500	6	0.866	0.020	0.063	0.091					
22ER7W	External	Right	Regular	0.500	7	0.866	0.018	0.063	0.091					
27ER4W	External	Right	Regular	0.625	4	1.063	0.032	0.079	0.114					
27ER4.5W	External	Right	Regular	0.625	4.5	1.063	0.029	0.071	0.102					

● = P ● = M ● = K ● = N ● = S ○ = H

TOTHREAD WHITWORTH (M-TYPE)

EXTERNAL - RIGHT HAND, PRESSED, FULL PROFILE (BSW, BSF, BSP) BS.84-1956 DIN 259 MEDIUM CLASS

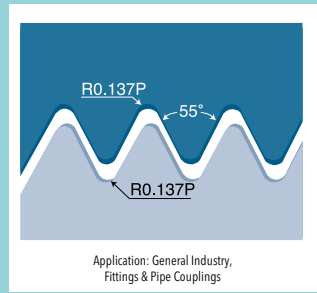
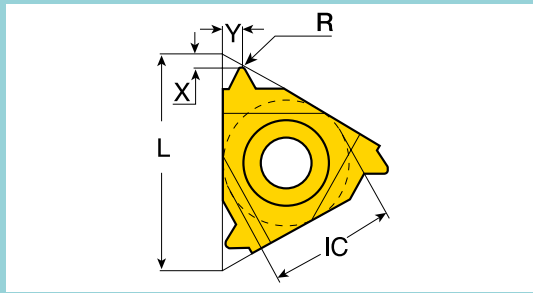
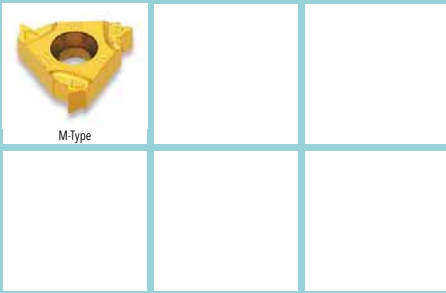

Designation	Thread Type	Hand	Insert Type	IC (inch)	TPI	L (inch)	R (inch)	X (inch)	Y (inch)	Grade	TT9030			
16ERM11W	External	Right	M-Type	0.375	11	0.630	0.012	0.043	0.059	●				
16ERM14W	External	Right	M-Type	0.375	14	0.630	0.009	0.039	0.047	●				
16ERM16W	External	Right	M-Type	0.375	16	0.630	0.008	0.035	0.043	●				
16ERM19W	External	Right	M-Type	0.375	19	0.630	0.003	0.031	0.039	●				

● = P ● = M ● = K ● = N ● = S ○ = H

Indersoll



INTERNAL - LEFT HAND, FULL PROFILE (BSW, BSF, BSP) BS.84-1956 DIN 259 MEDIUM CLASS

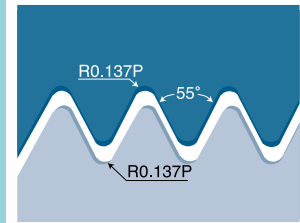
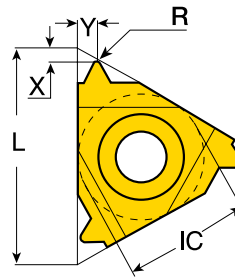

Application: General Industry,
Fittings & Pipe Couplings

Designation	Thread Type	Hand	Insert Type	IC (inch)	TPI	L (inch)	R (inch)	X (inch)	Y (inch)	Grade	TT9030			
06IL18W	Internal	Left	Regular	0.156	18	0.236	0.006	0.024	0.028					
06IL20W	Internal	Left	Regular	0.156	20	0.236	0.006	0.024	0.028					
06IL22W	Internal	Left	Regular	0.156	22	0.236	0.005	0.024	0.024					
06IL26W	Internal	Left	Regular	0.156	26	0.236	0.004	0.028	0.024					
08IL16W	Internal	Left	Regular	0.188	16	0.315	0.007	0.024	0.028					
08IL18W	Internal	Left	Regular	0.188	18	0.315	0.006	0.024	0.028					
08IL19W	Internal	Left	Regular	0.188	19	0.315	0.006	0.024	0.028					
08IL20W	Internal	Left	Regular	0.188	20	0.315	0.006	0.024	0.028					
08IL24W	Internal	Left	Regular	0.188	24	0.315	0.004	0.024	0.024					
08IL28W	Internal	Left	Regular	0.188	28	0.315	0.004	0.024	0.024					
11IL14W	Internal	Left	Regular	0.250	14	0.433	0.008	0.035	0.043					
11IL16W	Internal	Left	Regular	0.250	16	0.433	0.007	0.035	0.043					
11IL18W	Internal	Left	Regular	0.250	18	0.433	0.006	0.031	0.039					
11IL19W	Internal	Left	Regular	0.250	19	0.433	0.006	0.031	0.039					
11IL20W	Internal	Left	Regular	0.250	20	0.433	0.006	0.031	0.035					
11IL22W	Internal	Left	Regular	0.250	22	0.433	0.005	0.031	0.035					
11IL24W	Internal	Left	Regular	0.250	24	0.433	0.004	0.028	0.031					
11IL26W	Internal	Left	Regular	0.250	26	0.433	0.004	0.028	0.031					
11IL28W	Internal	Left	Regular	0.250	28	0.433	0.004	0.024	0.028					
11IL32W	Internal	Left	Regular	0.250	32	0.433	0.004	0.024	0.024					
11IL36W	Internal	Left	Regular	0.250	36	0.433	0.003	0.024	0.024					
11IL48W	Internal	Left	Regular	0.250	48	0.433	0.002	0.024	0.024					
16IL8W	Internal	Left	Regular	0.375	8	0.630	0.015	0.047	0.059					
16IL9W	Internal	Left	Regular	0.375	9	0.630	0.013	0.047	0.067					
16IL10W	Internal	Left	Regular	0.375	10	0.630	0.012	0.043	0.059					
16IL11W	Internal	Left	Regular	0.375	11	0.630	0.011	0.043	0.059					
16IL12W	Internal	Left	Regular	0.375	12	0.630	0.010	0.043	0.055					
16IL14W	Internal	Left	Regular	0.375	14	0.630	0.008	0.039	0.047					
16IL16W	Internal	Left	Regular	0.375	16	0.630	0.007	0.035	0.043					
16IL18W	Internal	Left	Regular	0.375	18	0.630	0.006	0.031	0.039					
16IL19W	Internal	Left	Regular	0.375	19	0.630	0.006	0.031	0.039					
16IL20W	Internal	Left	Regular	0.375	20	0.630	0.006	0.031	0.035					
16IL22W	Internal	Left	Regular	0.375	22	0.630	0.005	0.031	0.035					
16IL24W	Internal	Left	Regular	0.375	24	0.630	0.004	0.028	0.031					
16IL26W	Internal	Left	Regular	0.375	26	0.630	0.004	0.028	0.031					
16IL28W	Internal	Left	Regular	0.375	28	0.630	0.004	0.024	0.028					
16IL32W	Internal	Left	Regular	0.375	32	0.630	0.004	0.024	0.024					
16IL40W	Internal	Left	Regular	0.375	40	0.630	0.002	0.024	0.024					
16IL56W	Internal	Left	Regular	0.375	56	0.630	0.002	0.028	0.016					

● = P ● = M ● = K ● = N ● = S ○ = H

INTERNAL - LEFT HAND, FULL PROFILE (BSW, BSF, BSP) BS.84-1956 DIN 259 MEDIUM CLASS



Regular Type

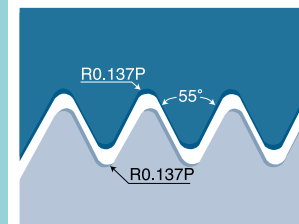
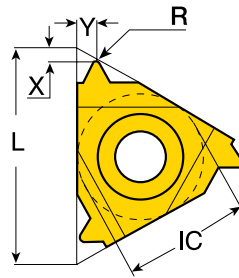

Application: General Industry, Fittings & Pipe Couplings

Designation	Thread Type	Hand	Insert Type	IC (inch)	TPI	L (inch)	R (inch)	X (inch)	Y (inch)	Grade	TT9030			
22IL5W	Internal	Left	Regular	0.500	5	0.866	0.026	0.067	0.094					
22IL6W	Internal	Left	Regular	0.500	6	0.866	0.021	0.063	0.091					
22IL7W	Internal	Left	Regular	0.500	7	0.866	0.018	0.063	0.091					
27IL4W	Internal	Left	Regular	0.625	4	1.063	0.032	0.079	0.114					
27IL4.5W	Internal	Left	Regular	0.625	4.5	1.063	0.029	0.071	0.102					

● = P ● = M ● = K ● = N ● = S ○ = H

INTERNAL - RIGHT HAND, FULL PROFILE (BSW, BSF, BSP) BS.84-1956 DIN 259 MEDIUM CLASS

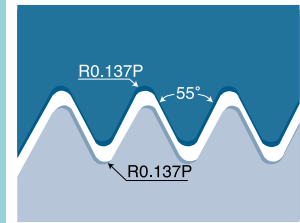
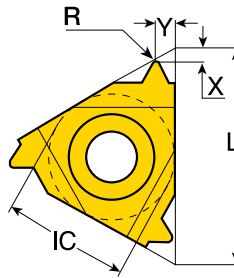

Application: General Industry, Fittings & Pipe Couplings

Designation	Thread Type	Hand	Insert Type	IC (inch)	TPI	L (inch)	R (inch)	X (inch)	Y (inch)	Grade	T18010	T19030		
06IR18W	Internal	Right	Regular	0.156	18	0.236	0.006	0.024	0.028					
06IR20W	Internal	Right	Regular	0.156	20	0.236	0.006	0.024	0.028					
06IR22W	Internal	Right	Regular	0.156	22	0.236	0.005	0.024	0.024					
06IR26W	Internal	Right	Regular	0.156	26	0.236	0.004	0.028	0.024					
08IR16W	Internal	Right	Regular	0.188	16	0.315	0.007	0.024	0.028					
08IR18W	Internal	Right	Regular	0.188	18	0.315	0.006	0.024	0.028					
08IR19W	Internal	Right	Regular	0.188	19	0.315	0.006	0.024	0.028		●			
08IR20W	Internal	Right	Regular	0.188	20	0.315	0.006	0.024	0.028					
08IR24W	Internal	Right	Regular	0.188	24	0.315	0.004	0.024	0.024					
08IR28W	Internal	Right	Regular	0.188	28	0.315	0.004	0.024	0.024					
11IR14W	Internal	Right	Regular	0.250	14	0.433	0.008	0.035	0.043			●		
11IR16W	Internal	Right	Regular	0.250	16	0.433	0.007	0.035	0.043					
11IR18W	Internal	Right	Regular	0.250	18	0.433	0.006	0.031	0.039			●		
11IR19W	Internal	Right	Regular	0.250	19	0.433	0.006	0.031	0.039			●		
11IR20W	Internal	Right	Regular	0.250	20	0.433	0.006	0.031	0.035					
11IR22W	Internal	Right	Regular	0.250	22	0.433	0.005	0.031	0.035					
11IR24W	Internal	Right	Regular	0.250	24	0.433	0.004	0.028	0.031					
11IR26W	Internal	Right	Regular	0.250	26	0.433	0.004	0.028	0.031					
11IR28W	Internal	Right	Regular	0.250	28	0.433	0.004	0.024	0.028					
11IR32W	Internal	Right	Regular	0.250	32	0.433	0.004	0.024	0.024					
11IR36W	Internal	Right	Regular	0.250	36	0.433	0.003	0.024	0.024					
11IR48W	Internal	Right	Regular	0.250	48	0.433	0.002	0.024	0.024					
16IR8W	Internal	Right	Regular	0.375	8	0.630	0.015	0.047	0.059			●		
16IR9W	Internal	Right	Regular	0.375	9	0.630	0.013	0.047	0.067					
16IR10W	Internal	Right	Regular	0.375	10	0.630	0.012	0.043	0.059			●		
16IR11W	Internal	Right	Regular	0.375	11	0.630	0.011	0.043	0.059			●		
16IR12W	Internal	Right	Regular	0.375	12	0.630	0.010	0.043	0.055			●		
16IR14W	Internal	Right	Regular	0.375	14	0.630	0.008	0.039	0.047			●		
16IR16W	Internal	Right	Regular	0.375	16	0.630	0.007	0.035	0.043					
16IR18W	Internal	Right	Regular	0.375	18	0.630	0.006	0.031	0.039			●		
16IR19W	Internal	Right	Regular	0.375	19	0.630	0.006	0.031	0.039					
16IR20W	Internal	Right	Regular	0.375	20	0.630	0.006	0.031	0.035			●		
16IR22W	Internal	Right	Regular	0.375	22	0.630	0.005	0.031	0.035					
16IR24W	Internal	Right	Regular	0.375	24	0.630	0.004	0.028	0.031			●		
16IR26W	Internal	Right	Regular	0.375	26	0.630	0.004	0.028	0.031			●		
16IR28W	Internal	Right	Regular	0.375	28	0.630	0.004	0.024	0.028					
16IR32W	Internal	Right	Regular	0.375	32	0.630	0.004	0.024	0.024					
16IR40W	Internal	Right	Regular	0.375	40	0.630	0.002	0.024	0.024					
16IR56W	Internal	Right	Regular	0.375	56	0.630	0.002	0.028	0.016					

● = P ● = M ● = K ● = N ● = S ○ = H

INTERNAL - RIGHT HAND, FULL PROFILE (BSW, BSF, BSP) BS.84-1956 DIN 259 MEDIUM CLASS

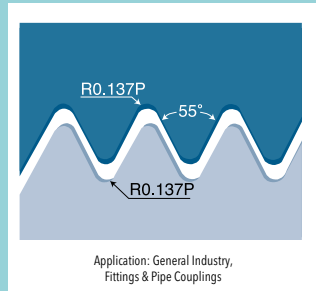
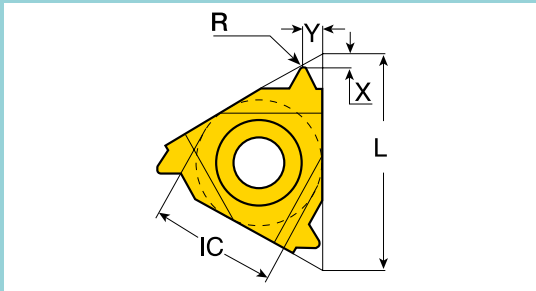
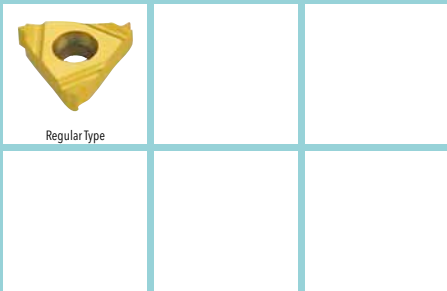

Designation	Thread Type	Hand	Insert Type	IC (inch)	TPI	L (inch)	R (inch)	X (inch)	Y (inch)	Grade		
										TT8010	TT9030	
22IR5W	Internal	Right	Regular	0.500	5	0.866	0.026	0.067	0.094			
22IR6W	Internal	Right	Regular	0.500	6	0.866	0.021	0.063	0.091			
22IR7W	Internal	Right	Regular	0.500	7	0.866	0.018	0.063	0.091			
27IR4W	Internal	Right	Regular	0.625	4	1.063	0.032	0.079	0.114			
27IR4.5W	Internal	Right	Regular	0.625	4.5	1.063	0.029	0.071	0.102			

● = P ● = M ● = K ● = N ● = S ○ = H

TOTHREAD WHITWORTH (M-TYPE)

INTERNAL - RIGHT HAND, PRESSED, FULL PROFILE (BSW, BSF, BSP) BS.84-1956 DIN 259 MEDIUM CLASS

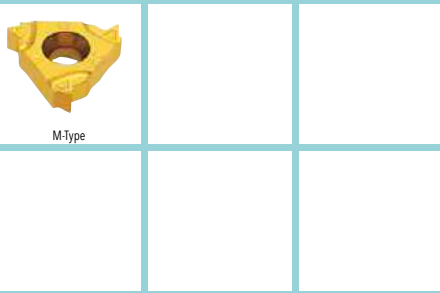

M-Type

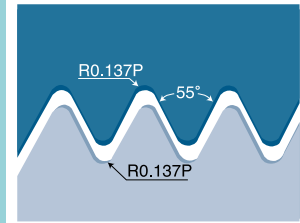
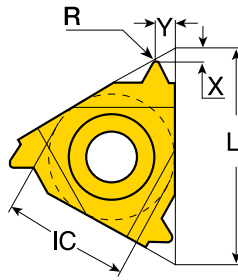

Application: General Industry, Fittings & Pipe Couplings

Designation	Thread Type	Hand	Insert Type	IC (inch)	TPI	L (inch)	R (inch)	X (inch)	Y (inch)	Grade	TT7010	TT9030
16IRM11W	Internal	Right	M-Type	0.375	11	0.630	0.012	0.043	0.059			
16IRM14W	Internal	Right	M-Type	0.375	14	0.630	0.009	0.039	0.047			
16IRM16W	Internal	Right	M-Type	0.375	16	0.630	0.008	0.035	0.043			
16IRM19W	Internal	Right	M-Type	0.375	19	0.630	0.003	0.031	0.039			

● = P ● = M ● = K ● = N ● = S ○ = H

TOTHREAD WHITWORTH (U-TYPE)

INTERNAL - FULL PROFILE (BSN, BSF, BSP) BS.84-1956 DIN 259 MEDIUM CLASS

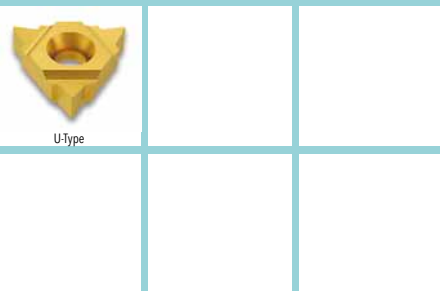

U-Type

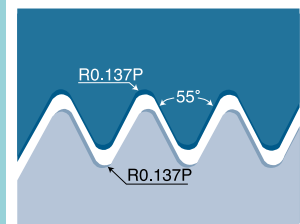
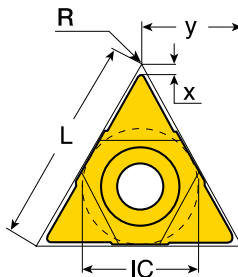

Application: General Industry, Fittings & Pipe Couplings

Designation	Thread Type	Hand	Insert Type	IC (inch)	TPI	L (inch)	R (inch)	X (inch)	Y (inch)	Grade	TT8010	TT9030
08UIRL11UN	Internal	Neutral	U-Type	0.188	11	0.315	0.011	0.035	0.157			
08UIRL12UN	Internal	Neutral	U-Type	0.188	12	0.315	0.005	0.035	0.157			
08UIRL13UN	Internal	Neutral	U-Type	0.188	13	0.315	0.004	0.039	0.157			
08UIRL14UN	Internal	Neutral	U-Type	0.188	14	0.315	0.008	0.039	0.157			

● = P ● = M ● = K ● = N ● = S ○ = H

INTERNAL AND EXTERNAL - FULL PROFILE (BSN, BSF, BSP) BS.84-1956 DIN 259 MEDIUM CLASS

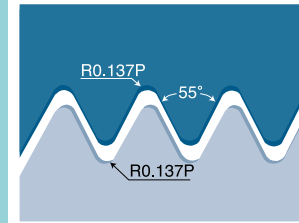
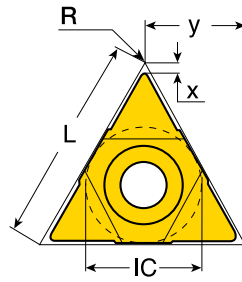

Application: General Industry,
Fittings & Pipe Couplings

Designation	Thread Type	Hand	Insert Type	IC (inch)	TPI	L (inch)	R (inch)	X (inch)	Y (inch)	Grade	TT7010	TT9030		
22UEIRL4W	Int / Ext	Neutral	U-Type	0.500	4	0.866	0.032	0.071	0.433					
22UEIRL4.5W	Int / Ext	Neutral	U-Type	0.500	4.5	0.866	0.029	0.091	0.439					
27UEIRL2.75W	Int / Ext	Neutral	U-Type	0.625	2.75	1.063	0.048	0.094	0.539					
27UEIRL3.00W	Int / Ext	Neutral	U-Type	0.625	3	1.063	0.044	0.091	0.539					
27UEIRL3.25W	Int / Ext	Neutral	U-Type	0.625	3.25	1.063	0.041	0.079	0.539					
27UEIRL3.50W	Int / Ext	Neutral	U-Type	0.625	3.5	1.063	0.037	0.083	0.539					

● = P ● = M ● = K ● = N ● = S ○ = H

TOTHREAD NPT (NATIONAL PIPE THREADS)

EXTERNAL - FULL PROFILE (ANSI/ASME B1.20.1-1983), REGULAR AND M-TYPE

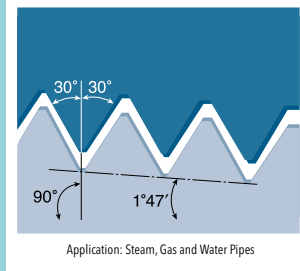
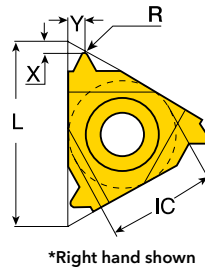

Designation	Thread Type	Hand	Insert Type	IC (inch)	TPI	L (inch)	R (inch)	X (inch)	Y (inch)	Grade	T17010	T19030		
16EL8NPT	External	Left	Regular	0.375	8	0.630	0.005	0.051	0.071					
16EL11.5NPT	External	Left	Regular	0.375	11.5	0.630	0.004	0.043	0.059					
16EL14NPT	External	Left	Regular	0.375	14	0.630	0.003	0.035	0.047					
16EL18NPT	External	Left	Regular	0.375	18	0.630	0.002	0.031	0.039					
16EL27NPT	External	Left	Regular	0.375	27	0.630	0.002	0.028	0.031					
16ER8NPT	External	Right	Regular	0.375	8	0.630	0.005	0.051	0.071					
16ERM8NPT	External	Right	M-Type	0.375	8	0.630	0.006	0.047	0.071					
16ER11.5NPT	External	Right	Regular	0.375	11.5	0.630	0.004	0.043	0.059					
16ERM11.5NPT	External	Right	M-Type	0.375	11.5	0.630	0.004	0.043	0.059					
16ER14NPT	External	Right	Regular	0.375	14	0.630	0.003	0.035	0.047					
16ERM14NPT	External	Right	M-Type	0.375	14	0.630	0.002	0.035	0.047					
16ER18NPT	External	Right	Regular	0.375	18	0.630	0.002	0.031	0.039					
16ERM18NPT	External	Right	M-Type	0.375	18	0.630	0.002	0.031	0.039					
16ER27NPT	External	Right	Regular	0.375	27	0.630	0.002	0.028	0.031					

● = P ● = M ● = K ● = N ● = S ○ = H

INTERNAL - FULL PROFILE (ANSI/ASME B1.20.1-1983), REGULAR AND M-TYPE

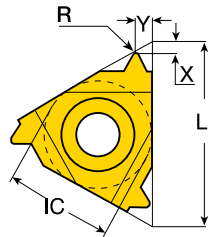
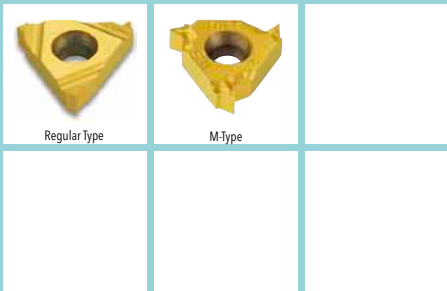

*Right hand shown

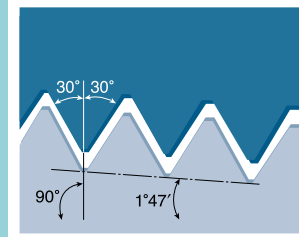

Application: Steam, Gas and Water Pipes

Designation	Thread Type	Hand	Insert Type	IC (inch)	TPI	L (inch)	R (inch)	X (inch)	Y (inch)	Grade	TT7010	TT8010	TT9030
16IL8NPT	Internal	Left	Regular	0.375	8	0.630	0.005	0.047	0.071				●
16IL11.5NPT	Internal	Left	Regular	0.375	11.5	0.630	0.004	0.043	0.059				
11IL14NPT	Internal	Left	Regular	0.250	14	0.433	0.002	0.031	0.039				
16IL14NPT	Internal	Left	Regular	0.375	14	0.630	0.003	0.035	0.047				●
11IL18NPT	Internal	Left	Regular	0.250	18	0.433	0.002	0.031	0.039				
16IL18NPT	Internal	Left	Regular	0.375	18	0.630	0.002	0.031	0.039				
06IL27NPT	Internal	Left	Regular	0.156	27	0.236	0.002	0.024	0.024				
08IL27NPT	Internal	Left	Regular	0.188	27	0.315	0.002	0.024	0.024				
11IL27NPT	Internal	Left	Regular	0.250	27	0.433	0.002	0.028	0.031				
16IL27NPT	Internal	Left	Regular	0.375	27	0.630	0.002	0.028	0.031				
16IR11.5NPT	Internal	Right	Regular	0.375	11.5	0.630	0.004	0.043	0.059				●
16IRM11.5NPT	Internal	Right	M-Type	0.375	11.5	0.630	0.004	0.043	0.059				●
11IR14NPT	Internal	Right	Regular	0.250	14	0.433	0.002	0.031	0.039	●			●
16IR14NPT	Internal	Right	Regular	0.375	14	0.630	0.003	0.035	0.047				●
16IRM14NPT	Internal	Right	M-Type	0.375	14	0.630	0.002	0.035	0.047	●			●
08IR18NPT	Internal	Right	Regular	0.188	18	0.315	0.002	0.024	0.024		●		●
11IR18NPT	Internal	Right	Regular	0.250	18	0.433	0.002	0.031	0.039				●
16IR18NPT	Internal	Right	Regular	0.375	18	0.630	0.002	0.031	0.039	●			●
06IR27NPT	Internal	Right	Regular	0.156	27	0.236	0.002	0.024	0.024		●		
08IR27NPT	Internal	Right	Regular	0.188	27	0.315	0.002	0.024	0.024		●		
16IR27NPT	Internal	Right	Regular	0.375	27	0.630	0.002	0.028	0.031				
16IR8NPT	Internal	Right	Regular	0.375	8	0.630	0.005	0.047	0.071				●
16IRM8NPT	Internal	Right	M-Type	0.375	8	0.630	0.006	0.047	0.071				●

● = P ● = M ● = K ● = N ● = S ○ = H

TOThread NPTF (NATIONAL PIPE THREAD - DRY SEAL)

EXTERNAL - FULL PROFILE (ANSI/ASME B1.20.3-1976)

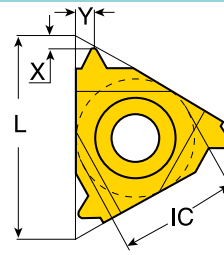

*Right hand shown

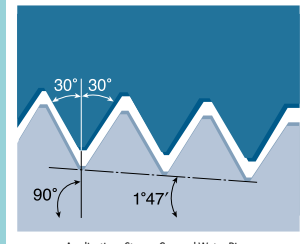

Designation	Thread Type	Hand	Insert Type	IC (inch)	TPI	L (inch)	X (inch)	Y (inch)	Grade	P30	T19030		
11EL14NPTF	External	Left	Regular	0.250	14	0.433	0.031	0.039					
11EL18NPTF	External	Left	Regular	0.250	18	0.433	0.031	0.039					
11EL27NPTF	External	Left	Regular	0.250	27	0.433	0.028	0.028					
16EL11.5NPTF	External	Left	Regular	0.375	11.5	0.630	0.043	0.059					
16EL14NPTF	External	Left	Regular	0.375	14	0.630	0.035	0.047					
16EL18NPTF	External	Left	Regular	0.375	18	0.630	0.031	0.039					
16EL27NPTF	External	Left	Regular	0.375	27	0.630	0.028	0.028					
16EL8NPTF	External	Left	Regular	0.375	8	0.630	0.051	0.071					
11ER14NPTF	External	Right	Regular	0.250	14	0.433	0.031	0.039					
11ER18NPTF	External	Right	Regular	0.250	18	0.433	0.031	0.039					
11ER27NPTF	External	Right	Regular	0.250	27	0.433	0.028	0.028					
16ER8NPTF	External	Right	Regular	0.375	8	0.630	0.051	0.071					
16ER11.5NPTF	External	Right	Regular	0.375	11.5	0.630	0.043	0.059					
16ER14NPTF	External	Right	Regular	0.375	14	0.630	0.035	0.047					
16ER18NPTF	External	Right	Regular	0.375	18	0.630	0.031	0.039					
16ER27NPTF	External	Right	Regular	0.375	27	0.630	0.028	0.028					

● = P ● = M ● = K ● = N ● = S ○ = H

INTERNAL - FULL PROFILE (ANSI/ASME B1.20.3-1976)

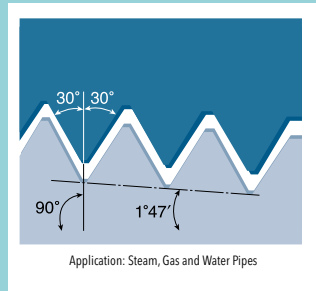
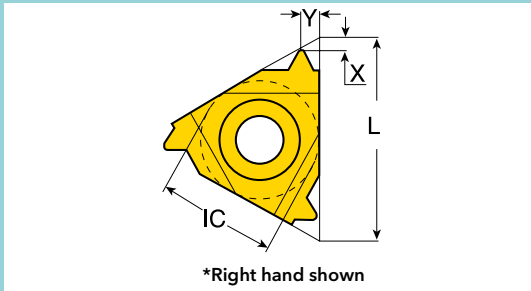
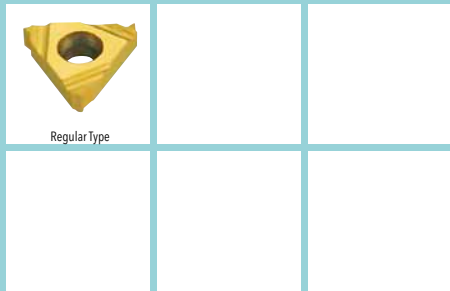

Designation	Thread Type	Hand	Insert Type	IC (inch)	TPI	L (inch)	X (inch)	Y (inch)	Grade	TT8010	TT9030		
06IL27NPTF	Internal	Left	Regular	0.156	27	0.236	0.028	0.024					
08IL18NPTF	Internal	Left	Regular	0.188	18	0.315	0.024	0.024					
08IL27NPTF	Internal	Left	Regular	0.188	27	0.315	0.024	0.024					
11IL14NPTF	Internal	Left	Regular	0.250	14	0.433	0.031	0.039					
11IL18NPTF	Internal	Left	Regular	0.250	18	0.433	0.031	0.039					
11IL27NPTF	Internal	Left	Regular	0.250	27	0.433	0.028	0.028					
16IL11.5NPTF	Internal	Left	Regular	0.375	11.5	0.630	0.043	0.059					
16IL8NPTF	Internal	Left	Regular	0.375	8	0.630	0.051	0.071					
16IL14NPTF	Internal	Left	Regular	0.375	14	0.630	0.035	0.047					
16IL18NPTF	Internal	Left	Regular	0.375	18	0.630	0.031	0.039					
16IL27NPTF	Internal	Left	Regular	0.375	27	0.630	0.028	0.028					
06IR27NPTF	Internal	Right	Regular	0.156	27	0.236	0.028	0.024					
08IR18NPTF	Internal	Right	Regular	0.188	18	0.315	0.024	0.024					
08IR27NPTF	Internal	Right	Regular	0.188	27	0.315	0.024	0.024					
11IR14NPTF	Internal	Right	Regular	0.250	14	0.433	0.031	0.039					
11IR18NPTF	Internal	Right	Regular	0.250	18	0.433	0.031	0.039					
11IR27NPTF	Internal	Right	Regular	0.250	27	0.433	0.028	0.028					
16IR8NPTF	Internal	Right	Regular	0.375	8	0.630	0.051	0.071					
16IR11.5NPTF	Internal	Right	Regular	0.375	11.5	0.630	0.043	0.059					
16IR14NPTF	Internal	Right	Regular	0.375	14	0.630	0.035	0.047					
16IR18NPTF	Internal	Right	Regular	0.375	18	0.630	0.031	0.039					
16IR27NPTF	Internal	Right	Regular	0.375	27	0.630	0.028	0.028					

● = P ● = M ● = K ● = N ● = S ○ = H



TOTHREAD BSPT (BRITISH STANDARD PIPE THREAD)

EXTERNAL - FULL PROFILE (B.S.21-1957)



Regular Type

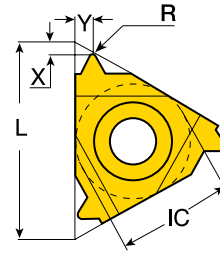

*Right hand shown

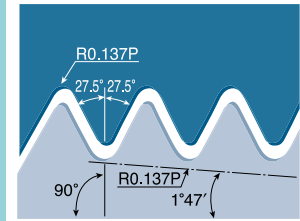

Application: Steam, Gas and Water Pipes

Designation	Thread Type	Hand	Insert Type	IC (inch)	TPI	L (inch)	R (inch)	X (inch)	Y (inch)	Grade	T77010	T9030		
16EL11BSPT	External	Left	Regular	0.375	11	0.630	0.011	0.043	0.059					
16EL14BSPT	External	Left	Regular	0.375	14	0.630	0.008	0.039	0.047					
16EL19BSPT	External	Left	Regular	0.375	19	0.630	0.006	0.031	0.035					
16EL28BSPT	External	Left	Regular	0.375	28	0.630	0.004	0.024	0.024					
16ER11BSPT	External	Right	Regular	0.375	11	0.630	0.011	0.043	0.059					
16ER14BSPT	External	Right	Regular	0.375	14	0.630	0.008	0.039	0.047					
16ER19BSPT	External	Right	Regular	0.375	19	0.630	0.006	0.031	0.035					
16ER28BSPT	External	Right	Regular	0.375	28	0.630	0.004	0.024	0.024					

● = P ● = M ● = K ● = N ● = S ○ = H

INTERNAL - FULL PROFILE (B.S.21-1957)

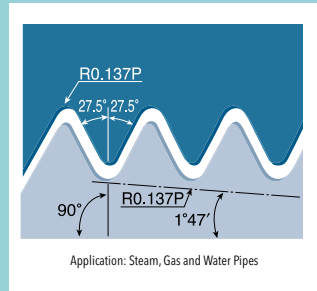
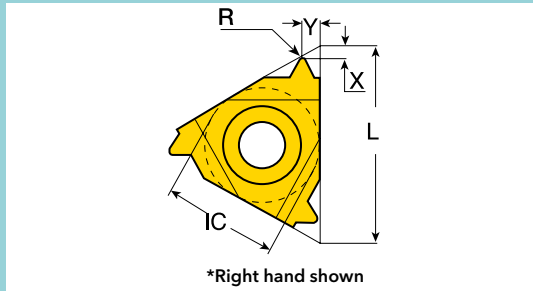
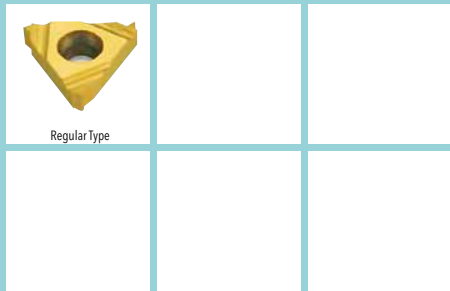

Designation	Thread Type	Hand	Insert Type	IC (inch)	TPI	L (inch)	R (inch)	X (inch)	Y (inch)	Grade	TT9030			
06IL27BSPT	Internal	Left	Regular	0.156	27	0.236	0.004	0.028	0.024					
11IL14BSPT	Internal	Left	Regular	0.250	14	0.433	0.008	0.035	0.039					
11IL19BSPT	Internal	Left	Regular	0.250	19	0.433	0.006	0.031	0.035					
11IL28BSPT	Internal	Left	Regular	0.250	28	0.433	0.004	0.024	0.024					
16IL11BSPT	Internal	Left	Regular	0.375	11	0.630	0.011	0.043	0.059					
16IL14BSPT	Internal	Left	Regular	0.375	14	0.630	0.008	0.039	0.047					
16IL19BSPT	Internal	Left	Regular	0.375	19	0.630	0.006	0.031	0.035					
16IL28BSPT	Internal	Left	Regular	0.375	28	0.630	0.004	0.024	0.024					
11IR19BSPT	Internal	Right	Regular	0.250	19	0.433	0.006	0.031	0.035					
11IR28BSPT	Internal	Right	Regular	0.250	28	0.433	0.004	0.024	0.024					
16IR11BSPT	Internal	Right	Regular	0.375	11	0.630	0.011	0.043	0.059					
16IR14BSPT	Internal	Right	Regular	0.375	14	0.630	0.008	0.039	0.047					

● = P ● = M ● = K ● = N ● = S ○ = H

TOTHREAD STUB ACME

EXTERNAL - (ASME/ANSI B1.5-1988 CLASS 2G)

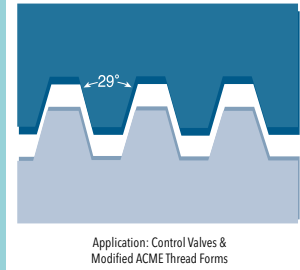
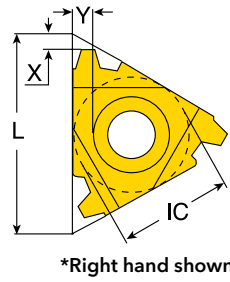
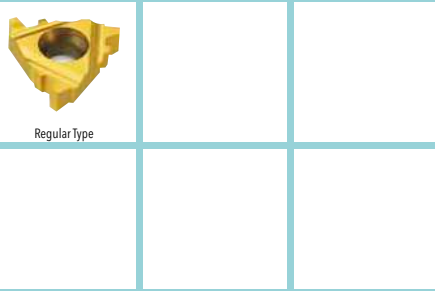

Designation	Thread Type	Hand	Insert Type	IC (inch)	TPI	L (inch)	X (inch)	Y (inch)	Grade	T17010	T19030	UF10
16EL6STACME	External	Left	Regular	0.375	6	0.630	0.067	0.071				
16EL10STACME	External	Left	Regular	0.375	10	0.630	0.047	0.051				
16EL12STACME	External	Left	Regular	0.375	12	0.630	0.047	0.047				
16EL14STACME	External	Left	Regular	0.375	14	0.630	0.043	0.043				
16EL16STACME	External	Left	Regular	0.375	16	0.630	0.039	0.039				
16EL8STACME	External	Left	Regular	0.375	8	0.630	0.055	0.059				
22EL5STACME	External	Left	Regular	0.500	5	0.866	0.083	0.091				
27EL3STACME	External	Left	Regular	0.625	3	1.063	0.114	0.114				
27EL4STACME	External	Left	Regular	0.625	4	1.063	0.091	0.095				
16ER6STACME	External	Right	Regular	0.375	6	0.630	0.067	0.071				
16ER8STACME	External	Right	Regular	0.375	8	0.630	0.055	0.059				
16ER10STACME	External	Right	Regular	0.375	10	0.630	0.047	0.510				
16ER12STACME	External	Right	Regular	0.375	12	0.630	0.047	0.047				
16ER14STACME	External	Right	Regular	0.375	14	0.630	0.043	0.043				
16ER16STACME	External	Right	Regular	0.375	16	0.630	0.039	0.039				
22ER5STACME	External	Right	Regular	0.500	5	0.866	0.083	0.091				
27ER3STACME	External	Right	Regular	0.625	3	1.063	0.114	0.114				
27ER4STACME	External	Right	Regular	0.625	4	1.063	0.091	0.095				

● = P ● = M ● = K ● = N ● = S ○ = H

INTERNAL - (ASME/ANSI B1.5-1988 CLASS 2G)

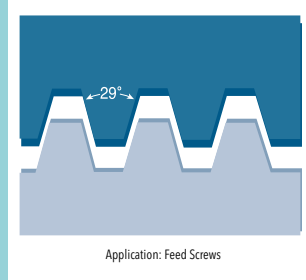
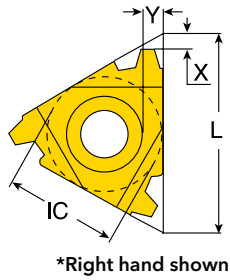
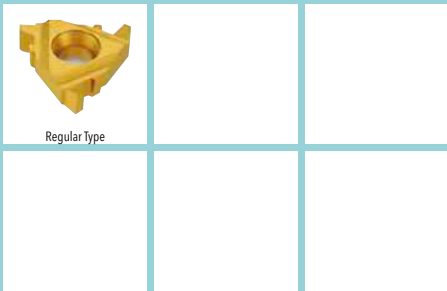

Designation	Thread Type	Hand	Insert Type	IC (inch)	TPI	L (inch)	X (inch)	Y (inch)	Grade	P30	TT7010	TT9030
16IL6STACME	Internal	Left	Regular	0.375	6	0.630	0.067	0.071				
16IL10STACME	Internal	Left	Regular	0.375	10	0.630	0.047	0.051				
16IL12STACME	Internal	Left	Regular	0.375	12	0.630	0.043	0.047				
16IL14STACME	Internal	Left	Regular	0.375	14	0.630	0.043	0.043				
16IL16STACME	Internal	Left	Regular	0.375	16	0.630	0.039	0.043				
16IL8STACME	Internal	Left	Regular	0.375	8	0.630	0.055	0.059				
22IL5STACME	Internal	Left	Regular	0.500	5	0.866	0.083	0.091				
27IL3STACME	Internal	Left	Regular	0.625	3	1.063	0.114	0.114			●	
27IL4STACME	Internal	Left	Regular	0.625	4	1.063	0.091	0.095				
16IR6STACME	Internal	Right	Regular	0.375	6	0.630	0.067	0.071			●	
16IR8STACME	Internal	Right	Regular	0.375	8	0.630	0.055	0.059				●
16IR10STACME	Internal	Right	Regular	0.375	10	0.630	0.047	0.051				●
16IR12STACME	Internal	Right	Regular	0.375	12	0.630	0.043	0.047		●		●
16IR14STACME	Internal	Right	Regular	0.375	14	0.630	0.043	0.043				
16IR16STACME	Internal	Right	Regular	0.375	16	0.630	0.039	0.043		●		
22IR5STACME	Internal	Right	Regular	0.500	5	0.866	0.083	0.091			●	●
27IR3STACME	Internal	Right	Regular	0.625	3	1.063	0.114	0.114			●	
27IR4STACME	Internal	Right	Regular	0.625	4	1.063	0.091	0.095				

● = P ● = M ● = K ● = N ● = S ○ = H

EXTERNAL - (ASME/ANSI B1.5-1988 CLASS 3G)

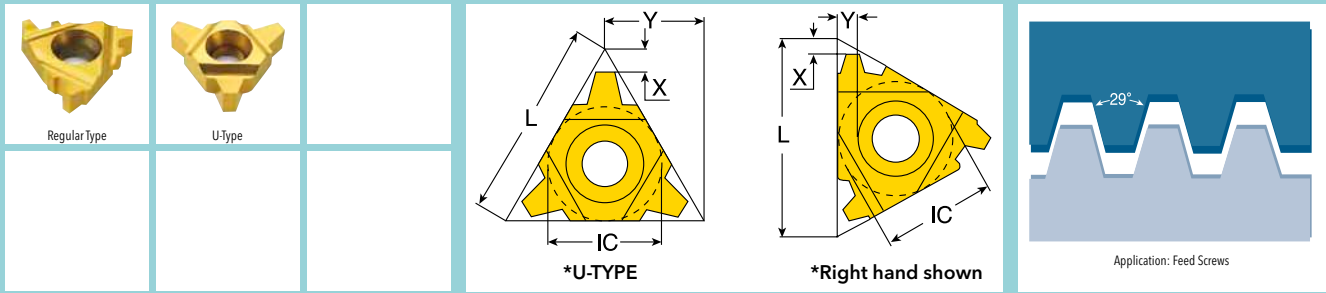

Designation	Thread Type	Hand	Insert Type	IC (inch)	TPI	L (inch)	X (inch)	Y (inch)	Grade	P30	TT7010	TT9030
16EL8ACME	External	Left	Regular	0.375	8	0.630	0.055	0.059				●
16EL10ACME	External	Left	Regular	0.375	10	0.630	0.051	0.051				
16EL12ACME	External	Left	Regular	0.375	12	0.630	0.043	0.047				
16EL14ACME	External	Left	Regular	0.375	14	0.630	0.039	0.047				
16EL16ACME	External	Left	Regular	0.375	16	0.630	0.039	0.043				
22EL5ACME	External	Left	Regular	0.500	5	0.866	0.079	0.091				●
22EL6ACME	External	Left	Regular	0.500	6	0.866	0.071	0.083				●
27EL4ACME	External	Left	Regular	0.625	4	1.063	0.094	0.106				●
27UERL3ACME	External	Neutral	U-Type	0.625	3	1.063	0.118	0.539				●
16ER8ACME	External	Right	Regular	0.375	8	0.630	0.055	0.059			●	●
16ER10ACME	External	Right	Regular	0.375	10	0.630	0.051	0.051		●	●	●
16ER12ACME	External	Right	Regular	0.375	12	0.630	0.043	0.047				●
16ER14ACME	External	Right	Regular	0.375	14	0.630	0.039	0.047				
16ER16ACME	External	Right	Regular	0.375	16	0.630	0.039	0.043				●
22ER5ACME	External	Right	Regular	0.500	5	0.866	0.079	0.091			●	●
22ER6ACME	External	Right	Regular	0.500	6	0.866	0.071	0.083			●	●
27ER4ACME	External	Right	Regular	0.625	4	1.063	0.094	0.106		●	●	●

● = P ● = M ● = K ● = N ● = S ○ = H

INTERNAL - (ASME/ANSI B1.5-1988 CLASS 3G)

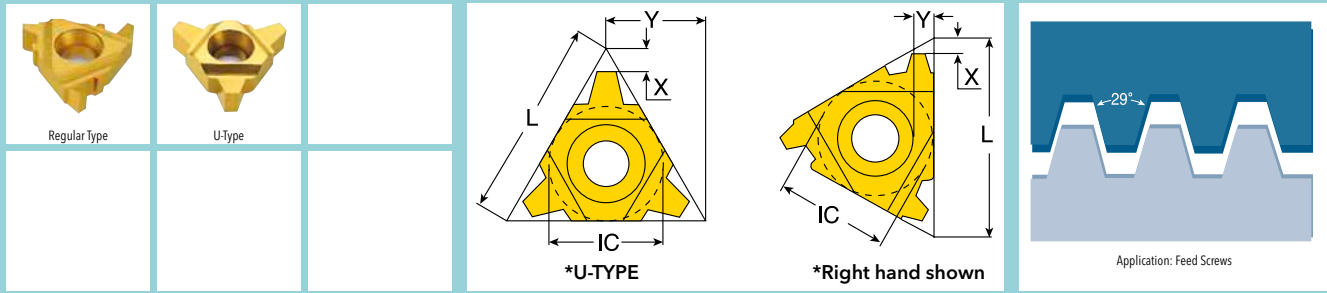

Designation	Thread Type	Hand	Insert Type	IC (inch)	TPI	L (inch)	X (inch)	Y (inch)	Grade	P30	T77010	T79030
16IL8ACME	Internal	Left	Regular	0.375	8	0.630	0.055	0.059				●
16IL10ACME	Internal	Left	Regular	0.375	10	0.630	0.047	0.051				●
16IL12ACME	Internal	Left	Regular	0.375	12	0.630	0.047	0.047				
16IL14ACME	Internal	Left	Regular	0.375	14	0.630	0.043	0.047				
16IL16ACME	Internal	Left	Regular	0.375	16	0.630	0.039	0.043				
22IL5ACME	Internal	Left	Regular	0.500	5	0.866	0.079	0.091				●
22IL6ACME	Internal	Left	Regular	0.500	6	0.866	0.071	0.083	●			●
27IL4ACME	Internal	Left	Regular	0.625	4	1.063	0.091	0.106				●
27UIRL3ACME	Internal	Neutral	U-Type	0.625	3	1.063	0.114	0.539				●
16IR8ACME	Internal	Right	Regular	0.375	8	0.630	0.055	0.059	●	●		●
16IR10ACME	Internal	Right	Regular	0.375	10	0.630	0.047	0.051		●		
16IR12ACME	Internal	Right	Regular	0.375	12	0.630	0.047	0.047				●
16IR14ACME	Internal	Right	Regular	0.375	14	0.630	0.043	0.047				
16IR16ACME	Internal	Right	Regular	0.375	16	0.630	0.039	0.043				
22IR5ACME	Internal	Right	Regular	0.500	5	0.866	0.079	0.091				●
22IR6ACME	Internal	Right	Regular	0.500	6	0.866	0.071	0.083	●			●
27IR4ACME	Internal	Right	Regular	0.625	4	1.063	0.091	0.106	●	●		●

● = P ● = M ● = K ● = N ● = S ○ = H

EXTERNAL - LEFT HAND, FULL PROFILE (S-8879C 9-1992 CLASS 3A)

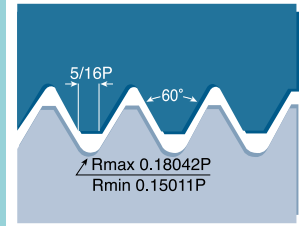
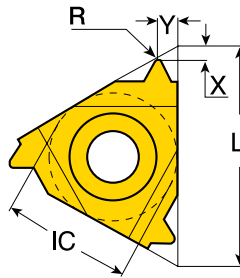
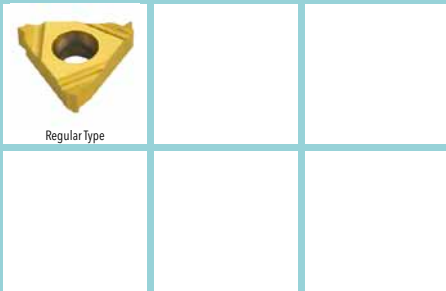

Application: Aircraft & Aerospace

Designation	Thread Type	Hand	Insert Type	IC (inch)	TPI	L (inch)	R (inch)	X (inch)	Y (inch)	Grade	TT9030			
11EL14UNJ	External	Left	Regular	0.250	14	0.433	0.011	0.039	0.047					
11EL16UNJ	External	Left	Regular	0.250	16	0.433	0.010	0.035	0.043					
11EL18UNJ	External	Left	Regular	0.250	18	0.433	0.009	0.031	0.039					
11EL20UNJ	External	Left	Regular	0.250	20	0.433	0.008	0.031	0.035					
11EL24UNJ	External	Left	Regular	0.250	24	0.433	0.007	0.028	0.031					
11EL28UNJ	External	Left	Regular	0.250	28	0.433	0.006	0.028	0.028					
11EL32UNJ	External	Left	Regular	0.250	32	0.433	0.005	0.024	0.028					
11EL36UNJ	External	Left	Regular	0.250	36	0.433	0.004	0.024	0.024					
11EL40UNJ	External	Left	Regular	0.250	40	0.433	0.004	0.024	0.024					
11EL44UNJ	External	Left	Regular	0.250	44	0.433	0.004	0.024	0.024					
11EL48UNJ	External	Left	Regular	0.250	48	0.433	0.003	0.024	0.020					
16EL8UNJ	External	Left	Regular	0.375	8	0.630	0.020	0.047	0.063					
16EL9UNJ	External	Left	Regular	0.375	9	0.630	0.017	0.051	0.067					
16EL10UNJ	External	Left	Regular	0.375	10	0.630	0.016	0.047	0.059					
16EL11UNJ	External	Left	Regular	0.375	11	0.630	0.014	0.047	0.059					
16EL12UNJ	External	Left	Regular	0.375	12	0.630	0.013	0.043	0.051					
16EL13UNJ	External	Left	Regular	0.375	13	0.630	0.012	0.039	0.051					
16EL14UNJ	External	Left	Regular	0.375	14	0.630	0.011	0.039	0.047					
16EL16UNJ	External	Left	Regular	0.375	16	0.630	0.010	0.035	0.043					
16EL18UNJ	External	Left	Regular	0.375	18	0.630	0.009	0.031	0.039					
16EL20UNJ	External	Left	Regular	0.375	20	0.630	0.008	0.031	0.035					
16EL24UNJ	External	Left	Regular	0.375	24	0.630	0.007	0.028	0.031					
16EL28UNJ	External	Left	Regular	0.375	28	0.630	0.006	0.028	0.028					
16EL32UNJ	External	Left	Regular	0.375	32	0.630	0.005	0.024	0.028					
16EL36UNJ	External	Left	Regular	0.375	36	0.630	0.004	0.024	0.024					
16EL40UNJ	External	Left	Regular	0.375	40	0.630	0.004	0.024	0.024					
16EL44UNJ	External	Left	Regular	0.375	44	0.630	0.004	0.024	0.024					
16EL48UNJ	External	Left	Regular	0.375	48	0.630	0.003	0.024	0.020					
22EL5UNJ	External	Left	Regular	0.500	5	0.866	-	0.071	0.098					
22EL6UNJ	External	Left	Regular	0.500	6	0.866	-	0.067	0.091					
22EL7UNJ	External	Left	Regular	0.500	7	0.866	-	0.067	0.091					
27EL4UNJ	External	Left	Regular	0.625	4	1.063	-	0.087	0.118					
27EL4.5UNJ	External	Left	Regular	0.625	4.5	1.063	-	0.079	0.106					

● = P ● = M ● = K ● = N ● = S ○ = H

EXTERNAL - RIGHT HAND, FULL PROFILE (S-8879C 9-1992 CLASS 3A)

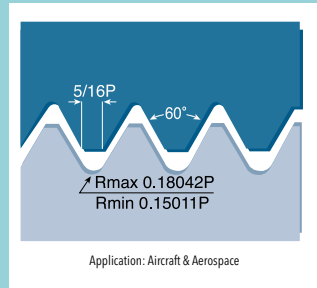
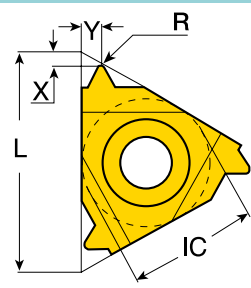
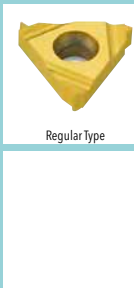

Designation	Thread Type	Hand	Insert Type	IC (inch)	TPI	L (inch)	R (inch)	X (inch)	Y (inch)	Grade	TT9030			
11ER14UNJ	External	Right	Regular	0.250	14	0.433	0.011	0.039	0.047					
11ER16UNJ	External	Right	Regular	0.250	16	0.433	0.010	0.035	0.043					
11ER18UNJ	External	Right	Regular	0.250	18	0.433	0.009	0.031	0.039					
11ER20UNJ	External	Right	Regular	0.250	20	0.433	0.008	0.031	0.035					
11ER24UNJ	External	Right	Regular	0.250	24	0.433	0.007	0.028	0.031					
11ER28UNJ	External	Right	Regular	0.250	28	0.433	0.006	0.028	0.028					
11ER32UNJ	External	Right	Regular	0.250	32	0.433	0.005	0.024	0.028					
11ER36UNJ	External	Right	Regular	0.250	36	0.433	0.004	0.024	0.024					
11ER40UNJ	External	Right	Regular	0.250	40	0.433	0.004	0.024	0.024					
11ER44UNJ	External	Right	Regular	0.250	44	0.433	0.004	0.024	0.024					
11ER48UNJ	External	Right	Regular	0.250	48	0.433	0.003	0.024	0.020					
16ER8UNJ	External	Right	Regular	0.375	8	0.630	0.020	0.047	0.063					
16ER9UNJ	External	Right	Regular	0.375	9	0.630	0.017	0.051	0.067					
16ER10UNJ	External	Right	Regular	0.375	10	0.630	0.016	0.047	0.059					
16ER11UNJ	External	Right	Regular	0.375	11	0.630	0.014	0.047	0.059					
16ER12UNJ	External	Right	Regular	0.375	12	0.630	0.013	0.043	0.051					
16ER13UNJ	External	Right	Regular	0.375	13	0.630	0.012	0.039	0.051					
16ER14UNJ	External	Right	Regular	0.375	14	0.630	0.011	0.039	0.047					
16ER16UNJ	External	Right	Regular	0.375	16	0.630	0.010	0.035	0.043					
16ER18UNJ	External	Right	Regular	0.375	18	0.630	0.009	0.031	0.039					
16ER20UNJ	External	Right	Regular	0.375	20	0.630	0.008	0.031	0.035					
16ER24UNJ	External	Right	Regular	0.375	24	0.630	0.007	0.028	0.031					
16ER28UNJ	External	Right	Regular	0.375	28	0.630	0.006	0.028	0.028					
16ER32UNJ	External	Right	Regular	0.375	32	0.630	0.005	0.024	0.028					
16ER36UNJ	External	Right	Regular	0.375	36	0.630	0.004	0.024	0.024					
16ER40UNJ	External	Right	Regular	0.375	40	0.630	0.004	0.024	0.024					
16ER44UNJ	External	Right	Regular	0.375	44	0.630	0.004	0.024	0.024					
16ER48UNJ	External	Right	Regular	0.375	48	0.630	0.003	0.024	0.020					
22ER5UNJ	External	Right	Regular	0.500	5	0.866	-	0.071	0.098					
22ER6UNJ	External	Right	Regular	0.500	6	0.866	-	0.067	0.091					
22ER7UNJ	External	Right	Regular	0.500	7	0.866	-	0.067	0.091					
27ER4UNJ	External	Right	Regular	0.625	4	1.063	-	0.087	0.118					
27ER4.5UNJ	External	Right	Regular	0.625	4.5	1.063	-	0.079	0.106					

● = P ● = M ● = K ● = N ● = S ○ = H

INTERNAL - RIGHT HAND, FULL PROFILE (S-8879C 9-1992 CLASS 3A)

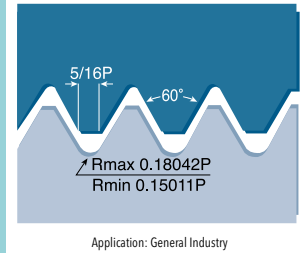
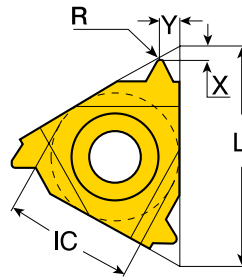

Designation	Thread Type	Hand	Insert Type	IC (inch)	TPI	L (inch)	R (inch)	X (inch)	Y (inch)	Grade	TT9030			
111R14UNJ	Internal	Right	Regular	0.250	14	0.433	0.011	0.039	0.047					
111R16UNJ	Internal	Right	Regular	0.250	16	0.433	0.010	0.035	0.043					
111R18UNJ	Internal	Right	Regular	0.250	18	0.433	0.009	0.031	0.039					
111R20UNJ	Internal	Right	Regular	0.250	20	0.433	0.008	0.031	0.035					
111R24UNJ	Internal	Right	Regular	0.250	24	0.433	0.007	0.028	0.031					
111R28UNJ	Internal	Right	Regular	0.250	28	0.433	0.006	0.028	0.028					
111R32UNJ	Internal	Right	Regular	0.250	32	0.433	0.005	0.024	0.028					
111R36UNJ	Internal	Right	Regular	0.250	36	0.433	0.004	0.024	0.024					
111R40UNJ	Internal	Right	Regular	0.250	40	0.433	0.004	0.024	0.024					
111R44UNJ	Internal	Right	Regular	0.250	44	0.433	0.004	0.024	0.020					
111R48UNJ	Internal	Right	Regular	0.250	48	0.433	0.003	0.024	0.020					
161R8UNJ	Internal	Right	Regular	0.375	8	0.630	0.020	0.047	0.063					
161R9UNJ	Internal	Right	Regular	0.375	9	0.630	0.017	0.051	0.067					
161R10UNJ	Internal	Right	Regular	0.375	10	0.630	0.016	0.047	0.059					
161R11UNJ	Internal	Right	Regular	0.375	11	0.630	0.014	0.047	0.059					
161R12UNJ	Internal	Right	Regular	0.375	12	0.630	0.013	0.043	0.051					
161R13UNJ	Internal	Right	Regular	0.375	13	0.630	0.012	0.039	0.051					
161R14UNJ	Internal	Right	Regular	0.375	14	0.630	0.011	0.039	0.047					
161R18UNJ	Internal	Right	Regular	0.375	18	0.630	0.009	0.031	0.039					
161R20UNJ	Internal	Right	Regular	0.375	20	0.630	0.008	0.031	0.035					
161R24UNJ	Internal	Right	Regular	0.375	24	0.630	0.007	0.028	0.031					
161R28UNJ	Internal	Right	Regular	0.375	28	0.630	0.006	0.028	0.028					
161R32UNJ	Internal	Right	Regular	0.375	32	0.630	0.005	0.024	0.028					
161R36UNJ	Internal	Right	Regular	0.375	36	0.630	0.004	0.024	0.024					
161R40UNJ	Internal	Right	Regular	0.375	40	0.630	0.004	0.024	0.024					
161R44UNJ	Internal	Right	Regular	0.375	44	0.630	0.004	0.024	0.024					
161R48UNJ	Internal	Right	Regular	0.375	48	0.630	0.003	0.024	0.020					
221R4UNJ	Internal	Right	Regular	0.500	4	0.866	-	0.087	0.118					
221R4.5UNJ	Internal	Right	Regular	0.500	4.5	0.866	-	0.078	0.106					
221R5UNJ	Internal	Right	Regular	0.500	5	0.866	-	0.071	0.098					
221R7UNJ	Internal	Right	Regular	0.500	7	0.866	-	0.067	0.091					

● = P ● = M ● = K ● = N ● = S ○ = H

EXTERNAL & INTERNAL - (DIN 103 04/1977 CLASS 7H (EXTERNAL) CLASS 7E (INTERNAL))

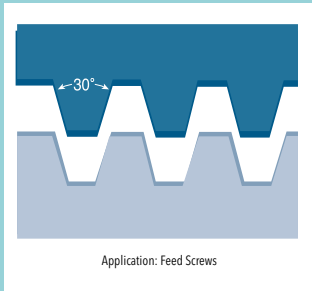
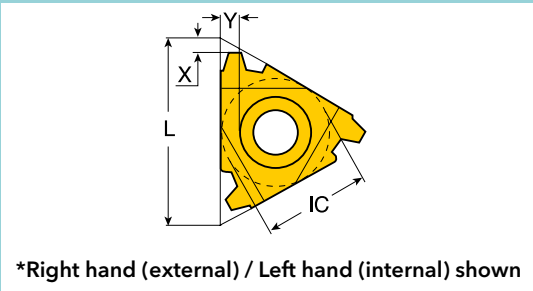
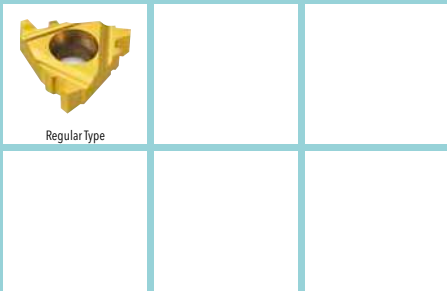

Designation	Thread Type	Hand	Insert Type	IC (inch)	Pitch (mm)	L (inch)	X (inch)	Y (inch)	Grade	TT7010	TT8010	TT9030
16EL1.5TR	External	Left	Regular	0.375	1.50	0.630	0.039	0.043				
16EL2TR	External	Left	Regular	0.375	2.00	0.630	0.043	0.051	●			
16EL3TR	External	Left	Regular	0.375	3.00	0.630	0.051	0.059				●
22EL4TR	External	Left	Regular	0.500	4.00	0.866	0.067	0.075				●
22EL5TR	External	Left	Regular	0.500	5.00	0.866	0.083	0.098				●
27EL6TR	External	Left	Regular	0.625	6.00	1.063	0.091	0.106				●
27EL7TR	External	Left	Regular	0.625	7.00	1.063	0.087	0.102				●
16ER1.5TR	External	Right	Regular	0.375	1.50	0.630	0.039	0.043				●
16ER2TR	External	Right	Regular	0.375	2.00	0.630	0.043	0.051				●
16ER3TR	External	Right	Regular	0.375	3.00	0.630	0.051	0.059				●
22ER4TR	External	Right	Regular	0.500	4.00	0.866	0.067	0.075				●
22ER5TR	External	Right	Regular	0.500	5.00	0.866	0.083	0.098				●
27ER6TR	External	Right	Regular	0.625	6.00	1.063	0.091	0.106				●
27ER7TR	External	Right	Regular	0.625	7.00	1.063	0.087	0.102	●			●
16IL3TR	Internal	Left	Regular	0.375	3.00	0.630	0.051	0.059				●
27IL6TR	Internal	Left	Regular	0.625	6.00	1.063	0.091	0.106				●
08IR1.5TR	Internal	Right	Regular	0.188	1.50	1.500	0.024	0.024		●		●
16IR2TR	Internal	Right	Regular	0.188	2.00	0.630	0.043	0.051				●
16IR3TR	Internal	Right	Regular	0.375	3.00	0.630	0.051	0.059				●
22IR4TR	Internal	Right	Regular	0.500	4.00	0.866	0.067	0.075				●
22IR5TR	Internal	Right	Regular	0.500	5.00	0.866	0.083	0.098	●			●
27IR6TR	Internal	Right	Regular	0.625	6.00	1.063	0.091	0.106	●			●

● = P ● = M ● = K ● = N ● = S ○ = H

TOTHREAD TRAPEZE DIN 103 (U-TYPE)

EXTERNAL & INTERNAL - (DIN 103 04/1977 CLASS 7H (EXTERNAL) CLASS 7E (INTERNAL))



U-Type

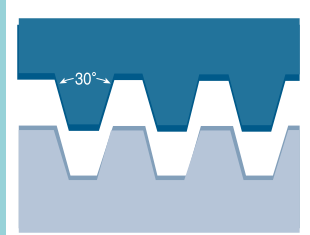
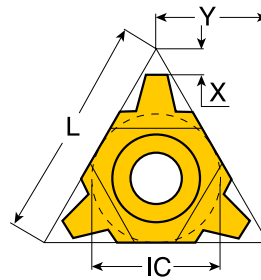

Application: Feed Screws

Designation	Thread Type	Hand	Insert Type	IC (inch)	Pitch (mm)	L (inch)	X (inch)	Y (inch)	Grade	T17010	T19030		
22UERL6TR	External	Neutral	U-Type	0.500	6.00	0.866	0.079	0.433					
22UERL7TR	External	Neutral	U-Type	0.500	7.00	0.866	0.091	0.433					
27UERL8TR	External	Neutral	U-Type	0.625	8.00	1.063	0.102	0.539					
27UERL9TR	External	Neutral	U-Type	0.625	9.00	1.063	0.118	0.539					
08UIRL2TR	Internal	Neutral	U-Type	0.188	2.00	0.315	0.035	0.157					
22UIRL6TR	Internal	Neutral	U-Type	0.500	6.00	0.866	0.079	0.433					
22UIRL7TR	Internal	Neutral	U-Type	0.500	7.00	0.866	0.091	0.433					
27UIRL8TR	Internal	Neutral	U-Type	0.625	8.00	1.063	0.102	0.539					
27UIRL9TR	Internal	Neutral	U-Type	0.625	9.00	1.063	0.118	0.539					

● = P ● = M ● = K ● = N ● = S ○ = H

EXTERNAL & INTERNAL - SAGENGENWINDE, (DIN 513 04-1985)

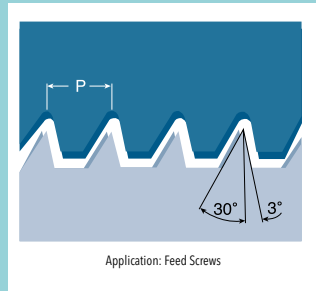
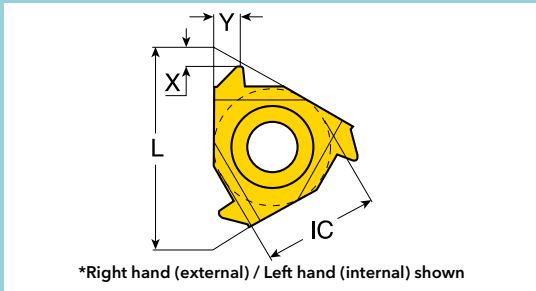
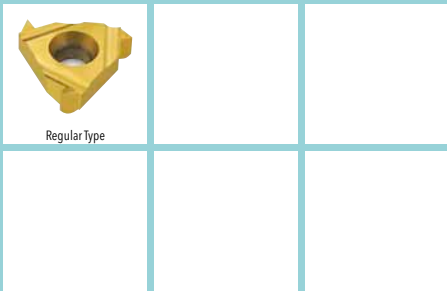

Designation	Thread Type	Hand	Insert Type	IC (inch)	Pitch (mm)	L (inch)	X (inch)	Y (inch)	Grade
16EL2SAGE	External	Left	Regular	0.375	2.00	0.630	0.043	0.063	TT9030
22EL3SAGE	External	Left	Regular	0.500	3.00	0.866	0.059	0.094	
22EL4SAGE	External	Left	Regular	0.500	4.00	0.866	0.075	0.122	
16ER2SAGE	External	Right	Regular	0.375	2.00	0.630	0.043	0.063	
22ER3SAGE	External	Right	Regular	0.500	3.00	0.866	0.059	0.094	
22ER4SAGE	External	Right	Regular	0.500	4.00	0.866	0.075	0.122	
16IL2SAGE	Internal	Left	Regular	0.375	2.00	0.630	0.047	0.067	
22IL3SAGE	Internal	Left	Regular	0.500	3.00	0.866	0.075	0.114	
22IL4SAGE	Internal	Left	Regular	0.500	4.00	0.866	0.091	0.138	
16IR2SAGE	Internal	Right	Regular	0.375	2.00	0.630	0.047	0.067	
22IR3SAGE	Internal	Right	Regular	0.500	3.00	0.866	0.075	0.114	
22IR4SAGE	Internal	Right	Regular	0.500	4.00	0.866	0.091	0.138	

● = P ● = M ● = K ● = N ● = S ○ = H



TOTHREAD SAGE DIN 513 (U-TYPE)

EXTERNAL & INTERNAL - SAGENGENWINDE (DIN 513 04-1985)

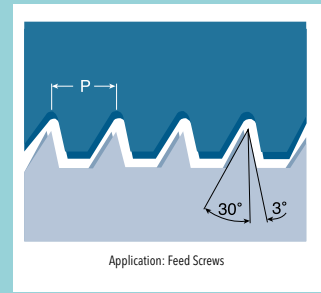
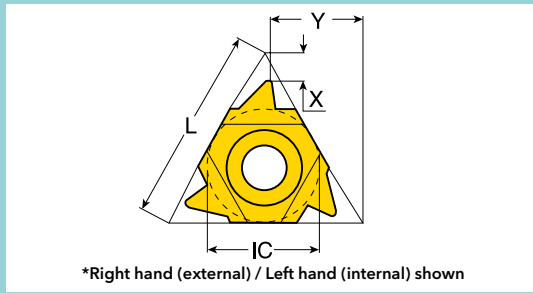
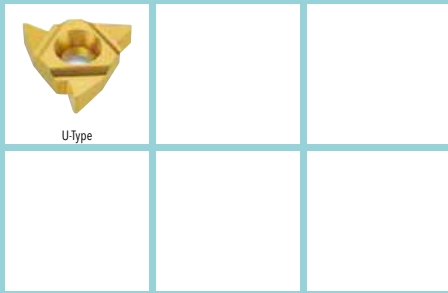

Designation	Thread Type	Hand	Insert Type	IC (inch)	Pitch (mm)	L (inch)	X (inch)	Y (inch)	Grade				
22UEL5SAGE	External	Left	U-Type	0.500	5.00	0.866	0.047	0.457					
22UEL6SAGE	External	Left	U-Type	0.500	6.00	0.866	0.047	0.461					
22UER5SAGE	External	Right	U-Type	0.500	5.00	0.866	0.047	0.457					
22UER6SAGE	External	Right	U-Type	0.500	6.00	0.866	0.047	0.461					
22UIL5SAGE	Internal	Left	U-Type	0.500	5.00	0.866	0.075	0.461					
22UIL6SAGE	Internal	Left	U-Type	0.500	6.00	0.866	0.083	0.469					
22UIR5SAGE	Internal	Right	U-Type	0.500	5.00	0.866	0.075	0.461					
22UIR6SAGE	Internal	Right	U-Type	0.500	6.00	0.866	0.083	0.469					

● = P ● = M ● = K ● = N ● = S ○ = H

EXTERNAL & INTERNAL - (ANSI B1.9-1973 CLASS 2)

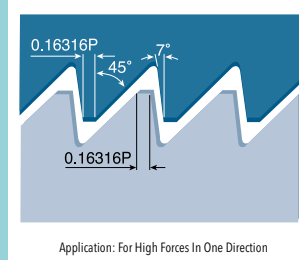
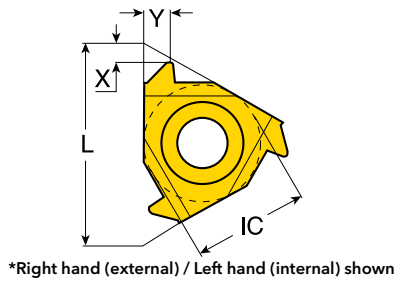

Designation	Thread Type	Hand	Insert Type	IC (inch)	TPI	L (inch)	X (inch)	Y (inch)	Grade	TT7010	TT9030		
11EL16ABUT	External	Left	Regular	0.250	16	0.433	0.051	0.075					
11EL20ABUT	External	Left	Regular	0.250	20	0.433	0.039	0.055					
16EL10ABUT	External	Left	Regular	0.375	10	0.630	0.059	0.091					
16EL12ABUT	External	Left	Regular	0.375	12	0.630	0.055	0.079					●
16EL16ABUT	External	Left	Regular	0.375	16	0.630	0.051	0.075					
16EL20ABUT	External	Left	Regular	0.375	20	0.630	0.039	0.055					
22EL6ABUT	External	Left	Regular	0.500	6	0.866	0.087	0.138					
22EL8ABUT	External	Left	Regular	0.500	8	0.866	0.087	0.138					
11ER16ABUT	External	Right	Regular	0.250	16	0.433	0.051	0.075					
11ER20ABUT	External	Right	Regular	0.250	20	0.433	0.039	0.055					
16ER10ABUT	External	Right	Regular	0.375	10	0.630	0.059	0.091					●
16ER12ABUT	External	Right	Regular	0.375	12	0.630	0.055	0.079					●
16ER16ABUT	External	Right	Regular	0.375	16	0.630	0.051	0.075					●
16ER20ABUT	External	Right	Regular	0.375	20	0.630	0.039	0.055					
22ER6ABUT	External	Right	Regular	0.500	6	0.866	0.087	0.138					●
22ER8ABUT	External	Right	Regular	0.500	8	0.866	0.079	0.126		●			
11IL16ABUT	Internal	Left	Regular	0.250	16	0.433	0.051	0.075					
11IL20ABUT	Internal	Left	Regular	0.250	20	0.433	0.039	0.055					
16IL10ABUT	Internal	Left	Regular	0.375	10	0.630	0.059	0.091					
16IL12ABUT	Internal	Left	Regular	0.375	12	0.630	0.055	0.079					
16IL16ABUT	Internal	Left	Regular	0.375	16	0.630	0.051	0.075					
16IL20ABUT	Internal	Left	Regular	0.375	20	0.630	0.039	0.055					
22IL6ABUT	Internal	Left	Regular	0.500	6	0.866	0.087	0.138					
22IL8ABUT	Internal	Left	Regular	0.500	8	0.866	0.079	0.126					
11IR16ABUT	Internal	Right	Regular	0.250	16	0.433	0.051	0.075					
11IR20ABUT	Internal	Right	Regular	0.250	20	0.433	0.039	0.055					
16IR10ABUT	Internal	Right	Regular	0.375	10	0.630	0.059	0.091					●
16IR12ABUT	Internal	Right	Regular	0.375	12	0.630	0.055	0.079					●
16IR16ABUT	Internal	Right	Regular	0.375	16	0.630	0.051	0.075					●
16IR20ABUT	Internal	Right	Regular	0.375	20	0.630	0.039	0.055					●
22IR6ABUT	Internal	Right	Regular	0.500	6	0.866	0.087	0.138					
22IR8ABUT	Internal	Right	Regular	0.500	8	0.866	0.079	0.126					●

● = P ● = M ● = K ● = N ● = S ○ = H

TOTHREAD AMERICAN BUTTRESS (U-TYPE)

EXTERNAL & INTERNAL - (ANSI B1.9-1973 CLASS 2)

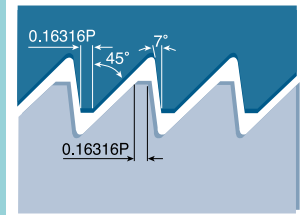
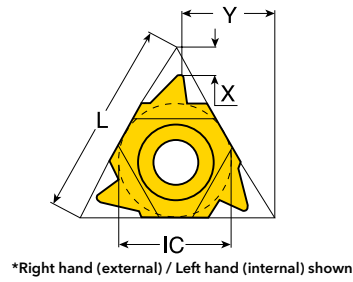
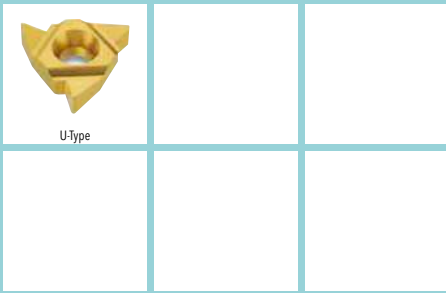

Application: For High Forces In One Direction

Designation	Thread Type	Hand	Insert Type	IC (inch)	TPI	L (inch)	X (inch)	Y (inch)	Grade	T7010	T9030
22UEL4ABUT	External	Left	U-Type	0.500	4	0.866	0.094	0.386			
22UER4ABUT	External	Right	U-Type	0.500	4	0.866	0.094	0.386			●
27UEL3ABUT	External	Left	U-Type	0.625	3	1.063	0.122	0.476			
27UER3ABUT	External	Right	U-Type	0.625	3	1.063	0.122	0.476			
22UIL4ABUT	Internal	Left	U-Type	0.500	4	0.866	0.094	0.386			
22UIR4ABUT	Internal	Right	U-Type	0.500	4	0.866	0.094	0.386	●		●
27UIL3ABUT	Internal	Left	U-Type	0.625	3	1.063	0.122	0.476			●
27UIR3ABUT	Internal	Right	U-Type	0.625	3	1.063	0.122	0.476			●

● = P ● = M ● = K ● = N ● = S ○ = H

EXTERNAL & INTERNAL - API ROUND TYPE (API SPEC 5B8-1996)

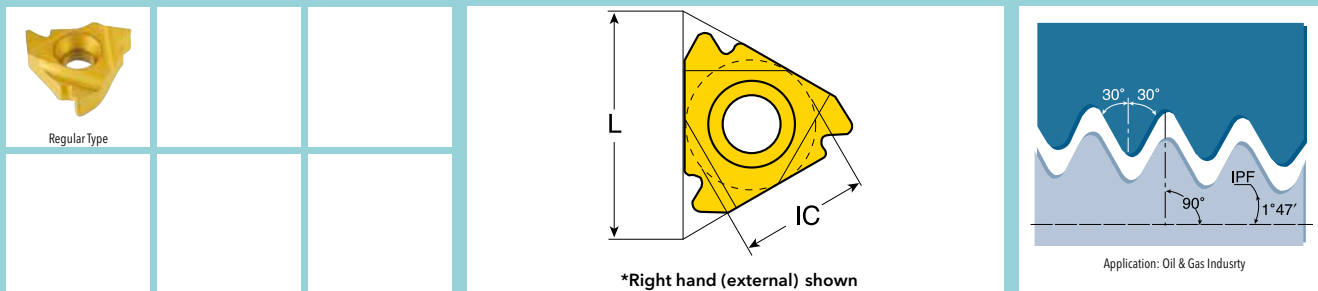

Designation	Thread Type	Hand	Insert Type	IC (inch)	TPI	L (inch)	Taper IPF	Grade	
								T77010	T79030
16ER8APIRD	External	Right	Regular	0.375	8	0.630	0.750		
16ER10APIRD	External	Right	Regular	0.375	10	0.630	0.750		
16IR8APIRD	Internal	Right	Regular	0.375	8	0.630	0.750		
16IR10APIRD	Internal	Right	Regular	0.375	10	0.630	0.750		

● = P ● = M ● = K ● = N ● = S ○ = H

TOTHREAD API - OIL THREADS

EXTERNAL & INTERNAL - API V-TYPE (API SPEC 74-1994)

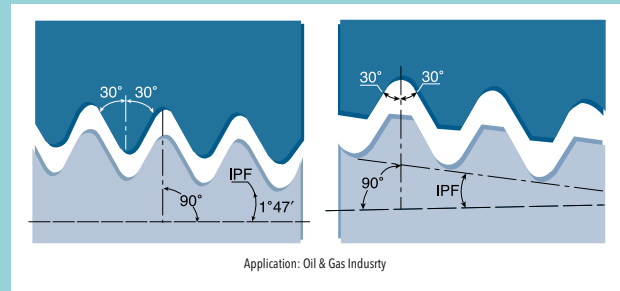
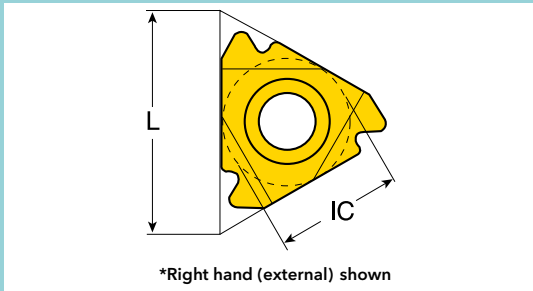

Designation	Thread Type	Hand	Insert Type	IC (inch)	TPI	L (inch)	Taper IPF	Connection Number	Grade	T77010	T9030
22ER5API403	External	Right	Regular	0.500	5	0.866	3.000	2-3/8" / 4-1/2" REG			
27ER4API382	External	Right	Regular	0.625	4	1.063	2.000	NC23 / NC50			
27ER4API383	External	Right	Regular	0.625	4	1.063	3.000	NC56 / NC77			
27ER4API502	External	Right	Regular	0.625	4	1.063	2.000	6-5/8" REG			
27ER4API503	External	Right	Regular	0.625	4	1.063	3.000	5-1/2" 7-5/8"			
22IR5API403	Internal	Right	Regular	0.500	5	0.866	3.000	2-3/8" / 4-1/2" REG			
27IR4API382	Internal	Right	Regular	0.625	4	1.063	2.000	NC23 / NC50			
27IR4API383	Internal	Right	Regular	0.625	4	1.063	3.000	NC56 / NC77			
27IR4API502	Internal	Right	Regular	0.625	4	1.063	2.000	6-5/8" REG			
27IR4API503	Internal	Right	Regular	0.625	4	1.063	3.000	5-1/2" 7-5/8"			

● = P ● = M ● = K ● = N ● = S ○ = H

EXTERNAL & INTERNAL - API BUTTRESS CASING (ANSI B1.9-1973 CLASS 2)



Regular Type

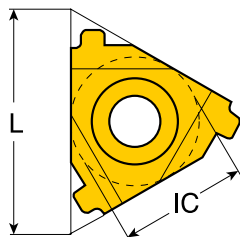

*Right hand (external) shown

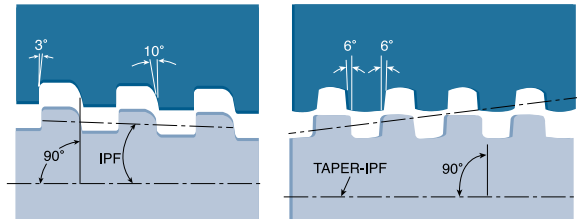

Application: Oil & Gas Industry

Designation	Thread Type	Hand	Insert Type	IC (inch)	TPI	L (inch)	Taper IPF	Connection Number	Grade	TT9030			
22ER5BUT0.75	External	Right	Regular	0.500	5	0.866	0.750	4-1/2"/13-3/8"	●				
22ER5BUT1.0	External	Right	Regular	0.500	5	0.866	1.000	16"/20"					
22IR5BUT0.75	Internal	Right	Regular	0.500	5	0.866	0.750	4-1/2"/13-3/8"					
22IR5BUT1.0	Internal	Right	Regular	0.500	5	0.866	1.000	16"/20"					

● = P ● = M ● = K ● = N ● = S ○ = H

TOTHREAD API - OIL THREADS

EXTERNAL & INTERNAL - API EXTREME LINE CASTING (ANSI B1.9-1973 CLASS 2)

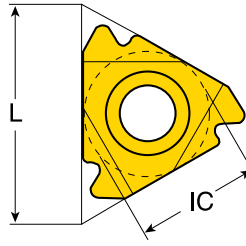
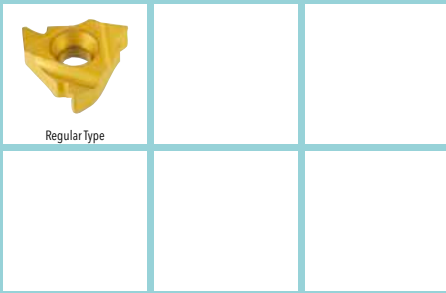

*Right hand (external) shown

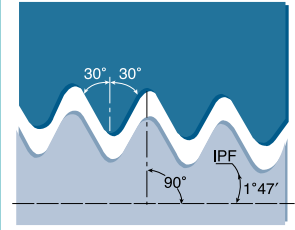

Application: Oil & Gas Industry

Designation	Thread Type	Hand	Insert Type	IC (inch)	TPI	L (inch)	Taper IPF	Connection Number	Grade				
22ER5EL1.25	External	Right	Regular	0.500	5	0.866	1.250	8-5/8"/10-3/4"					
22ER6EL1.5	External	Right	Regular	0.500	5	0.866	1.500	5" 7-5/8"					
22IR5EL1.25	Internal	Right	Regular	0.500	5	0.866	1.250	8-5/8"/10-3/4"					
22IR6EL1.5	Internal	Right	Regular	0.500	5	0.866	1.500	5" 7-5/8"					

● = P ● = M ● = K ● = N ● = S ○ = H

EXTERNAL & INTERNAL - (API SPEC 5B-8-1996), REGULAR AND M-TYPE

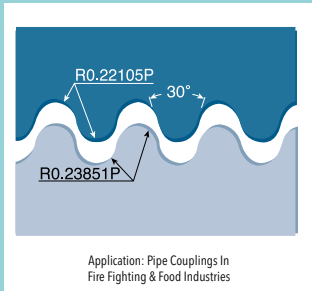
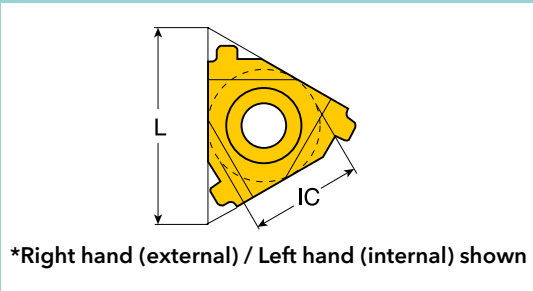
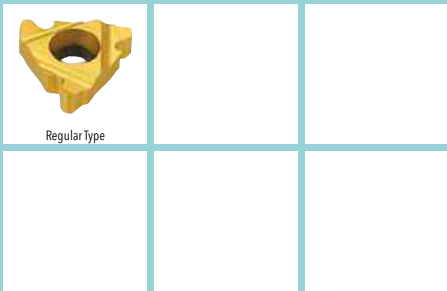

Designation	Thread Type	Hand	Insert Type	IC (inch)	TPI	L (inch)	X (inch)	Y (inch)	Grade	TT7010	TT9030		
16EL6RND	External	Left	Regular	0.375	6	0.630	0.059	0.067					
16EL8RND	External	Left	Regular	0.375	8	0.630	0.055	0.051					
16EL10RND	External	Left	Regular	0.375	10	0.630	0.043	0.047					
22EL4RND	External	Left	Regular	0.500	4	0.866	0.087	0.091					
22EL6RND	External	Left	Regular	0.500	6	0.866	0.059	0.067					
27EL4RND	External	Left	Regular	0.625	4	1.063	0.087	0.091					
16ER6RND	External	Right	Regular	0.375	6	0.630	0.059	0.067				●	
16ER8RND	External	Right	Regular	0.375	8	0.630	0.055	0.051				●	
16ER10RND	External	Right	Regular	0.375	10	0.630	0.043	0.047				●	
16ERM6RND	External	Right	M-Type	0.375	6	0.630	0.059	0.067				●	
22ER4RND	External	Right	Regular	0.500	4	0.866	0.087	0.091				●	
22ER6RND	External	Right	Regular	0.500	6	0.866	0.059	0.067				●	
27ER4RND	External	Right	Regular	0.625	4	1.063	0.087	0.091					
16IL6RND	Internal	Left	Regular	0.375	6	0.630	0.055	0.059					
16IL8RND	Internal	Left	Regular	0.375	8	0.630	0.055	0.055				●	
16IL10RND	Internal	Left	Regular	0.375	10	0.630	0.043	0.047					
22IL4RND	Internal	Left	Regular	0.500	4	0.866	0.087	0.091					
22IL6RND	Internal	Left	Regular	0.500	6	0.866	0.059	0.067					
27IL4RND	Internal	Left	Regular	0.625	4	1.063	0.087	0.091					
16IR6RND	Internal	Right	Regular	0.375	6	0.630	0.055	0.059				●	
16IR8RND	Internal	Right	Regular	0.375	8	0.630	0.055	0.055				●	
16IR10RND	Internal	Right	Regular	0.375	10	0.630	0.043	0.047				●	
16IRM6RND	Internal	Right	M-Type	0.375	6	0.630	0.055	0.059		●			
22IR4RND	Internal	Right	Regular	0.500	4	0.866	0.087	0.091				●	
22IR6RND	Internal	Right	Regular	0.500	6	0.866	0.059	0.067				●	
27IR4RND	Internal	Right	Regular	0.625	4	1.063	0.087	0.091					

● = P ● = M ● = K ● = N ● = S ○ = H

GENERAL TECHNICAL INFORMATION

TOTHTHREAD™ THREADING TOOL HOLDERS DESIGNATION SYSTEM

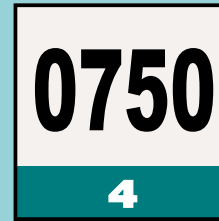

1 CLAMPING SYSTEM

S - Screw clamping

2 APPLICATION

E - External
I - Internal

4 SHANK SIZE

External tool holders
Shank : h x b

0750: .75" x .75"

Internal tool holders
Shank: Diameter d

0750: Diameter .75"

3 HAND OF TOOL

R - Right hand
L - Left hand

SER

SEL

GENERAL TECHNICAL INFORMATION

TOTHREAD™ THREADING TOOL HOLDERS DESIGNATION SYSTEM

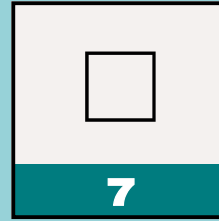

5 TOOL LENGTH

inch

- D** - 2.5
- F** - 3.25
- H** - 4.0
- K** - 5.0
- L** - 5.5
- M** - 6.0
- P** - 7.0
- R** - 8.0
- S** - 10.0
- T** - 12.0
- U** - 14.0
- V** - 16.0

6 INSERT SIZE







L (mm)	IC
06	5/32"
08	3/16"
08U	3/16"
11	1/4"
16	3/8"
22	1/2"
22U	1/2"
27	5/8"
27U	5/8"

7 OPTIONAL SPECIFICATIONS

- U** - For U-type inserts
- B** - Bore for coolant
- C** - Carbide shank
- SP** - Special
- O** - Offset style
- A** - API (oil)



THREADING HOLDER.

Designation	Description	Page
	TOPTHREAD SER/L	1246
	TOPTHREAD SER/L U	1248
	TOPTHREAD SIR/L	1250
	TOPTHREAD SIR/L U	1252
	TOPTHREAD SIR/L C-type	1254
	TOPTHREAD SIR/L U C-type	1255

EXTERNAL THREADING TOOLHOLDERS

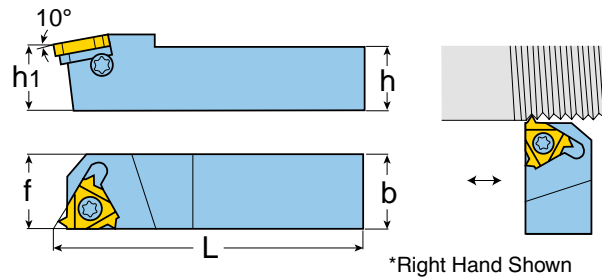

Designation	h	b	l	f
SER0375H11	0.375	0.375	4.000	0.430
SEL0375D16	0.375	0.375	2.500	0.630
SER0375D16	0.375	0.375	2.500	0.630
SEL0500F16	0.500	0.500	3.250	0.630
SER0500F16	0.500	0.500	3.250	0.630
SEL0625H16	0.625	0.625	4.000	0.630
SER0625H16	0.625	0.625	4.000	0.630
SEL0750K16	0.750	0.750	5.000	0.750
SER0750K16	0.750	0.750	5.000	0.750
SEL1000M16	1.000	1.000	6.000	1.000
SER1000M16	1.000	1.000	6.000	1.000
SEL1250P16	1.250	1.250	7.000	1.250
SER1250P16	1.250	1.250	7.000	1.250
SEL1000M22	1.000	1.000	6.000	1.000
SER1000M22	1.000	1.000	6.000	1.000
SEL1250P22	1.250	1.250	7.000	1.250
SER1250P22	1.250	1.250	7.000	1.250
SEL1000M27	1.000	1.000	6.000	1.000
SER1000M27	1.000	1.000	6.000	1.000
SER1250P27	1.250	1.250	7.000	1.250
SER1500R27	1.500	1.500	8.000	1.500

EXTERNAL THREADING TOOLHOLDERS

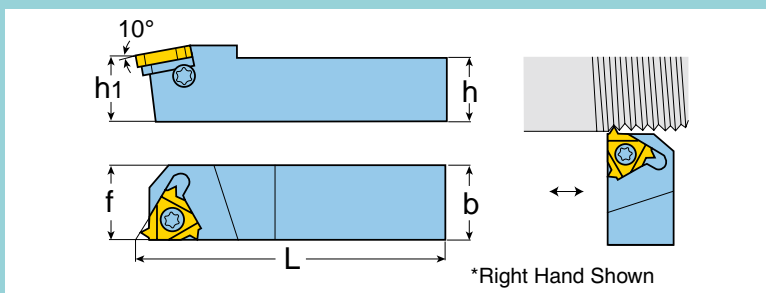

HARDWARE							
	Accepts Insert Series	Anvil Left	Anvil Right	Insert Screw	Anvil Screw	Seat Screw Wrench	Torx Driver
SER0375H11	11ER...	-	-	S11	-	-	DS-T08W
SEL0375D16	16EL...	AI16	-	S16	A16	DS-T10T	DS-T10T
SER0375D16	16ER...	-	AE16	S16	A16	DS-T10T	DS-T10T
SEL0500F16	16EL...	AI16	-	S16	A16	DS-T10T	DS-T10T
SER0500F16	16ER...	-	AE16	S16	A16	DS-T10T	DS-T10T
SEL0625H16	16EL...	AI16	-	S16	A16	DS-T10T	DS-T10T
SER0625H16	16ER...	-	AE16	S16	A16	DS-T10T	DS-T10T
SEL0750K16	16EL...	AI16	-	S16	A16	DS-T10T	DS-T10T
SER0750K16	16ER...	-	AE16	S16	A16	DS-T10T	DS-T10T
SEL1000M16	16EL...	AI16	-	S16	A16	DS-T10T	DS-T10T
SER1000M16	16ER...	-	AE16	S16	A16	DS-T10T	DS-T10T
SEL1250P16	16EL...	AI16	-	S16	A16	DS-T10T	DS-T10T
SER1250P16	16ER...	-	AE16	S16	A16	DS-T10T	DS-T10T
SEL1000M22	22EL...	AI22	-	S22	A22	DS-T20T	DS-T20T
SER1000M22	22ER...	-	AE22	S22	A22	DS-T20T	DS-T20T
SEL1250P22	22EL...	AI22	-	S22	A22	DS-T20T	DS-T20T
SER1250P22	22ER...	-	AE22	S22	A22	DS-T20T	DS-T20T
SEL1000M27	27EL...	AI27	-	S27	A27	DS-T25T	DS-T25T
SER1000M27	27ER...	-	AE27	S27	A27	DS-T25T	DS-T25T
SER1250P27	27ER...	-	AE27	S27	A27	DS-T25T	DS-T25T
SER1500R27	27ER...	-	AE27	S27	A27	DS-T25T	DS-T25T



EXTERNAL THREADING TOOLHOLDERS - U TYPE

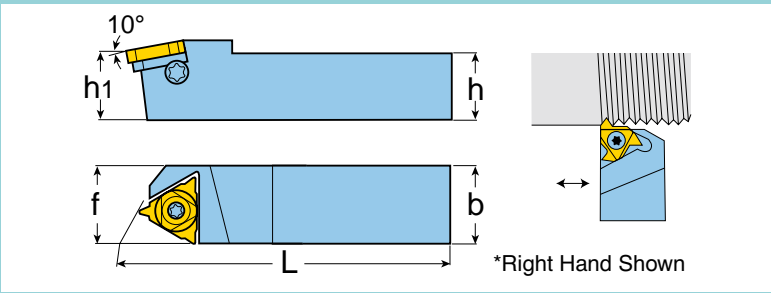

Designation	h	b	l	f
SEL1250P22U	1.250	1.250	7.000	1.250
SER1250P22U	1.250	1.250	7.000	1.250
SER1250P27U	1.250	1.250	7.000	1.250



EXTERNAL THREADING TOOLHOLDERS - U TYPE

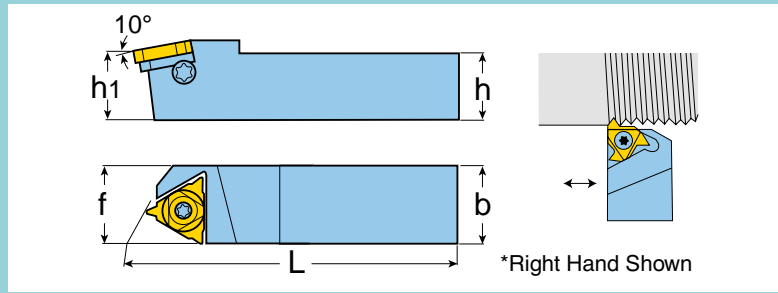

HARDWARE							
	Accepts Insert Series	Anvil Left	Anvil Right	Insert Screw	Anvil Screw	Seat Screw Wrench	Torx Driver
SEL1250P22U	22UERL...	AI22U	-	S22	A22	DS-T20T	DS-T20T
SER1250P22U	22UERL...	-	AE22U	S22	A22	DS-T20T	DS-T20T
SER1250P27U	27UERL...	-	AE27U	S27	A27	DS-T25T	DS-T25T

INTERNAL THREADING TOOLHOLDERS

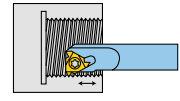
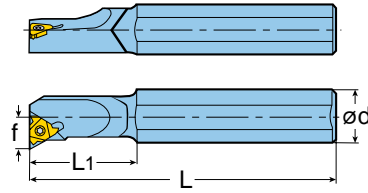
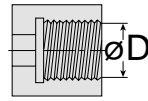

*Right Hand Shown

Designation	d	L	L1	Dmin	f
SIL0265K08	0.625	5.000	0.710	0.315	0.210
SIR0265K08	0.625	5.000	0.710	0.315	0.210
SIL0375H11	0.380	4.000	-	0.470	0.290
SIL0375K11	0.620	5.000	1.000	0.470	0.260
SIR0375H11	0.380	4.000	-	0.470	0.290
SIR0375K11	0.620	5.000	1.000	0.470	0.260
SIL0500L11	0.620	5.500	1.250	0.630	0.320
SIR0500L11	0.620	5.500	1.250	0.630	0.320
SIL0500M16	0.620	6.000	1.250	0.640	0.390
SIR0500M16	0.620	6.000	1.250	0.640	0.390
SIL0625P16	0.750	7.000	1.500	0.750	0.450
SIR0625P16	0.750	7.000	1.500	0.750	0.450
SIL0750P16	0.750	7.000	-	1.000	0.510
SIR0750P16	0.750	7.000	-	1.000	0.510
SIL1000R16	1.000	8.000	-	1.200	0.650
SIR1000R16	1.000	8.000	-	1.200	0.650
SIL1250S16	1.250	10.000	-	1.420	0.770
SIR1250S16	1.250	10.000	-	1.420	0.770
SIL1500T16	1.500	12.000	-	1.650	0.900
SIR1500T16	1.500	12.000	-	1.650	0.900
SIL0750P22	0.750	7.000	-	0.950	0.510
SIR0750P22	0.750	7.000	-	0.950	0.510
SIL1000R22	1.000	8.000	-	1.200	0.710
SIR1000R22	1.000	8.000	-	1.200	0.710
SIL1250S22	1.250	10.000	-	1.500	0.850
SIR1250S22	1.250	10.000	-	1.500	0.850
SIL1500T22	1.500	12.000	-	1.750	0.980
SIR1500T22	1.500	12.000	-	1.750	0.980
SIL1250S27	1.250	10.000	-	1.560	0.880
SIR1250S27	1.250	10.000	-	1.560	0.880
SIL1500T27	1.500	12.000	-	1.800	1.000
SIR1500T27	1.500	12.000	-	1.800	1.000
SIR2000U27	2.000	14.000	-	2.300	1.250
SIR2500V27	2.500	16.000	-	2.700	1.500

INTERNAL THREADING TOOLHOLDERS

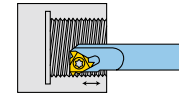
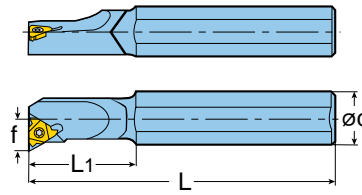
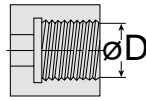

*Right Hand Shown

HARDWARE



Accepts Insert Series

Anvil Left

Anvil Right

Insert Screw

Anvil Screw

Seat Screw Wrench

Torx Driver

SIL0265K08	08IL...	-	-	SR14	-	-	DS-T06F
SIR0265K08	08IR...	-	-	SR14	-	-	DS-T06F
SIL0375H11	11IL...	-	-	S11	-	-	DS-T08W
SIL0375K11	11IL...	-	-	S11	-	-	DS-T08W
SIR0375H11	11IR...	-	-	S11	-	-	DS-T08W
SIR0375K11	11IR...	-	-	S11	-	-	DS-T08W
SIL0500L11	11IL...	-	-	S11	-	-	DS-T08W
SIR0500L11	11IR...	-	-	S11	-	-	DS-T08W
SIL0500M16	16IL...	AE16	-	S16	A16	DS-T10T	DS-T10T
SIR0500M16	16IR...	-	AI16	S16	A16	DS-T10T	DS-T10T
SIL0625P16	16IL...	AE16	-	S16	A16	DS-T10T	DS-T10T
SIR0625P16	16IR...	-	AI16	S16	A16	DS-T10T	DS-T10T
SIL0750P16	16IL...	AE16	-	S16	A16	DS-T10T	DS-T10T
SIR0750P16	16IR...	-	AI16	S16	A16	DS-T10T	DS-T10T
SIL1000R16	16IL...	AE16	-	S16	A16	DS-T10T	DS-T10T
SIR1000R16	16IR...	-	AI16	S16	A16	DS-T10T	DS-T10T
SIL1250S16	16IL...	AE16	-	S16	A16	DS-T10T	DS-T10T
SIR1250S16	16IR...	-	AI16	S16	A16	DS-T10T	DS-T10T
SIL1500T16	16IL...	AE16	-	S16	A16	DS-T10T	DS-T10T
SIR1500T16	16IR...	-	AI16	S16	A16	DS-T10T	DS-T10T
SIL0750P22	22IL...	AE22	-	S22	A22	DS-T20T	DS-T20T
SIR0750P22	22IR...	-	AI22	S22	A22	DS-T20T	DS-T20T
SIL1000R22	22IL...	AE22	-	S22T	A22	DS-T20T	DS-T20T
SIR1000R22	22IR...	-	AI22	S22	A22	DS-T20T	DS-T20T
SIL1250S22	22IL...	AE22	-	S22	A22	DS-T20T	DS-T20T
SIR1250S22	22IR...	-	AI22	S22	A22	DS-T20T	DS-T20T
SIL1500T22	22IL...	AE22	-	S22	A22	DS-T20T	DS-T20T
SIR1500T22	22IR...	-	AI22	S22	A22	DS-T25T	DS-T20T
SIL1250S27	27IL...	AE22	-	S27	A27	DS-T25T	DS-T25T
SIR1250S27	27IR...	-	AI27	S27	A27	DS-T25T	DS-T25T
SIL1500T27	27IL...	AE27	-	S27	A27	DS-T25T	DS-T25T
SIR1500T27	27IR...	-	AI27	S27	A27	DS-T25T	DS-T25T
SIR2000U27	27IR...	-	AI27	S27	A27	DS-T25T	DS-T25T
SIR2500V27	27IR...	-	AI27	S27	A27	DS-T25T	DS-T25T

INTERNAL THREADING TOOLHOLDERS - U TYPE

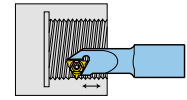
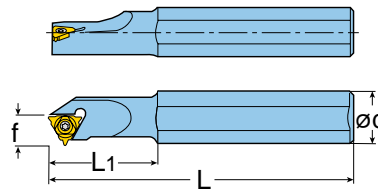
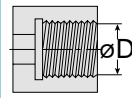

*Right Hand Shown

Designation	d	L	L1	Dmin	f
SIL0310K08U	0.625	5.000	0.825	0.355	0.250
SIR0310K08U	0.625	5.000	0.825	0.355	0.250
SIR1250S22U	1.250	10.000	-	1.500	1.010
SIR1500T22U	1.500	12.000	-	1.850	1.120
SIL1250S27U	1.250	10.000	-	1.560	0.980
SIR1250S27U	1.250	10.000	-	1.560	0.980

INTERNAL THREADING TOOLHOLDERS - U TYPE

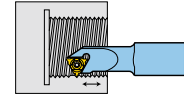
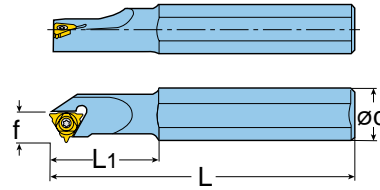
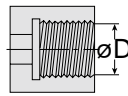

*Right Hand Shown

HARDWARE



Accepts Insert Series

Anvil Left

Anvil Right

Insert Screw

Anvil Screw

Seat Screw Wrench

Torx Driver

SIL0310K08U	08UIRL...	-	-	SR14-558	-	-	DS-T06F
SIR0310K08U	08UIRL...	-	-	SR14-558	-	-	DS-T06F
SIR1250S22U	22UIRL...	-	AI22U	S22	A22	DS-T20T	DS-T20T
SIR1500T22U	22UIRL...	-	AI22U	S22	A22	DS-T20T	DS-T20T
SIL1250S27U	27UIRL...	AE27	-	S27	A27	DS-T25T	DS-T25T
SIR1250S27U	27UIRL...	-	AI27U	S27	A27	DS-T25T	DS-T25T

INTERNAL THREADING TOOLHOLDERS - CARBIDE

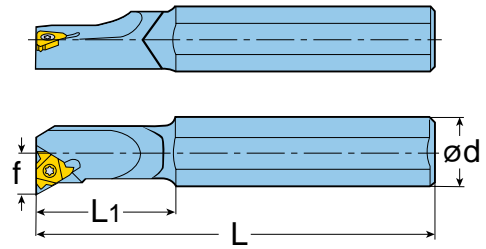
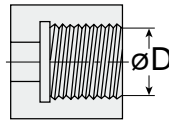

*Right Hand Shown

Designation	d	L	L1	Dmin	f
SIR0205H06C	0.236	4.000	1.000	0.250	0.170
SIR0265K08C	0.315	5.000	1.200	0.315	0.210
SIR0375M11C	0.380	6.000	-	0.500	0.290
SIL0500P11C	0.500	7.000	-	0.600	0.330
SIR0500P11C	0.500	7.000	-	0.600	0.330
SIL0625R16C	0.630	8.000	-	0.750	0.460
SIR0625R16C	0.630	8.000	-	0.750	0.460

HARDWARE



Accepts Insert Series



Insert Screw



Torx Driver

Designation	Accepts Insert Series	Insert Screw	Torx Driver
SIR0205H06C	06IR...	SR14-552	DS-T06F
SIR0265K08C	08IR...	SR14-558	DS-T06F
SIR0375M11C	11IR...	S11	DS-T08S
SIL0500P11C	11IL...	S11	DS-T08S
SIR0500P11C	11IR...	S11	DS-T08S
SIL0625R16C	16IL...	S16	DS-T10T
SIR0625R16C	16IR...	S16	DS-T10T

INTERNAL THREADING TOOLHOLDERS - CARBIDE

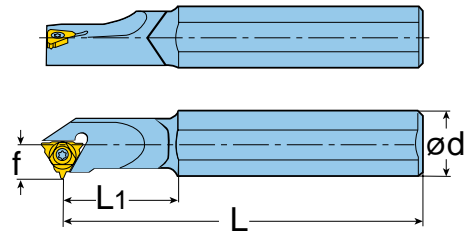
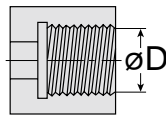

*Right Hand Shown

Designation	d	L	L1	Dmin	f
SIR0310K08UC	0.315	5.000	1.400	0.355	0.250

HARDWARE



Accepts Insert Series



Insert Screw



Torx Driver

SIR0310K08UC	08UJRL...	SR14-558	DS-T06F
--------------	-----------	----------	---------

Ingersoll



CUTTING TOOLS
CUTTING TOOLS

TECHNICAL INFORMATION.

Cutting Tools

GENERAL TECHNICAL INFORMATION

THREADING INSERTS - TYPES AND PROFILES

Partial Profile

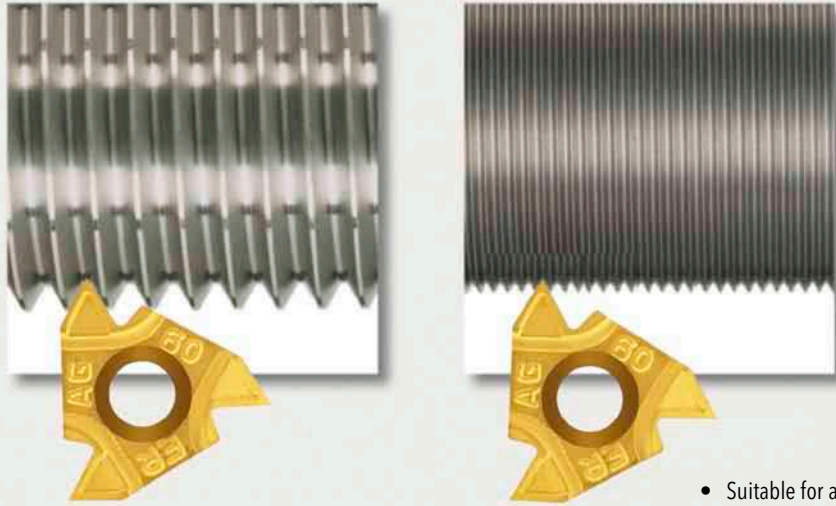

- Suitable for a wide range of pitches with a common angle (60° or 55°)
- Inserts with small root-corner radius suitable for the smallest pitch range.
- Additional operations to complete the outer/internal diameter is necessary.
- Not recommended for mass production.
- Eliminates the need for different inserts.

Full Profile

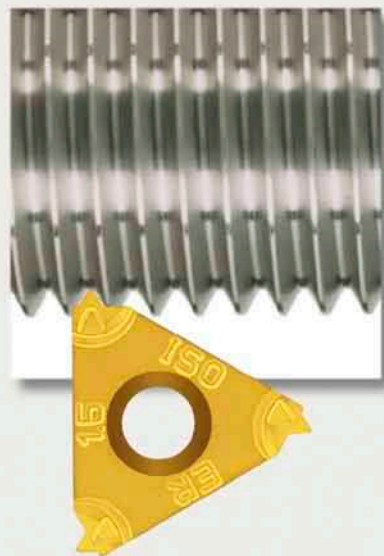

- Performs complete thread profile.
- Root corner radius is suitable only for the relevant pitch.
- Recommended for mass production.
- Suitable for one profile only.

GENERAL TECHNICAL INFORMATION

THREAD TURNING METHODS

External Thread

Right-Hand Thread

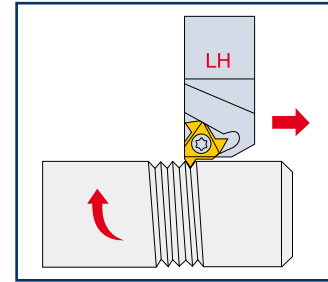
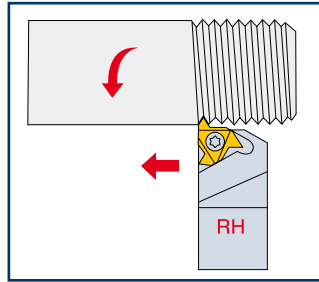

Change anvil to negative

Left-Hand Thread

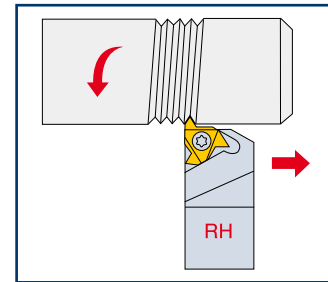
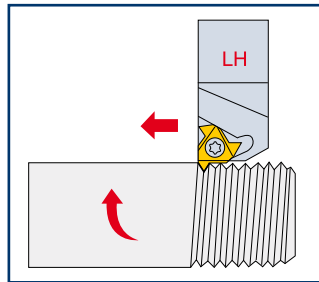

Change anvil to negative

Internal Thread

Right-Hand Thread

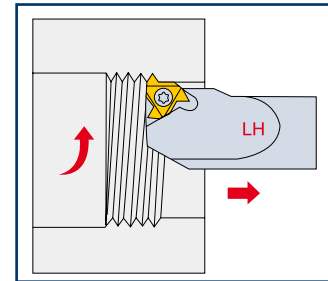
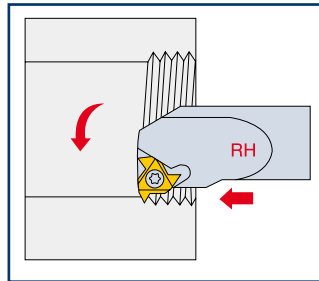

Change anvil to negative

Left-Hand Thread

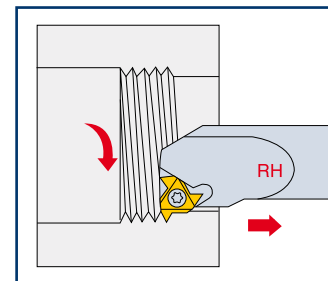
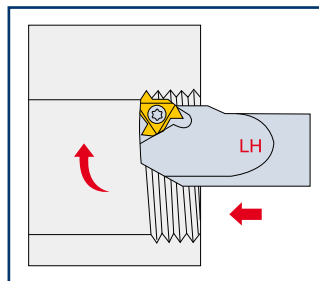

Change anvil to negative

GENERAL TECHNICAL INFORMATION



MINI-TOOL FEATURES

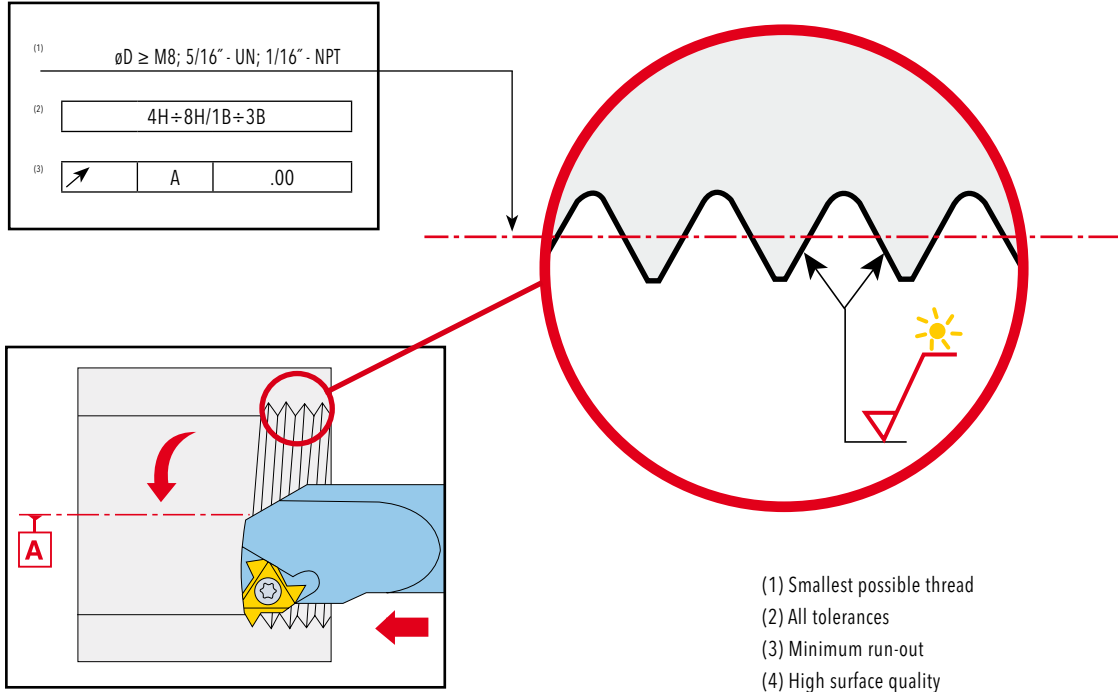

M-TYPE THREADING INSERT ACCURACY

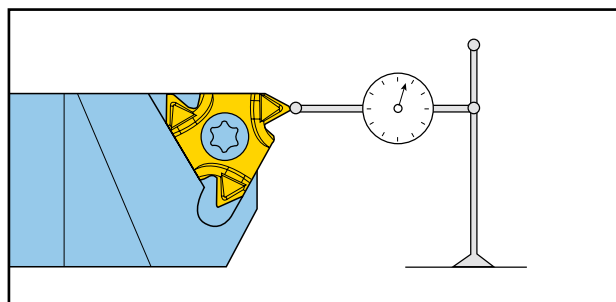
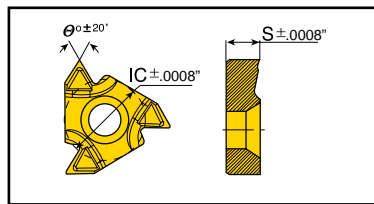

Insert indexability accuracy $\pm .0006''$

GENERAL TECHNICAL INFORMATION



THREAD HELIX ANGLE AND ANVIL SELECTION

Helix Angle λ Evaluation

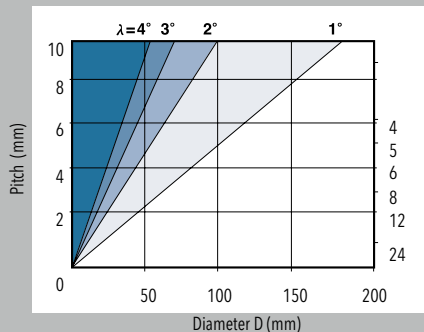

⁽¹⁾ β - effective inclination angle

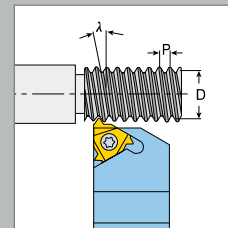

$$\operatorname{tg} \lambda = \frac{1 \times P}{3.14 \times D}$$

P - Pitch mm
D - Effective diameter of thread mm
 λ - Angle of inclination

$$\lambda^\circ = \frac{20 \times P}{D}$$

Anvil Selection According to Thread Helix Angle λ

Standard									
Thread Helix Angle / Angle d'hélice		>4°	3°-4°	2°-3°	1°-2°	0°-1°	Negative Anvils / Assises négatives		
Inclination Angle / Angle d'inclinaison b		4,5°	3,5°	2,5°	1,5°	0,5°	-0,5°	4,5°	
I(IC)	Tool holder / Porte-outil	Anvil Designation / Désignation de l'assise							
16 (3/8)	EX RH OR IN LH	AE 16 +4.5	AE 16 +3,5	AE 16 +2,5	AE 16	AE 16 +0,5	AE 16 -0,5	AE 16 -1,5	
	EX LH OR IN RH	AI 16 +4.5	AI 16 +3,5	AI 16 +2,5	AI 16	AI 16 +0,5	AI 16 -0,5	AI 16 -1,5	
22 (1/2)	EX RH OR IN LH	AE 22 +4.5	AE 22 +3,5	AE 22 +2,5	AE 22	AE 22 +0,5	AE 22 -0,5	AE 22 -1,5	
	EX LH OR IN RH	AI 22 +4.5	AI 22 +3,5	AI 22 +2,5	AI 22	AI 22 +0,5	AI 22 -0,5	AI 22 -1,5	
27 (5/8)	EX RH OR IN LH	AE 27 +4.5	AE 27 +3,5	AE 27 +2,5	AE 27	AE 27 +0,5	AE 27 -0,5	AE 27 -1,5	
	EX LH OR IN RH	AI 27 +4.5	AI 27 +3,5	AI 27 +2,5	AI 27	AI 27 +0,5	AI 27 -0,5	AI 27 -1,5	
22U (1/2U)	EX RH OR IN LH	AE 22U +4.5	AE 22U +3,5	AE 22U +2,5	AE 22U	AE 22U +0,5	AE 22U -0,5	AE 22U -1,5	
	EX LH OR IN RH	AI 22U +4.5	AI 22U +3,5	AI 22U +2,5	AI 22U	AI 22U +0,5	AI 22U -0,5	AI 22U -1,5	
27U (5/8U)	EX RH OR IN LH	AE 27U +4.5	AE 27U +3,5	AE 27U +2,5	AE 27U	AE 27U +0,5	AE 27U -0,5	AE 27U -1,5	
	EX LH OR IN RH	AI 27U +4.5	AI 27U +3,5	AI 27U +2,5	AI 27U	AI 27U +0,5	AI 27U -0,5	AI 27U -1,5	

EX RH = External Right Hand, EX LH = External Left Hand; IN RH = Internal Right Hand, IN LH = Internal Left Hand

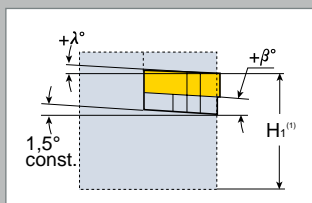

⁽¹⁾ H_1 Remains constant for every anvil combination

Anvils for negative inclination β used when turning:

RH thread with **LH** holder or
LH thread with **RH** holder.

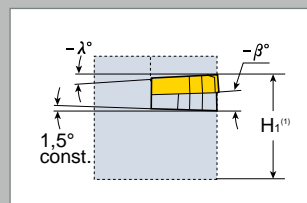

Anvils for positive inclination β used when turning:

RH thread with **RH** holder or
LH thread with **LH** holder.

GENERAL TECHNICAL INFORMATION



THREAD HELIX ANGLE AND ANVIL SELECTION

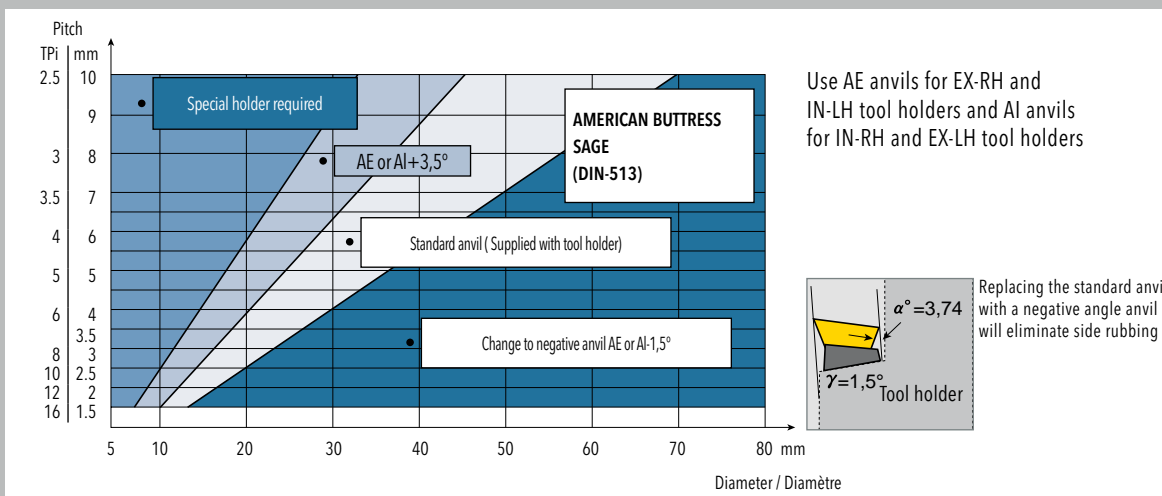
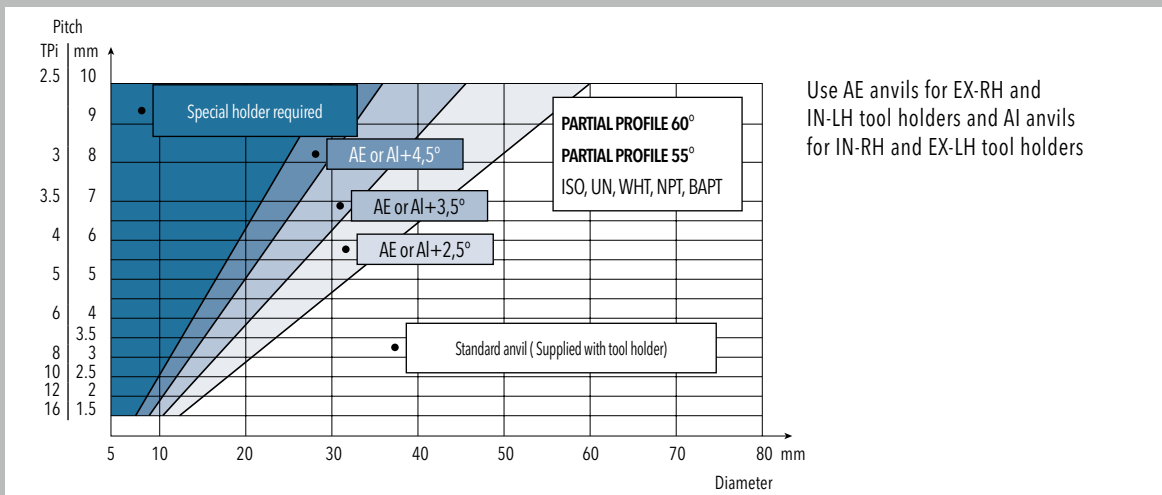
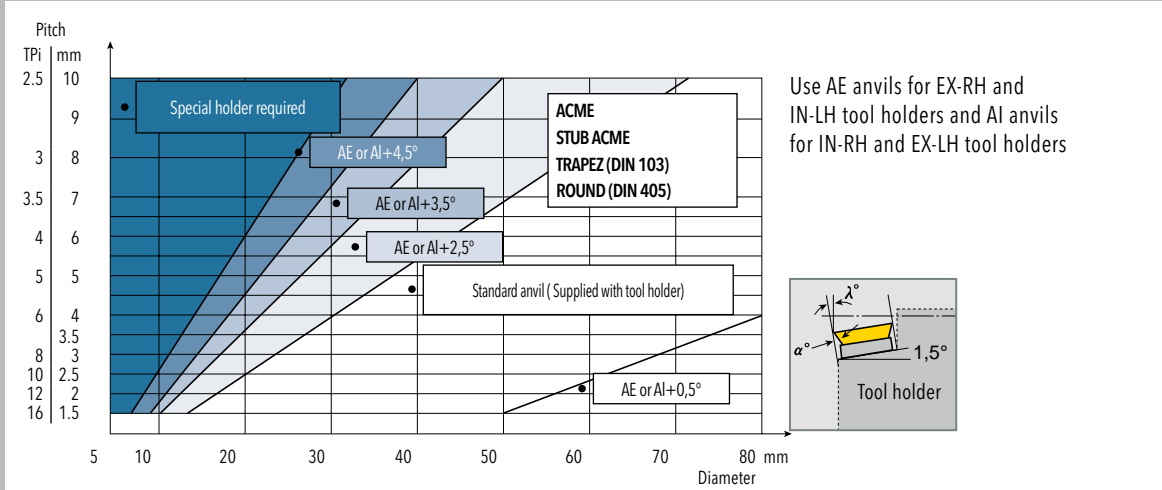

GENERAL TECHNICAL INFORMATION



FLANK CLEARANCE AND EFFECTIVE INCLINATION ANGLE

Inclination angle β of the cutting edges corresponds to a specific thread helix angle λ and insures equal clearance angle on both sides of insert.



- α - Flank clearance angle
- λ - Helix angle
- β - Effective inclination angle is achieved by selecting the suitable anvil.

INFED METHODS FOR THREADING OPERATIONS

Flank feed

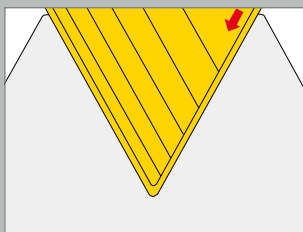

Radial infeed

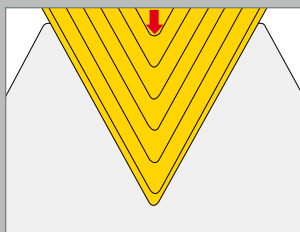

Alternating flank infeed

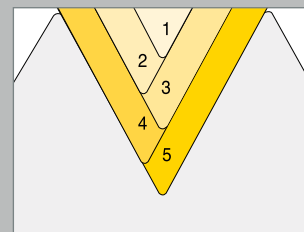

Flank equal

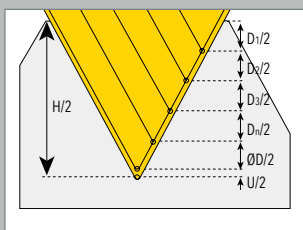

$$\frac{D_1}{2} = \frac{D_2}{2} = \frac{D_3}{2} = \frac{D_n}{2}$$

Flank diminishing

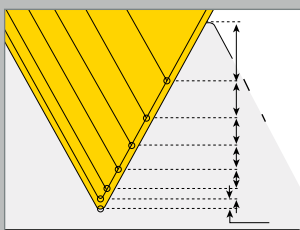

$$\frac{D_1}{2} > \frac{D_2}{2} > \frac{D_3}{2} > \frac{D_n}{2} > \frac{D_{n+1}}{2}$$

H - Depth of thread profile
 D - Depth of pass
 U - Depth of finishing pass

GENERAL TECHNICAL INFORMATION

CUTTING DATA

Number of Cutting Passes for Regular Type Inserts

Pitch	inch TPI	0.5 48	1.0 24	1.5 16	2.0 12	2.5 10	3.0 8	4.0 6	6.0 4
Number of Passes		4-6	5-9	5-12	6-14	7-15	8-17	10-20	11-22

- For mini-tools (06IR or 08IR) add 1 - 3 passes. Increase for hard materials.

Maximum depth of first cut for CNC control External Threading - M-Type Inserts

Full Profile	Pitch	TPI	Insert Designation	No. of passes Min. Max.		Max. Depth for First Pass (D ₁) mm									
						Low Carbon Steel Eq. Dim.		High Carbon Steel Eq. Dim.		Alloy Steel Eq. Dim.		Stainless Steel Eq. Dim.		Nonferrous Aluminum Eq. Dim.	
ISO Metric	1.00		16 ERM 1.00 ISO	5	9	.013	.020	.012	.018	.011	.016	.009	.013	.019	.028
	1.25		16 ERM 1.25 ISO	6	11	.017	.025	.015	.022	.013	.020	.011	.016	.023	.035
	1.50		16 ERM 1.50 ISO	6	12	.018	.027	.016	.024	.015	.022	.012	.018	.025	.038
	1.75		16 ERM 1.75 ISO	8	13	.019	.028	.017	.026	.015	.023	.012	.019	.026	.040
	2.00		16 ERM 2.00 ISO	8	14	.020	.030	.018	.027	.016	.024	.013	.019	.028	.041
	2.50		16 ERM 2.50 ISO	10	15	.021	.031	.019	.028	.017	.025	.013	.020	.029	.044
	3.00		16 ERM 3.00 ISO	12	17	.022	.033	.020	.030	.018	.026	.014	.022	.031	.046
American UN		24	16 ERM 24 UN	5	9	.013	.020	.012	.018	.011	.016	.009	.013	.019	.028
		20	16 ERM 20 UN	6	10	.017	.025	.015	.022	.013	.020	.011	.016	.023	.035
		18	16 ERM 18 UN	6	11	.018	.027	.016	.024	.015	.022	.012	.018	.025	.038
		16	16 ERM 16 UN	7	12	.019	.028	.017	.025	.015	.022	.012	.018	.026	.039
		14	16 ERM 14 UN	7	13	.018	.027	.016	.024	.015	.022	.011	.016	.025	.038
		12	16 ERM 12 UN	8	14	.022	.033	.018	.027	.016	.024	.013	.019	.028	.041
British BSW		8	16 ERM 8 UN	12	17	.019	.028	.020	.030	.018	.026	.014	.022	.031	.046
		19	16 ERM 19 W	6	11	.014	.020	.013	.018	.011	.016	.008	.012	.019	.029
		16	16 ERM 16 W	7	12	.019	.028	.017	.025	.015	.022	.012	.018	.026	.039
		14	16 ERM 14 W	8	13	.020	.030	.018	.027	.016	.024	.013	.019	.028	.041
NPT		11	16 ERM 11 W	9	14	.017	.025	.016	.023	.014	.021	.011	.017	.024	.036
		18	16 ERM 18 NPT	10	20	.009	.014	.009	.013	.007	.011	.006	.009	.013	.020
		14	16 ERM 14 NPT	13	26	.009	.014	.009	.013	.007	.011	.005	.009	.013	.020
		11.5	16 ERM 11.5 NPT	15	24	.011	.016	.009	.014	.009	.013	.007	.010	.015	.022
Round		8	16 ERM 8 NPT	17	30	.012	.018	.011	.016	.010	.015	.008	.012	.017	.025
		6	16 ERM 6 RND	9	20	.017	.025	.015	.022	.013	.020	.011	.016	.023	.035
Partial Profile 60°	0.50-1.50	48-16	16 ERM A 60		(1)	.009	.013	.008	.012	.007	.010	.006	.008	.012	.018
	1.75-3.00	14-8	16 ERM G 60			.020	.030	.018	.027	.016	.024	.013	.019	.028	.041
	0.50-3.00	48-8	16 ERM AG 60			.009	.014	.009	.013	.007	.011	.006	.009	.013	.020
	3.50-5.00	7-5	22 ERM N 60			.016	.024	.015	.022	.013	.020	.011	.016	.022	.034
Partial Profile 55°	1.75-3.00	14-8	16 ERM G 55			.020	.030	.018	.027	.016	.024	.013	.019	.028	.041
	0.50-3.00	48-8	16 ERM AG 55			.009	.013	.008	.012	.007	.010	.006	.008	.012	.018

⁽¹⁾As per the number of passes for the relevant pitch.
For CT3000, TT6010 and K10, reduce depth of first cut by 30%.

GENERAL TECHNICAL INFORMATION

CUTTING DATA

Maximum depth of first cut for CNC control Internal Threading - M-Type Inserts

Full Profile	Pitch (mm)	TPI	Insert Designation	No. of passes		Max. Depth for First Pass (D ₁) inch									
						Low Carbon Steel		High Carbon Steel		Alloy Steel		Stainless Steel		Nonferrous Aluminum	
				Min.	Max.	Eq.	Dim.	Eq.	Dim.	Eq.	Dim.	Eq.	Dim.	Eq.	Dim.
ISO Metric	1.50		11 IRM 1.50 ISO	10	20	.008	.012	.007	.011	.006	.009	.005	.007	.011	.019
	1.00		16 IRM 1.00 ISO	9	16	.006	.008	.005	.007	.004	.006	.004	.005	.008	.011
	1.25		16 IRM 1.25 ISO	9	16	.007	.011	.007	.010	.006	.009	.005	.007	.011	.015
	1.50		16 IRM 1.50 ISO	10	20	.008	.012	.007	.011	.006	.009	.005	.008	.011	.019
	1.75		16 IRM 1.75 ISO	11	18	.008	.013	.007	.011	.007	.010	.006	.008	.011	.018
	2.00		16 IRM 2.00 ISO	12	21	.009	.013	.008	.012	.007	.010	.006	.008	.012	.018
	2.50		16 IRM 2.50 ISO	14	21	.009	.013	.008	.012	.007	.011	.006	.009	.013	.019
	3.00		16 IRM 3.00 ISO	16	22	.009	.014	.009	.013	.007	.011	.006	.009	.013	.020
American UN		20	16 IRM 20 UN	7	13	.008	.012	.007	.011	.006	.009	.005	.008	.011	.017
		18	16 IRM 18 UN	8	15	.008	.012	.007	.011	.006	.009	.005	.008	.011	.017
		16	16 IRM 16 UN	11	19	.008	.012	.007	.011	.006	.009	.005	.008	.011	.017
		14	16 IRM 14 UN	11	20	.008	.012	.007	.011	.007	.010	.005	.007	.011	.017
		12	16 IRM 12 UN	12	21	.009	.013	.008	.012	.007	.011	.006	.009	.013	.019
		8	16 IRM 8 UN	14	20	.009	.014	.009	.013	.007	.011	.006	.009	.013	.020
British BSW		19	16 IRM 19 W	7	12	.011	.016	.010	.015	.009	.013	.007	.010	.015	.023
		16	16 IRM 16 W	9	14	.010	.015	.009	.014	.008	.012	.007	.010	.014	.022
		14	16 IRM 14 W	10	16	.011	.016	.009	.015	.009	.013	.007	.011	.015	.022
		11	16 IRM 11 W	12	19	.012	.018	.011	.016	.010	.015	.008	.012	.017	.025
NPT		14	16 IRM 14 NPT	21	35	.005	.008	.005	.007	.004	.006	.003	.005	.007	.011
		11.5	16 IRM 11.5 NPT	21	33	.007	.010	.006	.009	.006	.008	.004	.006	.009	.014
		8	16 IRM 8 NPT	20	34	.009	.013	.008	.012	.007	.010	.006	.008	.012	.018
Round		6	16 IRM 6 RND	12	24	.012	.018	.011	.016	.009	.015	.008	.012	.017	.025
Partial Profile 60°	0.50 - 1.25	48-16	06 IRM A 60			.009	.013	.008	.012	.007	.010	.006	.008	.012	.018
	0.50 - 1.50	48-16	08 IRM A 60		(1)	.005	.008	.005	.007	.004	.006	.003	.005	.007	.011
	0.50 - 1.50	48-16	11 IRM A 60			.005	.008	.005	.007	.004	.006	.003	.005	.007	.011
	0.50 - 1.50	48-16	16 IRM A 60			.005	.008	.005	.007	.004	.006	.003	.005	.007	.011
	1.75 - 3.00	14-8	16 IRM G 60			.009	.013	.008	.012	.007	.010	.006	.008	.012	.018
	0.50 - 3.00	48-8	16 IRM AG 60			.006	.008	.005	.007	.004	.007	.004	.006	.008	.011
	3.50 - 5.00	7-5	22 IRM N 60			.009	.013	.008	.012	.007	.011	.006	.009	.013	.019
Partial Profile 55°	1.75 - 3.00	14-8	16 IRM G 55			.013	.020	.012	.018	.011	.016	.009	.013	.019	.028
	0.50 - 3.00	48-8	16 IRM AG 55			.006	.008	.007	.007	.004	.006	.004	.005	.008	.011

(1) As per the number of passes for the relevant pitch.
For CT3000, TT6010 and K10, reduce depth of first cut by 30%.

GENERAL TECHNICAL INFORMATION



CUTTING DATA

CUTTING SPEED RANGE BY WORKPIECE MATERIAL AND CARBIDE GRADES

Material	Brinell HB	Coated / Revêtu			Uncoated / Non revêtu	
		TT7010	TT9030	TT8010	Cermet CT3000	
Hardness		Cutting speed / Vitesse de coupe (SFM)				
Carbon steel	0.2 %C	150	520	590	340	610
	0.45%C	190	490	520	320	580
	0.83%C	250	430	460	280	500
Alloy steel	<200	430	430	280	500	
	200 - 250	390	390	260	460	
	275 - 325	310	330	200	360	
	325 - 375	260	260	170	310	
	375 - 425	200	200	130	230	
Stainless steel	Mart.	175 - 225	490	520	320	580
		275 - 325	340	360	170	310
		135 - 175	260	330	220	403
	Aust.	375 - 425	230	260	150	270
Cast steel	Carbon	<150	490	560	320	580
		150 - 200	360	360	240	420
	Alloyed	200 - 250	330	330	210	380
	Allié	250 - 300	260	160	170	310
Malleable iron	Short chip / Copeau court	110 - 145		260		
	Long chip / Copeau long	200 - 250		330		
Cast iron	Low tensile / Forte résis. tract	180		430		
	Fonte grise	High tensile / Faible résis. tract	250		330	
Nodular iron	Ferritic / Ferrite	160		430		
	Fonte modulaire	Pearlitic / Perrique	250		330	
Chilled cast iron		400		70		
	Fonte blanche					
Bronze alloy / Alliage bronze		120 - 200		390		
Lead alloy / Alliage plomb		80 - 150		490		
Brass & red / Lation & alliage rouge		60 - 110		390		
Phosphor bronze / Bronze au phosphore		85 - 110		330		
Aluminum alloys / Alliages d'aluminium		150 - 200		820		
Aluminum alloys, cast / Alliages d'aluminium					980	

GRADE INFORMATION

GRADE NAME	ISO CLASS	GRADE DESCRIPTION
P30	P20 - P30	Carbide grade for carbon and cast steels, works well at medium to low cutting speeds
K10 or UF10	K10 - K30	Carbide grade for non ferrous metals, aluminum and cast iron
TT6010	K10 - K20 P10 ~ P25	PVD TiN coated micrograin for free cutting untreated alloy steels (below 30 HRc), for stainless steels and cast iron
TT7010	P15 - P35	PVD TiN coated grade for treated and hard alloy steels (25 HRc & up) at medium to low cutting speeds
TT8010	P30 - P50 K25 - K40	PVD TiN coated grade for low cutting speed. Works well with wide range of stainless steels
TT9030	P20 - P40 K20 - K30	PVD TiAlN coated sub-micrograin grade for variety of materials. First choice grade. Works particularly well in stainless steels and exotic materials at medium to high cutting speeds

GENERAL TECHNICAL INFORMATION



TROUBLE SHOOTING (EN)

PROBLEM

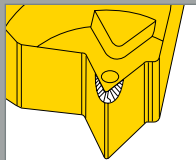

Premature wear

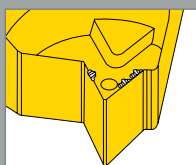

Chipped edge

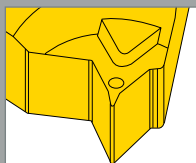

Plastic deformation

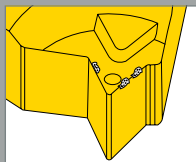

Built-up edge

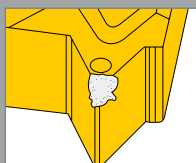

Broken nose during 1st pass

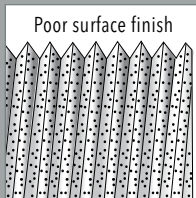

Poor surface finish

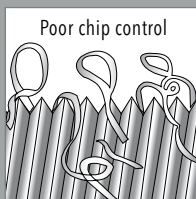

Poor chip control

CAUSED BY

- Cutting speed too high
- Infeed depth too small
- Highly abrasive material
- Inadequate coolant supply
- Wrong inclination anvil
- Wrong turned dia. prior to threading
- Insert is above centerline

- Cutting speed too high
- Depth of cut too large
- Wrong grade
- Poor chip control
- Inadequate coolant supply
- Center height incorrect

- Excessive heat in cutting zone
- Wrong grade
- Inadequate coolant supply

- Cutting edge too cold
- Wrong grade
- Inadequate coolant supply

- Cutting speed too low
- Depth of cut too large
- Wrong grade
- Wrong turned dia. prior to threading
- Corner height incorrect
- Infeed depth too shallow
- Wrong inclination anvil
- Tool overhang too long

- Wrong cutting speed
- Excessive heat in cutting zone
- Poor chip control
- Inadequate coolant supply
- Wrong inclination anvil
- Tool overhang too long
- Center height incorrect

- Excessive heat in cutting zone
- Wrong grade
- Inadequate coolant supply
- Wrong turned dia. prior to threading

SOLUTION

- Reduce RPM
- Increase depth of cut
- Modify flank infeed
- Use coated grade
- Apply coolant
- Reselect anvil
- Check turned dia.
- Check center height

- Reduce RPM
- Reduce depth of cut
- Use coated grade
- Use tougher grade
- Modify flank infeed
- Apply coolant
- Adjust center height

- Reduce RPM
- Reduce depth of cut
- Check turned dia.
- Use coated grade
- Use harder grade
- Apply more coolant

- Increase RPM
- Increase depth of cut
- Use coated grade
- Apply coolant

- Increase RPM
- Reduce depth of cut
- Increase number of infeed passes
- Use tougher grade
- Check turned dia.
- Adjust center height
- Modify flank infeed
- Reselect anvil
- Reduce tool overhang

- Increase RPM
- Reduce RPM
- Reduce depth of cut
- Modify flank infeed
- Apply coolant
- Reselect anvil
- Reduce tool overhang
- Check center height

- Reduce RPM
- Change depth of cut
- Use coated grade
- Check turned dia.
- Use M-type insert
- Apply coolant
- Check turned dia.

Ingersoll



T-CLAMP.

Cutting Tools

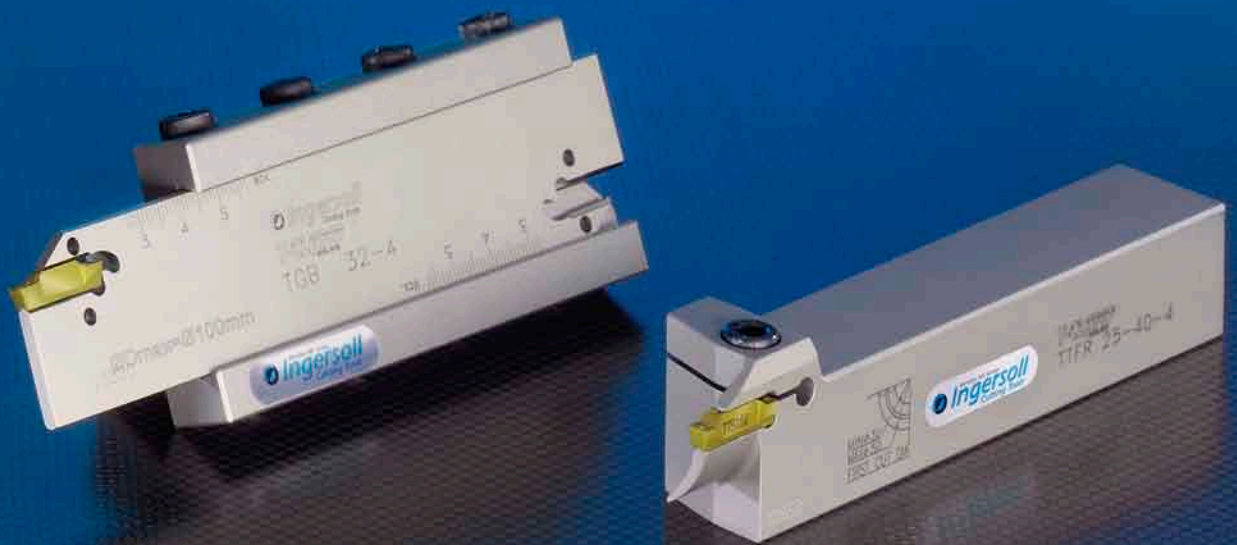

Member IMC Group
Ingersoll
Cutting Tools

GENERAL TECHNICAL INFORMATION

TOCLAMP^{ULTRA+}

INSERT DESIGNATION SYSTEM

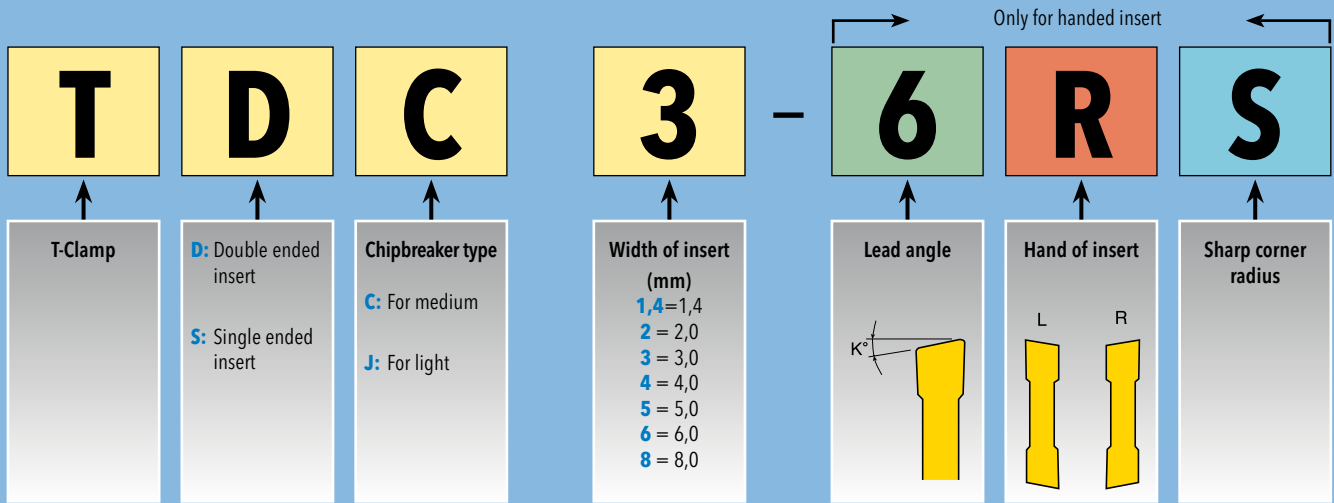

PARTING & GROOVING

**TURNING, GROOVING
& FACE MACHINING**

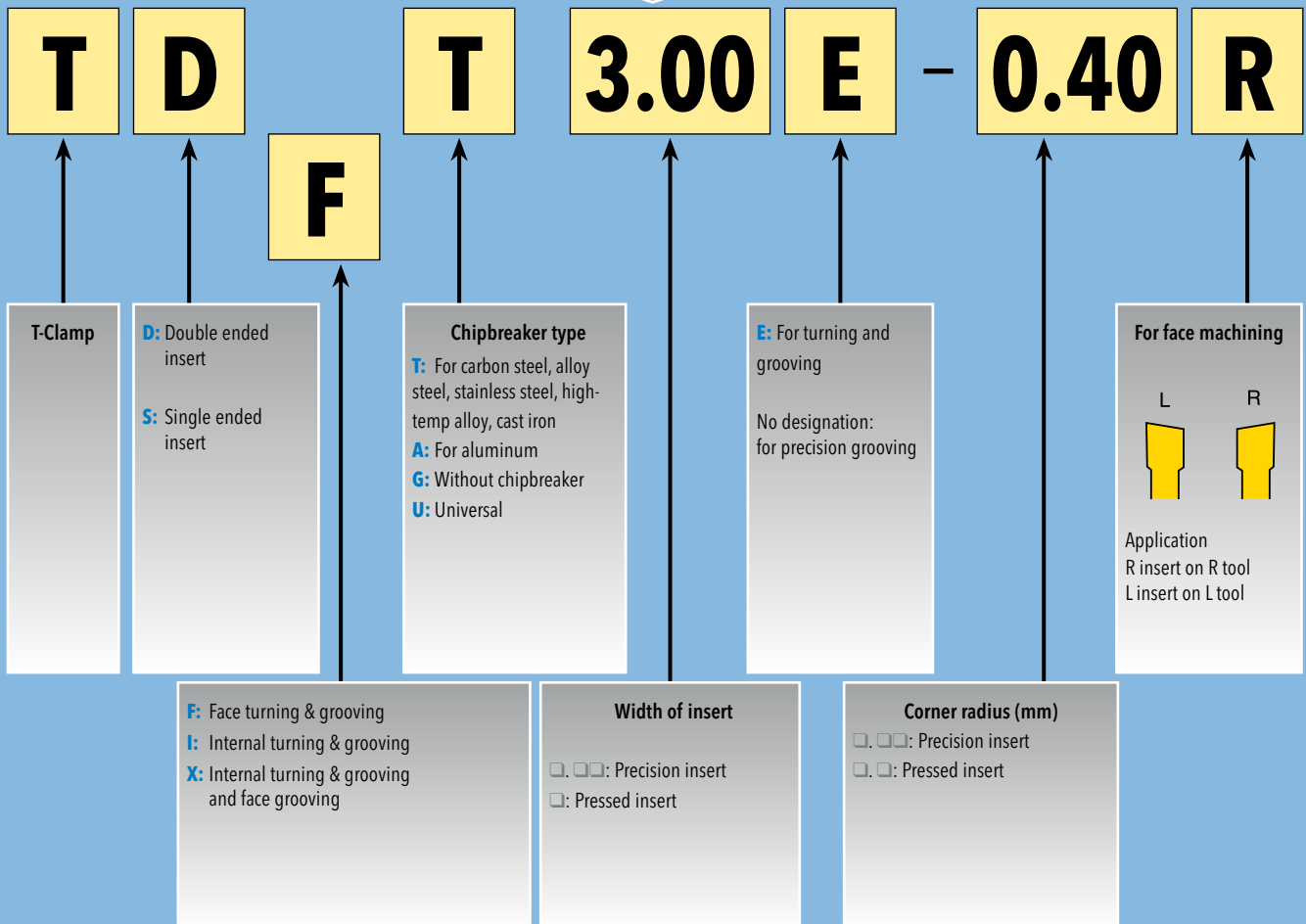

GENERAL TECHNICAL INFORMATION

TOCLAMP^{ULTRA}



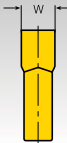

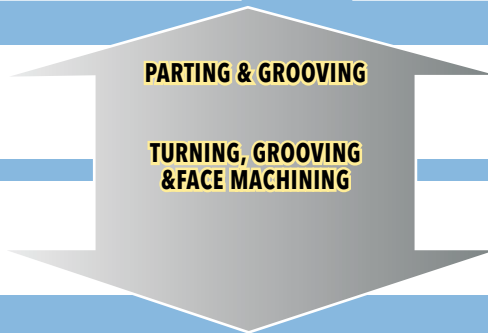





INSERT DESIGNATION SYSTEM

TI	M	C	1.6	6	R
T-Clamp	M: Tolerance W = ±.004"	Chipbreaker type C: For general purpose parting and grooving J: For lighter feed rates and softer materials or where more positive geometry is needed.	Width of insert (mm) 	Lead angle 6=6° Blank=0°	Hand of insert R: Right hand L: Left hand N: Neutral



TI	P	V	-	4.00	E	0.40
T-Clamp	P: Tolerance W = ±.0008"	Chipbreaker type V: For precision grooving and turning / profiling with various widths, radii and shapes		Width of insert .xxx=inch x.xxx=metric	Cutting edge E: Honed No Designation: Sharp	Corner radius Corner radius or 1/2 W full radius .xxx=inch x.xx=metric

T-CLAMP.

	Designation	Description	Page
	T₀CLAMP^{ULTRA+} TDC	Double ended inserts for parting and grooving	1274
	T₀CLAMP^{ULTRA+} TSC	Single ended inserts for parting and deep grooving	1276
	T₀CLAMP^{ULTRA+} TDXU-E	Double ended inserts for parting and grooving	1278
	T₀CLAMP^{ULTRA+} TSC	Single ended inserts for parting and deep grooving	1280
	T₀CLAMP^{ULTRA+} TDXU-E	Pressed inserts for external turning & grooving, internal turning & grooving, face turning & grooving, and parting	1281
	T₀CLAMP^{ULTRA+} TDT-00E	Precision inserts for external turning and grooving	1282
	T₀CLAMP^{ULTRA+} TDT-E	Pressed inserts for external turning and grooving	1284
	T₀CLAMP^{ULTRA+} TDT-E CE	Pressed ceramic inserts for external turning and grooving	1285
	T₀CLAMP^{ULTRA+} TDT-RU (Full Radius)	Full radius pressed inserts for external turning, grooving and profiling	1285
	T₀CLAMP^{ULTRA+} TDT-E (Full Radius)	Full radius precision inserts for external turning, grooving and profiling	1286
	T₀CLAMP^{ULTRA+} TDFT-E	Pressed inserts for face grooving and turning	1287
	T₀CLAMP^{ULTRA+} TDFT-E CE	Pressed ceramic inserts for face grooving and turning	1287

	Designation	Description	Page
	TOCLAMP^{ULTRA+} TDT	Precision inserts for external grooving only	1288
	TOCLAMP^{ULTRA+} TDIT.00E	Precision inserts for internal turning, grooving and profiling	1289
	TOCLAMP^{ULTRA+} TDIT-E	Pressed inserts for internal turning, grooving and profiling	1289
	TOCLAMP^{ULTRA+} TDIT-E CE	Pressed ceramic inserts for internal turning, grooving and profiling	1290
	TOCLAMP^{ULTRA+} TDIT-E (Full radius)	Full radius precision inserts for internal turning, grooving and profiling	1290
	TOCLAMP^{ULTRA+} TDA	Full radius precision inserts for aluminum machining	1291
	TOCLAMP^{ULTRA+} TSA	PCD tipped inserts for aluminum wheel machining	1291
	TOCLAMP^{ULTRA} TIMC	T-Clamp Ultra inserts for parting and grooving, "C" Type Chipbreakers	1292
	TOCLAMP^{ULTRA} TIMJ	T-Clamp Ultra inserts for parting and grooving, "J" Type Chipbreakers	1294
	TOCLAMP^{ULTRA} TIPV-E	T-Clamp Ultra inserts for precision turning and grooving, "V" Type Chipbreakers	1295
	TOCLAMP^{ULTRA} TIPV-E (Full radius)	T-Clamp Ultra inserts for precision turning and grooving, "V" type chipbreakers	1296
	TOCLAMP^{ULTRA} TIPV	T-clamp Ultra inserts for precision turning and grooving, "V" type chipbreakers	1297

DOUBLE ENDED INSERTS FOR PARTING AND GROOVING

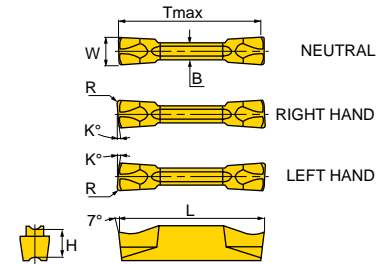

Designation	Hand	Insert Seat Size	W ±.05 (mm)	W ±.002 (inch)	R (inch)	L (inch)	K°	H (inch)	Tmax (inches)
TDJ2-15L	Left	2	2.0	0.079	0.0080	0.79	15	0.185	0.748
TDJ2-15LS	Left	2	2.0	0.079	0.0008	0.77	15	0.185	0.748
TDJ2-6L	Left	2	2.0	0.079	0.0080	0.79	6	0.185	0.748
TDJ3-15L	Left	3	3.0	0.118	0.0080	0.79	15	0.185	0.748
TDJ3-15LS	Left	3	3.0	0.118	0.0008	0.77	15	0.185	0.748
TDJ3-6L	Left	3	3.0	0.118	0.0080	0.79	6	0.185	0.748
TDJ4-4L	Left	4	4.0	0.157	0.0120	0.79	4	0.185	0.748
TDJ5-4L	Left	5	5.0	0.197	0.0120	0.98	4	0.205	0.945
TDJ1.4	Neutral	1	1.4	0.055	0.0060	0.63	-	0.157	0.591
TDJ2	Neutral	2	2.0	0.079	0.0080	0.79	-	0.185	0.748
TDJ3	Neutral	3	3.0	0.118	0.0080	0.79	-	0.185	0.748
TDJ4	Neutral	4	4.0	0.157	0.0120	0.79	-	0.185	0.748
TDJ5	Neutral	5	5.0	0.197	0.0120	0.98	-	0.205	0.945
TDJ6	Neutral	6	6.0	0.236	0.0120	0.98	-	0.205	0.945
TDJ2-15R	Right	2	2.0	0.079	0.0080	0.79	15	0.185	0.748
TDJ2-15RS	Right	2	2.0	0.079	0.0008	0.77	15	0.185	0.748
TDJ2-6R	Right	2	2.0	0.079	0.0080	0.79	6	0.185	0.748
TDJ3-15R	Right	3	3.0	0.118	0.0080	0.79	15	0.185	0.748
TDJ3-15RS	Right	3	3.0	0.118	0.0008	0.77	15	0.185	0.748
TDJ3-6R	Right	3	3.0	0.118	0.0080	0.79	6	0.185	0.748
TDJ4-4R	Right	4	4.0	0.157	0.0120	0.79	4	0.185	0.748
TDJ5-4R	Right	5	5.0	0.197	0.0120	0.98	4	0.205	0.945

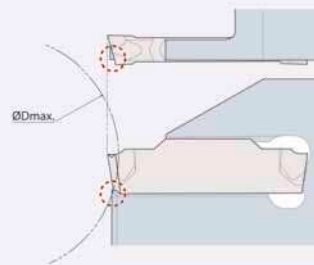

Max. Dia. parting & grooving

TDJ 2- 15RS /LS : Ø 1.07

TSJ 3- 15R /L : Ø 4.03

TDJ 3- 15RS /LS : Ø 1.31

The others : Unlimited

DOUBLE ENDED INSERTS FOR PARTING AND GROOVING

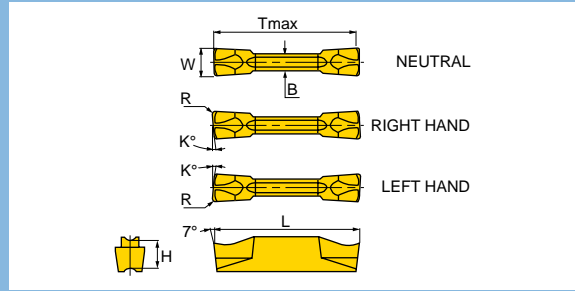

Part Number	Grade	CT3000	K10	TT5100	TT7220	TT8020	TT9030			
TDJ2-15L					●	●				
TDJ2-15LS					●	●				
TDJ2-6L			●		●	●				
TDJ3-15L					●	●				
TDJ3-15LS					●	●				
TDJ3-6L			●		●	●	●			
TDJ4-4L					●	●				
TDJ5-4L			●		●	●				
TDJ1.4			●			●	●			
TDJ2			●	●	●	●	●			
TDJ3		●	●		●	●	●			
TDJ4			●		●	●	●			
TDJ5			●		●	●	●			
TDJ6			●		●	●	●			
TDJ2-15R					●	●				
TDJ2-15RS					●	●	●			
TDJ2-6R			●		●	●	●			
TDJ3-15R					●	●				
TDJ3-15RS					●	●	●			
TDJ3-6R			●		●	●	●			
TDJ4-4R			●		●	●	●			
TDJ5-4R			●		●	●				

Use holders TGB, TGBR/L, TGB-MS, TGER/L, TCER/L, TCFR/L, TTER/L, TTER/L-SH, TGF/L, TGFPR/L, TGBFR/L, TFR/L, TFR/L-RN, TFRPR/L, TTIR/L, see pages 1304 - 1308, 1310, 1314 - 1322, 1324 - 1327.

● = P ● = M ● = K ● = N ● = S ○ = H

SINGLE ENDED INSERTS FOR PARTING AND DEEP GROOVING

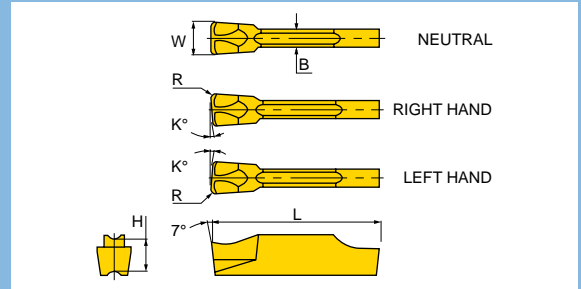
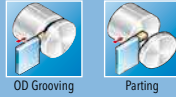

Designation	Hand	Insert Seat Size	W ±.05 (mm)	W ±.002 (inch)	R (inch)	L (inch)	K°	H (inch)
TSJ2-15L	Left	2	2.0	0.079	0.0080	0.79	15	0.185
TSJ2-15LS	Left	2	2.0	0.079	0.0008	0.77	15	0.185
TSJ2-6L	Left	2	2.0	0.079	0.0080	0.79	6	0.185
TSJ3-15L	Left	3	3.0	0.118	0.0080	0.79	15	0.185
TSJ3-15LS	Left	3	3.0	0.118	0.0008	0.77	15	0.185
TSJ3-6L	Left	3	3.0	0.118	0.0080	0.79	6	0.185
TSJ4-4L	Left	4	4.0	0.157	0.0120	0.79	4	0.185
TSJ5-4L	Left	5	5.0	0.197	0.0120	0.98	4	0.205
TSJ2	Neutral	2	2.0	0.079	0.0080	0.79	-	0.185
TSJ3	Neutral	3	3.0	0.118	0.0080	0.79	-	0.185
TSJ4	Neutral	4	4.0	0.157	0.0120	0.79	-	0.185
TSJ5	Neutral	5	5.0	0.197	0.0120	0.98	-	0.205
TSJ6	Neutral	6	6.0	0.236	0.0120	0.98	-	0.205
TSJ2-15R	Right	2	2.0	0.079	0.0080	0.79	15	0.185
TSJ2-15RS	Right	2	2.0	0.079	0.0008	0.77	15	0.185
TSJ2-6R	Right	2	2.0	0.079	0.0080	0.79	6	0.185
TSJ3-15R	Right	3	3.0	0.118	0.0080	0.79	15	0.185
TSJ3-15RS	Right	3	3.0	0.118	0.0008	0.77	15	0.185
TSJ3-6R	Right	3	3.0	0.118	0.0080	0.79	6	0.185
TSJ4-4R	Right	4	4.0	0.157	0.0120	0.79	4	0.185
TSJ5-4R	Right	5	5.0	0.197	0.0120	0.98	4	0.205

Max. Dia. parting & grooving

TDJ 2- 15RS/LS : Ø 1.07

TSJ 3- 15R/L : Ø 4.03

TDJ 3- 15RS/LS : Ø 1.31

The others : Unlimited

SINGLE ENDED INSERTS FOR PARTING AND DEEP GROOVING



OD Grooving



Parting

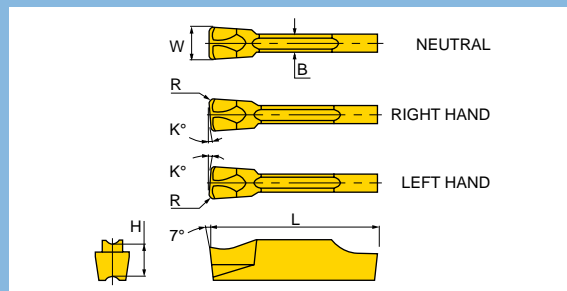

Part Number	Grade	K10	TT7220	TT8020	TT9030					
TSJ2-15L			●	●						
TSJ2-15LS			●	●						
TSJ2-6L		●	●	●						
TSJ3-15L			●	●						
TSJ3-15LS			●	●						
TSJ3-6L		●	●	●						
TSJ4-4L		●	●	●						
TSJ5-4L			●	●						
TSJ2		●	●	●	●					
TSJ3		●	●	●	●					
TSJ4		●	●	●	●					
TSJ5		●	●	●						
TSJ6		●	●	●						
TSJ2-15R			●	●						
TSJ2-15RS			●	●						
TSJ2-6R		●	●	●						
TSJ3-15R			●	●						
TSJ3-15RS			●	●						
TSJ3-6R		●	●	●	●					
TSJ4-4R		●	●	●						
TSJ5-4R			●	●						

Use holders TGB, TGBR/L, TGB-MS, TGER/L, TCER/L, TCFR/L, TTER/L, TTER/L-SH, TGFR/L, TGFR/L, TGBFR/L, TTFR/L, TTFR/L_RN, TTFR/L, TTIR/L, see pages 1304 - 1308, 1310, 1314 - 1322, 1324 - 1327.

● = P ● = M ● = K ● = N ● = S ○ = H

DOUBLE ENDED INSERTS FOR PARTING AND GROOVING

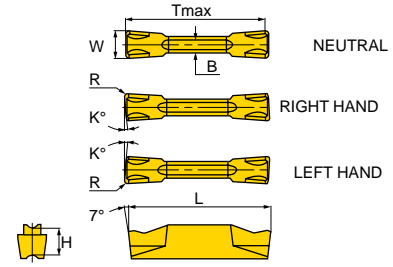
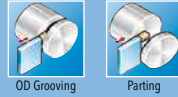

Designation	Hand	Insert Seat Size	W ±.05 (mm)	W ±.002 (inch)	R (inch)	L (inch)	K°	H (inch)	Tmax (inches)
TDC2-15L	Left	2	2.0	0.079	0.0080	0.79	15	0.185	0.748
TDC2-15LS	Left	2	2.0	0.079	0.0008	0.77	15	0.185	0.748
TDC2-6L	Left	2	2.0	0.079	0.0080	0.79	6	0.185	0.748
TDC2-8L	Left	2	2.0	0.079	0.0080	0.79	8	0.185	0.748
TDC3-15L	Left	3	3.0	0.118	0.0080	0.79	15	0.185	0.748
TDC3-15LS	Left	3	3.0	0.118	0.0008	0.79	15	0.185	0.748
TDC3-6L	Left	3	3.0	0.118	0.0080	0.79	6	0.185	0.748
TDC4-15L	Left	4	4.0	0.157	0.0120	0.79	15	0.185	0.748
TDC4-4L	Left	4	4.0	0.157	0.0120	0.79	4	0.185	0.748
TDC5-4L	Left	5	5.0	0.197	0.0120	0.98	4	0.205	0.945
TDC2	Neutral	2	2.0	0.079	0.0080	0.79	-	0.185	0.748
TDC3	Neutral	3	3.0	0.118	0.0080	0.79	-	0.185	0.748
TDC4	Neutral	4	4.0	0.157	0.0120	0.79	-	0.185	0.748
TDC5	Neutral	5	5.0	0.197	0.0120	0.98	-	0.205	0.945
TDC6	Neutral	6	6.0	0.236	0.0120	0.98	-	0.205	0.945
TDC8	Neutral	8	8.0	0.315	0.0160	1.18	-	0.252	1.142
TDC2-15R	Right	2	2.0	0.079	0.0080	0.79	15	0.185	0.748
TDC2-15RS	Right	2	2.0	0.079	0.0008	0.77	15	0.185	0.748
TDC2-6R	Right	2	2.0	0.079	0.0080	0.79	6	0.185	0.748
TDC2-8R	Right	2	2.0	0.079	0.0080	0.79	8	0.185	0.748
TDC3-15R	Right	3	3.0	0.118	0.0080	0.79	15	0.185	0.748
TDC3-15RS	Right	3	3.0	0.118	0.0008	0.77	15	0.185	0.748
TDC3-6R	Right	3	3.0	0.118	0.0080	0.79	6	0.185	0.748
TDC3-6RS	Right	3	3.0	0.118	0.0008	0.79	6	0.185	0.748
TDC4-15R	Right	4	4.0	0.157	0.0120	0.79	15	0.185	0.748
TDC4-4R	Right	4	4.0	0.157	0.0120	0.79	4	0.185	0.748
TDC5-4R	Right	5	5.0	0.197	0.0120	0.98	4	0.205	0.945

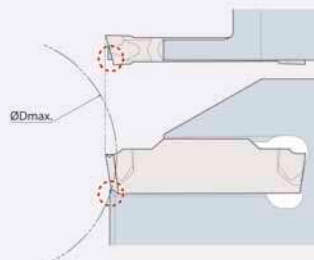

Max. Dia. parting & grooving

- TSC 3-15R / L : Ø3.75
- TDC 3-15RS : Ø1.12
- TSC 3-15RS : Ø1.30
- TDC 4-15R / L : Ø1.14
- TSC 4-15R / L : Ø1.37
- The others : Unlimited

DOUBLE ENDED INSERTS FOR PARTING AND GROOVING

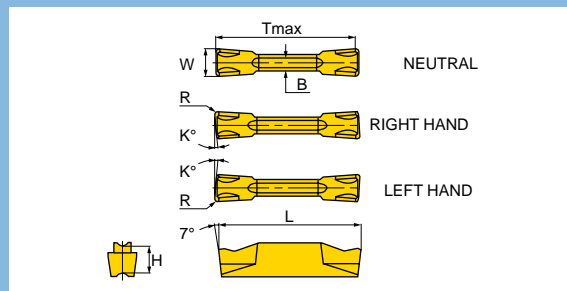

Part Number	Grade	CT3000	K10	TT5100	TT7220	TT8020	TT9030			
TDC2-15L						●				
TDC2-15LS					●	●				
TDC2-6L			●		●	●				
TDC2-8L					●	●				
TDC3-15L					●	●	●			
TDC3-15LS					●	●				
TDC3-6L			●		●	●	●			
TDC4-15L					●	●				
TDC4-4L			●		●	●				
TDC5-4L						●				
TDC2		●	●		●	●	●			
TDC3		●	●	●	●	●	●			
TDC4		●	●		●	●	●			
TDC5			●		●	●	●			
TDC6			●		●	●	●			
TDC8						●	●			
TDC2-15R					●	●				
TDC2-15RS					●	●				
TDC2-6R			●		●	●				
TDC2-8R					●	●				
TDC3-15R					●	●	●			
TDC3-15RS					●	●				
TDC3-6R			●		●	●	●			
TDC3-6RS							●			
TDC4-15R					●	●				
TDC4-4R			●		●	●	●			
TDC5-4R					●	●				

Use holders TGB, TGBR/L, TGB-MS, TGER/L, TCER/L, TCFR/L, TTER/L, TTER/L-SH, TGFR/L, TGFR/L, TGBFR/L, TTFR/L, TTFR/L_RN, TTFR/L, TTIR/L, see pages 1304 - 1308, 1310, 1314 - 1322, 1324 - 1327.

● = P ● = M ● = K ● = N ● = S ○ = H

SINGLE ENDED INSERTS FOR PARTING AND DEEP GROOVING

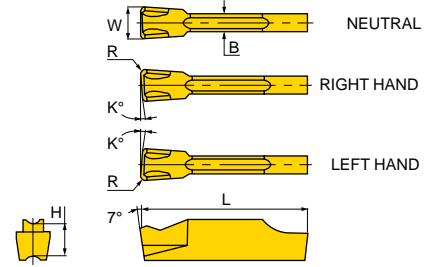

Designation	Hand	Insert Seat Size	W ±.05 (mm)	W ±.002 (inch)	R (inch)	L (inch)	K°	H (inch)	Grade	K10	TT7220	TT8020	TT9030
TSC2-15L	Left	2	2.0	0.079	0.0080	0.79	15	0.185			●	●	
TSC2-15LS	Left	2	2.0	0.079	0.0008	0.77	15	0.185			●	●	
TSC2-6L	Left	2	2.0	0.079	0.0080	0.79	6	0.185		●	●	●	
TSC2-8L	Left	2	2.0	0.079	0.0080	0.79	8	0.185			●	●	
TSC3-15L	Left	3	3.0	0.118	0.0080	0.79	15	0.185			●	●	
TSC3-15LS	Left	3	3.0	0.118	0.0008	0.79	15	0.185			●	●	
TSC3-6L	Left	3	3.0	0.118	0.0080	0.79	6	0.185		●	●	●	
TSC4-15L	Left	4	4.0	0.157	0.0120	0.79	15	0.185			●	●	
TSC4-4L	Left	4	4.0	0.157	0.0120	0.79	4	0.185		●	●	●	
TSC5-4L	Left	5	5.0	0.197	0.0120	0.98	4	0.205			●	●	
TSC2	Neutral	2	2.0	0.079	0.0080	0.79	-	0.185		●	●	●	●
TSC3	Neutral	3	3.0	0.118	0.0080	0.79	-	0.185		●	●	●	●
TSC4	Neutral	4	4.0	0.157	0.0120	0.79	-	0.185		●	●	●	●
TSC5	Neutral	5	5.0	0.197	0.0120	0.98	-	0.205		●	●	●	●
TSC6	Neutral	6	6.0	0.236	0.0120	0.98	-	0.205		●	●	●	●
TSC2-15R	Right	2	2.0	0.079	0.0080	0.79	15	0.185			●	●	
TSC2-15RS	Right	2	2.0	0.079	0.0008	0.77	15	0.185			●	●	
TSC2-6R	Right	2	2.0	0.079	0.0080	0.79	6	0.185		●	●	●	
TSC2-8R	Right	2	2.0	0.079	0.0080	0.79	8	0.185			●	●	
TSC3-15R	Right	3	3.0	0.118	0.0080	0.79	15	0.185			●	●	
TSC3-15RS	Right	3	3.0	0.118	0.0008	0.77	15	0.185			●	●	
TSC3-6R	Right	3	3.0	0.118	0.0080	0.79	6	0.185		●	●	●	●
TSC4-15R	Right	4	4.0	0.157	0.0120	0.79	15	0.185			●	●	
TSC4-4R	Right	4	4.0	0.157	0.0120	0.79	4	0.185		●	●	●	
TSC5-4R	Right	5	5.0	0.197	0.0120	0.98	4	0.205			●	●	

Use holders TGB, TGBR/L, TGB-MS, TGER/L, TCER/L, TCFR/L, TTER/L, TTER/L-SH, TGFR/L, TGFR/L, TGBFR/L, TFR/L, TFR/L_RN, TFR/L, TTIR/L, see pages 1304 - 1308, 1310, 1314 - 1322, 1324 - 1327.

● = P ● = M ● = K ● = N ● = S ○ = H

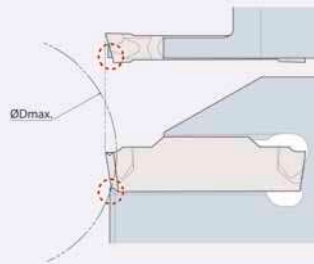

Max. Dia. parting & grooving

- TSC 3- 15R / L : Ø3.75
- TDC 3- 15RS : Ø1.12
- TSC 3- 15RS : Ø1.30
- TDC 4- 15R / L : Ø1.14
- TSC 4- 15R / L : Ø1.37
- The others : Unlimited

PRESSED INSERTS FOR EXTERNAL TURNING & GROOVING,
INTERNAL TURNING & GROOVING, FACE TURNING &
GROOVING, AND PARTING



Face Turning



ID Turning



ID Grooving



OD Turning



OD Grooving



Parting



Face Grooving

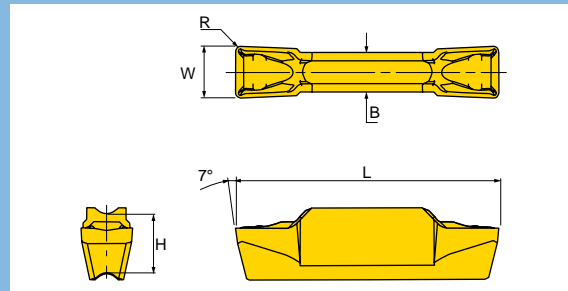

Designation	Insert Seat Size	W ±.002 (inch)	W ±.05 (mm)	R (inch)	R (mm)	L (inch)	H (inch)
TDXU3E-0.3	3	0.118	3.0	0.012	0.30	0.79	0.185
TDXU4E-0.4	4	0.157	4.0	0.016	0.40	0.79	0.185
TDXU5E-0.4	5	0.197	5.0	0.016	0.40	0.98	0.205
TDXU6E-0.4	6	0.236	6.0	0.016	0.40	0.98	0.205
TDXU8E-0.8	8	0.315	8.0	0.031	0.80	1.18	0.252

Use holders TGB, TGBR/L, TGB-MS, TGER/L, TCER/L, TCFR/L, TTER/L, TTER/L-SH, TGFR/L, TGFPR/L, TGBFR/L, TTFR/L, TTFR/L_RN, TTFPR/L, TTIR/L, see pages 1304 - 1308, 1310, 1314 - 1322, 1324 - 1327.

Part Number	Grade	CT3000	K10	PV3030	TT5100	TT6030	TT7220	TT9030
TDXU3E-0.3		●	●	●	●			●
TDXU4E-0.4		●	●	●	●	●	●	●
TDXU5E-0.4		●	●		●	●		●
TDXU6E-0.4					●	●	●	●
TDXU8E-0.8								●

● = P ● = M ● = K ● = N ● = S ○ = H

PRECISION INSERTS FOR EXTERNAL TURNING AND GROOVING

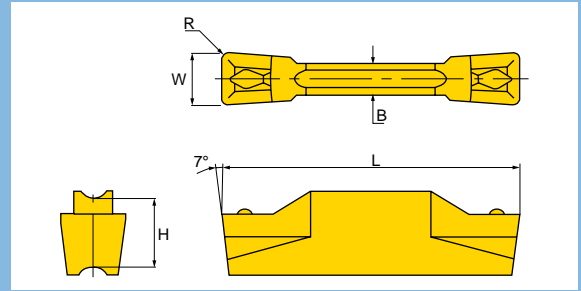

Designation	Insert Seat Size	W ±.0008 (inch)	W ±.02 (mm)	R ±.002 (inch)	L (inch)	H (inch)
TDT3.00E-0.20	3	0.118	3.00	0.008	0.79	0.185
TDT3.00E-0.40	3	0.118	3.00	0.016	0.79	0.185
TDT3.18E-0.18	3	0.125	3.18	0.007	0.79	0.185
TDT3.18E-0.40	3	0.125	3.18	0.016	0.79	0.185
TDT4.00E-0.40	4	0.157	4.00	0.016	0.79	0.185
TDT4.00E-0.80	4	0.157	4.00	0.031	0.79	0.185
TDT4.75E-0.40	5	0.187	4.78	0.016	0.98	0.205
TDT4.78E-0.55	5	0.188	4.78	0.022	0.98	0.205
TDT5.00E-0.40	5	0.197	5.00	0.016	0.98	0.205
TDT5.00E-0.80	5	0.197	5.00	0.031	0.98	0.205
TDT6.00E-0.40	6	0.236	6.00	0.016	0.98	0.205
TDT6.00E-0.80	6	0.236	6.00	0.031	0.98	0.205
TDT6.00E-1.20	6	0.236	6.00	0.047	0.98	0.205
TDT6.35E-0.40	8	0.250	6.35	0.016	1.18	0.252
TDT8.00E-0.80	8	0.315	8.00	0.031	1.18	0.252
TDT8.00E-1.20	8	0.315	8.00	0.047	1.18	0.252

Use holders TGB, TGBR/L, TGB-MS, TGER/L, TCER/L, TCFR/L, TTER/L, TTER/L-SH, TGFR/L, TGFR/L, TGEUR/L, TGBFR/L, TFR/L, TFR/L, TFR/L, TTIR/L, TGIUR/L, see pages 1304 - 1308, 1310, 1314 - 1329.

PRECISION INSERTS FOR EXTERNAL TURNING AND GROOVING

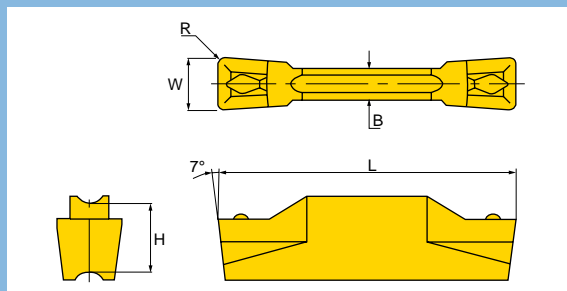

Part Number	Grade	K10	TT5100	TT6030	TT7200	TT7220	TT8020	TT9030		
TDT3.00E-0.20		●	●			●		●		
TDT3.00E-0.40		●	●			●				
TDT3.18E-0.18			●							
TDT3.18E-0.40						●				
TDT4.00E-0.40		●	●			●		●		
TDT4.00E-0.80		●	●			●	●			
TDT4.75E-0.40										
TDT4.78E-0.55			●			●		●		
TDT5.00E-0.40		●	●	●		●				
TDT5.00E-0.80		●	●	●	●	●		●		
TDT6.00E-0.40				●						
TDT6.00E-0.80		●	●			●		●		
TDT6.00E-1.20		●	●			●				
TDT6.35E-0.40						●				
TDT8.00E-0.80		●	●			●				
TDT8.00E-1.20		●	●			●		●		

● = P ● = M ● = K ● = N ● = S ○ = H



TOCLAMP^{ULTRA+} TDT-E

PRESSED INSERTS FOR EXTERNAL TURNING AND GROOVING

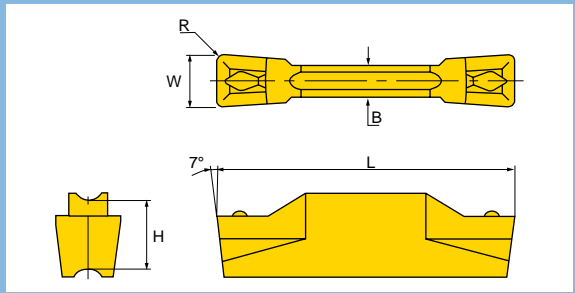

Designation	Insert Seat Size	W ±.05 (mm)	W ±.002 (inch)	R (inch)	L (inch)	H (inch)
TDT3E-0.4	3	3.0	0.118	0.016	0.79	0.185
TDT4E-0.4	4	4.0	0.157	0.016	0.79	0.185

Use holders TGB, TGBR/L, TGB-MS, TGER/L, TCER/L, TCFR/L, TTER/L, TTER/L-SH, TGFR/L, TGFPR/L, TGEUR/L, TGBFR/L, TFR/L, TFR/L, TFRPR/L, TTIR/L, TGIUR/L, see pages 1304 - 1308, 1310, 1314 - 1329.

Part Number	Grade						
	CT3000	K10	TT5100	TT7220			
TDT3E-0.4							
TDT4E-0.4							

● = P ● = M ● = K ● = N ● = S ○ = H

TOCLAMP^{ULTRA+} TDT-E CE

PRESSED CERAMIC INSERTS FOR EXTERNAL TURNING AND GROOVING

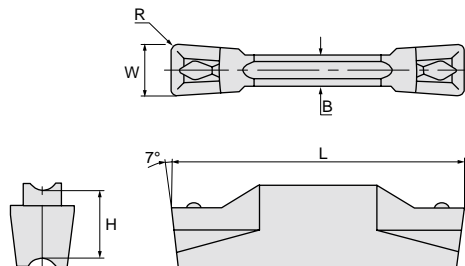

Designation	Insert Seat Size	W ±.05 (mm)	W ±.002 (inch)	R (inch)	L (inch)	H (inch)	Grade	AB30				
TDT4E-0.4TCE	4	4.0	0.157	0.016	0.79	0.185						
TDT6E-0.8TCE	6	6.0	0.236	0.031	0.98	0.205						

Use holders TGB, TGBR/L, TGB-MS, TGER/L, TCER/L, TCFR/L, TTER/L, TTER/L-SH, TGFR/L, TGFPR/L, TGEUR/L, TGBFR/L, TTFR/L, TTFR/L, TTFPR/L, TTIR/L, TGIUR/L, see pages 1304 - 1308, 1310, 1314 - 1329.

● = P ● = M ● = K ● = N ● = S ○ = H

TOCLAMP^{ULTRA+} TDT-RU (FULL RADIUS)

FULL RADIUS PRESSED INSERTS FOR TURNING, GROOVING AND PROFILING

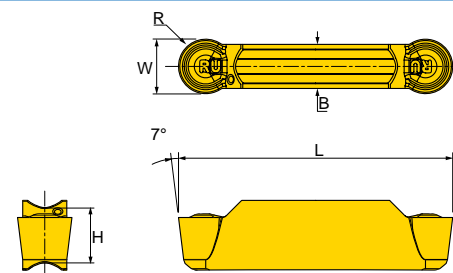

Designation	Insert Seat Size	W ±.05 (mm)	W ±.002 (inch)	R (inch)	L (inch)	H (inch)	Grade	CT3000	PV3030	TT5100	TT9030
TDT3E-1.5RU	3	3.0	0.118	0.059	0.79	0.185					
TDT4E-2.0RU	4	4.0	0.157	0.079	0.79	0.185					
TDT5E-2.5RU	5	5.0	0.197	0.098	0.98	0.205					
TDT6E-3.0RU	6	6.0	0.236	0.118	0.98	0.205					
TDT8E-4.0RU	8	8.0	0.315	0.157	1.18	0.252					

Use holders TGB, TGBR/L, TGB-MS, TGER/L, TCER/L, TCFR/L, TTER/L, TTER/L-SH, TGFR/L, TGFPR/L, TGEUR/L, TGBFR/L, TTFR/L, TTFR/L, TTFPR/L, TTIR/L, TGIUR/L, see pages 1304 - 1308, 1310, 1314 - 1329.

● = P ● = M ● = K ● = N ● = S ○ = H

TOCLAMP^{ULTRA+} TDT-E (FULL RADIUS)

FULL RADIUS PRECISION INSERTS FOR EXTERNAL TURNING, GROOVING AND PROFILING

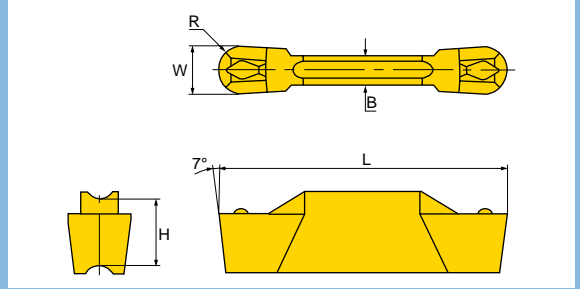

Designation	Insert Seat Size	W ±.02 (mm)	W ±.0008 (inch)	R ±.002 (inch)	L (inch)	H (inch)
TDT3.00E-1.50	3	3.00	0.118	0.059	0.79	0.185
TDT4.00E-2.00	4	4.00	0.157	0.079	0.79	0.185
TDT4.78E-2.39	5	4.78	0.188	0.094	0.98	0.205
TDT5.00E-2.50	5	5.00	0.197	0.098	0.98	0.205
TDT6.00E-3.00	6	6.00	0.236	0.118	0.98	0.205
TDT8.00E-4.00	8	8.00	0.315	0.157	1.18	0.252

Use holders TGB, TGBR/L, TGB-MS, TGER/L, TCER/L, TCFR/L, TTER/L, TTER/L-SH, TGFR/L, TGFR/L, TGFPR/L, TGEUR/L, TGBFR/L, TTFR/L, TTFR/L, TTFR/L, TTIR/L, TGIUR/L, see pages 1304 - 1308, 1310, 1314 - 1329.

Part Number	Grade									
	K10	TT5100	TT7220	TT8020	TT9030					
TDT3.00E-1.50	●	●	●		●					
TDT4.00E-2.00	●	●	●	●	●					
TDT4.78E-2.39	●	●	●							
TDT5.00E-2.50	●	●	●							
TDT6.00E-3.00	●	●	●							
TDT8.00E-4.00		●								

● = P ● = M ● = K ● = N ● = S ○ = H

TOCLAMP^{ULTRA+} TDFT-E

PRESSED INSERTS FOR FACE GROOVING AND TURNING

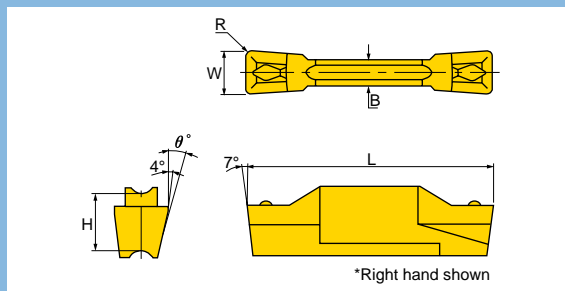
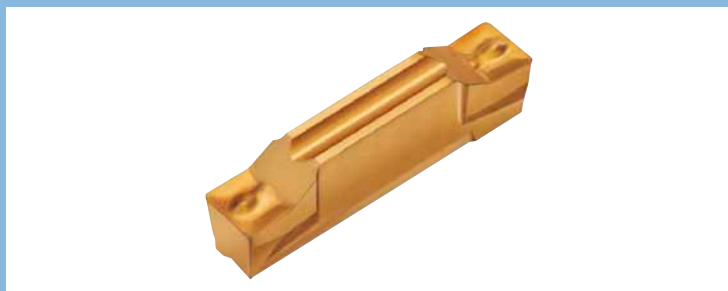

Designation	Insert Seat Size	W ±.05 (mm)	W ±.002 (inch)	R (inch)	L (inch)	H (inch)	Grade	K10	TT5100	TT7200	TT7220
TDFT3E-0.4L	3	3.00	0.118	0.016	0.79	0.185					
TDFT3E-0.4R	3	3.00	0.118	0.016	0.79	0.185					
TDFT4E-0.4L	4	4.00	0.157	0.016	0.79	0.185					
TDFT4E-0.4R	4	4.00	0.157	0.016	0.79	0.185					

Use holders TGBFR/L, TCFR/L, TGFR/L, TGFPR/L, TFR/L, TFR/L_RN, TTFPR/L, see pages 1307, 1315, 1316, 1322, 1324 - 1326.

= P = M = K = N = S = H

TOCLAMP^{ULTRA+} TDFT-E CE

PRESSED CERAMIC INSERTS FOR FACE GROOVING AND TURNING

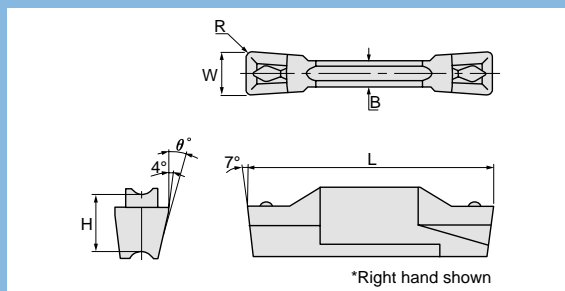
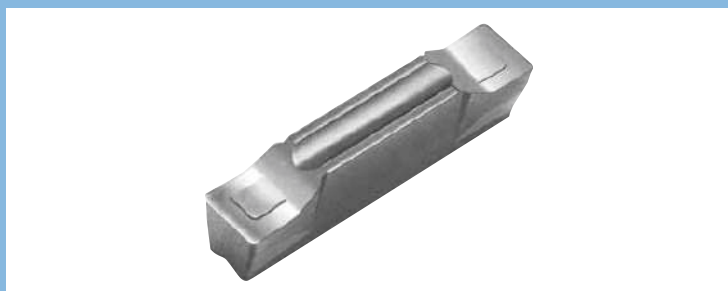

Designation	Insert Seat Size	W ±.05 (mm)	W ±.002 (inch)	R (inch)	L (inch)	H (inch)	Grade	AB30			
TDFT4E-0.4TLCE	4	4.00	0.157	0.016	0.79	0.185					
TDFT4E-0.4TRCE	4	4.00	0.157	0.016	0.79	0.185					

Use holders TGBFR/L, TCFR/L, TGFR/L, TGFPR/L, TFR/L, TFR/L_RN, TTFPR/L, see pages 1307, 1315, 1316, 1322, 1324 - 1326.

= P = M = K = N = S = H

PRECISION INSERTS FOR EXTERNAL GROOVING ONLY



OD Grooving

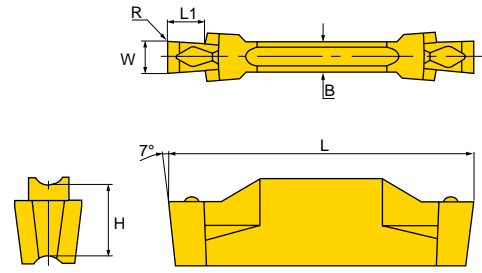

Designation	Insert Seat Size	W ±.02 (mm)	W ±.0008 (inch)	R ±.0012 (Inch)	L (inch)	L1 (inch)	H (inch)
TDT1.00-0.00	2	1.00	0.039	-	0.79	0.098	0.185
TDT1.30-0.00	2	1.30	0.051	-	0.79	0.098	0.185
TDT1.60-0.10	2	1.60	0.063	0.004	0.79	0.098	0.185
TDT1.85-0.10	2	1.85	0.073	0.004	0.79	0.138	0.185
TDT2.15-0.15	2	2.15	0.085	0.006	0.79	0.138	0.185
TDT2.39-0.18	3	2.39	0.094	0.007	0.79	0.197	0.185
TDT2.65-0.15	3	2.65	0.104	0.006	0.79	0.197	0.185
TDT3.15-0.15	3	3.15	0.124	0.006	0.79	0.197	0.185
TDT4.15-0.15	4	4.15	0.163	0.006	0.79	0.197	0.185
TDT5.15-0.15	5	5.15	0.203	0.006	0.98	0.197	0.205

Use holders TGB, TGBR/L, TGB-MS, TGER/L, TCFR/L, TCFR/L, TTER/L, TTER/L-SH, TGFR/L, TGFR/L, TGEUR/L, TGBFR/L, TTFR/L, TTFR/L, TTFR/L, TTIR/L, TGIUR/L, [pages 1304 - 1308, 1310, 1314 - 1329.](#)

Part Number	Grade	K10	TT5100	TT7200	TT7220	TT9030				
TDT1.00-0.00		●	●		●					
TDT1.30-0.00		●	●		●					
TDT1.60-0.10		●	●		●	●				
TDT1.85-0.10		●	●	●	●					
TDT2.15-0.15		●	●		●	●				
TDT2.39-0.18					●					
TDT2.65-0.15		●	●		●					
TDT3.15-0.15		●	●		●					
TDT4.15-0.15		●	●		●					
TDT5.15-0.15		●			●					

● = P ● = M ● = K ● = N ● = S ○ = H

TOCLAMP^{ULTRA+} TDIT-.00E

PRECISION INSERTS FOR INTERNAL TURNING AND GROOVING

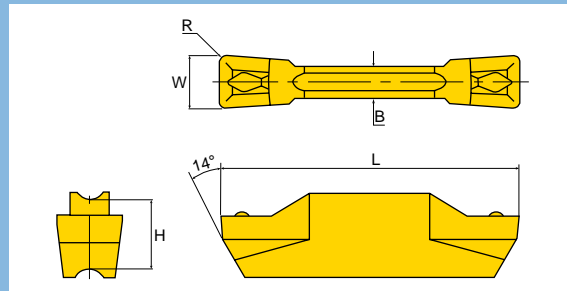

Designation	Insert Seat Size	W ±.02 (mm)	W ±.0008 (inch)	R ±.002 (Inch)	L (inch)	H (inch)	Grade	K10	TT5100	TT7200	TT7220
TDIT3.00E-0.40	3	3.00	0.118	0.016	0.79	0.185		●	●		●
TDIT4.00E-0.40	4	4.00	0.157	0.016	0.79	0.185		●	●		●
TDIT4.00E-0.80	4	4.00	0.157	0.031	0.79	0.185		●	●		●
TDIT5.00E-0.40	5	5.00	0.197	0.016	0.98	0.205		●	●		●
TDIT5.00E-0.80	5	5.00	0.197	0.031	0.98	0.205		●	●		●
TDIT6.00E-0.80	6	6.00	0.236	0.031	0.98	0.205		●	●	●	●
TDIT6.00E-1.20	6	6.00	0.236	0.047	0.98	0.205		●	●	●	●
TDIT8.00E-0.80	8	8.00	0.315	0.031	1.18	0.252		●	●	●	●
TDIT8.00E-1.20	8	8.00	0.315	0.047	1.18	0.252		●	●	●	●

Use holders TGEUR/L, TTIR/L, TGIUR/L, see pages 1323, 1327 - 1329.

● = P ● = M ● = K ● = N ● = S ○ = H

TOCLAMP^{ULTRA+} TDIT-E

PRESSED INSERTS FOR INTERNAL TURNING AND GROOVING

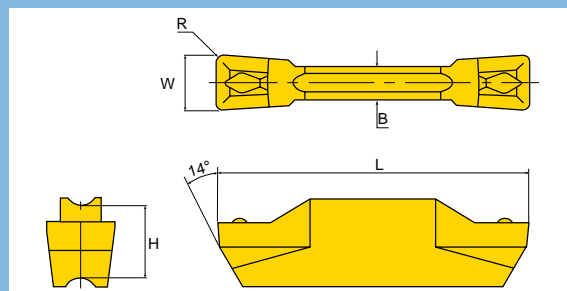

Designation	Insert Seat Size	W ±.05 (mm)	W ±.002 (inch)	R (Inch)	L (inch)	H (inch)	Grade	TT5100			
TDIT3E-0.4	3	3.00	0.118	0.016	0.79	0.185		●			
TDIT4E-0.4	4	4.00	0.157	0.016	0.79	0.185		●			

Use holders TGEUR/L, TTIR/L, TGIUR/L, see pages 1323, 1327 - 1329.

● = P ● = M ● = K ● = N ● = S ○ = H

TOCLAMP^{ULTRA+} TDIT-E CE

PRESSED CERAMIC INSERTS FOR INTERNAL TURNING AND GROOVING

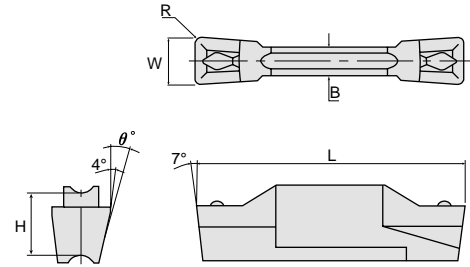

Designation	Insert Seat Size	W ±.05 (mm)	W ±.002 (inch)	R (inch)	L (inch)	H (inch)	Grade	AB30			
TDIT4E-0.4TCE	4	4.00	0.157	0.016	0.79	0.185					
TDIT6E-0.8TCE	6	6.00	0.236	0.031	0.98	0.205					

Use holders TGEUR/L, TTIR/L, TGIUR/L, see pages 1323, 1327 - 1329.

● = P ● = M ● = K ● = N ● = S ○ = H

TOCLAMP^{ULTRA+} TDIT-E (FULL RADIUS)

FULL RADIUS PRECISION INSERTS FOR INTERNAL TURNING, GROOVING AND PROFILING

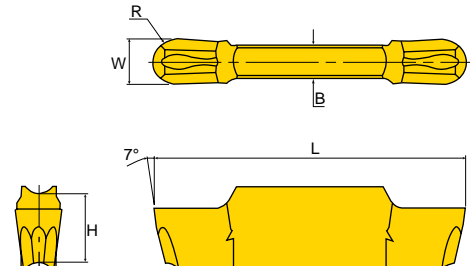

Designation	Insert Seat Size	W ±.02 (mm)	W ±.008 (inch)	R ±.002 (inch)	L (inch)	H (inch)	Grade	K10	TT5100	TT7220
TDIT3.00E-1.50	3	3.00	0.118	0.059	0.79	0.185				
TDIT4.00E-2.00	4	4.00	0.157	0.079	0.79	0.185				
TDIT5.00E-2.50	5	5.00	0.197	0.098	0.98	0.205				
TDIT6.00E-3.00	6	6.00	0.236	0.236	0.98	0.205				

Use holders TGEUR/L, TTIR/L, TGIUR/L, see pages 1323, 1327 - 1329.

● = P ● = M ● = K ● = N ● = S ○ = H

TOCLAMP^{ULTRA+} TDA

FULL RADIUS PRECISION INSERTS FOR ALUMINUM MACHINING



ID Undercutting



OD Turning



OD Profiling

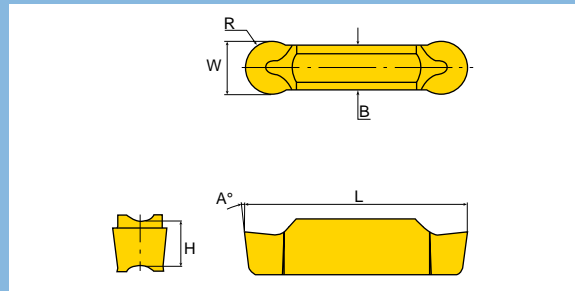

Designation	Insert Seat Size	W ±.02 (mm)	W ±.0008 (inch)	R ±.002 (inch)	L (inch)	H (inch)	A (degree)	Grade	K10			
TDA6.00-3.00	6	6.00	0.236	0.118	0.98	0.205	7		●			
TDA8.00-4.00	8	8.00	0.315	0.157	1.18	0.252	10		●			

Use holders TTER/L, TGIUR/L, TTER/L-15A, see pages 1317, 1328 - 1330.

● = P ● = M ● = K ● = N ● = S ○ = H

TOCLAMP^{ULTRA+} TSA

PCD TIPPED INSERTS FOR ALUMINUM WHEEL MACHINING



ID Undercutting



OD Turning



OD Profiling

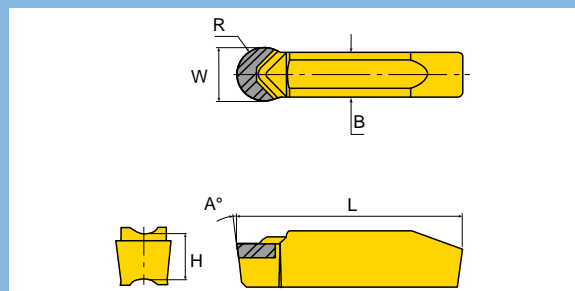

Designation	Insert Seat Size	W ±.02 (mm)	W ±.0008 (inch)	R ±.002 (inch)	L (inch)	H (inch)	A (degree)	Grade	KP300			
TSA6.00-3.00	6	6.00	0.236	0.118	0.98	0.205	7		●			
TSA8.00-4.00	8	8.00	0.315	0.157	1.18	0.252	10		●			

Use holders TTER/L, TGIUR/L, TTER/L-15A, see pages 1317, 1328 - 1330.

● = P ● = M ● = K ● = N ● = S ○ = H

T-CLAMP ULTRA INSERTS FOR PARTING AND GROOVING, "C" TYPE CHIPBREAKERS

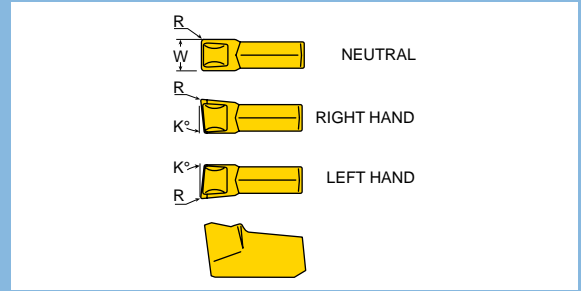

Designation	Hand	Insert Seat Size	W ±.1 (mm)	W ±.004 (inch)	K (degrees)	R (inch)
TIMC2.46L	Left	2	2.4	0.094	6	0.008
TIMC36L	Left	4	3.1	0.122	6	0.008
TIMC46L	Left	4	4.1	0.161	6	0.010
TIMC4.86L	Left	4	4.8	0.189	6	0.011
TIMC56L	Left	4	5.1	0.200	6	0.012
TIMC66L	Left	6	6.4	0.250	6	0.014
TIMC1.6	Neutral	1	1.6	0.063	-	0.006
TIMC2	Neutral	2	2.2	0.087	-	0.008
TIMC2.4	Neutral	2	2.4	0.094	-	0.008
TIMC3	Neutral	4	3.1	0.122	-	0.008
TIMC4	Neutral	4	4.1	0.161	-	0.010
TIMC4.8	Neutral	4	4.8	0.189	-	0.011
TIMC5	Neutral	4	5.1	0.200	-	0.012
TIMC6	Neutral	6	6.4	0.250	-	0.014
TIMC1.66R	Right	1	1.6	0.063	6	0.006
TIMC26R	Right	2	2.2	0.087	6	0.008
TIMC2.46R	Right	2	2.4	0.094	6	0.008
TIMC36R	Right	4	3.1	0.122	6	0.008
TIMC46R	Right	4	4.1	0.161	6	0.010
TIMC4.86R	Right	4	4.8	0.189	6	0.011
TIMC56R	Right	4	5.1	0.200	6	0.012
TIMC66R	Right	6	6.4	0.250	6	0.014

Use holders TH101, THR/L201, THR/L211, THR/L619, see [pages 1331 - 1336](#).

**T-CLAMP ULTRA INSERTS FOR PARTING AND GROOVING,
"C" TYPE CHIPBREAKERS**



OD Grooving



Parting

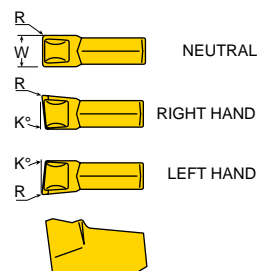

Part Number	Grade	K10	P40A	TT5100	TT6030	TT7200	TT7220	TT8020	TT9030
TIMC2.46L		●			●		●		
TIMC36L		●		●	●		●	●	
TIMC46L		●		●	●				
TIMC4.86L		●		●	●				
TIMC56L		●			●		●		
TIMC66L		●		●	●				
TIMC1.6		●			●		●	●	●
TIMC2				●	●	●	●	●	●
TIMC2.4					●		●	●	●
TIMC3		●	●	●	●		●	●	●
TIMC4		●		●	●		●	●	●
TIMC4.8		●		●	●			●	
TIMC5					●		●	●	
TIMC6		●		●	●			●	
TIMC1.66R		●			●		●		
TIMC26R		●		●	●		●		
TIMC2.46R		●			●		●		
TIMC36R		●	●	●	●		●	●	
TIMC46R		●		●	●		●	●	
TIMC4.86R		●		●	●			●	
TIMC56R		●			●		●		
TIMC66R		●		●	●				

● = P ● = M ● = K ● = N ● = S ○ = H

T-CLAMP ULTRA INSERTS FOR PARTING AND GROOVING, "J" TYPE CHIPBREAKERS

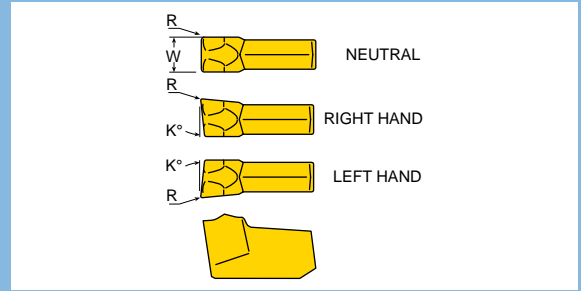

Designation	Hand	Insert Seat Size	W ±.1 (mm)	W ±.004 (inch)	K (degrees)	R (inch)	Grade	K10	TT5100	TT6030	TT8020
TIMJ26L	Left	2	2.2	0.087	6	0.008	●●●●●●	●		●	
TIMJ2.46L	Left	2	2.4	0.094	6	0.008	●●●●●●			●	
TIMJ36L	Left	4	3.1	0.122	6	0.008	●●●●●●	●	●	●	
TIMJ46L	Left	4	4.1	0.161	6	0.010	●●●●●●	●	●	●	
TIMJ4.86L	Left	4	4.8	0.189	6	0.011	●●●●●●	●	●	●	
TIMJ56L	Left	4	5.1	0.200	6	0.012	●●●●●●	●	●	●	
TIMJ2	Neutral	2	2.2	0.087	-	0.008	●●●●●●	●	●	●	
TIMJ2.4	Neutral	2	2.4	0.094	-	0.008	●●●●●●	●	●	●	
TIMJ3	Neutral	4	3.1	0.122	-	0.008	●●●●●●	●	●	●	●
TIMJ4	Neutral	4	4.1	0.161	-	0.010	●●●●●●	●	●	●	●
TIMJ4.8	Neutral	4	4.8	0.189	-	0.011	●●●●●●	●	●	●	●
TIMJ5	Neutral	4	5.1	0.200	-	0.012	●●●●●●	●	●	●	●
TIMJ26R	Right	2	2.2	0.087	6	0.008	●●●●●●	●	●	●	
TIMJ2.46R	Right	2	2.4	0.094	6	0.008	●●●●●●	●	●	●	
TIMJ36R	Right	4	3.1	0.122	6	0.008	●●●●●●		●	●	●
TIMJ46R	Right	4	4.1	0.161	6	0.010	●●●●●●	●	●	●	●
TIMJ4.86R	Right	4	4.8	0.189	6	0.011	●●●●●●	●	●	●	●
TIMJ56R	Right	4	5.1	0.200	6	0.012	●●●●●●	●	●	●	●

Use holders TH101, THR/L201, THR/L211, THR/L619, see pages 1331 - 1336.

● = P ● = M ● = K ● = N ● = S ○ = H

T-CLAMP ULTRA INSERTS FOR PRECISION TURNING AND GROOVING, "V" TYPE CHIPBREAKERS



OD Groove Turn



OD Grooving



OD Profiling

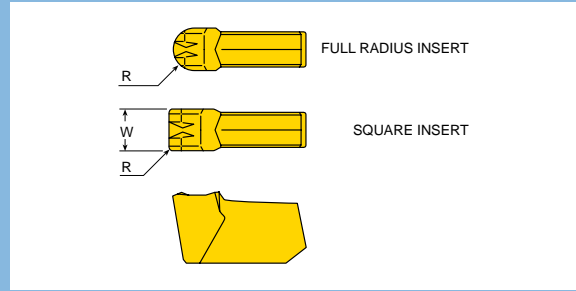
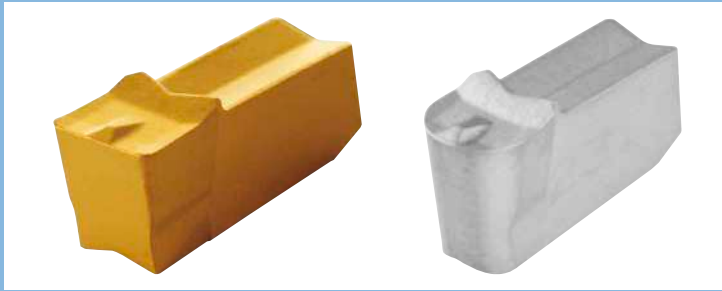

Designation	Insert Seat Size	W ±.02 (mm)	W ±.0008 (inch)	R (inch)	Grate				
						K10	TT5100	TT6030	TT8020
TIPV3.00E0.40	4	3.00	0.118	0.016		●	●	●	
TIPV3.00E1.50*	4	3.00	0.118	0.059		●	●	●	
TIPV4.00E0.40	4	4.00	0.157	0.016		●	●	●	●
TIPV4.00E2.00*	4	4.00	0.157	0.079		●	●	●	
TIPV4.50E0.40	4	4.50	0.177	0.016		●	●	●	
TIPV5.00E0.40	4	5.00	0.197	0.016		●	●	●	
TIPV5.00E2.50*	4	5.00	0.197	0.098		●	●	●	
TIPV6.00E0.40	4	6.00	0.236	0.016		●	●	●	
TIPV6.00E3.00*	6	6.00	0.236	0.118		●	●	●	

* R = 1/2w for radius inserts.

Use holders TH101, THR/L201, THR/L211, THR/L619, see [pages 1331 - 1336](#).

● = P ● = M ● = K ● = N ● = S ○ = H

T-CLAMP ULTRA INSERTS FOR PRECISION TURNING, GROOVING AND PROFILING, "V" TYPE CHIPBREAKERS

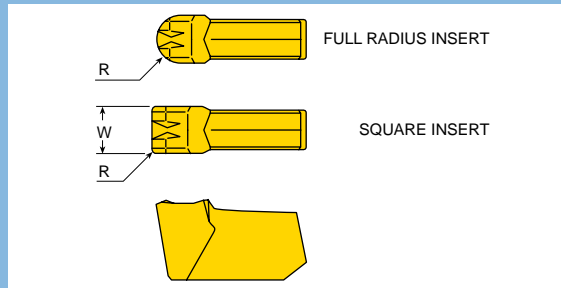
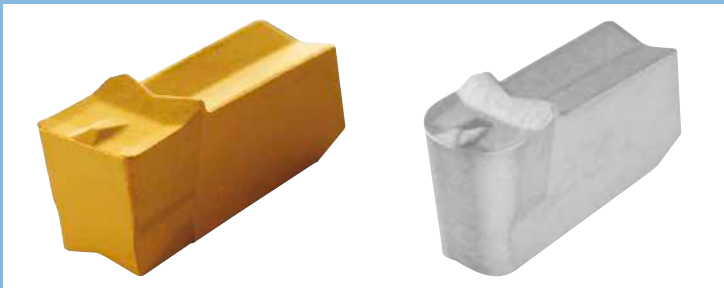

Designation	Insert Seat Size	W ±.02 (mm)	W ±.0008 (inch)	R (inch)	Grade	K10	TT5100	TT6030		
TIPV.090E.007	2	2.29	0.090	0.007						
TIPV.130E.007	4	3.30	0.130	0.007						
TIPV.130E.065	4	3.30	0.130	0.065						
TIPV.170E.015	4	4.32	0.170	0.015						
TIPV.170E.085	4	4.32	0.170	0.085						
TIPV.210E.024	4	5.33	0.210	0.024						
TIPV.210E.105	4	5.33	0.210	0.105						
TIPV.255E.024	6	6.48	0.255	0.024						
TIPV.255E.127	6	6.48	0.255	0.127						

Use holders TH101, THR/L201, THR/L211, THR/L619, see pages 1331 - 1336.

● = P ● = M ● = K ● = N ● = S ○ = H

T-CLAMP ULTRA INSERTS FOR PRECISION TURNING AND GROOVING, "V" TYPE CHIPBREAKERS

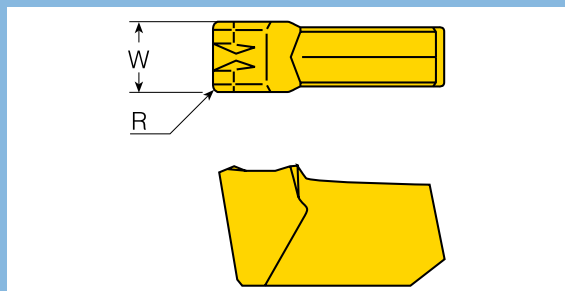

Designation	Insert Seat Size	W ±.02 (mm)	W ±.0008 (inch)	R (inch)	Grade	K10	TT5100	TT6030	TT8020
TIPV1.850.10	2	1.85	0.073	0.004		●	●	●	
TIPV.078.007	2	1.98	0.078	0.007		●	●	●	
TIPV2.000.20	2	2.00	0.079	0.008		●	●	●	
TIPV2.150.15	2	2.15	0.085	0.006		●	●	●	
TIPV.088.007	2	2.24	0.088	0.007		●	●		
TIPV.094.007	2	2.39	0.094	0.007			●	●	
TIPV.097.013	2	2.46	0.097	0.013		●	●		
TIPV2.650.15	4	2.65	0.104	0.006		●	●	●	
TIPV.105.007	4	2.67	0.105	0.007		●	●	●	
TIPV.110.013	4	2.79	0.110	0.013			●		
TIPV3.000.20	4	3.00	0.118	0.008		●	●	●	
TIPV.122.007	4	3.10	0.122	0.007		●	●	●	
TIPV.125.007	4	3.18	0.125	0.007		●	●	●	
TIPV3.180.20	4	3.18	0.125	0.008		●	●	●	
TIPV.142.013	4	3.61	0.142	0.130			●	●	
TIPV.156.007	4	3.96	0.156	0.007		●	●	●	
TIPV4.000.20	4	4.00	0.157	0.008		●	●	●	
TIPV4.150.15	4	4.15	0.163	0.006			●	●	
TIPV.178.007	4	4.52	0.178	0.007		●	●	●	
TIPV.185.022	4	4.70	0.185	0.022		●	●	●	
TIPV.189.022	4	4.80	0.189	0.022		●	●	●	●
TIPV5.000.20	4	5.00	0.197	0.008			●	●	
TIPV5.150.15	4	5.15	0.203	0.006		●	●	●	
TIPV.213.007	4	5.41	0.213	0.007		●	●	●	
TIPV.219.022	6	5.56	0.219	0.022		●	●		
TIPV6.000.20	6	6.00	0.236	0.008		●	●	●	
TIPV.250.022	6	6.35	0.250	0.022		●	●	●	●

Use holders TH101, THR/L201, THR/L211, THR/L619, see pages 1331 - 1336.

● = P ● = M ● = K ● = N ● = S ○ = H

GENERAL TECHNICAL INFORMATION

TOCLAMP^{ULTRA} BLADE & HOLDER DESIGNATION SYSTEM







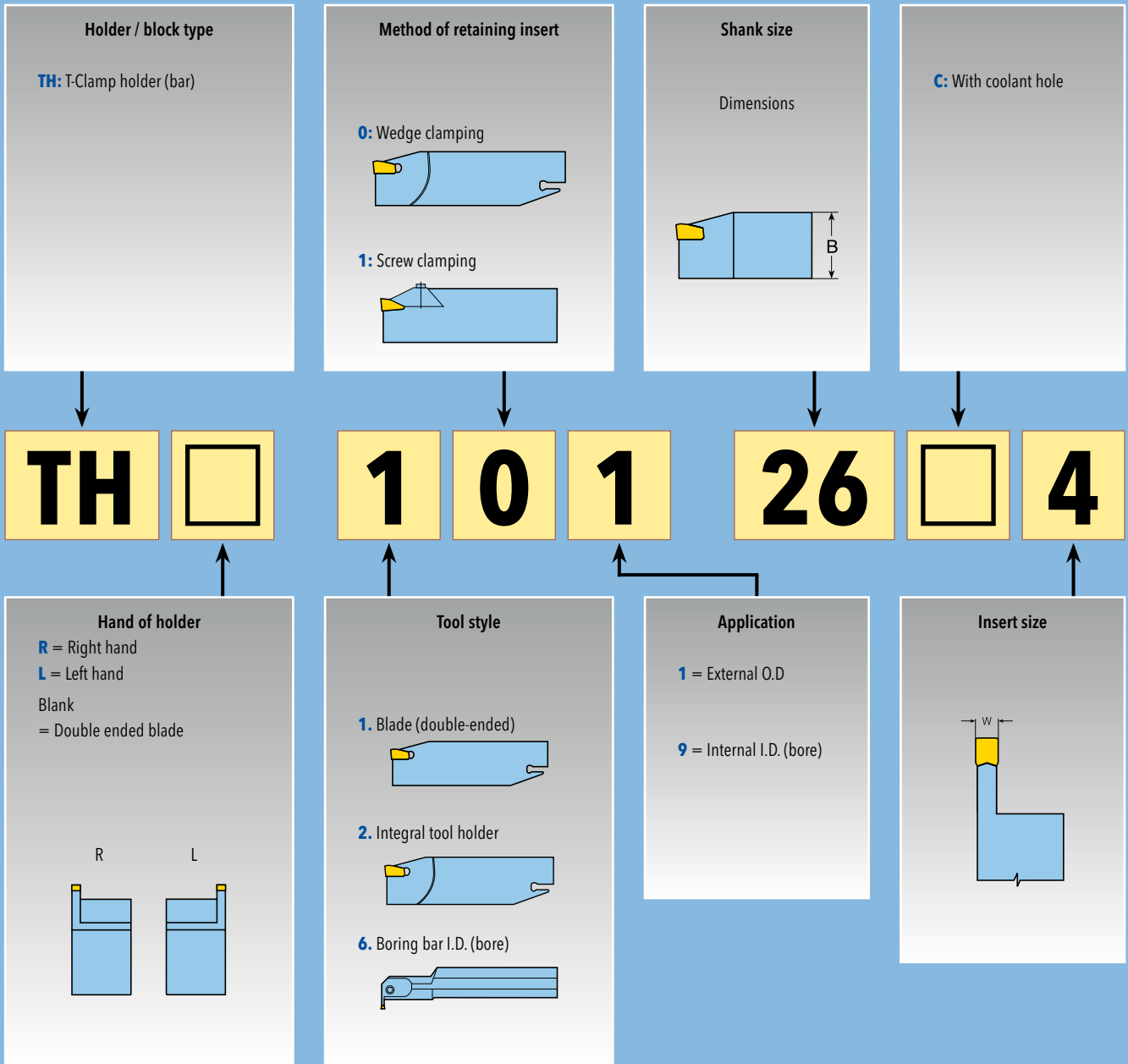







GENERAL TECHNICAL INFORMATION

TOCLAMP^{ULTRA} BLADE & HOLDER DESIGNATION SYSTEM











T-CLAMP HOLDER.

Designation	Description	Page
 <p>T-CLAMP^{ULTRA+} TGB 26</p>	Blades for parting and deep grooving	1304
 <p>T-CLAMP^{ULTRA+} TGB 32</p>	Blades for parting and deep grooving	1304
 <p>T-CLAMP^{ULTRA+} TGB 32_CL</p>	Blades for parting and deep grooving	1305
 <p>T-CLAMP^{ULTRA+} TGB 45</p>	Blades for parting and deep grooving	1305
 <p>T-CLAMP^{ULTRA+} TGB 52_CL</p>	Blades for parting and deep grooving	1306
 <p>T-CLAMP^{ULTRA+} TGBR/L</p>	Blades for parting and deep grooving	1306
 <p>T-CLAMP^{ULTRA+} TGBFR/L</p>	Deep face grooving blades	1307
 <p>T-CLAMP^{ULTRA+} TGB-MS</p>	Blades for multi-spindle machines Replacement for HSS and brazed tools	1308
 <p>T-CLAMP^{ULTRA+} TTBN</p>	Blocks for parting and deep grooving blades	1309
 <p>T-CLAMP^{ULTRA+} TTBU</p>	Blocks for parting and deep grooving blades	1309
 <p>T-CLAMP^{ULTRA+} TGER/L</p>	Holders for parting and deep grooving	1310
 <p>T-CLAMP^{ULTRA+} TCHR/L</p>	Parallel holders for modular blades	1311

	Designation	Description	Page
	TOCLAMP^{ULTRA+} TCHPR/L	Perpendicular holders for modular blades	1312
	TOCLAMP^{ULTRA+} TCHN CAPTO	Adapter for external turning and grooving (left hand or right hand)	1313
	TOCLAMP^{ULTRA+} TCHPN CAPTO	Adapter for external turning and grooving (left hand or right hand)	1313
	TOCLAMP^{ULTRA+} TCEL	Adapter for external turning and grooving (left hand)	1314
	TOCLAMP^{ULTRA+} TCER	Adapter for external turning and grooving (right hand)	1314
	TOCLAMP^{ULTRA+} TCFR	Adapter for external face grooving and turning (right hand)	1315
	TOCLAMP^{ULTRA+} TCFL	Adapter for external face grooving and turning (left hand)	1316
	TOCLAMP^{ULTRA+} TTER/L short	Short T-Max holders for external turning and grooving	1317
	TOCLAMP^{ULTRA+} TTER/L	Middle T-Max holders for external turning and grooving	1318
	TOCLAMP^{ULTRA+} TTER/L long	Long T-Max holders for external turning and grooving	1319
	TOCLAMP^{ULTRA+} TTER/L-SH	External turning and grooving holders for Swiss automatics	1320
	TOCLAMP^{ULTRA+} TGER/L	External holders for shallow face precision grooving and face turning	1322

T-CLAMP HOLDER.

Designation	Description	Page	
	T-CLAMP^{ULTRA+} TGFPRL	External holders for shallow face perpendicular grooving and face turning	1322
	T-CLAMP^{ULTRA+} TGEURL	External undercutting holders	1323
	T-CLAMP^{ULTRA+} TTFR/L	Deep face grooving and turning holders	1324
	T-CLAMP^{ULTRA+} TTFR/L-RN	Deep face grooving and turning holders (Renewed type)	1325
	T-CLAMP^{ULTRA+} TTFPRL	Deep face grooving and turning perpendicular holders against center	1326
	T-CLAMP^{ULTRA+} TTIR/L	Internal turning, grooving and profiling holders	1327
	T-CLAMP^{ULTRA+} TGIURL	Internal undercutting holders	1328
	T-CLAMP^{ULTRA+} TGIURL	Internal turning holders	1328
	T-CLAMP^{ULTRA+} TGIURL	Internal turning holders with coolant - Metric	1329
	T-CLAMP^{ULTRA+} TTER/L	Internal turning holders for aluminum wheels machining	1330
	T-CLAMP^{ULTRA} TH101	T-Clamp Ultra blades for parting and grooving	1331
	T-CLAMP^{ULTRA} THR/L201	T-Clamp Ultra tool holders for parting and grooving	1332

	Designation	Description	Page
	TOCLAMP THR/L211	T-Clamp Ultra tool holders for turning and grooving	1334
	TOCLAMP ^{ULTRA} THR/L619	T-Clamp Ultra tool holders for ID Turning and grooving	1336
	TOCLAMP TTG (Lever Lock)	Triple corner insert for shallow grooving	1338
	TOCLAMP TTG (Screw Clamp)	Triple corner insert for shallow grooving	1339
	TOCLAMP TGTER/L (Lever Lock)	External shallow grooving holders	1340
	TOCLAMP TGTER/L (Screw Clamp)	External shallow grooving holders	1341
	TOCLAMP TGDIR/L	Internal shallow grooving holders	1342

TOCLAMP^{ULTRA+} TGB 26

BLADES FOR PARTING AND DEEP GROOVING





OD Grooving

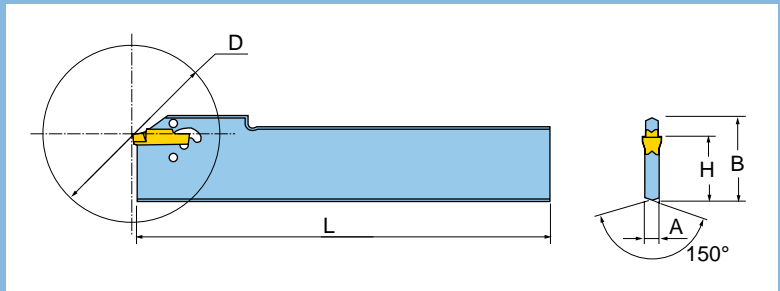

Parting



Designation	Insert Seat Size	H (inch)	B (inch)	L (inch)	A (inch)	Dmax (inch)			
							Insert Extractor	Block	Block
TGB26-1.4S	1	0.84	1.02	5.90	0.039	1.02	EDG-23B	TTBU_-26	TTBN_-26
TGB26-2S	2	0.84	1.02	5.90	0.071	1.57	EDG-33B	TTBU_-26	TTBN_-26
TGB26-3S	3	0.84	1.02	5.90	0.094	1.97	EDG-33B	TTBU_-26	TTBN_-26
TGB26-4S	4	0.84	1.02	5.90	0.126	3.15	EDG-33B	TTBU_-26	TTBN_-26

Use inserts TDC/TSC, TDJ/TSJ, TDUX, TDT, see [pages 1274 - 1288](#).

TOCLAMP^{ULTRA+} TGB 32

BLADES FOR PARTING AND DEEP GROOVING





OD Grooving

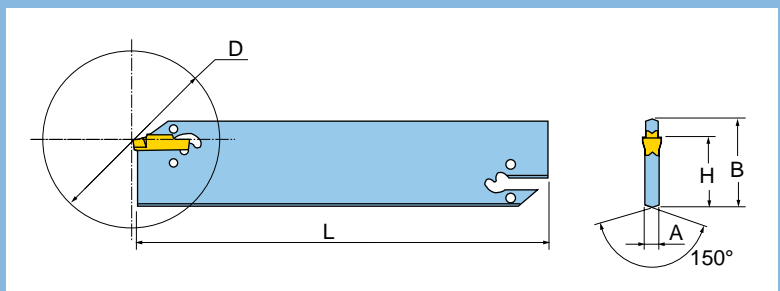
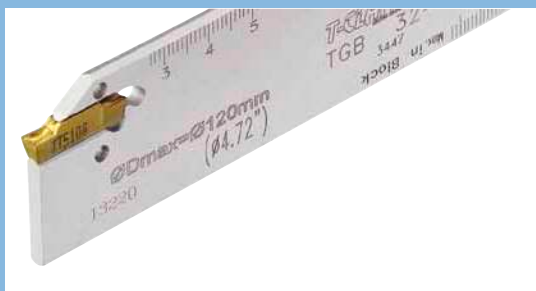

Parting







Designation	Insert Seat Size	H (inch)	B (inch)	L (inch)	A (inch)	Dmax (inch)			
							Insert Extractor	Block	Block
TGB32-1.4	1	0.98	1.26	5.90	0.039	0.98	EDG-33B	TTBU_-32	TTBN_-32
TGB32-2	2	0.98	1.26	5.90	0.071	1.97	EDG-33B	TTBU_-32	TTBN_-32
TGB32-3	3	0.98	1.26	5.90	0.094	3.94	EDG-33B	TTBU_-32	TTBN_-32
TGB32-4	4	0.98	1.26	5.90	0.126	3.94	EDG-33B	TTBU_-32	TTBN_-32
TGB32-5	5	0.98	1.26	5.90	0.157	4.72	EDG-33B	TTBU_-32	TTBN_-32
TGB32-6	6	0.98	1.26	5.90	0.205	4.72	EDG-33B	TTBU_-32	TTBN_-32

Use inserts TDC/TSC, TDJ/TSJ, TDUX, TDT, see [pages 1274 - 1288](#).

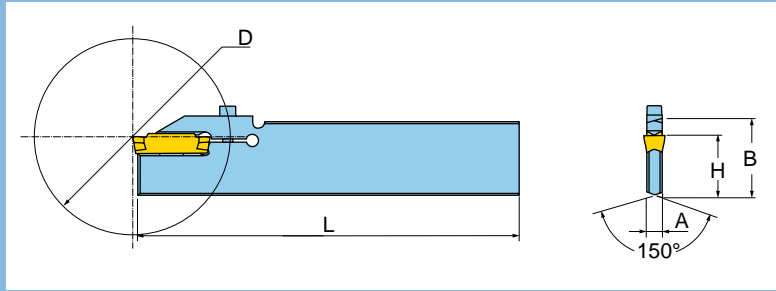
TOCLAMP^{ULTRA+}™ TGB 32 CL

BLADES FOR PARTING AND DEEP GROOVING





Designation	Insert Seat Size	H (inch)	B (inch)	L (inch)	A (inch)	Dmax (inch)				
TGB32-85-CL	8	0.98	1.26	5.90	0.244	3.15	TTBU_-32	TTBN_-32	SHM4X0.7X20-MO	L-W3

Use inserts TDC/TSC, TDJ/TSJ, TDUX, TDT, see pages 1274 - 1288.

TOCLAMP^{ULTRA+}™ TGB 45

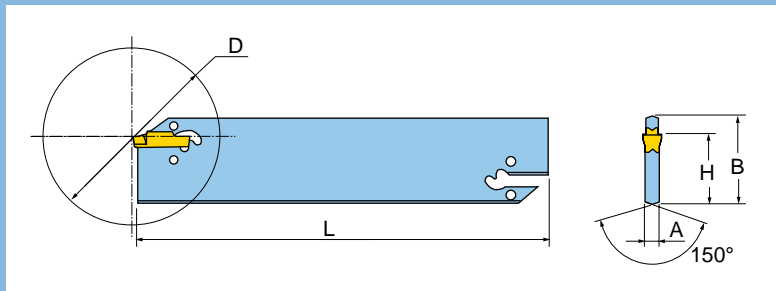
BLADES FOR PARTING AND DEEP GROOVING





Designation	Insert Seat Size	H (inch)	B (inch)	L (inch)	A (inch)	Dmax (inch)		
TGB45-4	4	1.50	1.77	5.90	0.126	6.30	EDG-33B	TTBU_-45
TGB45-4-L	4	1.50	1.77	8.85	0.126	-	EDG-33B	TTBU_-45

Use inserts TDC/TSC, TDJ/TSJ, TDUX, TDT, see pages 1274 - 1288.

TOCLAMP^{ULTRA+} TGB 52 CL

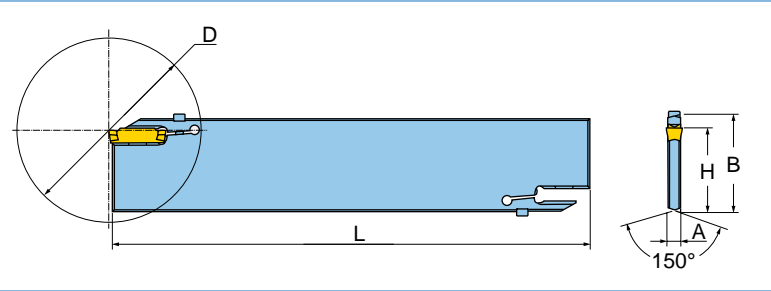
BLADES FOR PARTING AND DEEP GROOVING

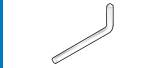

Designation	Insert Seat Size	H (inch)	B (inch)	L (inch)	A (inch)	Dmax (inch)			
TGB52-8-CL	8	1.78	2.05	9.84	0.268	3.94	L-W5	L-W3	SHM4X0.7X20-MO



Use inserts TDC/TSC, TDJ/TSJ, TDUX, TDT, see pages 1274 - 1288.

TOCLAMP^{ULTRA+} TGBR/L

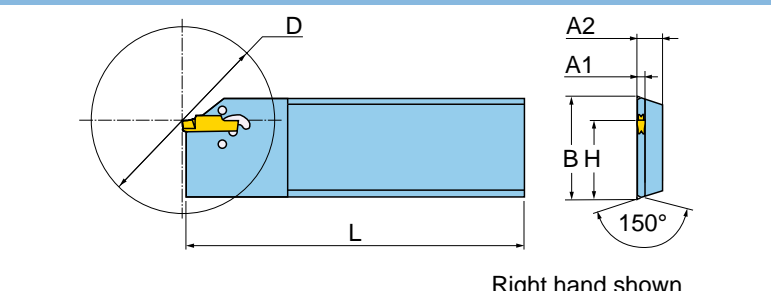
REINFORCED BLADES FOR PARTING AND DEEP GROOVING



Right hand shown

Designation	Insert Seat Size	H (inch)	B (inch)	L (inch)	A1 (inch)	A2 (inch)	Dmax (inch)			
TGBL32T24-2	2	0.98	1.26	4.33	0.063	0.31	1.65	EDG-33B	TTBU_-32	TTBN_-32
TGBL32T33-3	3	0.98	1.26	4.33	0.094	0.31	2.36	EDG-33B	TTBU_-32	TTBN_-32
TGBL32T41-4	4	0.98	1.26	4.33	0.126	0.31	3.15	EDG-33B	TTBU_-32	TTBN_-32
TGBR32T24-2	2	0.98	1.26	4.33	0.063	0.31	1.65	EDG-33B	TTBU_-32	TTBN_-32
TGBR32T33-3	3	0.98	1.26	4.33	0.094	0.31	2.36	EDG-33B	TTBU_-32	TTBN_-32
TGBR32T41-4	4	0.98	1.26	4.33	0.126	0.31	3.15	EDG-33B	TTBU_-32	TTBN_-32

Use inserts TDC/TSC, TDJ/TSJ, TDUX, TDT, see pages 1274 - 1288.

DEEP FACE GROOVING BLADES



Face Grooving

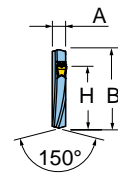
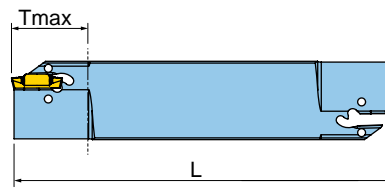
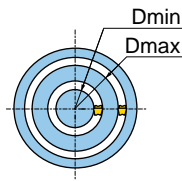

Designation	Insert Seat Size	H (inch)	B (inch)	L (inch)	A (inch)	Tmax (inch)	Dmin (inch)	Dmax (inch)
TGBFL32T20-40-60-3	3	0.976	1.26	5.90	0.205	0.787	1.57	2.36
TGBFL32T20-54-80-3	3	0.976	1.26	5.90	0.205	0.787	2.13	3.15
TGBFL32T25-74-120-3	3	0.976	1.26	5.90	0.205	0.984	2.91	4.72
TGBFL32T25-114-180-3	3	0.976	1.26	5.90	0.205	0.984	4.49	7.09
TGBFL32T25-40-60-4	4	0.976	1.26	5.90	0.205	0.984	1.57	2.36
TGBFL32T25-50-80-4	4	0.976	1.26	5.90	0.205	0.984	1.97	3.15
TGBFL32T30-70-130-4	4	0.976	1.26	5.90	0.205	1.181	2.76	5.12
TGBFL32T30-120-200-4	4	0.976	1.26	5.90	0.205	1.181	4.72	7.87
TGBFL32T32-60-95-5	5	0.976	1.26	5.90	0.205	1.260	2.36	3.74
TGBFL32T35-85-140-5	5	0.976	1.26	5.90	0.205	1.378	3.35	5.51
TGBFL32T35-130-250-5	5	0.976	1.26	5.90	0.205	1.378	5.12	9.84
TGBFL32T32-80-180-6	6	0.976	1.26	5.90	0.205	1.260	3.15	7.09
TGBFL32T38-168-300-6	6	0.976	1.26	5.90	0.205	1.496	6.61	7.09
TGBFR32T20-40-60-3	3	0.976	1.26	5.90	0.205	0.787	1.57	2.36
TGBFR32T20-54-80-3	3	0.976	1.26	5.90	0.205	0.787	2.13	3.15
TGBFR32T25-74-120-3	3	0.976	1.26	5.90	0.205	0.984	2.91	4.72
TGBFR32T25-114-180-3	3	0.976	1.26	5.90	0.205	0.984	4.49	7.09
TGBFR32T25-40-60-4	4	0.976	1.26	5.90	0.205	0.984	1.57	2.36
TGBFR32T25-50-80-4	4	0.976	1.26	5.90	0.205	0.984	1.97	3.15
TGBFR32T30-70-130-4	4	0.976	1.26	5.90	0.205	1.181	2.76	5.12
TGBFR32T30-120-200-4	4	0.976	1.26	5.90	0.205	1.181	4.72	7.87
TGBFR32T32-60-95-5	5	0.976	1.26	5.90	0.205	1.260	2.36	3.74
TGBFR32T35-85-140-5	5	0.976	1.26	5.90	0.205	1.378	3.35	5.51
TGBFR32T35-130-250-5	5	0.976	1.26	5.90	0.205	1.378	5.12	9.84
TGBFR32T32-80-180-6	6	0.976	1.26	5.90	0.205	1.260	3.15	7.09
TGBFR32T38-168-300-6	6	0.976	1.26	5.90	0.205	1.496	6.61	7.09

Use inserts TDC/TSC, TDJ/TSJ, TDUX, TDT, TDFI, [pages 1274 - 1288](#).

HARDWARE



Insert Extractor



Block



Block

EDG-33B

TTBU_-32

TTBN_-32



TOCLAMP TGB-MS

BLADES FOR MULTI-SPINDLE MACHINES
REPLACEMENT FOR HSS AND BRAZED TOOLS

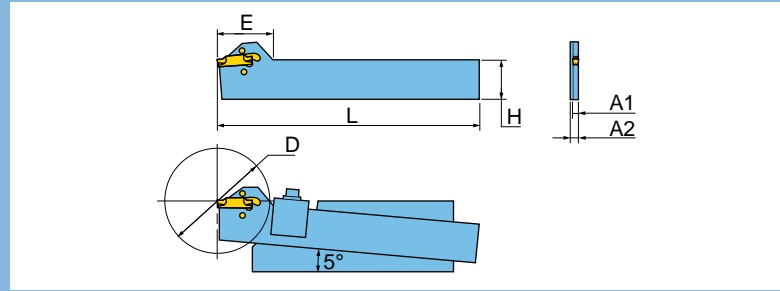



Designation	Insert Seat Size	H (inch)	L (inch)	A1 (inch)	A2 (inch)	Dmax (inch)	Insert Extractor
TGB5-22-2-MS	2	0.87	5.91	0.063	0.13	1.65	EDG-33B
TGB5-22-3-MS	3	0.87	5.91	0.094	0.13	2.36	EDG-33B
TGB5-22-4-MS	4	0.87	5.91	0.126	0.13	3.15	EDG-33B

Use inserts TDC/TSC, TDJ/TSJ, TDUX, TDT, see pages 1274 - 1288.

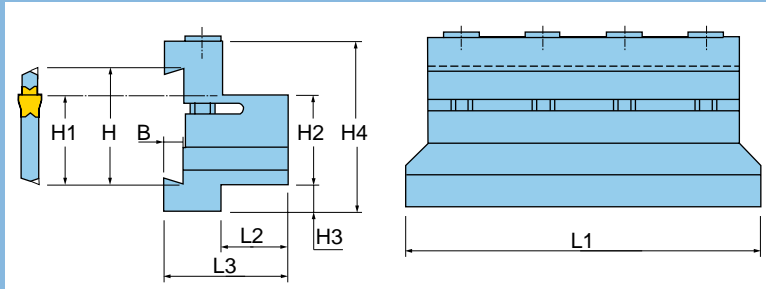

BLOCKS FOR PARTING AND DEEP GROOVING BLADES

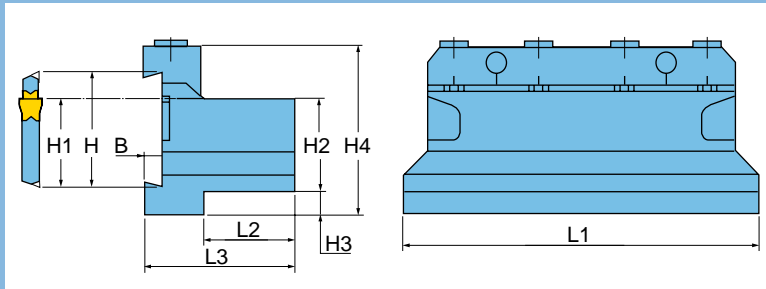

Designation	H (inch)	H1 (inch)	H2 (inch)	H3 (inch)	H4 (inch)	B (inch)	L1 (inch)	L2 (inch)	L3 (inch)		
TTBN19-26	1.02	0.84	0.75	0.35	1.50	0.16	3.43	0.75	1.30	SHM6X1X25	L-W5
TTBN19-32	1.26	0.98	0.75	0.55	1.89	0.22	3.94	0.75	1.38	SHM6X1X40	L-W5
TTBN25.4-32	1.26	0.98	1.00	0.30	1.89	0.22	4.33	0.79	1.42	SHM6X1X40	L-W5
TTBN31.8-32	1.26	0.98	1.25	0.13	1.89	0.22	4.72	1.10	1.73	SHM6X1X40	L-W5

BLOCKS FOR PARTING AND DEEP GROOVING BLADES, REMOVEABLE TOP CLAMP



Designation	H (inch)	H1 (inch)	H2 (inch)	H3 (inch)	H4 (inch)	B (inch)	L1 (inch)	L2 (inch)	L3 (inch)			
TTBU19-26	1.02	0.84	0.75	0.35	1.69	0.16	3.39	0.83	1.50	SRM6X30	BKU-86	L-W5
TTBU19-32	1.26	0.98	0.75	0.54	1.97	0.21	3.94	0.75	1.50	SRM6X30	BKU-110	L-W5
TTBU25.4-26	1.02	0.84	1.00	0.19	1.77	0.16	4.33	0.91	1.65	SRM6X30	BKU-100	L-W5
TTBU25.4-32	1.26	0.98	1.00	0.29	1.97	0.21	4.33	0.91	1.65	SRM6X30	BKU-110	L-W5
TTBU25.4-45	1.77	1.50	1.00	1.06	2.76	0.21	4.33	0.91	1.65	SRM6X30	BKU-110	L-W5
TTBU31.8-32	1.26	0.98	1.25	0.20	2.13	0.21	4.33	1.14	1.89	SRM6X30	BKU-110	L-W5

HOLDERS FOR PARTING AND DEEP GROOVING

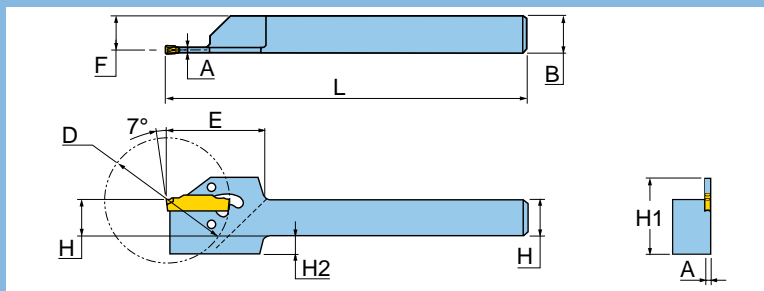

Designation	Insert Seat Size	F (inch)	L (inch)	DiaMax (TDJ/C)	DiaMax (TSJ/C)	H (inch)	B (inch)	E (inch)	A (inch)	H2 (inch)	
-------------	------------------	----------	----------	----------------	----------------	----------	----------	----------	----------	-----------	---

Inch

TGEL9.5-2	2	0.340	4.500	1.300	1.300	0.375	0.375	1.22	0.071	0.330	EDG-33B
TGEL12.7-2	2	0.465	4.500	1.380	1.380	0.500	0.500	1.22	0.071	0.210	EDG-33B
TGEL19-2	2	0.715	4.500	1.380	1.380	0.750	0.750	1.22	0.071	-	EDG-33B
TGEL12.7-3	3	0.453	4.500	1.500	1.570	0.500	0.500	1.22	0.094	0.210	EDG-33B
TGEL19-3	3	0.703	4.500	1.500	1.770	0.750	0.750	1.22	0.094	-	EDG-33B
TGEL25.4-3	3	0.953	6.000	1.500	1.770	1.000	1.000	1.22	0.094	-	EDG-33B
TGEL19-4	4	0.687	4.500	1.500	2.170	0.750	0.750	1.30	0.126	-	EDG-33B
TGEL25.4-4	4	0.937	6.000	1.500	2.170	1.000	1.000	1.30	0.126	-	EDG-33B
TGER9.5-2	2	0.340	4.500	1.300	1.300	0.375	0.375	1.22	0.071	0.330	EDG-33B
TGER12.7-2	2	0.465	4.500	1.380	1.380	0.500	0.500	1.22	0.071	0.210	EDG-33B
TGER19-2	2	0.715	4.500	1.380	1.380	0.750	0.750	1.22	0.071	-	EDG-33B
TGER12.7-3	3	0.453	4.500	1.500	1.570	0.500	0.500	1.22	0.094	0.210	EDG-33B
TGER19-3	3	0.703	4.500	1.500	1.770	0.750	0.750	1.22	0.094	-	EDG-33B
TGER25.4-3	3	0.953	6.000	1.500	1.770	1.000	1.000	1.22	0.094	-	EDG-33B
TGER19-4	4	0.687	4.500	1.500	2.170	0.750	0.750	1.30	0.126	-	EDG-33B
TGER25.4-4	4	0.937	6.000	1.500	2.170	1.000	1.000	1.30	0.126	-	EDG-33B

Metric

TGEL1212-2	2	0.440	5.910	1.380	1.380	0.470	0.500	1.22	0.071	0.240	EDG-33B
TGEL1616-2	2	0.594	5.910	1.380	1.380	0.630	0.630	1.22	0.066	0.080	EDG-33B
TGEL1212-3	3	0.430	5.910	1.500	1.570	0.470	0.500	1.22	0.094	0.240	EDG-33B
TGEL1616-3	3	0.583	5.910	1.500	1.770	0.630	0.630	1.22	0.094	0.240	EDG-33B
TGER1212-2	2	0.440	5.910	1.380	1.380	0.470	0.500	1.22	0.071	0.240	EDG-33B
TGER1616-2	2	0.594	5.910	1.380	1.380	0.630	0.630	1.22	0.066	0.080	EDG-33B
TGER1212-3	3	0.430	5.910	1.500	1.570	0.470	0.500	1.22	0.094	0.240	EDG-33B
TGER1616-3	3	0.583	5.910	1.500	1.770	0.630	0.630	1.22	0.094	0.240	EDG-33B

Use inserts TDC/TSC, TDJ/TSJ, TDUX, TDT, see [pages 1274 - 1288](#).

PARALLEL HOLDERS FOR MODULAR BLADES



OD Turning



Face Groove Turn

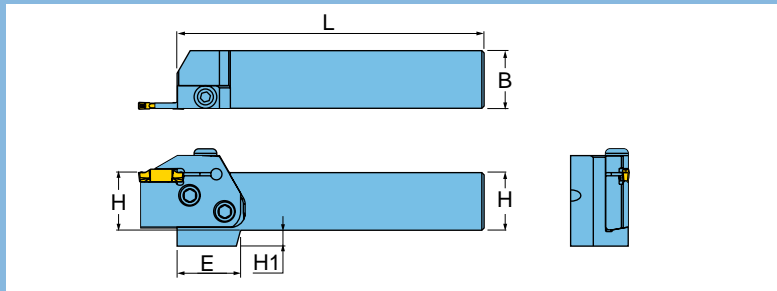

Designation	ISO Number	H (inch)	B (inch)	L (inch)	E (inch)	H1 (inch)
TCHL19	TCHL19	0.750	0.750	6.000	1.380	0.470
TCHL25.4	TCHL25.4	1.000	1.000	6.000	1.100	0.280
TCHL31.8	TCHL31.8	1.250	1.250	6.000	1.100	-
TCHR19	TCHR19	0.750	0.750	6.000	1.380	0.470
TCHR25.4	TCHR25.4	1.000	1.000	6.000	1.100	0.280
TCHR31.8	TCHR31.8	1.250	1.250	6.000	1.100	-

Use adapters TCER/L and TCFR/L, pages 1314, 1315.

HARDWARE						
	Screw	EXTERNAL LH ADAPTER	EXTERNAL RH ADAPTER	FACE LH ADAPTER	FACE RH ADAPTER	Wrench
TCHL19	TS60190I	TCEL	-	-	TCFR	L-W4
TCHL25.4	TS60190I	TCEL	-	-	TCFR	L-W4
TCHL31.8	TS60190I	TCEL	-	-	TCFR	L-W4
TCHR19	TS60190I	-	TCER	TCFL	-	L-W4
TCHR25.4	TS60190I	-	TCER	TCFL	-	L-W4
TCHR31.8	TS60190I	-	TCER	TCFL	-	L-W4

Adapter and holder selection

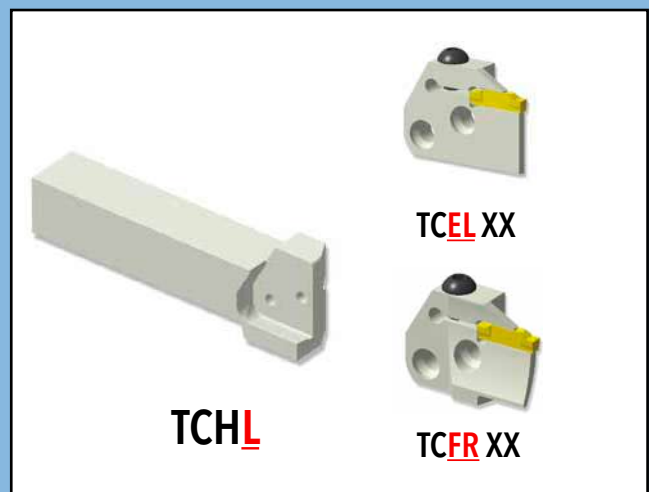
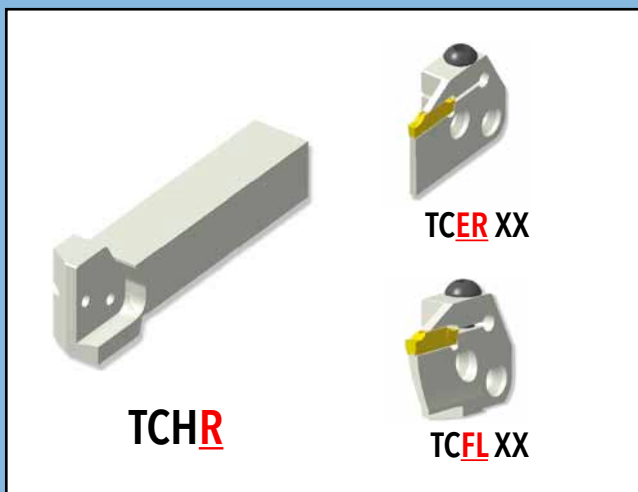

PERPENDICULAR HOLDERS FOR MODULAR BLADES



OD Turning



Face Groove Turn

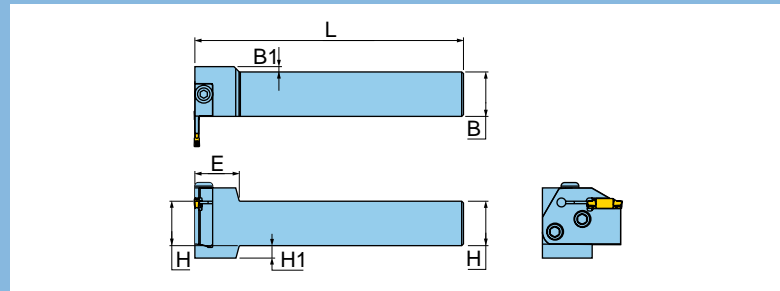

Designation	H (inch)	B (inch)	L (inch)	E (inch)	B1 (inch)	H1 (inch)
TCHPL19	0.750	0.750	6.000	0.980	0.295	0.470
TCHPL25.4	1.000	1.000	6.000	0.980	0.118	0.280
TCHPL31.8	1.250	1.250	6.000	0.980	0.295	-
TCHPR19	0.750	0.750	6.000	0.980	0.295	0.470
TCHPR25.4	1.000	1.000	6.000	0.980	0.118	0.280
TCHPR31.8	1.250	1.250	6.000	0.980	0.295	-

Use adapters TCER/L and TCFR/L, [pages 1314, 1315](#).

HARDWARE						
	Screw	EXTERNAL LH ADAPTER	EXTERNAL RH ADAPTER	FACE LH ADAPTER	FACE RH ADAPTER	Wrench
TCHPL19	TS60190I	-	TCER	TCFL	-	L-W4
TCHPL25.4	TS60190I	-	TCER	TCFL	-	L-W4
TCHPL31.8	TS60190I	-	TCER	TCFL	-	L-W4
TCHPR19	TS60190I	TCEL	-	-	TCFR	L-W4
TCHPR25.4	TS60190I	TCEL	-	-	TCFR	L-W4
TCHPR31.8	TS60190I	TCEL	-	-	TCFR	L-W4

Adapter and holder selection

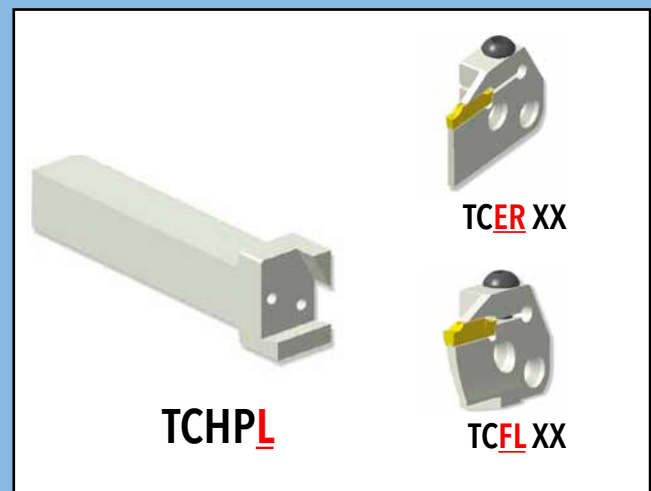
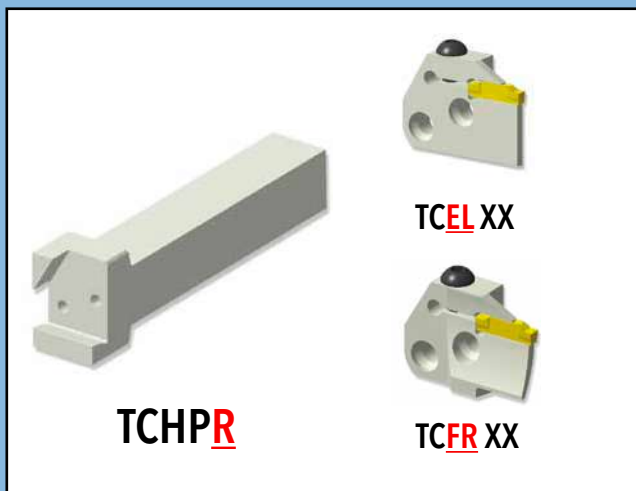

TOCLAMP^{ULTRA+} TCHN QUICK-CHANGE*

ADAPTER FOR EXTERNAL TURNING AND GROOVING (LEFT HAND OR RIGHT HAND) OR FACE TURNING AND GROOVING



OD Turning

Face Groove Turn

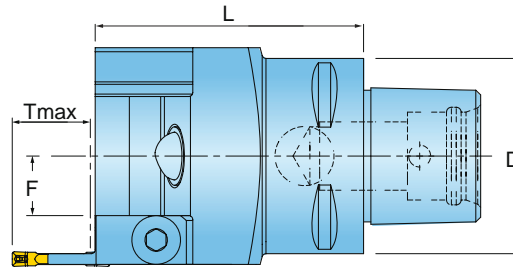

Designation	L (inch)	D (mm)	F (inch)
C4-TCHN	2.16	40 mm	0.480
C5-TCHN	2.28	50 mm	0.677
C6-TCHN	2.36	63 mm	0.874

*Coromant CAPTO connection. CAPTO is a registered trademark of Sandvik AB. Use clamps TCFL, TCEL, TCFR, TCER, pages 1314 - 1316.

HARDWARE



Screw

TS60190I



FACE LH ADAPTER

TCFL



EXTERNAL LH ADAPTER

TCEL



FACE RH ADAPTER

TCFR



EXTERNAL RH ADAPTER

TCER



Wrench

L-W3



Nozzle

NZ125

TOCLAMP^{ULTRA+} TCHPN QUICK-CHANGE*

ADAPTER FOR EXTERNAL TURNING AND GROOVING (LEFT HAND OR RIGHT HAND) OR FACE TURNING AND GROOVING



OD Turning

Face Grooving

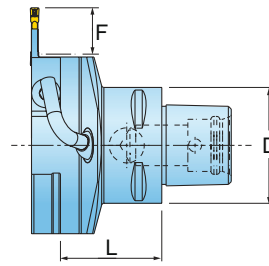

Designation	L (inch)	D (mm)	F (inch)
C4-TCHPN	1.38	40 mm	1.181
C5-TCHPN	1.57	50 mm	1.398
C6-TCHPN	1.65	63 mm	1.398

*Coromant CAPTO connection. CAPTO is a registered trademark of Sandvik AB. Use clamps TCFL, TCEL, TCFR, TCER, pages 1314 - 1316.

HARDWARE



Screw

TS60190I



FACE LH ADAPTER

TCFL



EXTERNAL LH ADAPTER

TCEL



FACE RH ADAPTER

TCFR



EXTERNAL RH ADAPTER

TCER



Wrench

L-W3



Nozzle

NZ125

ADAPTER FOR EXTERNAL TURNING AND GROOVING (LEFT HAND)

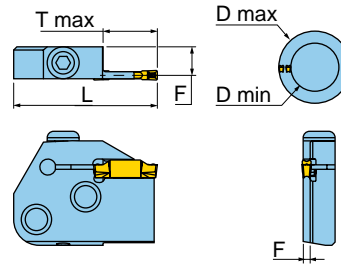

Designation	Insert Seat Size	L (inch)	A (inch)	F (inch)	Tmax (inch)
TCEL3T16	3	1.77	0.087	0.350	0.63
TCEL4T16	4	1.77	0.118	0.335	0.63
TCEL5T20	5	1.97	0.157	0.315	0.79
TCEL6T20	6	1.97	0.197	0.305	0.79
TCEL8T25	8	2.17	0.236	0.286	0.98

Use Holders TCHL, TCHPR, TCHN, TCHPN pages 1311, 1312, 1313. Use inserts TDC/TSC*, TDJ/TSJ*, TD XU, TDT, see pages 1274 - 1288.

*Grooving only

HARDWARE



TCHL TCHPR BHM6X1X20 L-W4

ADAPTER FOR EXTERNAL TURNING AND GROOVING (RIGHT HAND)

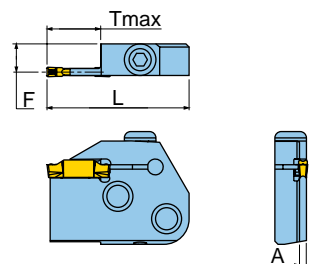
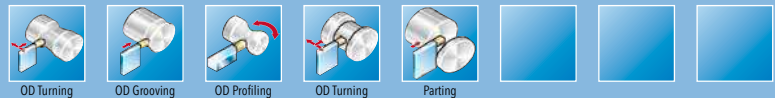

Designation	Insert Seat Size	L (inch)	A (inch)	F (inch)	Tmax (inch)
TCER3T16	3	1.77	0.087	0.350	0.63
TCER4T16	4	1.77	0.118	0.335	0.63
TCER5T20	5	1.97	0.157	0.315	0.79
TCER6T20	6	1.97	0.197	0.305	0.79
TCER8T25	8	2.17	0.236	0.286	0.98

Use Holders TCHL, TCHPR, TCHN, TCHPN pages 1311, 1312, 1313. Use inserts TDC/TSC*, TDJ/TSJ*, TD XU, TDT, see pages 1274 - 1288.

*Grooving only

HARDWARE



TCHR TCHPL BHM6X1X20 L-W4

ADAPTER FOR EXTERNAL FACE GROOVING AND TURNING (RIGHT HAND)



Face Turning



Face Grooving

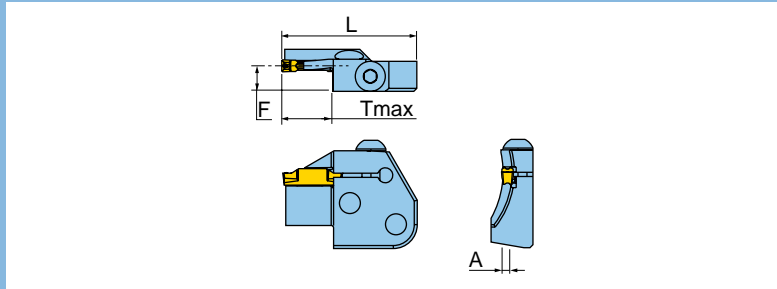

Designation	Insert Seat Size	L (inch)	F (inch)	Tmax (inch)	Dmin (inch)	Dmax (inch)
TCFR3T12-40-55RN	3	1.77	0.350	0.472	1.58	2.17
TCFR3T12-55-75RN	3	1.77	0.350	0.472	2.17	2.95
TCFR3T12-75-100RN	3	1.77	0.350	0.472	2.95	3.94
TCFR3T12-100-140RN	3	1.77	0.350	0.472	3.94	5.51
TCFR3T12-140-200RN	3	1.77	0.350	0.472	5.51	7.87
TCFR4T16-50-70RN	4	1.77	0.335	0.630	1.97	2.76
TCFR4T16-70-100RN	4	1.77	0.335	0.630	2.76	3.94
TCFR4T16-100-150RN	4	1.77	0.335	0.630	3.94	5.91
TCFR4T16-150-250RN	4	1.77	0.335	0.630	5.91	9.84
TCFR5T20-55-80RN	5	1.97	0.315	0.787	2.17	3.15
TCFR5T20-80-120RN	5	1.97	0.315	0.787	3.15	4.72
TCFR5T20-120-180RN	5	1.97	0.315	0.787	4.72	7.09
TCFR5T20-180-300RN	5	1.97	0.315	0.787	7.09	11.81
TCFR6T25-60-90RN	6	5.50	0.305	0.984	2.36	3.54
TCFR6T25-90-150RN	6	5.50	0.305	0.984	3.54	5.91
TCFR6T25-150-250RN	6	5.50	0.305	0.984	5.91	9.84
TCFR6T25-250-400RN	6	5.50	0.305	0.984	9.84	15.75

Use Holders TCHL, TCHPR, TCHN, TCHPN pages 1311, 1312, 1313. Use inserts TDC/TSC*, TDJ/TSJ*, TD XU, TDT, see pages 1274 - 1288.

*Grooving only

HARDWARE			
Holder	Holder	Clamp Screw	Wrench
TCHL	TCHPR	BHM6X1X20	L-W4

ADAPTER FOR EXTERNAL FACE GROOVING AND TURNING (LEFT HAND)



Face Turning



Face Grooving

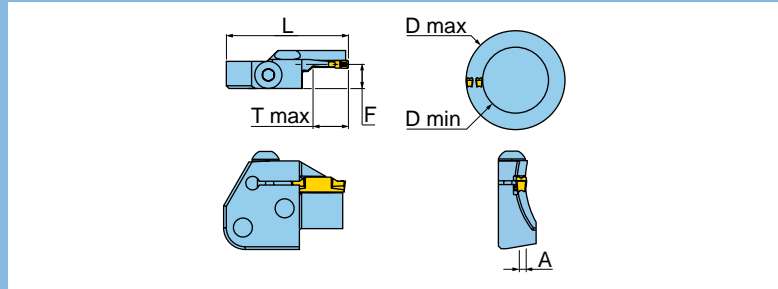

Designation	Insert Seat Size	L (inch)	F (inch)	Tmax (inch)	Dmin (inch)	Dmax (inch)
TCFL3T12-40-55RN	3	1.77	0.350	0.472	1.58	2.17
TCFL3T12-55-75RN	3	1.77	0.350	0.472	2.17	2.95
TCFL3T12-75-100RN	3	1.77	0.350	0.472	2.95	3.94
TCFL3T12-100-140RN	3	1.77	0.350	0.472	3.94	5.51
TCFL3T12-140-200RN	3	1.77	0.350	0.472	5.51	7.87
TCFL4T16-50-70RN	4	1.77	0.335	0.630	1.97	2.76
TCFL4T16-70-100RN	4	1.77	0.335	0.630	2.76	3.94
TCFL4T16-100-150RN	4	1.77	0.335	0.630	3.94	5.91
TCFL4T16-150-250RN	4	1.77	0.335	0.630	5.91	9.84
TCFL5T20-55-80RN	5	1.97	0.315	0.787	2.17	3.15
TCFL5T20-80-120RN	5	1.97	0.315	0.787	3.15	4.72
TCFL5T20-120-180RN	5	1.97	0.315	0.787	4.72	7.09
TCFL5T20-180-300RN	5	1.97	0.315	0.787	7.09	11.81
TCFL6T25-60-90RN	6	5.50	0.305	0.984	2.36	3.54
TCFL6T25-90-150RN	6	5.50	0.305	0.984	3.54	5.91
TCFL6T25-150-250RN	6	5.50	0.305	0.984	5.91	9.84
TCFL6T25-250-400RN	6	5.50	0.305	0.984	9.84	15.75

Use Holders TCHL, TCHPR, TCHN, TCHPN pages 1311, 1312, 1313. Use inserts TDC/TSC*, TDJ/TSJ*, TDXU, TDT, see pages 1274 - 1288.

HARDWARE



Holder

TCHR



Holder

TCHPL



Clamp Screw

BHM6X1X20



Clamp Screw Wrench

L-W4

SHORT TMAX HOLDERS FOR EXTERNAL TURNING AND GROOVING



OD Profiling



OD Turning



OD Grooving



Parting

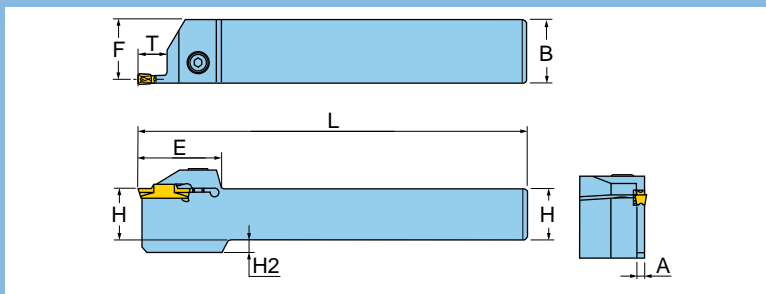

Designation	Insert Seat Size	F (inch)	L (inch)	H (inch)	B (inch)	E (inch)	Tmax (inch)	A (inch)		
TTER1616-2T08	2	0.600	4.33	0.630	0.630	1.300	0.315	0.090	SHM5X0.8X20	L-W4
TTER1616-3T09	3	0.590	4.33	0.630	0.630	1.260	0.354	0.090	SHM5X0.8X16	L-W4
TTER19-3T09	3	0.750	5.00	0.750	0.750	1.260	0.354	0.083	SHM6X1X16	L-W4
TTER25.4-3T09	3	0.940	6.00	1.000	1.000	1.260	0.354	0.083	SHM5X0.8X25	L-W4
TTEL19-4T10	4	0.730	5.00	0.750	0.750	1.300	0.394	0.114	SHM6X1X16	L-W4
TTEL25.4-4T10	4	0.930	6.00	1.000	1.000	1.300	0.394	0.114	SHM6X1X20	L-W4
TTER1616-4T10	4	0.570	4.33	0.630	0.630	1.300	0.354	0.110	SHM6X1X16	L-W4
TTER19-4T10	4	0.730	5.00	0.750	0.750	1.300	0.394	0.114	SHM6X1X20	L-W4
TTER25.4-4T10	4	0.930	6.00	1.000	1.000	1.300	0.394	0.114	SHM6X1X25	L-W4
TTER19-5T12	5	0.710	5.00	0.750	0.750	1.460	0.472	0.154	SHM6X1X20	L-W4
TTER25.4-5T12	5	0.910	6.00	1.000	1.000	1.460	0.472	0.154	SHM6X1X25	L-W4
TTER19-6T12	6	0.690	5.00	0.750	0.750	1.460	0.472	0.193	SHM6X1X20	L-W4
TTER25.4-6T12	6	0.890	6.00	1.000	1.000	1.460	0.472	0.193	SHM6X1X25	L-W4

Use inserts TDC/TSC*, TDJ/TSJ*, TDXU, TDT, see pages 1274 - 1288.

*Grooving only

MIDDLE TMAX HOLDERS FOR EXTERNAL TURNING AND GROOVING

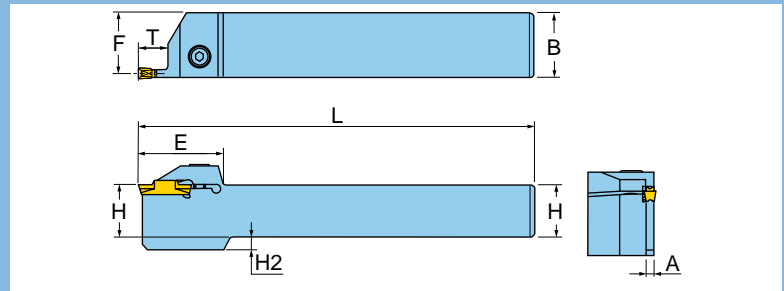

Designation	Insert Seat Size	F (inch)	L (inch)	H (inch)	B (inch)	E (inch)	Tmax (inch)	A (inch)	Screw		Wrench	
TTEL1616-2	2	0.590	4.30	0.630	0.630	1.260	0.472	0.063	SHM5X0.8X16	L-W4		
TTEL19-2	2	0.710	5.00	0.750	0.750	1.260	0.472	0.063	SHM5X0.8X20	L-W4		
TTEL25.4-2	2	0.960	6.00	1.000	1.000	1.260	0.472	0.063	SHM5X0.8X25	L-W4		
TTER1616-2	2	0.590	4.30	0.630	0.630	1.260	0.472	0.063	SHM5X0.8X16	L-W4		
TTER19-2	2	0.710	5.00	0.750	0.750	1.260	0.472	0.063	SHM5X0.8X20	L-W4		
TTER25.4-2	2	0.960	6.00	1.000	1.000	1.260	0.472	0.063	SHM5X0.8X25	L-W4		
TTEL1616-3	3	0.590	4.30	0.630	0.630	1.260	0.472	0.083	SHM5X0.8X16	L-W4		
TTEL19-3	3	0.710	5.00	0.750	0.750	1.260	0.472	0.083	SHM5X0.8X20	L-W4		
TTEL25.4-3	3	0.960	6.00	1.000	1.000	1.260	0.472	0.083	SHM5X0.8X25	L-W4		
TTEL31.8-3	3	1.200	7.00	1.250	1.250	1.260	0.472	0.083	SHM5X0.8X20	L-W4		
TTER1616-3	3	0.590	4.30	0.630	0.630	1.260	0.472	0.083	SHM5X0.8X16	L-W4		
TTER19-3	3	0.710	5.00	0.750	0.750	1.260	0.472	0.083	SHM5X0.8X20	L-W4		
TTER25.4-3	3	0.960	6.00	1.000	1.000	1.260	0.472	0.083	SHM5X0.8X25	L-W4		
TTER31.8-3	3	1.200	7.00	1.250	1.250	1.260	0.472	0.083	SHM5X0.8X25	L-W4		
TTEL19-4	4	0.690	5.00	0.750	0.750	1.300	0.590	0.114	SHM6X1X20	L-W5		
TTEL25.4-4	4	0.940	6.00	1.000	1.000	1.300	0.590	0.114	SHM6X1X25	L-W5		
TTEL31.8-4	4	1.200	7.00	1.250	1.250	1.300	0.590	0.114	SHM6X1X25	L-W5		
TTER19-4	4	0.690	5.00	0.750	0.750	1.300	0.590	0.114	SHM6X1X20	L-W5		
TTER25.4-4	4	0.940	6.00	1.000	1.000	1.300	0.590	0.114	SHM6X1X25	L-W5		
TTER31.8-4	4	1.200	7.00	1.250	1.250	1.300	0.590	0.114	SHM6X1X25	L-W5		
TTEL19-5	5	0.670	5.00	0.750	0.750	1.460	0.787	0.154	SHM6X1X20	L-W5		
TTEL25.4-5	5	0.920	6.00	1.000	1.000	1.460	0.787	0.154	SHM6X1X25	L-W5		
TTER19-5	5	0.670	5.00	0.750	0.750	1.460	0.787	0.154	SHM6X1X20	L-W5		
TTER25.4-5	5	0.920	6.00	1.000	1.000	1.460	0.787	0.154	SHM6X1X25	L-W5		
TTER31.8-5	5	1.170	7.00	1.250	1.250	1.460	0.787	0.154	SHM6X1X25	L-W5		
TTEL19-6	6	0.650	5.00	0.750	0.750	1.460	0.787	0.193	SHM8X1.25X20	L-W6		
TTEL25.4-6	6	0.900	6.00	1.000	1.000	1.460	0.787	0.193	-	-		
TTER19-6	6	0.650	5.00	0.750	0.750	1.460	0.787	0.193	SHM8X1.25X20	L-W6		
TTER25.4-6	6	0.900	6.00	1.000	1.000	1.460	0.787	0.193	SHM8X1.25X25	L-W6		
TTER31.8-6	6	1.150	7.00	1.250	1.250	1.610	0.787	0.191	SHM8X1.25X25	L-W6		
TTEL25.4-8	8	0.880	6.00	1.000	1.000	1.650	0.984	0.232	-	-		
TTEL31.8-8	8	1.130	7.00	1.250	1.250	1.650	0.984	0.232	SHM8X1.25X25	L-W6		
TTER25.4-8	8	0.880	6.00	1.000	1.000	1.650	0.984	0.232	SHM8X1.25X25	L-W6		
TTER31.8-8	8	1.130	7.00	1.250	1.250	1.650	0.984	0.232	SHM8X1.25X25	L-W6		

Use inserts TDC/TSC*, TDJ/TSJ*, TDJU, TDT, TDA/TSA pages 1274 - 1288, 1291.

*Grooving only

LONG TMAX HOLDERS FOR EXTERNAL TURNING AND GROOVING

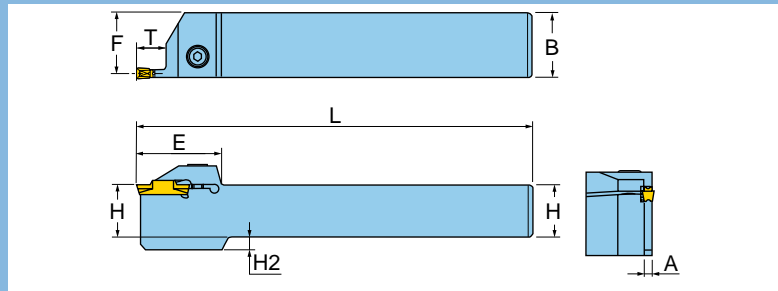

Designation	Insert Seat Size	F (inch)	L (inch)	H (inch)	B (inch)	E (inch)	Tmax (inch)	A (inch)		
									Screw	Wrench
TTEL15.9-2T17	2	0.590	4.50	0.625	0.630	1.460	0.670	0.071	SHM5X0.8X16	L-W4
TTEL19-2T17	2	0.710	5.00	0.750	0.750	1.460	0.670	0.071	SHM5X0.8X20	L-W4
TTEL25.4-2T17	2	0.960	6.00	1.000	1.000	1.460	0.670	0.071	SHM5X0.8X25	L-W4
TTEL15.9-3T20	3	0.580	4.50	0.630	0.630	1.520	0.790	0.094	SHM5X0.8X16	L-W4
TTEL19-3T16	3	0.700	5.00	0.750	0.750	1.420	0.630	0.094	SHM5X0.8X20	L-W4
TTEL19-3T20	3	0.700	5.00	0.750	0.750	1.520	0.790	0.094	SHM5X0.8X20	L-W4
TTEL25.4-3T25	3	0.950	6.00	1.000	1.000	1.750	0.980	0.094	SHM5X0.8X25	L-W4
TTEL19-4T25	4	0.690	6.00	0.750	0.750	1.770	0.980	0.118	SHM5X0.8X20	L-W4
TTEL25.4-4T25	4	0.940	6.00	1.000	1.000	1.770	0.980	0.118	SHM5X0.8X25	L-W4
TTEL25.4-5T32	5	0.920	6.00	1.000	1.000	2.000	1.260	0.156	SHM6X1X25	L-W5
TTEL25.4-6T32	6	0.900	6.00	1.000	1.000	2.200	1.260	0.195	SHM6X1X25	L-W5
TTER15.9-2T17	2	0.590	4.50	0.630	0.630	1.460	0.670	0.071	SHM5X0.8X16	L-W4
TTER19-2T17	2	0.710	5.00	0.750	0.750	1.460	0.670	0.071	SHM5X0.8X20	L-W4
TTER25.4-2T17	2	0.960	6.00	1.000	1.000	1.460	0.670	0.071	SHM5X0.8X25	L-W4
TTER15.9-3T20	3	0.580	4.50	0.630	0.630	1.520	0.790	0.094	SHM5X0.8X16	L-W4
TTER19-3T16	3	0.700	5.00	0.750	0.750	1.420	0.630	0.094	SHM5X0.8X20	L-W4
TTER19-3T20	3	0.700	5.00	0.750	0.750	1.520	0.790	0.094	SHM5X0.8X20	L-W4
TTER25.4-3T25	3	0.950	6.00	1.000	1.000	1.750	0.980	0.094	SHM5X0.8X25	L-W4
TTER19-4T25	4	0.690	6.00	0.750	0.750	1.770	0.980	0.118	SHM5X0.8X20	L-W4
TTER25.4-4T25	4	0.940	6.00	1.000	1.000	1.770	0.980	0.118	SHM5X0.8X25	L-W4
TTER25.4-5T32	5	0.920	6.00	1.000	1.000	2.000	1.260	0.156	SHM6X1X25	L-W5
TTER25.4-6T32	6	0.900	6.00	1.000	1.000	2.200	1.260	0.195	SHM6X1X25	L-W5

Use inserts TDC/TSC*, TDJ/TSJ*, TDXU, TDT, TDA/TSA pages 1274 - 1288, 1291.

*Grooving only

EXTERNAL TURNING AND GROOVING HOLDERS FOR SWISS AUTOMATICS

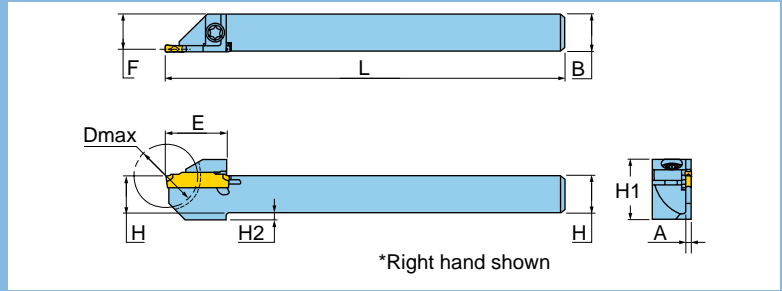

Designation	Ins. Seat Size	H (inch)	B (inch)	L (inch)	E (inch)	F (inch)	A (inch)	H1 (inch)	H2 (inch)	Dmax (inch)
Inch										
TTEL9.5-20-1.4SH	1	0.375	0.375	5.00	0.710	0.350	0.045	0.540	-	0.790
TTEL12.7-24-1.4SH	1	0.500	0.500	5.00	0.770	0.480	0.045	0.620	-	0.940
TTEL9.5-20-2SH	1	0.375	0.375	5.00	0.750	0.340	0.069	0.690	-	0.790
TTEL12.7-24-2SH	2	0.500	0.500	5.00	0.750	0.470	0.069	0.750	-	0.940
TTEL15.9-32-2SH	2	0.625	0.625	5.00	0.940	0.590	0.070	0.820	-	1.260
TTEL12.7-24-3SH	3	0.500	0.500	5.00	0.750	0.460	0.094	0.770	0.080	0.940
TTEL15.9-32-3SH	3	0.625	0.625	5.00	0.940	0.580	0.094	0.820	-	1.260
TTER9.5-20-1.4SH	1	0.375	0.375	5.00	0.710	0.350	0.045	0.540	-	0.790
TTER12.7-24-1.4SH	1	0.500	0.500	5.00	0.770	0.480	0.045	0.620	-	0.940
TTER9.5-20-2SH	1	0.375	0.375	5.00	0.750	0.340	0.069	0.690	-	0.790
TTER12.7-24-2SH	2	0.500	0.500	5.00	0.750	0.470	0.069	0.750	-	0.940
TTER15.9-32-2SH	2	0.625	0.625	5.00	0.940	0.590	0.070	0.820	-	1.260
TTER12.7-24-3SH	3	0.500	0.500	5.00	0.750	0.460	0.094	0.770	0.080	0.940
TTER15.9-32-3SH	3	0.625	0.625	5.00	0.940	0.580	0.094	0.820	-	1.260
Metric										
TTEL10-20-1.4SH	1	10	10	4.92	0.710	0.370	0.039	0.540	-	0.790
TTEL14-24-1.4SH	1	14	14	4.92	0.770	0.530	0.039	0.700	-	0.940
TTEL16-32-1.4SH	1	16	16	4.92	0.940	0.610	0.039	0.780	-	1.260
TTEL10-20-2SH	2	10	10	4.92	0.750	0.360	0.061	0.690	0.080	0.790
TTEL12-24-2SH	2	12	12	4.92	0.750	0.440	0.061	0.750	0.080	0.940
TTEL14-24-2SH	2	14	14	4.92	0.750	0.520	0.061	0.750	-	0.940
TTEL16-32-2SH	2	16	16	4.92	0.940	0.600	0.061	0.830	-	1.260
TTEL12-24-3SH	3	12	12	4.92	0.748	0.425	0.094	0.748	0.080	-
TTEL16-32-3SH	3	16	16	4.92	0.940	0.583	0.094	0.830	-	32.000
TTER10-20-1.4SH	1	10	10	4.92	0.710	0.370	0.039	0.540	-	0.790
TTER12-24-1.4SH	1	12	12	4.92	0.770	0.450	0.039	0.620	-	0.940
TTER14-24-1.4SH	1	14	14	4.92	0.770	0.530	0.039	0.700	-	0.940
TTER16-32-1.4SH	1	16	16	4.92	0.940	0.610	0.039	0.780	-	1.260
TTER10-20-2SH	2	10	10	4.92	0.750	0.360	0.061	0.690	0.080	0.790
TTER12-24-2SH	2	12	12	4.92	0.750	0.440	0.061	0.750	0.080	0.940
TTER14-24-2SH	2	14	14	4.92	0.750	0.520	0.061	0.750	-	0.940
TTER16-32-2SH	2	16	16	4.92	0.940	0.600	0.061	0.830	-	1.260
TTER12-24-3SH	3	12	12	4.92	0.748	0.425	0.094	0.748	0.080	-
TTER16-32-3SH	3	16	16	4.92	0.940	0.583	0.094	0.830	-	32.000

Use inserts TDC/TSC*, TDJ/TSJ*, TDXU, TDT, see pages 1274 - 1288.

*Grooving only

EXTERNAL TURNING AND GROOVING HOLDERS FOR SWISS AUTOMATICS



OD Profiling

OD Turning

OD Grooving

Parting

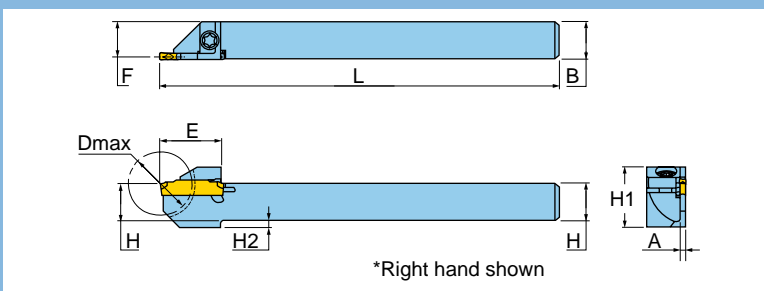

HARDWARE



Screw



Torx Driver

Inch

TTEL9.5-20-1.4SH	SR34-535	DS-T15S
TTEL12.7-24-1.4SH	SR34-535	DS-T15S
TTEL9.5-20-2SH	SR34-535	DS-T15S
TTEL12.7-24-2SH	SR34-535	DS-T15S
TTEL15.9-32-2SH	SR34-535	DS-T15S
TTEL12.7-24-3SH	SR34-535	DS-T15S
TTEL15.9-32-3SH	SR34-535	DS-T15S
TTER9.5-20-1.4SH	SR34-535	DS-T15S
TTER12.7-24-1.4SH	SR34-535	DS-T15S
TTER9.5-20-2SH	SR34-535	DS-T15S
TTER12.7-24-2SH	SR34-535	DS-T15S
TTER15.9-32-2SH	SR34-535	DS-T15S
TTER12.7-24-3SH	SR34-535	DS-T15S
TTER15.9-32-3SH	SR34-535	DS-T15S

Metric

TTEL10-20-1.4SH	SR34-535	DS-T15S
TTEL14-24-1.4SH	SR34-535	DS-T15S
TTEL16-32-1.4SH	SR34-535	DS-T15S
TTEL10-20-2SH	SR34-535	DS-T15S
TTEL12-24-2SH	SR34-535	DS-T15S
TTEL14-24-2SH	SR34-535	DS-T15S
TTEL16-32-2SH	SR34-535	DS-T15S
TTEL12-24-3SH	SR34-535	DS-T15S
TTEL16-32-3SH	SR34-535	DS-T15S
TTER10-20-1.4SH	SR34-535	DS-T15S
TTER12-24-1.4SH	SR34-535	DS-T15S
TTER14-24-1.4SH	SR34-535	DS-T15S
TTER16-32-1.4SH	SR34-535	DS-T15S
TTER10-20-2SH	SR34-535	DS-T15S
TTER12-24-2SH	SR34-535	DS-T15S
TTER14-24-2SH	SR34-535	DS-T15S
TTER16-32-2SH	SR34-535	DS-T15S
TTER12-24-3SH	SR34-535	DS-T15S
TTER16-32-3SH	SR34-535	DS-T15S

Use inserts TDC/TSC*, TDJ/TSJ*, TD XU, TDT, see pages 1274 - 1288.

*Grooving only

EXTERNAL HOLDERS FOR SHALLOW FACE PRECISION GROOVING AND FACE TURNING



Face turning



Face Groove

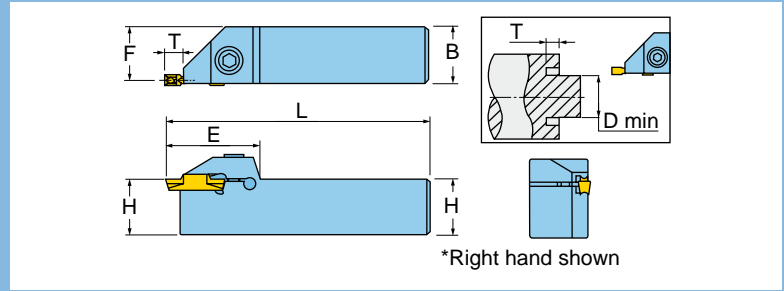

Designation	Insert Seat Size	H (inch)	B (inch)	L (inch)	F (inch)	E (inch)	Tmax (inch)	Dmin (inch)	Screw	Wrench
TGFL19-4	2, 3, 4	0.750	0.75	5.00	0.69	1.30	0.236	1.18	SHM6X1X20	L-W5
TGFL25.4-4	2, 3, 4	1.000	1	6.00	0.94	1.30	0.236	1.18	SHM6X1X25	L-W5
TGFL19-6	5, 6	0.750	0.75	5.00	0.65	1.46	0.236	2.36	SHM6X1X20	L-W5
TGFR19-4	2, 3, 4	0.750	0.75	5.00	0.69	1.30	0.236	1.18	SHM6X1X20	L-W5
TGFR25.4-4	2, 3, 4	1.000	1	6.00	0.94	1.30	0.236	1.18	SHM6X1X25	L-W5
TGFR25.4-6	5, 6	1.000	1	6.00	0.90	1.46	0.236	2.36	SHM6X1X25	L-W5

Use inserts TDC/TSC*, TDJ/TSJ*, TD XU, TDT, TDFT, see pages 1274 - 1288.

*Grooving only

EXTERNAL HOLDERS FOR SHALLOW FACE PERPENDICULAR GROOVING AND FACE TURNING



Face turning



Face Groove

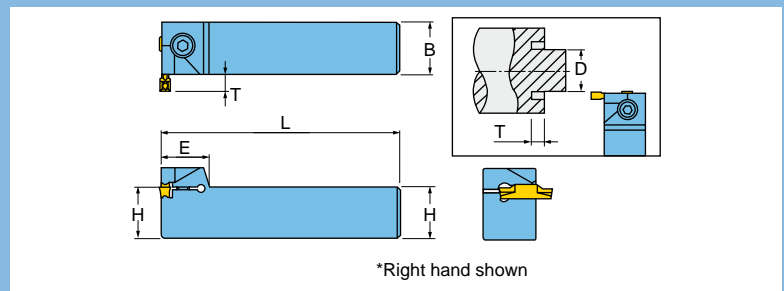

Designation	Insert Seat Size	H (inch)	B (inch)	L (inch)	F (inch)	E (inch)	Tmax (inch)	Dmin (inch)	Screw	Wrench
TGFPL25.4-4	2, 3, 4	1.000	1	6.00	-	0.72	0.189	1.18	SHM6X1X25	L-W5
TGFPL31.8-4	2, 3, 4	1.250	1.25	6.00	-	0.72	0.189	1.18	SHM6X1X25	L-W5
TGFPR31.8-4	2, 3, 4	1.250	1.25	6.00	-	0.72	0.189	1.18	SHM6X1X25	L-W5
TGFPR25.4-6	5, 6	1.000	1	6.00	-	0.87	0.189	2.36	SHM6X1X25	L-W5

Use inserts TDC/TSC*, TDJ/TSJ*, TD XU, TDT, TDFT, see pages 1274 - 1288.

*Grooving only

EXTERNAL UNDERCUTTING HOLDERS



OD Undercutting

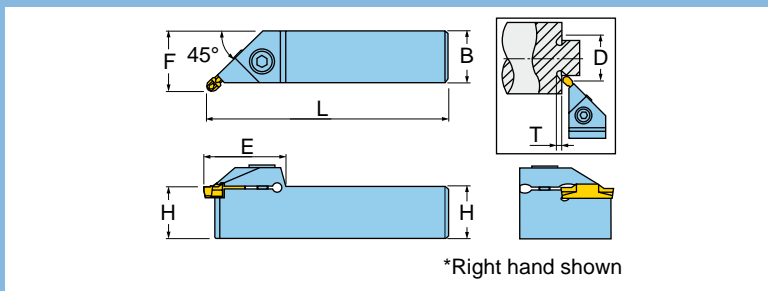

Designation	Insert Seat Size	H (inch)	B (inch)	L (inch)	F (inch)	E (inch)	Tmax (inch)	Dmin (inch)
TGEUL19-3	2, 3	0.750	0.75	5.00	0.92	1.18	0.110	1.26
TGEUL25.4-3	2, 3	1.000	1	6.00	1.11	1.18	0.110	1.26
TGEUL25.4-6	5, 6	1.000	1	6.00	1.14	1.38	0.130	1.34
TGEUR19-3	2, 3	0.750	0.75	5.00	0.92	1.18	0.110	1.26
TGEUR25.4-3	2, 3	1.000	1	6.00	1.11	1.18	0.110	1.26
TGEUR19-4	4	0.750	0.75	5.00	0.92	1.28	0.110	1.26
TGEUR25.4-6	5, 6	1.000	1	6.00	1.14	1.38	0.130	1.34

Use inserts TDT, TDIT, pages 1282 - 1289.

HARDWARE



Screw



Clamp Screw Wrench

TGEUL19-3	SHM5X0.8X20	L-W4
TGEUL25.4-3	SHM5X0.8X25	L-W4
TGEUL25.4-6	SHM6X1X25	L-W5
TGEUR19-3	SHM5X0.8X20	L-W4
TGEUR25.4-3	SHM5X0.8X25	L-W4
TGEUR19-4	SHM6X1X20	L-W5
TGEUR25.4-6	SHM6X1X25	L-W5

DEEP FACE GROOVING AND TURNING HOLDERS



Face Turning



Face Grooving

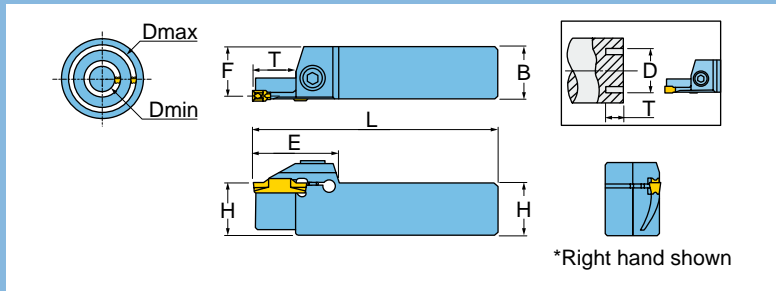

Designation	Ins. Seat Size	F (inch)	L (inch)	H (inch)	B (inch)	E (inch)	Tmax (inch)	Dmin (inch)	Dmax (inch)	Screw	Remark
TTF25.4-30-3	3	0.94	6.00	1.00	1.00	1.50	0.39	0.94	1.38	SHM5X0.8X25	L-W4
TTF25.4-35-3	3	0.94	6.00	1.00	1.00	1.50	0.39	1.14	1.57	SHM5X0.8X25	L-W4
TTF25.4-40-3	3	0.94	6.00	1.00	1.00	1.50	0.39	1.34	1.97	SHM5X0.8X25	L-W4
TTF25.4-50-3	3	0.94	6.00	1.00	1.00	1.50	0.59	1.73	2.36	SHM5X0.8X25	L-W4
TTF25.4-60-3	3	0.94	6.00	1.00	1.00	1.50	0.59	2.13	3.35	SHM5X0.8X25	L-W4
TTF25.4-30-4	4	0.93	6.00	1.00	1.00	1.30	0.39	0.87	1.57	SHM6X1X25	L-W5
TTF25.4-40-4	4	0.93	6.00	1.00	1.00	1.30	0.59	1.26	1.97	SHM6X1X25	L-W5
TTF25.4-50-4	4	0.93	6.00	1.00	1.00	1.30	0.59	1.65	2.36	SHM6X1X25	L-W5
TTF25.4-60-4	4	0.93	6.00	1.00	1.00	1.30	0.59	2.05	3.35	SHM6X1X25	L-W5
TTF25.4-60-6	6	0.93	6.00	1.00	1.00	1.46	0.79	1.89	3.35	SHM6X1X25	L-W5
TTF25.4-85-6	6	0.93	6.00	1.00	1.00	1.46	0.79	2.87	5.91	SHM6X1X25	L-W5
TTF25.4-150-6	6	0.93	6.00	1.00	1.00	1.46	0.79	5.43	9.84	SHM6X1X25	L-W5
TTFR25.4-30-3	3	0.94	6.00	1.00	1.00	1.50	0.39	0.94	1.38	SHM5X0.8X25	L-W4
TTFR25.4-35-3	3	0.94	6.00	1.00	1.00	1.50	0.39	1.14	1.57	SHM5X0.8X25	L-W4
TTFR25.4-40-3	3	0.94	6.00	1.00	1.00	1.50	0.39	1.34	1.97	SHM5X0.8X25	L-W4
TTFR25.4-50-3	3	0.94	6.00	1.00	1.00	1.50	0.59	1.73	2.36	SHM5X0.8X25	L-W4
TTFR25.4-60-3	3	0.94	6.00	1.00	1.00	1.50	0.59	2.13	3.35	SHM5X0.8X25	L-W4
TTFR25.4-30-4	4	0.93	6.00	1.00	1.00	1.30	0.39	0.87	1.57	SHM6X1X25	L-W5
TTFR25.4-40-4	4	0.93	6.00	1.00	1.00	1.30	0.59	1.26	1.97	SHM6X1X25	L-W5
TTFR25.4-50-4	4	0.93	6.00	1.00	1.00	1.30	0.59	1.65	2.36	SHM6X1X25	L-W5
TTFR25.4-60-4	4	0.93	6.00	1.00	1.00	1.30	0.59	2.05	3.35	SHM6X1X25	L-W5
TTFR25.4-60-6	6	0.93	6.00	1.00	1.00	1.46	0.79	1.89	3.35	SHM6X1X25	L-W5
TTFR25.4-85-6	6	0.93	6.00	1.00	1.00	1.46	0.79	2.87	5.91	SHM6X1X25	L-W5
TTFR25.4-150-6	6	0.93	6.00	1.00	1.00	1.46	0.79	5.43	9.84	SHM6X1X25	L-W5

Use inserts TDC/TSC*, TDJ/TSJ*, TDUX, TDT, TDFT, see pages 1274 - 1288.

*Grooving only

• INSERT INITIAL MIN. DIA. FOR FACE GROOVING

Insert	Min. Diameter	Remark
TDC/J 3	2.52	Use TDT or TDUX type if machining diameter is smaller than Dmin.
TDC/J 4	1.26	
TDC/J 5	1.97	
TDC/J 6	1.89	
TDT 3	1.73	
TDT 4	1.65	
TDT 5	1.97	
TDT 6	1.89	

DEEP FACE GROOVING AND TURNING HOLDERS (RENEWED TYPE)



Face Turning



Face Grooving

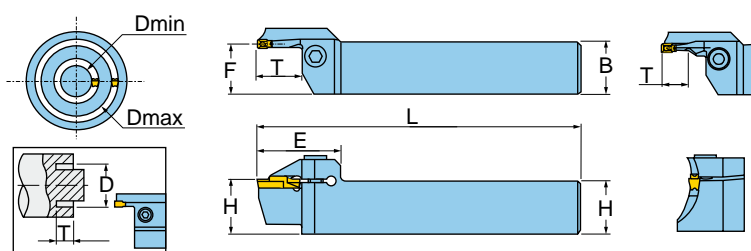

*Right hand shown

Designation	Ins. Seat Size	F (inch)	L (inch)	H (inch)	B (inch)	E (inch)	Tmax (inch)	Dmin (inch)	Dmax (inch)		
										Screw	Wrench
TTF25.4-30-3RN	3	0.94	6.00	1.00	1.00	1.50	0.39	0.94	1.38	SHM6X1X25	L-W5
TTF25.4-35-3RN	3	0.94	6.00	1.00	1.00	1.50	0.39	1.14	1.57	SHM6X1X25	L-W5
TTF25.4-40-3RN	3	0.94	6.00	1.00	1.00	1.50	0.39	1.34	1.97	SHM6X1X25	L-W5
TTF25.4-50-3RN	3	0.94	6.00	1.00	1.00	1.50	0.59	1.73	2.76	SHM6X1X25	L-W5
TTF25.4-70-3RN	3	0.94	6.00	1.00	1.00	1.50	0.59	2.52	3.94	SHM6X1X25	L-W5
TTF25.4-30-4RN	4	0.93	6.00	1.00	1.00	1.54	0.39	0.87	1.42	SHM6X1X25	L-W5
TTF25.4-36-4RN	4	0.93	6.00	1.00	1.00	1.54	0.79	1.10	1.65	SHM6X1X25	L-W5
TTF25.4-42-4RN	4	0.93	6.00	1.00	1.00	1.54	0.79	1.34	1.97	SHM6X1X25	L-W5
TTF25.4-50-4RN	4	0.93	6.00	1.00	1.00	1.54	0.79	1.65	2.76	SHM6X1X25	L-W5
TTF25.4-70-4RN	4	0.93	6.00	1.00	1.00	1.54	0.79	2.44	4.72	SHM6X1X25	L-W5
TTF25.4-120-4RN	4	0.93	6.00	1.00	1.00	1.54	0.79	4.41	7.87	SHM6X1X25	L-W5
TTF25.4-70-6RN	6	0.89	6.00	1.00	1.00	1.93	0.98	2.28	3.94	SHM8X1.25X25	L-W6
TTF25.4-100-6RN	6	0.89	6.00	1.00	1.00	1.93	0.98	3.46	7.09	SHM8X1.25X25	L-W6
TTF25.4-180-6RN	6	0.89	6.00	1.00	1.00	1.93	0.98	6.61	15.75	SHM8X1.25X25	L-W6
TTFR25.4-30-3RN	3	0.94	6.00	1.00	1.00	1.50	0.39	0.94	1.38	SHM6X1X25	L-W5
TTFR25.4-35-3RN	3	0.94	6.00	1.00	1.00	1.50	0.39	1.14	1.57	SHM6X1X25	L-W5
TTFR25.4-40-3RN	3	0.94	6.00	1.00	1.00	1.50	0.39	1.34	1.97	SHM6X1X25	L-W5
TTFR25.4-50-3RN	3	0.94	6.00	1.00	1.00	1.50	0.59	1.73	2.76	SHM6X1X25	L-W5
TTFR25.4-70-3RN	3	0.94	6.00	1.00	1.00	1.50	0.59	2.52	3.94	SHM6X1X25	L-W5
TTFR25.4-30-4RN	4	0.93	6.00	1.00	1.00	1.54	0.39	0.87	1.42	SHM6X1X25	L-W5
TTFR25.4-36-4RN	4	0.93	6.00	1.00	1.00	1.54	0.79	1.10	1.65	SHM6X1X16	L-W5
TTFR25.4-42-4RN	4	0.93	6.00	1.00	1.00	1.54	0.79	1.34	1.97	SHM6X1X25	L-W5
TTFR25.4-50-4RN	4	0.93	6.00	1.00	1.00	1.54	0.79	1.65	2.76	SHM6X1X25	L-W5
TTFR25.4-70-4RN	4	0.93	6.00	1.00	1.00	1.54	0.79	2.44	4.72	SHM6X1X25	L-W5
TTFR25.4-120-4RN	4	0.93	6.00	1.00	1.00	1.54	0.79	4.41	7.87	SHM6X1X25	L-W5
TTFR25.4-60-6RN	6	0.89	6.00	1.00	1.00	1.93	0.98	1.89	2.76	SHM8X1.25X25	L-W6
TTFR25.4-70-6RN	6	0.89	6.00	1.00	1.00	1.93	0.98	2.28	3.94	SHM8X1.25X25	L-W6
TTFR25.4-100-6RN	6	0.89	6.00	1.00	1.00	1.93	0.98	3.46	7.09	SHM8X1.25X25	L-W6
TTFR25.4-180-6RN	6	0.89	6.00	1.00	1.00	1.93	0.98	6.61	15.75	SHM8X1.25X25	L-W6

Use inserts TDC/TSC*, TDJ/TSJ*, TD XU, TDT, TDFT, see pages 1274 - 1288.

*Grooving only

• INSERT INITIAL MIN. DIA. FOR FACE GROOVING

Insert	Min. Diameter	Remark
TDC/J 3	2.52	Use TDT or TD XU type if machining diameter is smaller than Dmin.
TDC/J 4	1.26	
TDC/J 5	1.97	
TDC/J 6	1.89	
TDT 3	1.73	
TDT 4	1.65	
TDT 5	1.97	
TDT 6	1.89	

DEEP FACE GROOVING AND TURNING PERPENDICULAR HOLDERS AGAINST CENTER



Face Turning



Face Grooving

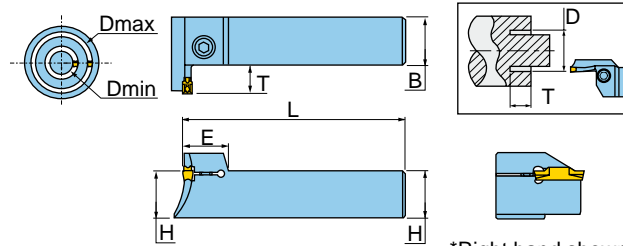

*Right hand shown

Designation	Ins. Seat Size	L (inch)	H (inch)	B (inch)	E (inch)	Tmax (inch)	Dmin (inch)	Dmax (inch)	Accessories	
									Screw	Clamp Screw Wrench
TTFPL25.4-30-3	3	6.00	1.00	1.00	0.71	0.39	0.94	1.38	SHM5X0.8X16	L-W4
TTFPL25.4-35-3	3	6.00	1.00	1.00	0.71	0.39	1.14	1.57	SHM5X0.8X16	L-W4
TTFPL25.4-40-3	3	6.00	1.00	1.00	0.71	0.39	1.34	1.97	SHM5X0.8X16	L-W4
TTFPL25.4-50-3	3	6.00	1.00	1.00	0.71	0.59	1.73	2.36	SHM5X0.8X16	L-W4
TTFPL25.4-60-3	3	6.00	1.00	1.00	0.71	0.59	2.13	3.35	SHM5X0.8X16	L-W4
TTFPL25.4-30-4	4	6.00	1.00	1.00	0.71	0.47	0.87	1.57	SHM6X1X25	L-W5
TTFPL25.4-50-4	4	6.00	1.00	1.00	0.71	0.59	1.65	2.36	SHM6X1X25	L-W5
TTFPL25.4-60-4	4	6.00	1.00	1.00	0.71	0.59	2.05	3.35	SHM6X1X25	L-W5
TTFPL25.4-60-6	6	6.00	1.00	1.00	0.87	0.79	1.89	3.35	SHM8X1.25X25	L-W6
TTFPL25.4-85-6	6	6.00	1.00	1.00	0.87	0.79	2.87	5.91	SHM8X1.25X25	L-W6
TTFPL25.4-150-6	6	6.00	1.00	1.00	0.87	0.79	5.43	9.84	SHM8X1.25X25	L-W6
TTFPR25.4-30-3	3	6.00	1.00	1.00	0.71	0.39	0.94	1.38	SHM5X0.8X25	L-W4
TTFPR25.4-35-3	3	6.00	1.00	1.00	0.71	0.39	1.14	1.57	SHM5X0.8X16	L-W4
TTFPR25.4-40-3	3	6.00	1.00	1.00	0.71	0.39	1.34	1.97	SHM5X0.8X16	L-W4
TTFPR25.4-50-3	3	6.00	1.00	1.00	0.71	0.59	1.73	2.36	SHM5X0.8X16	L-W4
TTFPR25.4-60-3	3	6.00	1.00	1.00	0.71	0.59	2.13	3.35	SHM5X0.8X25	L-W4
TTFPR25.4-30-4	4	6.00	1.00	1.00	0.71	0.47	0.87	1.57	SHM6X1X25	L-W5
TTFPR25.4-40-4	4	6.00	1.00	1.00	0.71	0.59	1.26	1.97	SHM6X1X25	L-W5
TTFPR25.4-50-4	4	6.00	1.00	1.00	0.71	0.59	1.65	2.36	SHM6X1X25	L-W5
TTFPR25.4-60-4	4	6.00	1.00	1.00	0.71	0.59	2.05	3.35	SHM6X1X25	L-W5
TTFPR25.4-60-6	6	6.00	1.00	1.00	0.87	0.79	1.89	3.35	SHM8X1.25X25	L-W6
TTFPR25.4-85-6	6	6.00	1.00	1.00	0.87	0.79	2.87	5.91	SHM8X1.25X25	L-W6
TTFPR25.4-150-6	6	6.00	1.00	1.00	0.87	0.79	5.43	9.84	SHM8X1.25X25	L-W6

Use inserts TDC/TSC*, TDJ/TSJ*, TD XU, TDT, TDFT, see pages 1274 - 1288.

*Grooving only

• INSERT INITIAL MIN. DIA. FOR FACE GROOVING

Insert	Min. Diameter	Remark
TDC/J 3	2.52	Use TDFT or TD XU type if machining diameter is smaller than Dmin.
TDC/J 4	1.26	
TDC/J 5	1.97	
TDC/J 6	1.89	
TDT 3	1.73	
TDT 4	1.65	
TDT 5	1.97	
TDT 6	1.89	

INTERNAL TURNING, GROOVING AND PROFILING HOLDERS



ID Profiling



ID Turning



ID Grooving

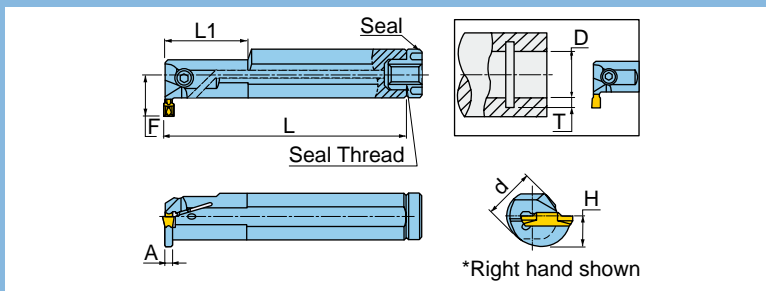

Designation	Insert Seat Size	d (inch)	A (inch)	H (inch)	F (inch)	L (inch)	L1 (inch)	Tmax (inch)	Dmin (inch)	Accessories		
										Screw	Wrench	Seal
TTIL16-2C	2	0.63	0.063	0.30	0.65	4.9	-	0.33	0.98	SHM5X0.8X10	L-W4	PL16
TTIL19-3C	3	0.75	0.083	0.33	0.62	6.5	1.570	0.26	0.98	SHM5X0.8X20	L-W4	PL20
TTIL25.4-3C	3	1.00	0.083	0.45	0.69	8.0	1.570	0.23	0.98	SHM5X0.8X16	L-W4	PL25
TTIL19-4C	4	0.75	0.114	0.33	0.62	6.5	1.570	0.26	0.98	SHM5X0.8X20	L-W4	PL20
TTIL25.4-4C	4	1.00	0.114	0.45	0.69	8.0	1.570	0.23	0.98	SHM5X0.8X25	L-W4	PL25
TTIL31.7-4C	4	1.25	0.114	0.55	0.82	10.0	2.360	0.26	1.26	SHM5X0.8X16	L-W4	PL32
TTIL25.4-5C	5	1.00	0.154	0.45	0.68	8.0	1.570	0.26	1.26	SHM5X0.8X25	L-W4	PL25
TTIL31.7-5C	5	1.25	0.154	0.55	0.82	10.0	2.360	0.26	1.26	SHM6X1X25	L-W5	PL32
TTIL31.7-6C	6	1.25	0.193	0.55	0.82	10.0	2.360	0.26	1.26	SHM6X1X25	L-W5	PL32
TTIL31.7-8C	8	1.25	0.232	0.57	0.84	10.0	2.360	0.26	1.46	SHM6X1X25	L-W5	PL32
TTIL38.1-8C	8	1.50	0.232	0.70	1.02	12.0	2.560	0.26	1.65	SHM6X1X25	L-W5	PL40
TTIR16-2C	2	0.63	0.063	0.30	0.65	4.9	-	0.33	0.98	SHM5X0.8X10	L-W4	PL16
TTIR19-2C	2	0.75	0.063	0.33	0.62	6.3	1.570	0.24	0.98	SHM5X0.8X12	L-W4	PL20
TTIR25.4-2C	2	1.00	0.063	0.45	0.69	8.0	1.570	0.20	0.98	SHM5X0.8X16	L-W4	PL25
TTIR19-3C	3	0.75	0.083	0.33	0.62	6.5	1.570	0.26	0.98	SHM5X0.8X12	L-W4	PL20
TTIR25.4-3C	3	1.00	0.083	0.45	0.69	8.0	1.570	0.23	0.98	SHM5X0.8X16	L-W4	PL25
TTIR19-4C	4	0.75	0.114	0.33	0.62	6.5	1.570	0.26	0.98	SHM5X0.8X20	L-W4	PL20
TTIR25.4-4C	4	1.00	0.114	0.45	0.69	8.0	1.570	0.23	0.98	SHM5X0.8X25	L-W4	PL25
TTIR31.7-4C	4	1.25	0.114	0.55	0.82	10.0	2.360	0.26	1.26	SHM5X0.8X16	L-W4	PL32
TTIR25.4-5C	5	1.00	0.154	0.45	0.68	8.0	1.570	0.26	1.26	SHM6X1X16	L-W5	PL25
TTIR31.7-5C	5	1.25	0.154	0.55	0.82	10.0	2.360	0.26	1.26	SHM6X1X25	L-W5	PL32
TTIR31.7-6C	6	1.25	0.193	0.55	0.82	10.0	2.360	0.26	1.26	SHM6X1X20	L-W5	PL32
TTIR31.7-8C	8	1.25	0.232	0.57	0.84	10.0	2.360	0.26	1.46	SHM6X1X25	L-W5	PL32
TTIR38.1-8C	8	1.50	0.232	0.70	1.02	12.0	2.560	0.26	1.65	SHM6X1X25	L-W5	PL40

Use inserts TDC/TSC*, TDJ/TSJ*, TDXU, TDT, TDIT, see pages 1274 - 1290.

*Grooving only

• INSERT INITIAL MIN. DIA. FOR FACE GROOVING

Insert	Min. Diameter	Remark
TDC/J 2	1.57	Use TDTF or TDXU type if machining diameter is smaller than Dmin.
TDC/J 3	1.97	
TDC/J 4	1.97	
TDC/J 5	2.36	
TDC/J 6	2.36	
TDT 3	1.57	
TDT 4	1.57	
TDT 5	1.97	
TDT 6	1.97	
TDT 8	2.60	

INTERNAL UNDERCUTTING HOLDERS



ID Undercutting

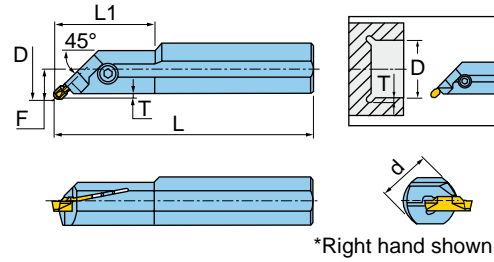

Designation	Insert Seat Size	d (inch)	H (inch)	F (inch)	L (inch)	L1 (inch)	Tmax (inch)	Dmin (inch)	Screw	Wrench
TGIUL19-3	3	0.750	0.35	0.50	6.50	-	0.11	1.50	SHM5X0.8X12	L-W4
TGIUL25.4-3	3	1.000	0.45	0.58	8.00	1.57	0.11	1.50	SHM5X0.8X25	L-W4
TGIUR19-3	3	0.750	0.35	0.50	6.50	-	0.11	1.50	SHM5X0.8X12	L-W4
TGIUR25.4-3	3	1.000	0.45	0.58	8.00	1.57	0.11	1.50	SHM5X0.8X16	L-W4
TGIUL25.4-4	4	1.000	0.45	0.59	8.00	1.57	0.11	1.81	SHM5X0.8X16	L-W4
TGIUR25.4-4	4	1.000	0.45	0.59	8.00	1.57	0.11	1.81	SHM5X0.8X16	L-W4
TGIUL25.4-6	6	1.000	0.45	0.60	8.00	-	0.11	1.81	SHM6X1X16	L-W5
TGIUR25.4-6	6	1.000	0.45	0.60	8.00	-	0.11	1.81	SHM6X1X16	L-W5

Use inserts TDT, TDIT, pages 1282 - 1289.

INTERNAL TURNING HOLDERS - INCH



ID Turning

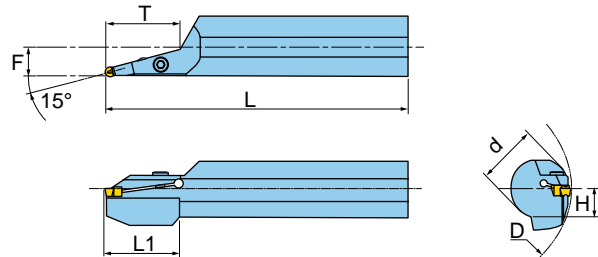

Designation	Insert Seat Size	d (inch)	H (inch)	F (inch)	L (inch)	L1 (inch)	Tmax (inch)	Dmin (inch)	Screw	Wrench
TGIUL38.1-6-15A	6	1.500	0.70	0.71	12.00	1.97	1.97	6.30	SHM6X1X25	L-W5
TGIUR38.1-6-15A	6	1.500	0.70	0.71	12.00	1.97	1.97	6.30	SHM6X1X25	L-W5
TGIUL38.1-8-15A	8	1.500	0.70	0.69	12.00	2.36	3.27	6.30	SHM6X1X25	L-W5
TGIUR38.1-8-15A	8	1.500	0.70	0.69	12.00	2.36	3.27	6.30	SHM6X1X25	L-W5

Use inserts TDT, TDIT, pages 1282 - 1289.

INTERNAL TURNING HOLDERS WITH COOLANT - METRIC



ID Turning

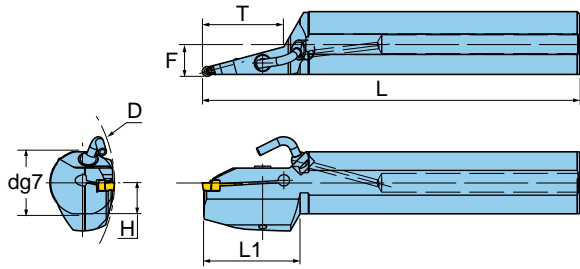

Designation	Insert Seat Size	d (mm)	H (mm)	F (mm)	L (mm)	L1 (mm)	Tmax (mm)	Dmin (mm)
TGIUL40-6C-15A	6	40.0	19.0	19.8	320.0	70.0	50.0	160.0
TGIUL50-6C-15A	6	50.0	23.5	25.2	350.0	85.0	85.0	200.0
TGIUR40-6C-15A	6	40.0	19.0	19.8	320.0	70.0	50.0	2.0
TGIUR50-6C-15A	6	50.0	23.5	25.2	350.0	85.0	85.0	200.0
TGIUL50-8C-15A	8	50.0	23.5	25.9	350.0	85.0	85.0	200.0
TGIUR40-8C-15A	8	40.0	19.0	20.2	320.0	100.0	83.0	160.0

Use inserts TDT, TDIT, pages 1282 - 1289.

HARDWARE



Screw

SHM6X1X25



Wrench

L-W5



Seal

PL40



Nozzle

NZ125



Coolant Pipe

NZP5

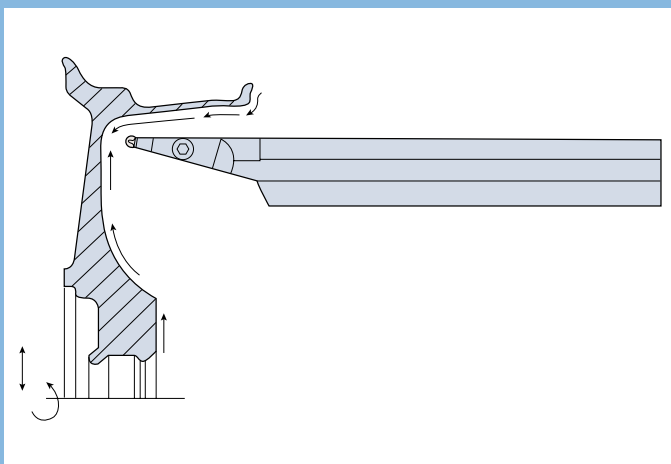



INTERNAL TURNING HOLDERS FOR ALUMINUM WHEELS MACHINING

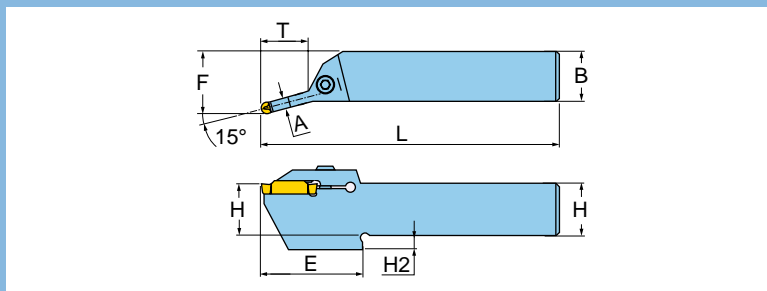

ID Turning



Designation	Insert Seat Size	H (mm)	B (mm)	L (mm)	E (mm)	F (mm)	A (mm)	H2 (mm)	Tmax (mm)		
TTEL2525-6-15A	6	25	25	150	55	30	4.9	7	25	SHM6X1X25	L-W5
TTER2525-6-15A	6	25	25	150	55	30	4.9	7	25	SHM6X1X25	L-W5
TTEL2525-8-15A	8	25	25	150	57	30	5.9	7	30	SHM6X1X25	L-W5
TTER2525-8-15A	8	25	25	150	57	30	5.9	7	30	SHM6X1X25	L-W5

Use inserts TDA/TSA, page 1291.

T-CLAMP ULTRA BLADES FOR PARTING AND GROOVING



OD Grooving



Parting

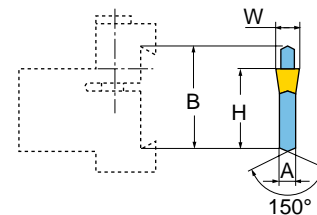
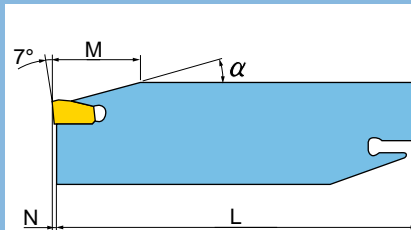

Designation	Insert Seat Size	W Range	B (inch)	L (inch)	DiaMax (inch)	H (inch)	a (Deg.)	A (inch)	Nose Length (inch)	M (inch)
TH101191	1	.053-.098	0.75	3.38	1.25	0.62	21	0.05	0.034	0.446
TH101261	1	.053-.098	1.02	4.33	1.37	0.84	21	0.05	0.034	0.586
TH101321	1	.053-.098	1.25	5.90	1.50	0.98	21	0.05	0.034	0.853
TH101192	2	.073-.098	0.75	3.38	1.57	0.62	20	0.06	0.034	0.452
TH101262	2	.073-.098	1.02	4.33	2.00	0.84	20	0.06	0.034	0.592
TH101322	2	.073-.098	1.25	5.90	2.00	0.98	20	0.06	0.034	0.827
TH101263	4	.106-.154	1.02	4.33	3.00	0.84	20	0.09	0.041	0.707
TH101323	4	.106-.154	1.25	5.90	4.00	0.98	20	0.09	0.041	1.039
TH101264	4	.146-.185	1.02	4.33	3.15	0.84	20	0.13	0.041	0.629
TH101324	4	.146-.185	1.25	5.90	4.00	0.98	20	0.13	0.041	1.006
TH101265	4	.177-.217	1.02	4.33	3.15	0.84	20	0.16	0.041	0.691
TH101325	4	.177-.217	1.25	5.90	5.00	0.98	20	0.16	0.041	1.006
TH101326	6	.224-.256	1.25	5.90	5.00	0.98	20	0.21	0.041	1.006

Use inserts TIMC, TIMJ, TIPV, [pages 1292 - 1297](#).

HARDWARE



Insert Extractor

TH101191	DR-0032
TH101261	DR-0032
TH101321	DR-0032
TH101192	DR-0032
TH101262	DR-0032
TH101322	DR-0032
TH101263	DR-0031
TH101323	DR-0031
TH101264	DR-0031
TH101324	DR-0031
TH101265	DR-0031
TH101325	DR-0031
TH101326	DR-0031

T-CLAMP ULTRA TOOL HOLDERS FOR PARTING AND GROOVING

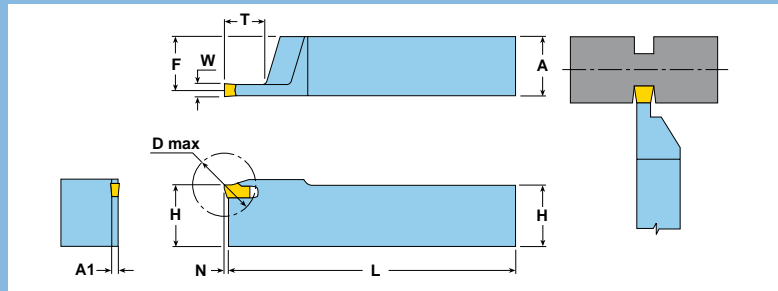

Designation	Insert Seat Size	W Range (inch)	F (inch)	L (inch)	D max (inch)	H (inch)	A (inch)	T (inch)	N (inch)	N (inch)	A1 (inch)
THL201103	4	.106-.154	0.590	4.5	1.370	0.625	0.625	0.37	0.041	0.041	0.094
THL201104	4	.146-.185	0.562	4.5	1.500	0.625	0.625	0.43	0.041	0.041	0.126
THL201123	4	.106-.154	0.700	4.5	1.570	0.750	0.750	0.64	0.041	0.041	0.094
THL201125	4	.177-.217	0.671	4.5	2.000	0.750	0.750	0.76	0.041	0.041	0.161
THL201166	6	.224-.256	0.900	6.0	3.000	1.000	1.000	1.30	0.041	0.041	0.189
THL201204	4	.146-.185	1.185	7.0	2.750	1.250	1.250	1.10	0.041	0.041	0.126
THR201082	2	.073-.098	0.462	4.3	1.250	0.500	0.500	0.41	0.034	0.034	0.066
THR201083	4	.106-.154	0.458	4.3	1.250	0.500	0.500	0.38	0.041	0.041	0.094
THR201166	6	.224-.256	0.900	6.0	3.000	1.000	1.000	1.30	0.041	0.041	0.189
THR201203	4	.106-.154	1.203	7.0	2.200	1.250	1.250	0.92	0.041	0.041	0.094
THL201062	2	.073-.098	0.341	3.0	1.125	0.375	0.375	0.35	0.034	0.034	0.066
THL201102	2	.073-.098	0.593	4.5	1.250	0.625	0.625	0.41	0.034	0.034	0.066
THL201122	2	.073-.098	0.717	4.5	1.375	0.750	0.750	0.38	0.034	0.034	0.066
THL201083	4	.106-.154	0.458	4.3	1.250	0.500	0.500	0.38	0.041	0.041	0.094
THL201163	4	.106-.154	0.953	6.0	2.200	1.000	1.000	0.93	0.041	0.041	0.094
THL201124	4	.146-.185	0.686	4.5	2.000	0.750	0.750	0.75	0.041	0.041	0.126
THL201164	4	.146-.185	0.935	6.0	2.500	1.000	1.000	1.06	0.041	0.041	0.126
THL201165	4	.177-.217	0.921	6.0	3.000	1.000	1.000	1.30	0.041	0.041	0.161
THL201206	6	.224-.256	1.150	7.0	3.150	1.250	1.250	1.30	0.041	0.041	0.189
THR201062	2	.073-.098	0.341	3.0	1.125	0.375	0.375	0.35	0.034	0.034	0.066
THR201102	2	.073-.098	0.593	4.5	1.250	0.625	0.625	0.41	0.034	0.034	0.066
THR201122	2	.073-.098	0.717	4.5	1.375	0.750	0.750	0.38	0.034	0.034	0.066
THR201103	4	.106-.154	0.590	4.5	1.370	0.625	0.625	0.37	0.041	0.041	0.094
THR201123	4	.106-.154	0.700	4.5	1.570	0.750	0.750	0.64	0.041	0.041	0.094
THR201163	4	.106-.154	0.953	6.0	2.200	1.000	1.000	0.93	0.041	0.041	0.094
THR201124	4	.146-.185	0.686	4.5	2.000	0.750	0.750	0.75	0.041	0.041	0.126
THR201164	4	.146-.185	0.935	6.0	2.500	1.000	1.000	1.06	0.041	0.041	0.126
THR201204	4	.146-.185	1.185	7.0	2.750	1.250	1.250	1.10	0.041	0.041	0.126
THR201125	4	.177-.217	0.671	4.5	2.000	0.750	0.750	0.76	0.041	0.041	0.161
THR201165	4	.177-.217	0.921	6.0	3.000	1.000	1.000	1.30	0.041	0.041	0.161
THR201206	6	.224-.256	1.150	7.0	3.150	1.250	1.250	1.30	0.041	0.041	0.189

T-CLAMP ULTRA TOOL HOLDERS FOR PARTING AND GROOVING



OD Grooving



Parting

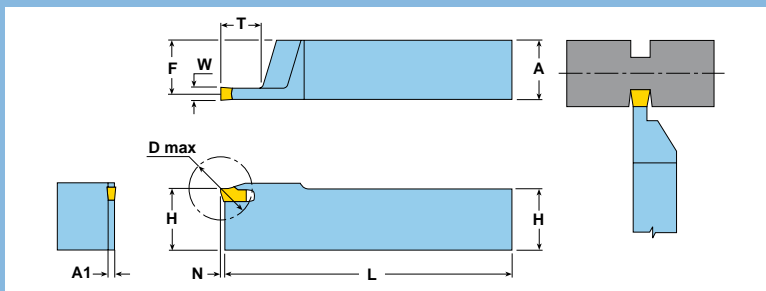

HARDWARE



Insert Extractor

THL201103	DR-0031
THL201104	DR-0031
THL201123	DR-0031
THL201125	DR-0031
THL201166	DR-0031
THL201204	DR-0031
THR201082	DR-0032
THR201083	DR-0031
THR201166	DR-0031
THR201203	DR-0031
THL201062	DR-0032
THL201102	DR-0032
THL201122	DR-0032
THL201083	DR-0031
THL201163	DR-0031
THL201124	DR-0032
THL201164	DR-0031
THL201165	DR-0031
THL201206	DR-0031
THR201062	DR-0032
THR201102	DR-0032
THR201122	DR-0032
THR201103	DR-0031
THR201123	DR-0031
THR201163	DR-0031
THR201124	DR-0031
THR201164	DR-0031
THR201204	DR-0031
THR201125	DR-0031
THR201165	DR-0031
THR201206	DR-0031

Use inserts TIMC, TIMJ, TIPV, pages 1292 - 1297.

T-CLAMP ULTRA TOOL HOLDERS FOR TURNING AND GROOVING

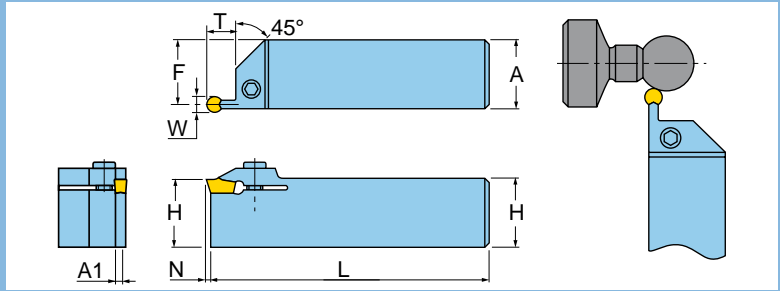

Designation	Insert Seat Size	W Range (inch)	F (inch)	H (inch)	L (inch)	Tmax (inch)	Nose Length (inch)	A1 (inch)
THL211062	2	.073-.098	0.342	0.375	4.00	0.340	0.034	0.066
THL211082	2	.073-.098	0.467	0.500	4.00	0.340	0.034	0.066
THL211063	4	.110-.142	0.328	0.375	4.00	0.390	0.041	0.094
THL211103	4	.110-.142	0.578	0.625	4.00	0.390	0.041	0.094
THL211123	4	.110-.142	0.703	0.750	5.00	0.390	0.041	0.094
THL211163	4	.110-.142	0.953	1.000	6.00	0.390	0.041	0.094
THL211203	4	.110-.142	1.203	1.250	7.00	0.390	0.041	0.094
THL211124	4	.142-.181	0.687	0.750	5.00	0.510	0.041	0.126
THL211164	4	.142-.181	0.937	1.000	6.00	0.510	0.041	0.126
THL211204	4	.142-.181	1.187	1.250	7.00	0.510	0.041	0.126
THL211165	4	.177-.217	0.919	1.000	6.00	0.510	0.041	0.161
THL211205	4	.177-.217	1.169	1.250	7.00	0.510	0.041	0.161
THL211166	6	.213-.256	0.906	1.000	6.00	0.630	0.041	0.189
THL211206	6	.213-.256	1.156	1.250	7.00	0.630	0.041	0.189
THR211062	2	.073-.098	0.342	0.375	4.00	0.340	0.034	0.066
THR211082	2	.073-.098	0.467	0.500	4.00	0.340	0.034	0.066
THR211063	4	.110-.142	0.328	0.375	4.00	0.390	0.041	0.094
THR211083	4	.110-.142	0.453	0.500	4.00	0.390	0.041	0.094
THR211103	4	.110-.142	0.578	0.625	4.00	0.390	0.041	0.094
THR211123	4	.110-.142	0.703	0.750	5.00	0.390	0.041	0.094
THR211163	4	.110-.142	0.953	1.000	6.00	0.390	0.041	0.094
THR211203	4	.110-.142	1.203	1.250	7.00	0.390	0.041	0.094
THR211104	4	.142-.181	0.562	0.625	4.00	0.510	0.041	0.126
THR211124	4	.142-.181	0.687	0.750	5.00	0.510	0.041	0.126
THR211164	4	.142-.181	0.937	1.000	6.00	0.510	0.041	0.126
THR211204	4	.142-.181	1.187	1.250	7.00	0.510	0.041	0.126
THR211165	4	.177-.217	0.919	1.000	6.00	0.510	0.041	0.161
THR211205	4	.177-.217	1.169	1.250	7.00	0.510	0.041	0.161
THR211166	6	.213-.256	0.906	1.000	6.00	0.630	0.041	0.189

T-CLAMP ULTRA TOOL HOLDERS FOR TURNING AND GROOVING



OD Profiling



OD Turning



OD Grooving



Parting

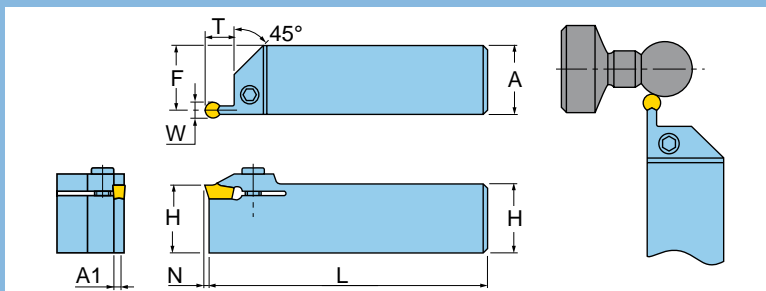

HARDWARE



Insert Screw



THL211062	SR-76-1021	T20
THL211082	SR-76-1022	T20
THL211063	SR-76-1021	T20
THL211103	M5X20DIN912	L-W4
THL211123	M5X20DIN912	L-W4
THL211163	M5X25DIN912	L-W4
THL211203	M5X25DIN912	L-W4
THL211124	M5X25DIN912	L-W4
THL211164	M5X25DIN912	L-W4
THL211204	M5X25DIN912	L-W4
THL211165	M5X25DIN912	L-W4
THL211205	M5X25DIN912	L-W4
THL211166	M5X25DIN912	L-W4
THL211206	M5X25DIN912	L-W4
THR211062	SR-76-1021	T20
THR211082	SR-76-1022	T20
THR211063	SR-76-1021	T20
THR211083	SR-76-1022	T20
THR211103	M5X20DIN912	L-W4
THR211123	M5X20DIN912	L-W4
THR211163	M5X25DIN912	L-W4
THR211203	M5X20DIN912	L-W4
THR211104	M5X20DIN912	L-W4
THR211124	M5X20DIN912	L-W4
THR211164	M5X25DIN912	L-W4
THR211204	M5X25DIN912	L-W4
THR211165	M5X25DIN912	L-W4
THR211205	M5X25DIN912	L-W4
THR211166	M5X25DIN912	L-W4

Use inserts TIMC*, TIMJ*, TIPV, [pages 1292 - 1297](#).

*Grooving only

T-CLAMP ULTRA TOOL HOLDERS FOR ID TURNING AND GROOVING

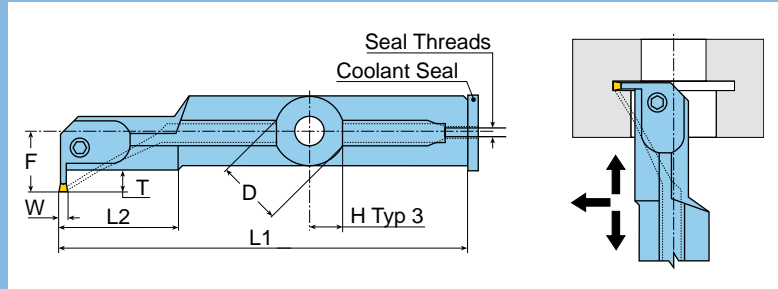

Designation	Insert Seat Size	W Range (inch)	Tmax (inch)	Min. Bore Dia.	D (inch)	F (inch)	H (inch)	C (inch)	L1 (inch)	L2 (inch)
THL61916C078	2	.073-.098	0.275	1.690	1.000	0.803	0.459	0.012	8.000	2.000
THL61920C078	2	.073-.098	0.315	1.690	1.250	0.976	0.570	0.012	10.000	2.500
THL61924C078	2	.073-.098	0.354	1.690	1.500	1.138	0.670	0.012	12.000	3.000
THL61916C118	4	.110-.142	0.315	2.050	1.000	0.827	0.459	0.020	8.000	2.000
THL61920C118	4	.110-.142	0.390	2.050	1.250	1.043	0.570	0.020	10.000	2.250
THL61924C118	4	.110-.142	0.461	2.050	1.500	1.240	0.670	0.020	12.000	2.500
THL61924C157	4	.142-.181	0.461	2.050	1.500	1.240	0.670	0.020	12.000	2.000
THL61920C197	4	.177-.217	0.390	2.050	1.250	1.043	0.570	0.020	10.000	1.750
THL61924C236	6	.213-.256	0.620	2.130	1.500	1.398	0.670	0.020	12.000	2.000
THR61916C078	2	.073-.098	0.275	1.690	1.000	0.803	0.459	0.012	8.000	2.000
THR61924C078	2	.073-.098	0.354	1.690	1.500	1.138	0.670	0.012	12.000	3.000
THR61916C118	4	.110-.142	0.315	2.050	1.000	0.827	0.459	0.020	8.000	2.000
THR61920C118	4	.110-.142	0.390	2.050	1.250	1.043	0.570	0.020	10.000	2.250
THR61924C118	4	.110-.142	0.461	2.050	1.500	1.240	0.670	0.020	12.000	2.500
THR61920C157	4	.142-.181	0.390	2.050	1.250	1.043	0.570	0.020	10.000	2.000
THR61924C157	4	.142-.181	0.461	2.050	1.500	1.240	0.670	0.020	12.000	2.000
THR61916C157	4	.142-.181	0.315	2.050	1.000	0.827	0.459	0.020	8.000	2.000
THR61920C197	4	.177-.217	0.390	2.050	1.250	1.043	0.570	0.020	10.000	1.750
THR61924C197	4	.177-.217	0.461	2.050	1.500	1.240	0.670	0.020	12.000	1.750
THR61924C236	6	.213-.256	0.620	2.130	1.500	1.398	0.670	0.020	12.000	2.000

T-CLAMP ULTRA TOOL HOLDERS FOR ID TURNING AND GROOVING



ID Turning

ID Grooving

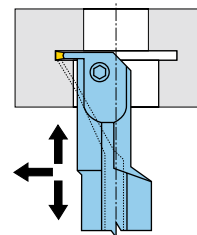
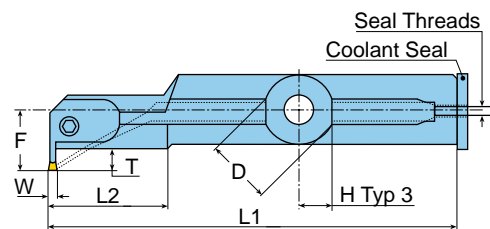

HARDWARE



Insert Screw



Seal



Wrench

THL61916C078	SR-76-1021	PL-25	T20
THL61920C078	SR-76-1021	PL32	T20
THL61924C078	SR-76-1022	PL40	T20
THL61916C118	SR-76-1022	PL-25	T20
THL61920C118	SR-76-1022	PL32	T20
THL61924C118	SR-76-1022	PL40	T20
THL61924C157	SR-76-1022	PL40	T20
THL61920C197	SR-76-1022	PL32	T20
THL61924C236	SR-76-1022	PL40	T20
THR61916C078	SR-76-1021	PL-25	T20
THR61924C078	SR-76-1022	PL40	T20
THR61916C118	SR-76-1022	PL-25	T20
THR61920C118	SR-76-1022	PL32	T20
THR61924C118	SR-76-1022	PL40	T20
THR61920C157	SR-76-1022	PL32	T20
THR61924C157	SR-76-1022	PL40	T20
THR61916C157	SR-76-1022	PL-25	T20
THR61920C197	SR-76-1022	PL32	T20
THR61924C197	SR-76-1022	PL40	T20
THR61924C236	SR-76-1022	PL150	T20

Use inserts TIMC*, TIMJ*, TIPV, pages 1292 - 1297.

*Grooving only

TRIPLE CORNER INSERT FOR SHALLOW GROOVING



OD Grooving

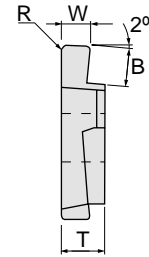
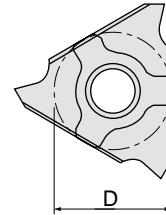

Designation	Hand	W +/- .004 (inch)	B (inch)	R (inch)	D (inch)	T (inch)	Grade	CT3000	PV3030	TT9030
TTG22125L	Left	0.049	0.079	0.008	0.500	0.187	●●●			
TTG22150L	Left	0.059	0.079	0.008	0.500	0.187	●●●			
TTG22185L	Left	0.073	0.138	0.008	0.500	0.187	●●●			
TTG22200L	Left	0.079	0.138	0.008	0.500	0.187	●●●			
TTG22250L	Left	0.098	0.157	0.012	0.500	0.187	●●●			
TTG22300L	Left	0.118	0.157	0.012	0.500	0.187	●●●			
TTG22330L	Left	0.13	0.157	0.012	0.500	0.187	●●●			
TTG22350L	Left	0.138	0.197	0.012	0.500	0.187	●●●			
TTG22400L	Left	0.157	0.197	0.018	0.500	0.187	●●●			
TTG22430L	Left	0.169	0.197	0.016	0.500	0.187	●●●			
TTG22470L	Left	0.185	0.197	0.016	0.500	0.187	●●●			
TTG22125R	Right	0.049	0.079	0.008	0.500	0.187	●●●			
TTG22150R	Right	0.059	0.079	0.008	0.500	0.187	●●●			
TTG22185R	Right	0.073	0.138	0.008	0.500	0.187	●●●			●
TTG22200R	Right	0.079	0.138	0.008	0.500	0.187	●●●			
TTG22250R	Right	0.098	0.157	0.012	0.500	0.187	●●●			
TTG22300R	Right	0.118	0.157	0.012	0.500	0.187	●●●		●	
TTG22330R	Right	0.13	0.157	0.012	0.500	0.187	●●●			
TTG22350R	Right	0.138	0.197	0.012	0.500	0.187	●●●			
TTG22400R	Right	0.157	0.197	0.018	0.500	0.187	●●●			
TTG22430R	Right	0.169	0.197	0.016	0.500	0.187	●●●			
TTG22470R	Right	0.185	0.197	0.016	0.500	0.187	●●●			

Use holder TGTER/L, page 1340.

● = P ● = M ● = K ● = N ● = S ○ = H

TOCLAMP SERIES TTG (SCREW CLAMP)

TRIPLE CORNER INSERT FOR SHALLOW GROOVING



OD Grooving

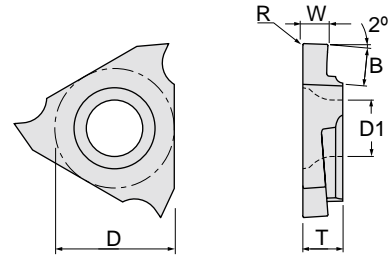

Designation	Hand	W +/- .0001 (inch)	B (inch)	R (inch)	D (inch)	T (inch)	D1 (inch)	Grade		
								CT3000	TT9030	
TTG32L03007R05-C	Left	0.012	0.028	0.002	0.375	0.125	0.177			
TTG32L05012R05-C	Left	0.020	0.047	0.002	0.375	0.125	0.177			
TTG32L07520R10-C	Left	0.030	0.079	0.004	0.375	0.125	0.177			
TTG32L10020R10-C	Left	0.039	0.079	0.004	0.375	0.125	0.177			
TTG32L12520R10-C	Left	0.049	0.079	0.004	0.375	0.125	0.177			
TTG32L15020R10-C	Left	0.059	0.079	0.004	0.375	0.125	0.177			●
TTG32L17520R10-C	Left	0.069	0.079	0.004	0.375	0.125	0.177			●
TTG32L20025R10-C	Left	0.079	0.098	0.004	0.375	0.125	0.177			
TTG32L25025R10-C	Left	0.098	0.098	0.004	0.375	0.125	0.177			●
TTG43L12535R20-C	Left	0.049	0.138	0.008	0.500	0.187	0.217			
TTG43L15035R20-C	Left	0.059	0.138	0.008	0.500	0.187	0.217			
TTG43L17535R20-C	Left	0.069	0.138	0.008	0.500	0.187	0.217			
TTG43L20035R20-C	Left	0.079	0.138	0.008	0.500	0.187	0.217			
TTG43L25040R30-C	Left	0.098	0.157	0.012	0.500	0.187	0.217			
TTG43L30040R30-C	Left	0.118	0.157	0.012	0.500	0.187	0.217			
TTG43L35050R30-C	Left	0.138	0.197	0.012	0.500	0.187	0.217			
TTG43L40050R40-C	Left	0.157	0.197	0.016	0.500	0.187	0.217			●
TTG32R03007R05-C	Right	0.012	0.028	0.002	0.375	0.125	0.177			●
TTG32R05012R05-C	Right	0.020	0.047	0.002	0.375	0.125	0.177			●
TTG32R07520R10-C	Right	0.030	0.079	0.004	0.375	0.125	0.177			●
TTG32R10020R10-C	Right	0.039	0.079	0.004	0.375	0.125	0.177			●
TTG32R12520R10-C	Right	0.049	0.079	0.004	0.375	0.125	0.177			●
TTG32R15020R10-C	Right	0.059	0.079	0.004	0.375	0.125	0.177			●
TTG32R17520R10-C	Right	0.069	0.079	0.004	0.375	0.125	0.177			●
TTG32R20025R10-C	Right	0.079	0.098	0.004	0.375	0.125	0.177			●
TTG32R25025R10-C	Right	0.098	0.098	0.004	0.375	0.125	0.177			●
TTG43R12535R20-C	Right	0.049	0.138	0.008	0.500	0.187	0.217			●
TTG43R15035R20-C	Right	0.059	0.138	0.008	0.500	0.187	0.217			●
TTG43R17535R20-C	Right	0.069	0.138	0.008	0.500	0.187	0.217			●
TTG43R20035R20-C	Right	0.079	0.138	0.008	0.500	0.187	0.217			●
TTG43R25040R30-C	Right	0.098	0.157	0.012	0.500	0.187	0.217			
TTG43R30040R30-C	Right	0.118	0.157	0.012	0.500	0.187	0.217			●
TTG43R35050R30-C	Right	0.138	0.197	0.012	0.500	0.187	0.217			
TTG43R40050R40-C	Right	0.157	0.197	0.016	0.500	0.187	0.217			●

Use holder TGTER/L, page 1341.

● = P ● = M ● = K ● = N ● = S ○ = H

TOCLAMP SERIES TGTER/L (LEVER LOCK)

EXTERNAL SHALLOW GROOVING HOLDERS



OD Grooving

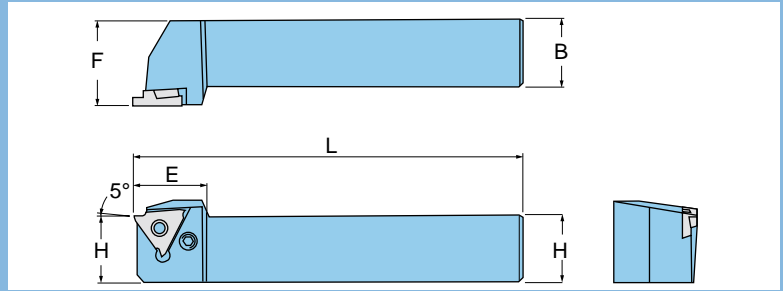

Designation	H (inch)	B (inch)	L (inch)	E (inch)	F (inch)
TGTEL19-4-20	0.75	0.75	5.00	1.100	1.000
TGTEL19-4-33	0.75	0.75	5.00	1.100	1.000
TGTEL25.4-4-20	1.00	1.00	6.00	1.100	1.250
TGTEL25.4-4-33	1.00	1.00	6.00	1.100	1.25
TGTER19-4-20	0.75	0.75	5.00	1.100	1.000
TGTER19-4-33	0.75	0.75	5.00	1.100	1.000
TGTER25.4-4-20	1.00	1.00	6.00	1.100	1.250
TGTER25.4-4-33	1.00	1.00	6.00	1.100	1.250

Use inserts TTG, page 1338.

HARDWARE



Accepts Insert Series



Lever



Lever Screw



Snap Ring



Wrench

TGTEL19-4-20	TTG22125 - TTG22200L	LCL4B	LCS4B-T	LSR4B	L-W2.5
TGTEL19-4-33	TTG22250 - TTG22330L	LCL4B	LCS4B-T	LSR4B	L-W2.5
TGTEL25.4-4-20	TTG22125 - TTG22200L	LCL4B	LCS4B-T	LSR4B	L-W2.5
TGTEL25.4-4-33	TTG22125 - TTG22200L	LCL4B	LCS4B-T	LSR4B	L-W2.5
TGTER19-4-20	TTG22125 - TTG22200R	LCL4B	LCS4B-T	LSR4B	L-W2.5
TGTER19-4-33	TTG22125 - TTG22200R	LCL4B	LCS4B-T	LSR4B	L-W2.5
TGTER25.4-4-20	TTG22125 - TTG22200R	LCL4B	LCS4B-T	LSR4B	L-W2.5
TGTER25.4-4-33	TTG22250 - TTG22320R	LCL4B	LCS4B-T	LSR4B	L-W2.5

TOCLAMP SERIES TGTER/L (SCREW CLAMP)

EXTERNAL SHALLOW GROOVING HOLDERS



OD Grooving

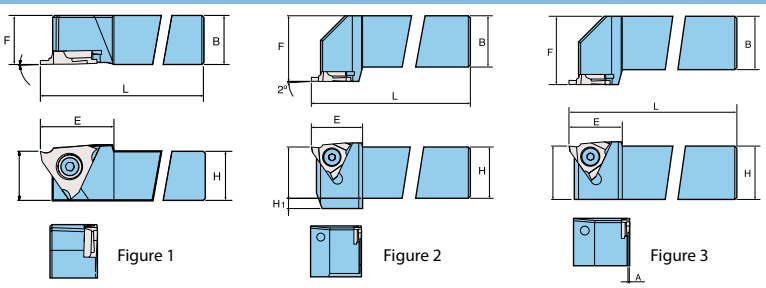

Designation	H	B	L	E	F	A	Figure.
inch							
TGTEL9.5-3C-SH	0.375	0.375	5.00	0.708	0.375	-	1
TGTEL12.7-3D-SH	0.500	0.500	6.00	0.708	0.500	-	1
TGTEL15.9-3D-SH	0.625	0.625	6.00	0.708	0.625	-	1
TGTER9.5-3C-SH	0.375	0.375	5.00	0.708	0.375	-	1
TGTER12.7-3D-SH	0.500	0.500	6.00	0.708	0.500	-	1
TGTER15.9-3D-SH	0.625	0.625	6.00	0.708	0.625	-	1
metric							
TGTER1010K16-SH	10	10	125	18	10	-	1
TGTER1212M16-SH	12	12	150	18	12	-	1
TGTER1616M16-SH	16	16	150	18	16	-	1
TGTER1616H16	16	16	150	18	20	-	2
TGTER2020K16	20	20	125	18	25	-	2
TGTER2525M16	25	25	150	18	32	-	2
TGTER2020K22-23	20	20	125	25	25	1	3
TGTER2020K22-33	20	20	125	25	25	2	3
TGTER2525M22-23	25	25	150	25	32	1	3
TGTER2525M22-33	25	25	150	25	32	2	3

Use inserts TTG, page 1339.

HARDWARE



Accepts Insert Series



Insert Screw



Torx Driver

inch			
TGTEL9.5-3C-SH	TTG 32L...	TS40E113/HG	DS-T15S
TGTEL12.7-3D-SH	TTG 32L...	TS40E113/HG	DS-T15S
TGTEL15.9-3D-SH	TTG 32L...	TS40E113/HG	DS-T15S
TGTER9.5-3C-SH	TTG 32R...	TS40E113/HG	DS-T15S
TGTER12.7-3D-SH	TTG 32R...	TS40E113/HG	DS-T15S
TGTER15.9-3D-SH	TTG 32R...	TS40E113/HG	DS-T15S
metric			
TGTER1010K16-SH	TTG 32R...	TS40E113/HG	DS-T15S
TGTER1212M16-SH	TTG 32R...	TS40E113I/HG	DS-T15T
TGTER1616M16-SH	TTG 32R...	TS40E113/HG	DS-T15S
TGTER1616H16	TTG 32R...	TS40E113I/HG	DS-T15S
TGTER2020K16	TTG 32R...	TS40E113I/HG	DS-T15S
TGTER2525M16	TTG 32R...	TS40E113I/HG	DS-T15S
TGTER2020K22-23	TTG 43R (.050"~.070")	FHM5X0.8X13-84A	L-W3
TGTER2020K22-33	TTG 43R (.080"~.100)	FHM5X0.8X13-84A	L-W3
TGTER2525M22-23	TTG 43R (.050"~.070")	FHM5X0.8X13-84A	L-W3
TGTER2525M22-33	TTG 43R (.080"~.100)	FHM5X0.8X13-84A	L-W3

INTERNAL SHALLOW GROOVING HOLDERS





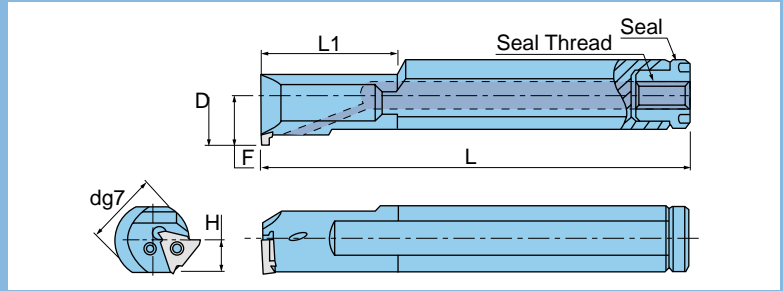

ID Grooving



Designation	d (inch)	L (inch)	L1 (inch)	F (inch)	H (inch)	Dmin (inch)	Seal	Seal Thread
TGTIL31.7-4-33	1.250	10.000	2.360	0.830	0.550	1.300	RL 125	NPT1/8
TGTIR31.7-4-33	1.250	10.000	2.360	0.830	0.550	1.300	RL 125	NPT1/8

Use insert TTG, page 1338.

HARDWARE					
	Lever	Lever Screw	Seal	Snap Ring	Allen Wrench
	LCL4B	LCS4B-T	PL32	LSR4B	L-W3

Indersoll



Ingersoll



CUTTING TOOLS
CUTTING TOOLS

TECHNICAL INFORMATION.

Cutting Tools

GENERAL TECHNICAL INFORMATION

T-CLAMP ULTRA+™

T-CLAMP ULTRA PLUS SYSTEM

This guide presents basic information that will enable you to obtain full benefit from T-CLAMP ULTRA PLUS system.

T-CLAMP ULTRA PLUS enables multi-functional operations in one system:

- Deep Grooving
- Parting and Grooving
- Shallow Grooving
- Turning and Grooving
- Precision Grooving and Recessing
- Face Grooving and Face Turning
- Undercutting and Recessing



Parting

INSERTS

- Accuracy with good repeatability
- Molded chipbreaker
- Top and bottom prism hold the insert firmly and accurately in the correct position
- TDJ/C is a unique double-ended insert for deep grooving and parting
- TSJ/C is a unique single-ended insert for deep grooving and parting
- TDT double-ended insert for side turning and grooving
- TDA double-ended insert for aluminum wheel machining

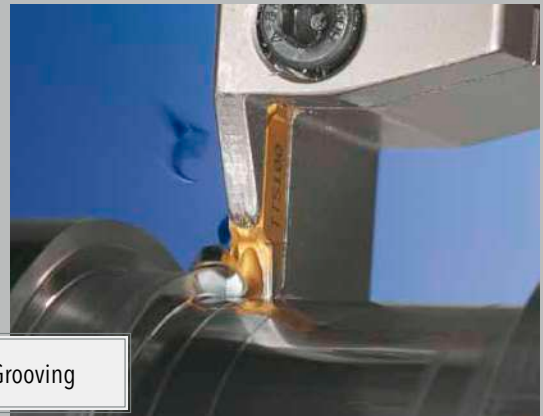

Turning & Grooving

BLADES

- Simple, accurate and rapid indexing
- Top and bottom seated insert alignment
- No additional spare parts
- Uses standard tool blocks

INTEGRAL SHANK TOOL

- Simple, accurate and rapid indexing
- Top and bottom seated insert alignment
- Stable support against side forces
- No additional spare parts
- Standard shank dimensions



Face Turning & Grooving

GENERAL TECHNICAL INFORMATION



ADVANTAGES OF T-CLAMP ULTRA PLUS SYSTEM

- T-CLAMP ULTRA PLUS is available as either double-ended or single ended insert for maximum economy
- Multifunction use. Right-hand and left-hand turning, grooving and parting with a single tool
- T-CLAMP ULTRA PLUS replaces multitude of ISO tools.
Short cycle time. Short set-up with less downtime. Reduces need for turret indexing
- Less machining time. The excellent surface finish obtained from rough turning may eliminate finish turning

T-CLAMP ULTRA PLUS SYSTEM VS. ISO-STANDARD

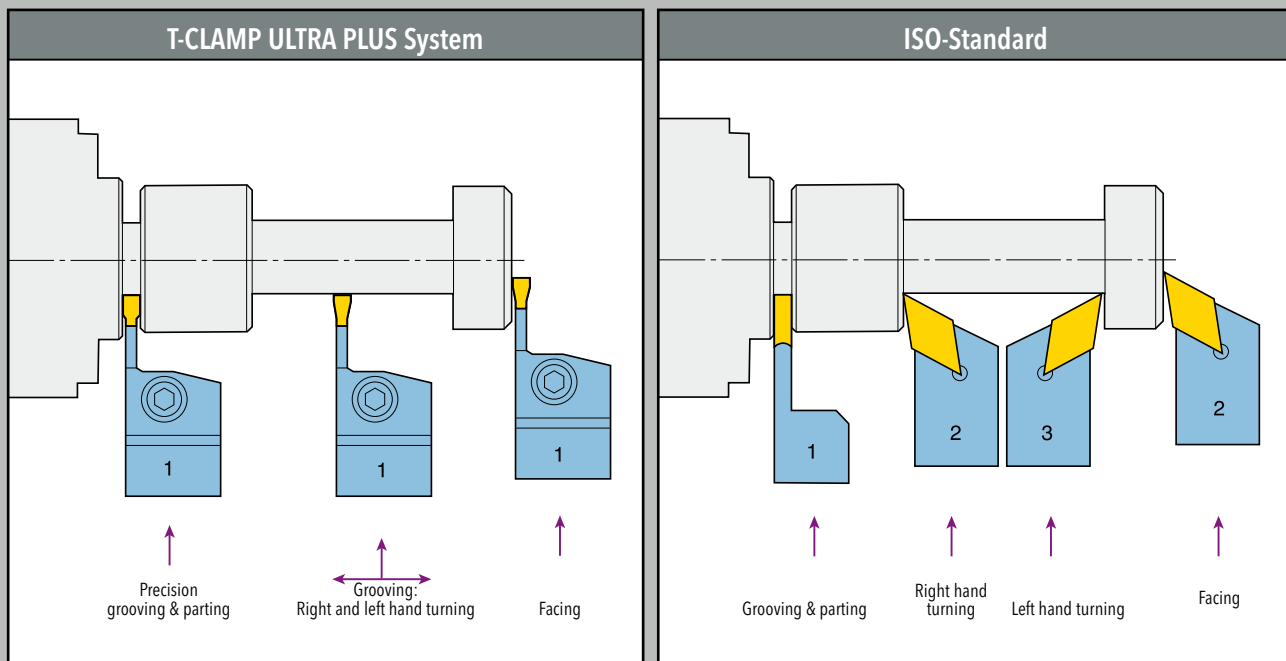

TOOL HOLDER SCREW CLAMPING FORCE

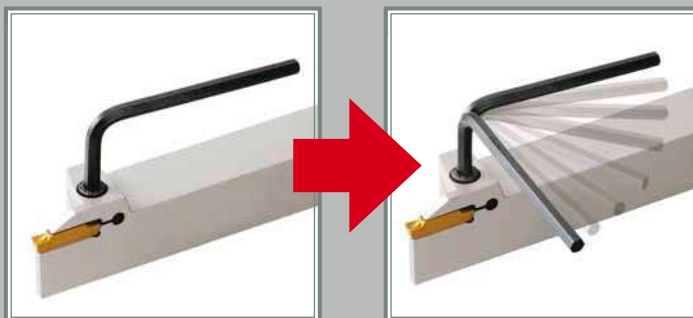

Screw	Newton Meters	in-lbs
SR34-535	2	17.7
SH M4x0.7	3.73	33.0
SH M5x0.8	5.5	48.7
SH M6x1.0	8	70.8
SH M8x1.25	12	106.2
TS60190I	4.12	36.5
TS 40E113I/HG	3.92	34.7
FH M5X0.8X13-84A	3.92	34.7

GENERAL TECHNICAL INFORMATION

TOCLAMP^{ULTRA+} PARTING AND GROOVING

SELECTING INSERTS

To match the correct insert and cutting condition, the following variables must be considered.

- Width of cut (width of insert)
- Chipbreaker style
- Lead angle
- Corner radii
- Carbide grade

Width of Cut (WOC) and Depth of Cut (DOC)

- To select the proper width and depth of cut the application must be considered. The ratio $DOC = 8 \times WOC$ can be used when cutting steel. For example, the maximum DOC for a 3mm wide insert is 0.945" for parting a 1.190" diameter bar.
- Neutral inserts with a 0° lead angle provide the maximum rigidity.

Lead Angle

- Use inserts with a lead angle to minimize pips or burrs.
- Inserts are available with either R or L hand design.
- Increasing the lead angle reduces the pips or burrs, but will also produce a poor surface finish and short tool life. Neutral inserts are recommended when a pip/burr is acceptable.

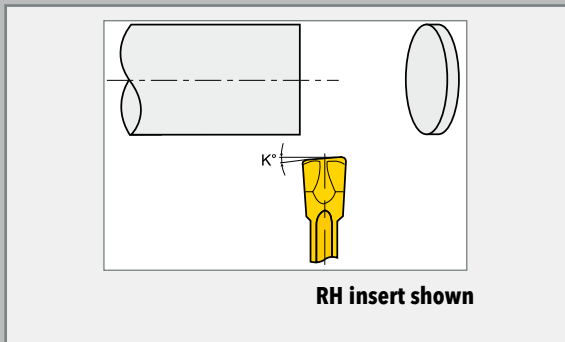

INSERT SUPPORT

- Integral shank tool holders offer the best rigidity. A self clamp holder is only recommended for radial machining.
- A screw clamp holder is recommended for axial and radial machining.

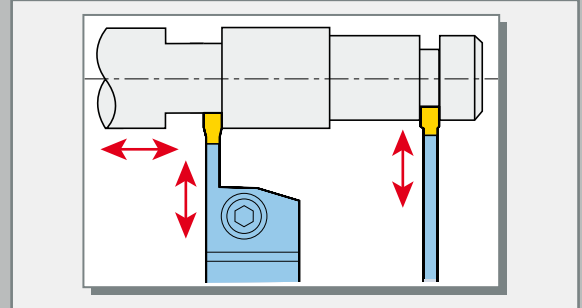

BLADE OR HOLDER SIZE:

To minimize vibration and deflection choose:

- Blade or tool holder with the smallest possible overhang (T_{max}).
- Tool holder with the maximum shank size (H).
- Blade height that is larger than T_{max} .
- Blade or tool holder with the maximum blade width (largest possible insert seat size).

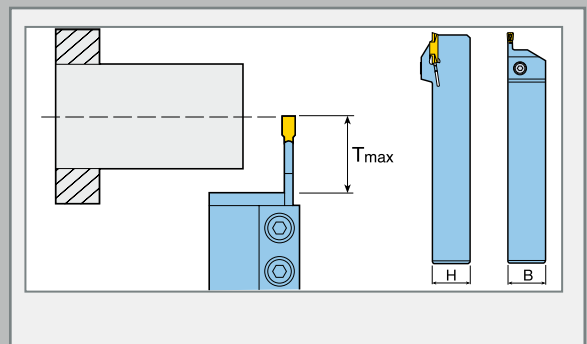

GENERAL TECHNICAL INFORMATION

TOCLAMP^{ULTRA+} PARTING AND GROOVING

90° MOUNTING

- The insert must be mounted 90° to the workpiece to obtain perpendicular surfaces to minimize vibration.

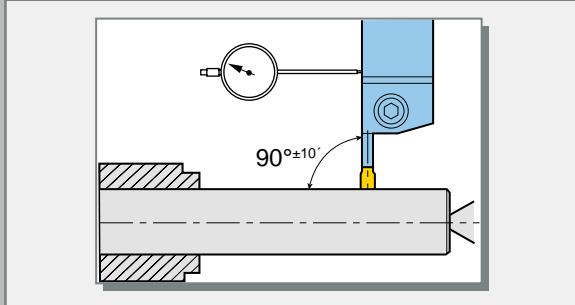

SET-UP

- The center height of the insert should be maintained within ± 0.004 ". The parting operation should be as close to the chuck as possible.

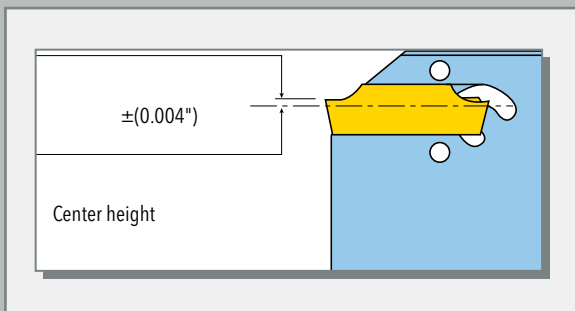

SELECTING PREFERENCE PRIORITY

- Use insert with 0° lead angle.
- Use largest blade size as possible.
- Use smallest appropriate width of cut.

MOUNTING OF INSERT

Insert clamping
Extractor for Blades (EDG-23B, EDG-33B)



MACHINING

- Consistency of speed and feed improves performance.
- Apply coolant abundantly (excluding Ceramic AB30).
- Secure insert into clean pockets.
- On a conventional lathe, lock the carriage to prevent axial motion during parting-off.

USAGE

- Replace worn inserts immediately. The price of a new insert is much less than the risk of damage from continuing with a worn edge.
- Replace blades having worn or damaged pockets.
- Never try to repair damaged pockets.

CHIPBREAKER

The function of the chipbreaker is a controlled removal of the chips from the cutting range. Therefore the width of the chips are reduced by the chipbreaker. Chips with reduced width have the following advantages:

- Eliminates friction with groove walls.
- Prevents chip overload.
- Permits higher feeds.
- Produces unscratched surfaces, eliminating additional facing.

Curling chips into compact spirals or breaking chips simplifies disposal. Curling is affected by the chipbreaker type and the machining conditions.

GENERAL TECHNICAL INFORMATION

TOCLAMP^{ULTRA+} PARTING AND GROOVING

SELECTION OF CHIPBREAKERS

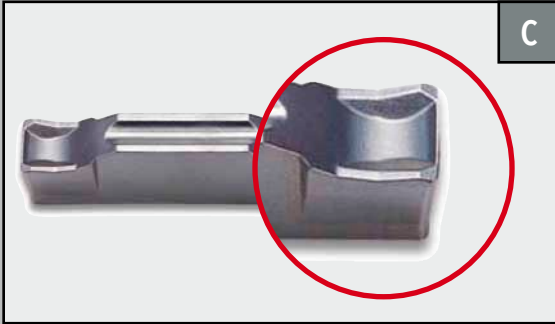

- First choice for hard materials and tough applications
- For general applications on steel, alloy steel and stainless steel
- Medium to high feeds

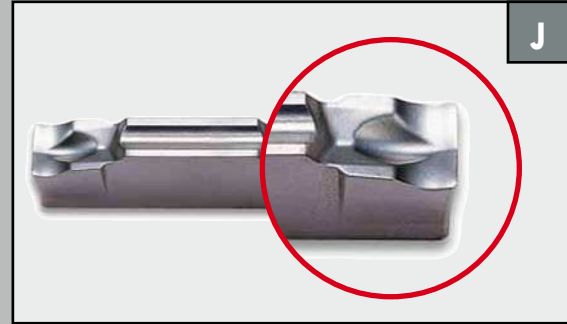

- First choice for soft materials, parting of tubes, small diameters and thin-walled parts.
- Low forces and smaller burrs
- Improved straightness
- Low to medium feeds

Recommended feed range as a function of insert width Material SAE4140 (HB240)

Recommendations are for neutral inserts - for R/L inserts reduce feeds by 20 - 40%

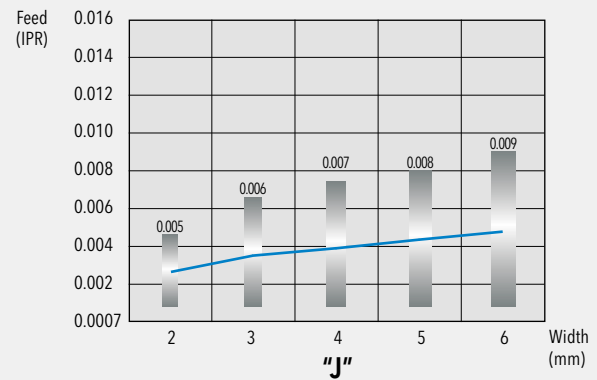
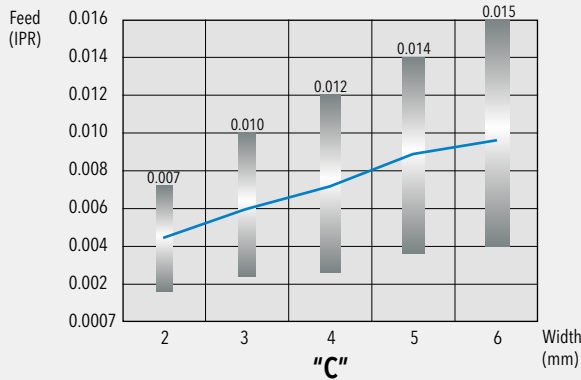

Workpiece Materials					
	Alloy steel	Austenitic stainless steel	High-temp alloys	Non-ferrous materials	Cast iron
High ↑ Feed ↓ Low	C	C	C	C Brass	C
	J	J	J Titanium	J Aluminum	

GENERAL TECHNICAL INFORMATION

TOCLAMP^{ULTRA+} PARTING AND GROOVING

PRACTICAL TROUBLE SHOOTING

1. TO REDUCE BURR

- On CNC reduce feed by 75% when approaching center stub diameters \approx WOC
- Check center height of cutting edge
- Use insert with lead angle
- If 0° lead angle must be used for whatever reason, apply narrow WOC
- Apply a supporting part-catcher (or adjust concentricity)
- For hollow bars, it is better to machine chamfers using ID boring tool prior to parting operation. (See picture)

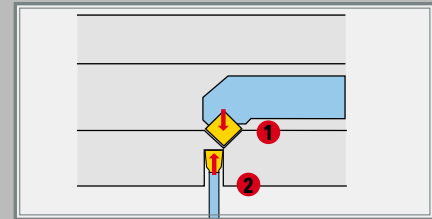
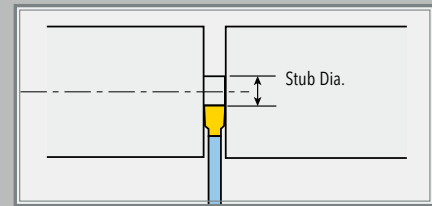

2. TO IMPROVE SURFACE FINISH

- Increase cutting speed
- Use neutral inserts
- Select chipformer that provides optimum chip control
- Use coated carbide
- Improve coolant application
- Eliminate chatter

3. TO IMPROVE FLATNESS

- Check inserts and replace any that show wear.
- Use neutral inserts
- Use largest blade possible, i.e. TGB 32- instead of TGB 26-
- Increase blade thickness and insert width
- Minimize blade overhang
- Check alignment and perpendicularity of tool to machine axis
- Optimize workpiece chucking
- Lock the carriage on manually operated lathes
- Apply coolant abundantly (excluding Ceramic AB30)
- Reduce feed

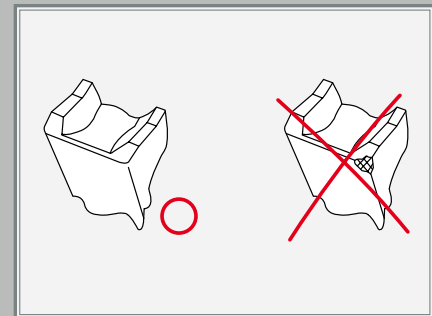

4. TO IMPROVE CHIP CONTROL

- Replace worn inserts
- Choose a more appropriate chipbreaker
- Use a neutral insert
- Check alignment and perpendicularity of tool to machine axis
- Apply coolant abundantly
- Increase feed
- At initial groove depth, interrupt feed momentarily to let the chip enter slot

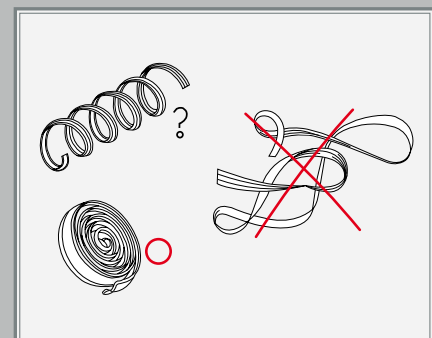

GENERAL TECHNICAL INFORMATION

TOCLAMP^{ULTRA+} PARTING AND GROOVING

PRACTICAL TROUBLE SHOOTING

5. TO ELIMINATE CHATTER

- Part-off as close to chuck as possible
- Minimize blade overhang
- Improve chucking and monitor tool setup
- Change the RPM
- Increase the feed
- Lock the carriage on manually operated lathes

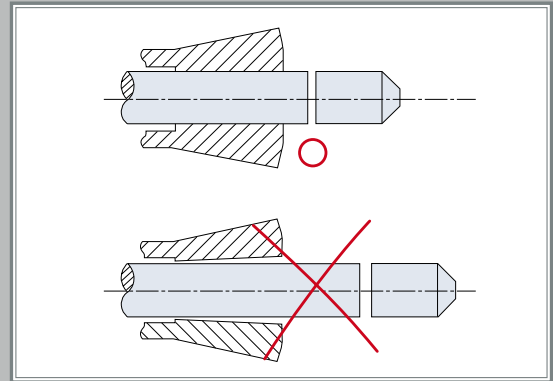

6. TO PREVENT CHIPPING OF CUTTING EDGE

- Use appropriate carbide grade and geometry
- Use insert with larger corner radii
- Reduce feed at end of cut
- Eliminate chatter
- Increase speed
- Use tougher grade
- Increase tool and set-up rigidity
- Eliminate build-up edge

7. TO PREVENT OR REDUCE BUILT-UP EDGE

- Use appropriate carbide grade and geometry
- Increase speed
- Reduce feed
- Increase coolant flow / concentration. Recommended is coolant on oil base.

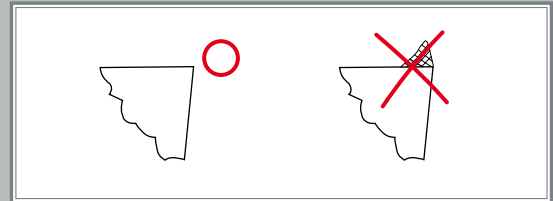

8. PARTING ON ECCENTRIC TUBES

- Inserts with 4 degree lead angle are usually recommended for tubes. However, the combination of an eccentric bore and machine resiliency may increase feed snap on breakthrough and damage the cutting edge. Changing to a 8 degree lead angle insert will moderate the breakthrough.

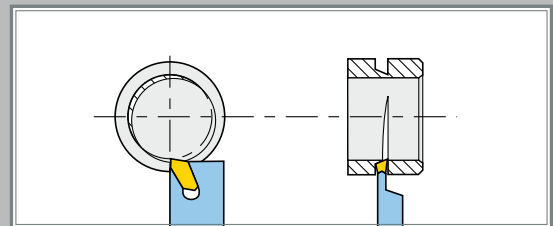

GENERAL TECHNICAL INFORMATION

Recommended Cutting Speed with ISO K Grades - T-Clamp Ultra Plus

Cast Iron and Nonferrous Materials

Materials		Hardness Brinell HB	Grade K10
			Cutting Speed (sfm)
Carbon Steel	Low tensile, grey	180	200-265
	High tensile, grey, alloy	250	165-230
Malleable Iron	Short-Chipping	110-145	230-330
	Long-Chipping	200-250	230-295
Nodular Iron	Ferritic	160	200-280
	Pearlitic	250	150-250
	Chilled Cast Iron	400	50-80
Bronze	Lead Alloy	110	490-720
	Brass, Red brass	100	390-590
	Phosphor-bronze	100	330-460
Magnesium		40-90 HRB	820-885
Aluminum		40-90 HRB	820-1475

Nickel - base Alloys

Materials	Hardness Brinell HB	Grade K10
		Cutting Speed (sfm)
Astroloy, Rene41	Sol 240-300	65-100
Udimet 500, 700	S & A 310-400	50-80
Inconel W, X, 702, 718	Sol 240-300	50-100
M252, Waspaloy	S & A 400-410	50-80
Hastelloy	Annealed	80-130
	90-100 HRB	
Inconel 600	Cold drawn	65-115
	250-330	
TD2	Stress relieved 300	165-210

Titanium - base Alloys

Materials	Hardness Brinell HB	Grade K10
		Cutting Speed (sfm)
Ti5Al - 2.5Sn	Annealed 310-370	130-165
Ti6Al - 4V	Annealed 310-370	130-165
	S & A 370-410	80-130
Ti6Al - 6V - 2Sn	Annealed 380-420	100-135
Ti7Al - 4MO	S & A 380-420	100-130
Ti8AlMO - 1V		
TiA55	Annealed 110-175	460-525
Ti75A	Annealed 300-350	130-165
Ti140A		

Cobalt - base Alloys

Materials	Hardness Brinell HB	Grade K10
		Cutting Speed (sfm)
HS21, HS31, HS36	As Cast 90-98 HRB	65-80
L605	Sol 90-98 HRB	65-80
	S & A 280-330	50-65
Stellite 6	370-420	50-65

S & A-Solution and aging
Sol-Solution treatment

GENERAL TECHNICAL INFORMATION

TOCLAMP^{ULTRA+} TURNING AND GROOVING

CHIPBREAKER STYLE: "T"

- The "T" chipbreaker is available for turning and grooving of steel, alloy steel and stainless steel
- Inserts with "T" style chipbreaker contain a central chipbreaking island for multi-direction chip control

"T" Type

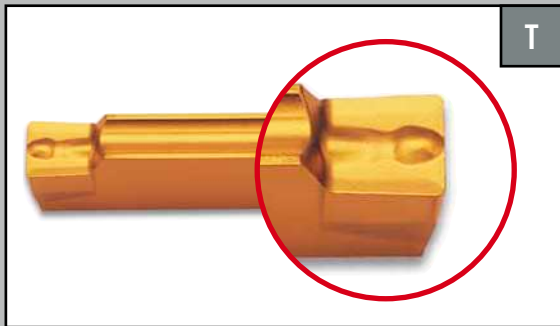

- Machining range of turning depends on width of inserts.

Workpiece: SAE 1045 (C45)

Cutting Speed: $V_c=328 - 590$ in/min

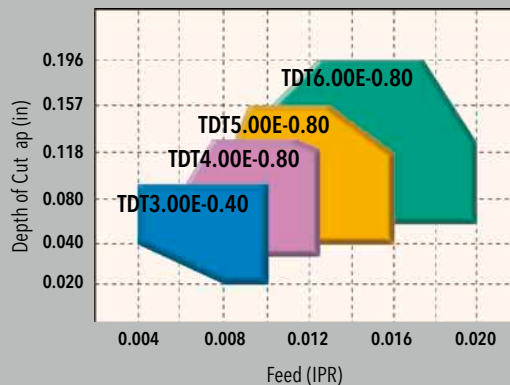

Reduce cutting speed 20 - 30% for internal & face machining

TOOL HOLDER OR BLADE SIZE

To minimize risk of vibration and deflection always choose:

- Tool holder or blade with the smallest possible overhang.
- Tool holder with maximum shank dimension.

90° MOUNTING

It's very important that the insert is mounted at 90° to the center line of the workpiece in order to obtain a perpendicular surface and reduce the risk of vibration.

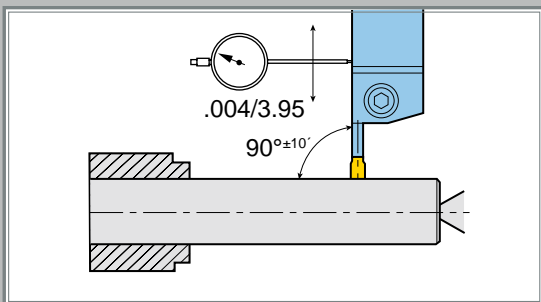

MACHINING DEFINITIONS

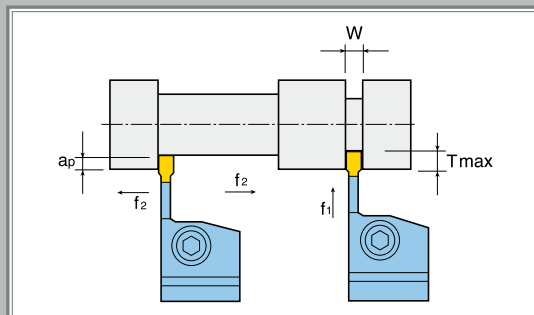

Grooving

- V_c - Cutting speed (SFM)
- T - Maximum depth (in)
- f_1 - Feed in radial direction (in/rev)

Turning

- V_c - cutting speed (SFM)
- a_{pmax} - maximum depth of cut (in)
- f_2 - feed in lateral direction (in/rev)

GENERAL TECHNICAL INFORMATION

TOCLAMP^{ULTRA+} TURNING AND GROOVING

SELECTING INSERTS

INSERT WIDTH

- Insert width strongly affects strength
- For most efficient machining select the widest possible insert
- Chipbreaking range depends on insert width
- A narrow width improves chipbreaking at lower feed rates
- Wide inserts and strong blades require high forces and feed rates to achieve a frontal clearance angle.

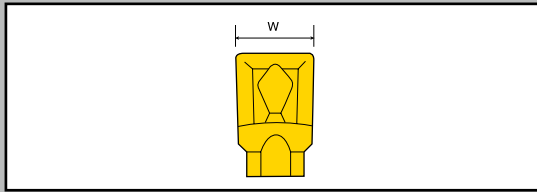

TURNING FEED

- Feed depends on chipbreaking range of the insert
- Maximum feed depends on insert width and is a function of maximum load
- High feed with small corner radii may reduce tool life
- Maximum feed should not exceed the corner radii
- For better chip formation when grooving, feed can be interrupted at small intervals

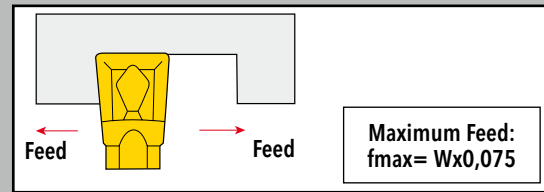

CORNER RADII - LATERAL TURNING

- Choose large corner radii for long tool life
- Choose small corner radii to reduce cutting load and lower feed with narrow inserts

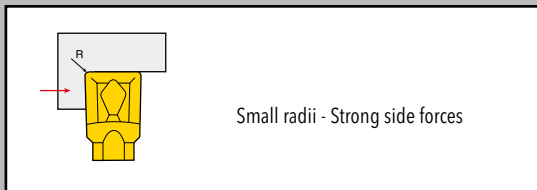
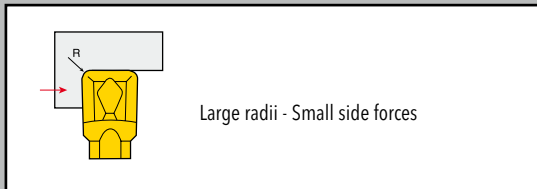

DEPTH OF CUT

- Minimum depth of cut equals the corner radii
- Maximum depth of cut depends on maximum possible load
- Depth of cut depends on chipbreaking range

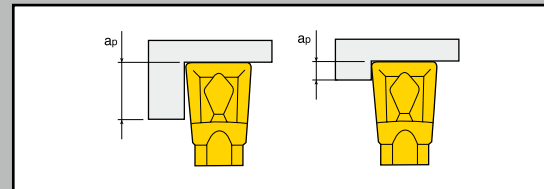

Large depth of cut causes large deflection and large frontal clearance..

With small depth of cut, deflection and frontal clearance may be too small.

Maximum depth of cut : $ap_{max} = W \times 0,8$

GENERAL TECHNICAL INFORMATION

TOCLAMP^{ULTRA+} TURNING AND GROOVING

PRINCIPLE OF TURNING WITH T-CLAMP ULTRA PLUS TOOLS

- The clearance angle α° is a function of the side cutting forces and is not constant as is the case with ISO inserts.

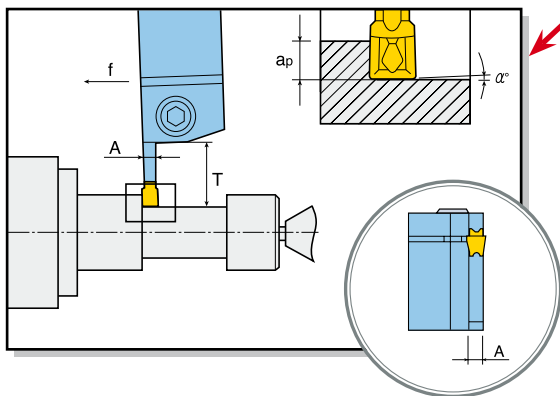

Clearance angle between the insert and workpiece

The deflection is influenced by:

- Feed: f
- Depth of cut: a_p
- Overhang: T
- Cutting speed: V_c
- Workpiece Material

✳ When these factors are properly applied, the insert (α°) creates a "Wiper" action providing excellent surface quality and tolerance.

FINISHING OPERATION: DIAMETER COMPENSATION

- A compensation factor for the finish diameter must be used in the final machining operation. After grooving to the desired diameter, the machining direction changes to longitudinal turning. At this point deflection occurs. If machining continues without tool compensation, corner A will penetrate the workpiece as a result of the deflection phenomenon. (See picture) This will result in two different diameters $\varnothing D_1$ from the grooving operation and $\varnothing D_2$ from the turning operation. The difference between $\varnothing D_1$ and $\varnothing D_2$ is the change in diameter, designated at Delta Δ . Tool compensation factor is calculated as shown:

$$\frac{\Delta}{2} = \frac{\varnothing D_1 - \varnothing D_2}{2}$$

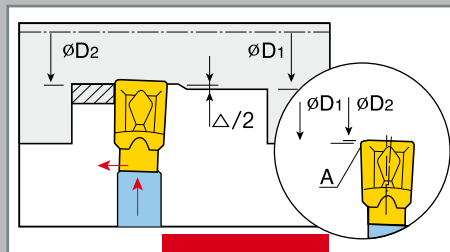

Not recommended

- Using the compensation factor will eliminate the difference in part diameter. Follow this simple procedure during machining.

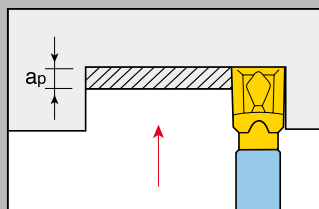

1. Groove to the final diameter.

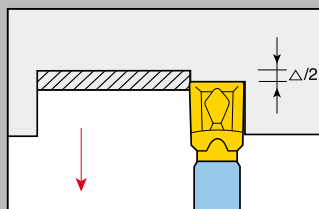

2. Pull the tool back, with a value of $\Delta/2$.

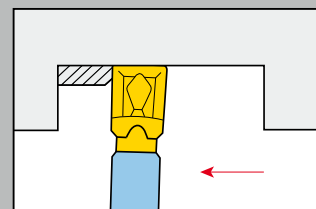

3. Continue the finish turning operation.

Recommended

GENERAL TECHNICAL INFORMATION

TOCLAMP^{ULTRA+} TURNING AND GROOVING

MULTIFUNCTION OPERATIONS

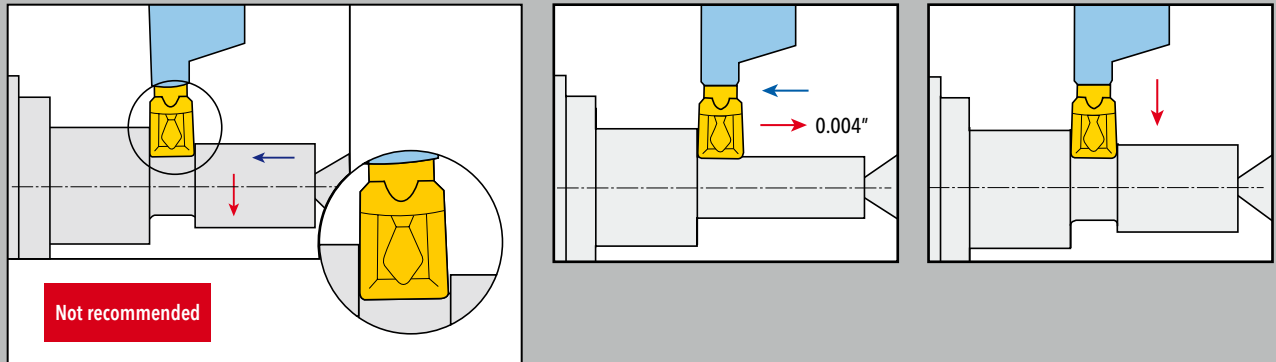

The tools are multifunctional tools able to operate in a sequence of grooving and turning modes. Moving from turning to grooving requires consideration of the basic principle to eliminate the possibility of insert breakage. In this situation one must release the side deflection necessary in turning but not recommended in grooving.

MACHINING A RADIUS OR CHAMFER

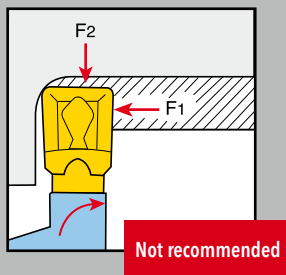

The machining of a corner with a radius or a chamfer larger than the radius of the insert always requires the combination of movement in two directions. Problems, such as insert breakage, result when this combined operation is used while the insert is plunged into the workpiece with material on all sides. Insert breakage is caused by forces acting simultaneously in two different directions F1 and F2 as shown.

Recommended procedure to optimize machining and eliminate insert breakage

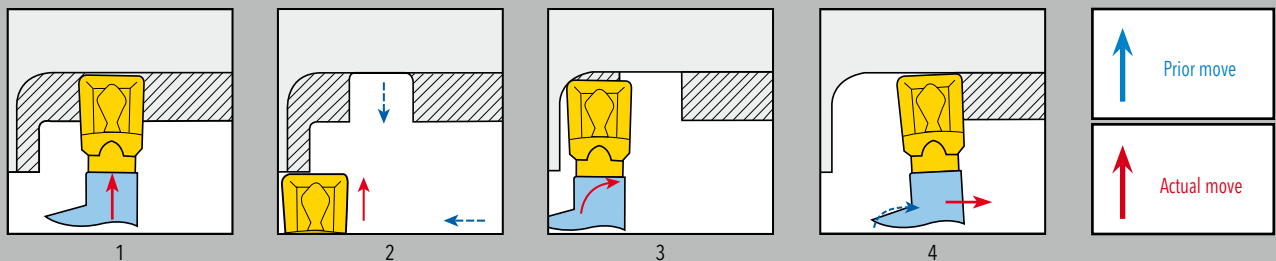

GENERAL TECHNICAL INFORMATION

T-CLAMP^{ULTRA+} TURNING AND GROOVING

MACHINING BETWEEN WALLS

One of the most important advantages of T-CLAMP ULTRA PLUS system is the ability to machine between walls.

To achieve the best result - follow recommended sequence:

Leave steps near a wall. Don't arrive with the same Z-value!!!

Roughing 1

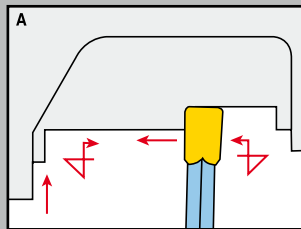

Z-value / Valeur-Z = .008" - .012"

Roughing 2

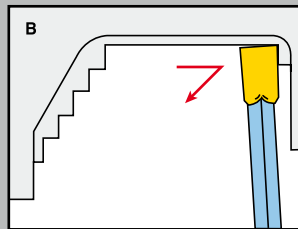

Finishing 3

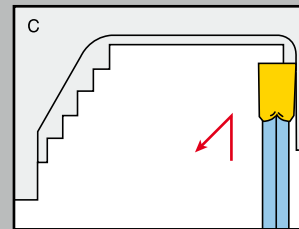

Finishing 4

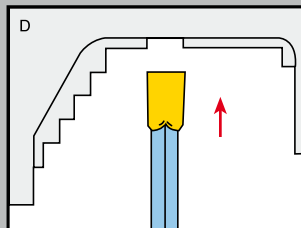

Finishing 5

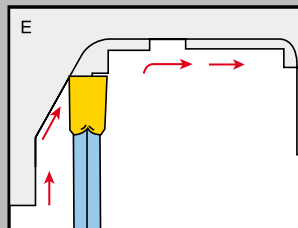

Finishing 6

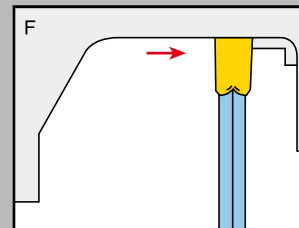

ELIMINATING A "HANGING RING"

When turning at the end of a bar or toward a recess between two walls, a 'Hanging Ring' may be formed. To eliminate the 'Hanging Ring':

Roughing (incorrect)

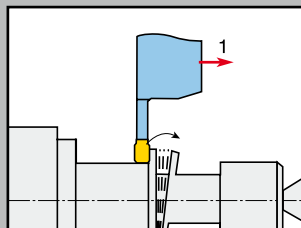

Roughing (correct)

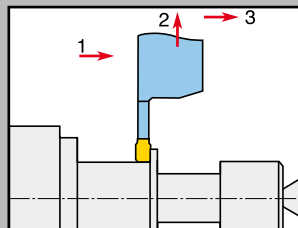

Finishing (correct)

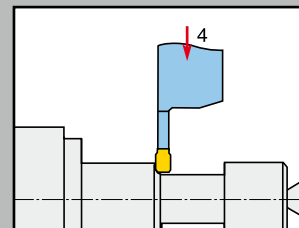

GENERAL TECHNICAL INFORMATION

TOCLAMP^{ULTRA+} TURNING AND GROOVING

OPTIMIZING INTERNAL MACHINING

Tool holder overhang

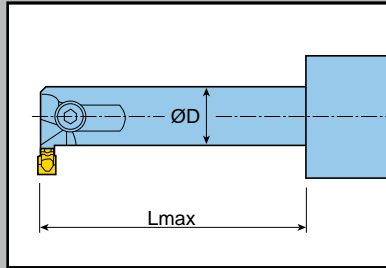

$$L_{\max} \leq 3D$$

Efficient use of insert corners

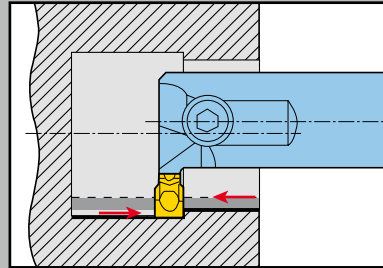

1. The first pass uses one corner for roughing.
2. The other corner is used on the return path for semi-finishing or finishing.
3. Tool position looks out of sequence with the amount of material that is removed.
4. Rapid position back to initial groove, continue with face turning toward center.

IMPROVING INTERNAL TURNING IN A BLIND HOLE

Internal turning in a blind hole brings about the problem of chip evacuation. When the tool reaches the rear side wall, chips may be caught between the wall and the insert, causing breakage.

Two solutions that can eliminate this problem:

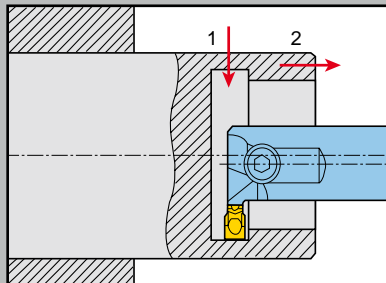

First solution

1. Start by grooving at the rear wall.
2. Continue by turning from the inside toward the outside.

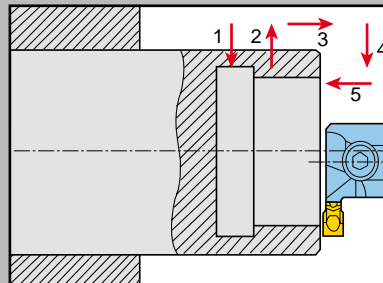

Second solution

1. Start by grooving at the rear wall.
2. Pull the tool back to the outside. Turn the final diameter from outside toward the groove.

GENERAL TECHNICAL INFORMATION

TOCLAMP^{ULTRA+} TURNING AND GROOVING

SURFACE QUALITY

ELIMINATING GRINDING OPERATIONS

Turning with T-CLAMP ULTRA PLUS tools gives a surface quality superior to anything possible when using standard ISO tools. In fact, turning with T-CLAMP tools can produce a surface quality comparable to grinding.

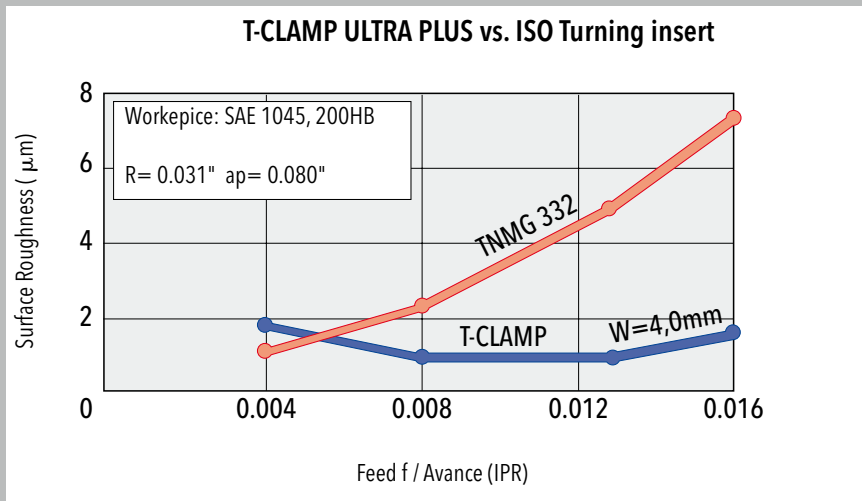

CALCULATION OF REQUIRED MACHINE POWER

Turning

$$P = \frac{K_c \cdot a_p \cdot f \cdot V_c}{\eta \cdot 45 \cdot 10^3} \text{ [HP]}$$

Turning

$$P = \frac{K_c \cdot a_p \cdot f \cdot V_c}{\eta \cdot 61 \cdot 10^3} \text{ [kw]}$$

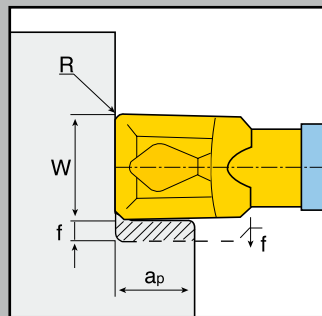

Grooving parting

$$P = \frac{K_c \cdot W \cdot f \cdot V_c}{\eta \cdot 45 \cdot 10^3} \text{ [HP]}$$

Grooving parting

$$P = \frac{K_c \cdot W \cdot f \cdot V_c}{\eta \cdot 61 \cdot 10^3} \text{ [kw]}$$

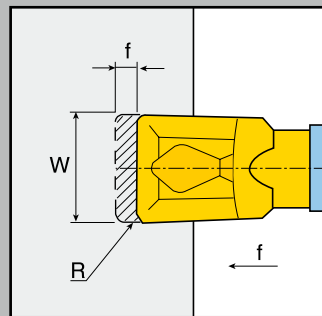

Face grooving

$$P = \frac{K_c \cdot W \cdot f \cdot V_c}{\eta \cdot 45 \cdot 10^3} \text{ [HP]}$$

Face grooving

$$P = \frac{K_c \cdot W \cdot f \cdot V_c}{\eta \cdot 61 \cdot 10^3} \text{ [kw]}$$

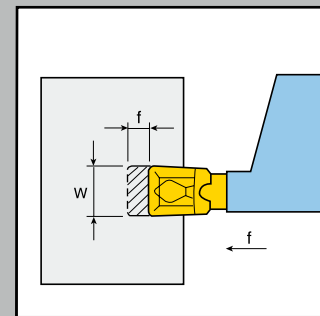

Where K_c appears - specific cutting forces (N/mm^2) could be used.
 - η Efficiency ($\eta \approx 0,8$)

GENERAL TECHNICAL INFORMATION

USER GUIDE - TURNING & GROOVING

Recommended Cutting Conditions with TDXU

Materials		Hardness Brinell HB	External Turning			External Grooving			Internal Turning			Internal Grooving			Face Turning			Face Grooving		
			Feed (ipr)																	
TDXU 3E-0.3 TT5100			.004	.006	.008	.004	.006	.008	.004	.006	.008	.004	.006	.008	.004	.006	.008	.004	.006	.008
TDXU 4E-0.4 TT5100			.004	.008	.010	.004	.008	.010	.004	.008	.010	.004	.008	.010	.004	.008	.010	.004	.008	.010
TDXU 5E-0.4 TT5100			.004	.008	.012	.004	.008	.012	.004	.008	.012	.004	.008	.012	.004	.008	.012	.004	.008	.012
			Cutting Speed (sfm)																	
Carbon	0.2%C	150	689	574	361	492	410	262	541	459	279	377	328	197	558	459	295	492	410	262
Steel	0.45%C	190	656	525	328	459	361	230	509	410	262	361	295	180	525	427	262	459	361	230
	0.83%C	250	623	492	295	443	344	213	492	394	230	344	279	164	492	394	230	443	344	197
Alloy Steel	≤ 200		623	492	295	443	344	213	492	394	230	344	279	164	492	394	230	443	344	197
	200-250		607	476	279	427	335	197	476	377	213	328	262	164	492	377	230	427	344	197
	275-325		591	459	262	413	328	184	459	361	197	328	262	148	476	361	213	410	328	180
	325-375		410	246	164	295	180	115	328	197	131	230	131	98	328	197	131	295	180	131
	375-425		279	197	131	197	131	98	230	164	98	164	115	66	230	164	98	197	131	98
Stainless Steel	Mart	175-225	558	476	312	394	328	230	443	377	246	312	262	164	459	394	262	394	328	230
		275-325	427	377	279	295	262	197	328	295	213	230	213	164	344	295	230	295	262	197
	Aust	135-175	492	410	328	344	289	230	394	328	262	279	230	180	394	328	262	344	295	230

Chip Control Range

Grooving Applications

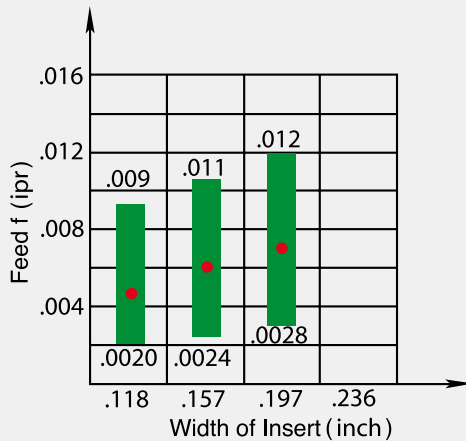

Turning Applications

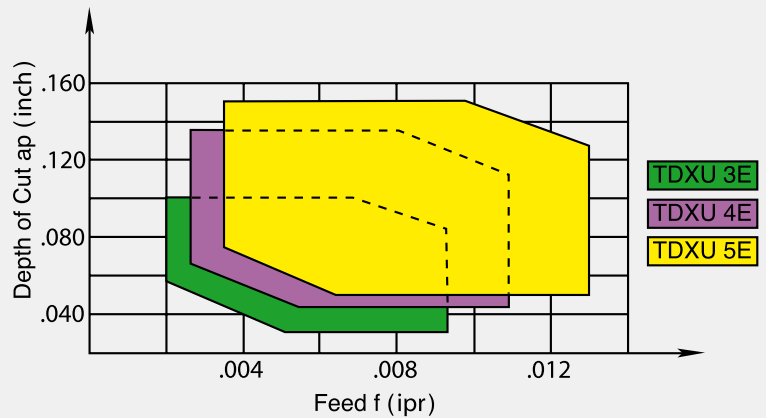

GENERAL TECHNICAL INFORMATION

Recommended Machining Conditions

Turning with **TDT-E**
Type Inserts

TT5100 (**P20** - **P40**) and TT7220 (**P25** - **P45**) Coated Carbide Grade
P Steel

Insert		3.00E-0.4			4.00E-0.8			5.00E-0.8			6.00E-0.8			6.00E-1.20			
		Feed (ipr)															
Materials	Hardness Brinell HB	.004	.006	.010	.006	.010	.016	.010	.016	.020	.010	.016	.022	.012	.018	.022	
		Cutting Speed (sfm)															
Carbon Steel	0.2%C	150	640	591	459	689	574	361	607	443	344	640	443	344	656	492	410
	0.45%C	190	591	541	427	656	525	328	558	394	262	591	394	262	591	410	328
	0.83%C	250	558	509	410	623	492	295	541	344	246	558	344	246	492	361	279
Alloy Steel	≤ 200	558	509	410	623	492	295	541	328	246	558	328	246	558	361	279	
	200-250	525	476	394	607	476	279	525	312	230	541	312	230	541	344	262	
	275-325	492	443	377	591	459	262	492	295	197	525	295	197	525	328	230	
	325-375	377	295	164	410	246	164	361	213	164	377	230	164	361	262	197	
	375-425	230	197	98	279	197	131	197	164	115	262	197	131	279	213	164	
Stainless Steel	Mart	175-225	541	476	394	558	476	312	591	443	295	607	427	262	541	459	295
		275-325	410	377	295	427	377	279	492	361	279	525	361	230	492	377	279
	Aust	135-175	443	394	328	492	410	328	525	377	279	525	377	246	541	394	279
Cast Steel	Carbon	≤ 150	427	377	328	443	377	262	410	295	246	427	312	230	443	344	262
		150-200	344	295	246	361	295	246	328	279	213	361	295	213	394	312	246
	Alloyed	200-250	312	279	197	328	246	213	279	230	197	295	262	197	344	262	230

Turning with **TDT-E** Type Inserts

K10 Uncoated Carbide Grade
K Cast Iron **N** Nonferrous Materials

Insert		TDT-E	K10		
			Feed (ipr)		
Materials	Hardness Brinell HB	.004	.006	.008	
		Cutting Speed (sfm)			
Malleable Iron	Short-chipping	110 - 145	459	361	295
	Long-chipping	200 - 250	443	344	262
Cast Iron	Low tensile, gray	180	525	344	262
	High tensile, gray, alloy	250	394	295	213
Nodular Iron	Ferritic	160	427	328	230
	Pearlitic	250	410	295	213
Chilled Cast Iron		400	66	49	-
		600	49	33	-
Bronze-Brass-Alloys:		120 - 200	427	344	230
Lead Alloy		80 - 150	591	558	541
Brass, Red Brass		60 - 110	459	443	410
Phosphor-Bronze		85 - 110	328	312	295
Aluminum Alloys:		150 - 200	787	722	656
Non-heat Treatable		30 - 80	2822	2723	2625
Heat Treatable		80 - 120	1083	1050	984
Aluminum Alloys, Cast			1148	1083	984
Magnesium		40 - 60HRB	1132	1050	919
		60 - 90HRB	820	787	755
Electrolytic Copper		50 - 85	427	410	394

• For Grooving, reduce cutting speed by 20 - 30%

GENERAL TECHNICAL INFORMATION

USER GUIDE TURNING & GROOVING

Recommended Machining Conditions

Turning with TDT-E Type Inserts

TT7220 (P25 - P45) & TT5100 (P20 - P40) Coated Carbide Grade, **K10** Uncoated Carbide Grade

M Stainless Steel

Materials		TT7220(P25 - P45) TT5100(P20 - P40)			K10		
		Feed (ipr)					
Commercial Designation	Hardness	.004	.006	.010	.004	.006	.008
		Cutting Speed (sfm)					
V 57, A286	Sol	-	-	-	164	115	82
	81 HRB						
Incoloy 800, 801	S & A	-	-	-	180	131	98
	24 - 34HRC						
Austenitic Stainless Steel 302, 303, 304, 310 316, 321, 347	Annealed	295	279	246	213	180	164
	135 - 175 HB						
Martensitic Stainless Steel	Annealed	443	410	328	230	213	197
	135 - 175 HB						
403, 405, 410, 420 430, etc.	Q & T	328	295	279	-	-	-
	28 - 35 HRC						
17-4 PH	Sol	443	427	410	-	-	-
	28 - 35 HRC						
17-7 PH	S & A	262	246	230	-	-	-
	36 - 40 HRC						
Maraging Steel 120, 180, 200, 250 300, 350 Grade	Annealed	427	410	394	-	-	-
	26 - 34 HRC						
120, 180 Grade	Maraged	230	213	197	-	-	-
	38 - 45 HRC						
200, 250, 300 350 Grade	Maraged	-	-	-	98	82	-
	50 - 52 HRC						

- Sol-Solution
- S&A-Solution and Aging
- Q&T-Quenched and Tempered

Recommended Machining Conditions for Ceramic TaeguTclamp Insert

Material		Grooving	Turning
Cast Iron	Vc (sfm)	1969 - 2625	1969 - 2625
	F (ipr)	.004 - .008	.004 - .009
High hardened steel	Vc (sfm)	Not recommended	820 - 1148
	F (ipr)		.003 - .008

- Above condition is adapted to TDT 4E-0.4T CE AB30.

GENERAL TECHNICAL INFORMATION

Recommended Machining Conditions

High - Temp Alloys		Turning			Grooving and Undercutting		
K10 Uncoated Carbide Grade							
S Titanium - Base Alloys							
Materials		K10					
		Feed (sfm)					
		.004	.006	.008	.002	.004	.006
Commercial Designation	Hardness	Cutting Speed (ipr)					
Ti6 - 2 - 4 - 2	Annealed 32 - 38 HRC	180	164	148	164	148	131
Ti6Al - 4V	Annealed 32 - 38 HRC	164	131	115	164	148	131
	Solution & Aging 38 - 42 HRC	131	115	98	131	98	82
Ti6Al - 6V - 2Sn	Annealed 34 - 38 HRC	148	131	115	148	131	115
Ti7Al - 4Mo	Solution & Aging 40 - 44 HRC	131	115	98	131	115	98
Ti8Al - 1Mo - 1V							
TiA55	Annealed 110 - 175 HB	525	509	492	525	492	459
Ti75A							
Ti140A	Annealed 30 - 36 HRC	164	148	131	164	148	131

Nickel - Base Alloys		Turning			Grooving and Undercutting		
Materials		K10					
		Feed (sfm)					
		.004	.006	.008	.002	.004	.006
Commercial Designation	Hardness	Cutting Speed (ipr)					
Astroloy, Rene 41	Solution 20 - 30 HRC	-	82	66	98	82	66
Udimet 500, 700	Solution & Aging 32 - 42 HRC	-	66	49	82	66	49
Inconel W, X, 702, 718	Solution 20 - 30 HRC	-	82	66	98	82	66
M 252, Waspalloy	Solution & Aging 40 - 42 HRC	-	66	49	82	66	49
Hastalloy B, C, X	Annealed 90 - 100 HRB	-	98	82	115	98	82
Inconel 600	Cold drawn 24 - 34 HRC	-	82	66	98	82	66
TD 2	Stress relieved 30 HRC	-	213	197	213	197	164

Cobalt - Base Alloys		Turning			Grooving and Undercutting		
Materials		K10					
		Feed (sfm)					
		.004	.006	.008	.002	.004	.006
Commercial Designation	Hardness	Cutting Speed (ipr)					
HS 21, HS 31, HS 36	As cast 20 - 30 HRC	-	66	49	-	66	49
L 605	Solution 90 - 98 HRB	-	82	66	-	82	66
	Solution & Aging 28 - 34 HRC	-	66	49	-	66	49
Stellite 6	39 - 43 HRB	-	49	33	-	49	49

Iron Base Alloys		TT7220(P25 - P45) TT5100(P20 - P40)			K10		
Materials		Feed (sfm)					
		.004	.006	.010	.004	.006	.008
Commercial Designation	Hardness	Cutting Speed (ipr)					
V57, A286	Solution 81 HRB	-	-	-	541	361	262
Incoloy 800, 801	Solution & Aging 24-34 HRC	-	-	-	591	427	328

GENERAL TECHNICAL INFORMATION

TOCLAMP^{ULTRA+} FACE MACHINING

TOOL SELECTION

Follow these three recommendations to select the correct cutting tool:

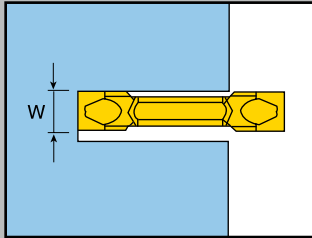

Choose the widest possible insert and tool, according to the cutting width and geometry to be machined.

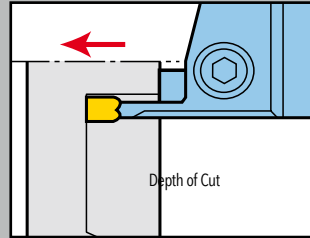

Choose the shortest tool blade overhang, according to the maximum depth required.

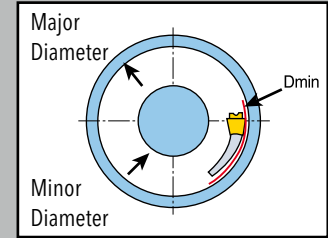

Choose the tool range with the largest diameter depending on the initial grooving diameter required in the application.

TOOL ADJUSTMENT

Prior to machining, check and adjust the following tool positions

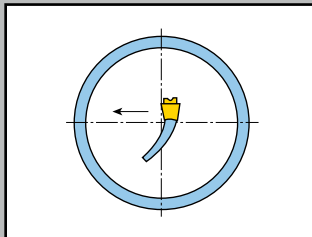

Check the cutting edge height at centerline, machine in light turning down to center, and check for burr.

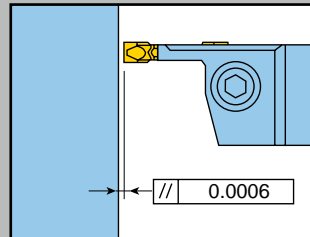

Check parallelism of cutting edge and the machined surface. Correct position can guarantee good surface quality when face turning in both directions.

GENERAL TECHNICAL INFORMATION

T-CLAMP ULTRA+ FACE MACHINING

OPTIMIZING THE MACHINING PROCEDURE

FOR ROUGHING

Basic steps for roughing operations when face turning with T-CLAMP ULTRA PLUS tools:

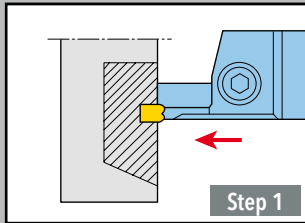

Grooving into initial diameter range

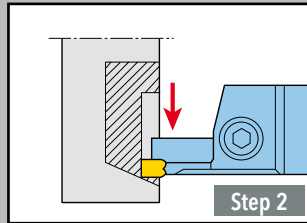

Turning away from center

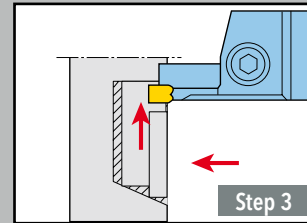

Face turning toward center

- When face grooving, reduce the speed by 40% in relation to that used in face turning.

FOR FINISHING

Basic steps for finishing operations when face turning with T-CLAMP ULTRA PLUS tools:

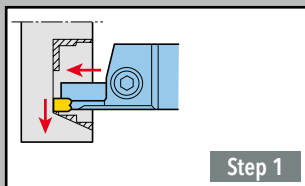

After initial groove move away from center

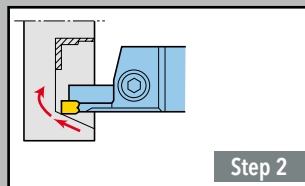

Finish major diameter and radius

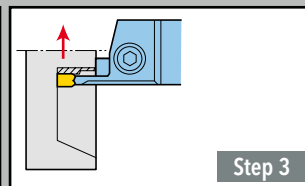

Face turning toward center

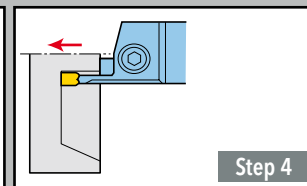

Finish minor diameter

- When face grooving, reduce the speed by 40% in relation to that used in face turning.

GENERAL TECHNICAL INFORMATION

USER GUIDE - FACE MACHINING

Recommended Machining Conditions for Face Grooving

Material		Hardness Brinell HB	Cutting Speed (sfm)		Feed (ipr)				
			K10	T17220	TDT 3	TDT 4	TDT 5	TDT 6	TDT 8
Carbon Steel	0.2%C	150		361 - 459					
	0.45%C	190		328 - 427					
	0.83%C	250		295 - 361					
Alloy Steel	< 200			262 - 427					
	200 - 250			246 - 394					
	275 - 325			230 - 295					
	325 - 375			197 - 246					
	375 - 425			148 - 180					
Stainless Steel	Martensitic	175 - 225		328 - 443					
		275 - 325		230 - 312					
	Austenitic	135 - 175		164 - 213					
Cast Steel	Carbon	> 150		344 - 443					
		150 - 200		279 - 328					
	Alloyed	200 - 250		246 - 295					
Malleable Iron	Short chip	110 - 145	295 - 328						
	Long chip	200 - 250	230 - 295						
Cast Iron	Low tensile	180	377 - 459		.004 - .010	.006 - .013	.008 - .016	.008 - .019	.008 - .024
	High tensile	250	262 - 328						
Nodular Iron	Ferritic	160	279 - 344						
	Pearlitic	250	262 - 328						
Chilled Cast Iron		400	66						
Bronze Alloy		120 - 200	361 - 394						
Lead Alloy		80 - 150	492 - 541						
Brass & Red		60 - 110	377 - 410						
Phosphor Bronze		85 - 110	262 - 295						
Aluminum Alloy		150 - 200	656 - 787						
Non-heat Treatable		30 - 80	1969 - 2297						
Heat-Treatable		80 - 120	820 - 984						
Aluminum Alloys, Cast			984 - 1115						
Magnesium		40 - 60 HRB	738 - 869						
		60 - 90 HRB	755 - 820						
Electrolytic Copper		50 - 85	295 - 328						

- For turning, increase cutting speed by 20 - 30%

GENERAL TECHNICAL INFORMATION

Advantage of the T-Clamp Ultra

- **T-Clamp** is available as either double-ended or single ended insert for maximum economy.
- Multifunctional use.
 - Right-hand and left-hand turning, grooving and parting with a single tool.
- **T-Clamp** replaces one or more ISO tools.
 - Reduces number of tools per operation.
 - Fewer insert and toolholder types in inventory.
- Shorter cycle time
 - Shorter setup with less downtime.
 - Reduces requirement for turret indexing.
- Less machining time
 - The excellent surface finish from rough turning may eliminate finish turning.

T-Clamp Ultra & T-Clamp Ultra Plus System vs. Standard ISO System

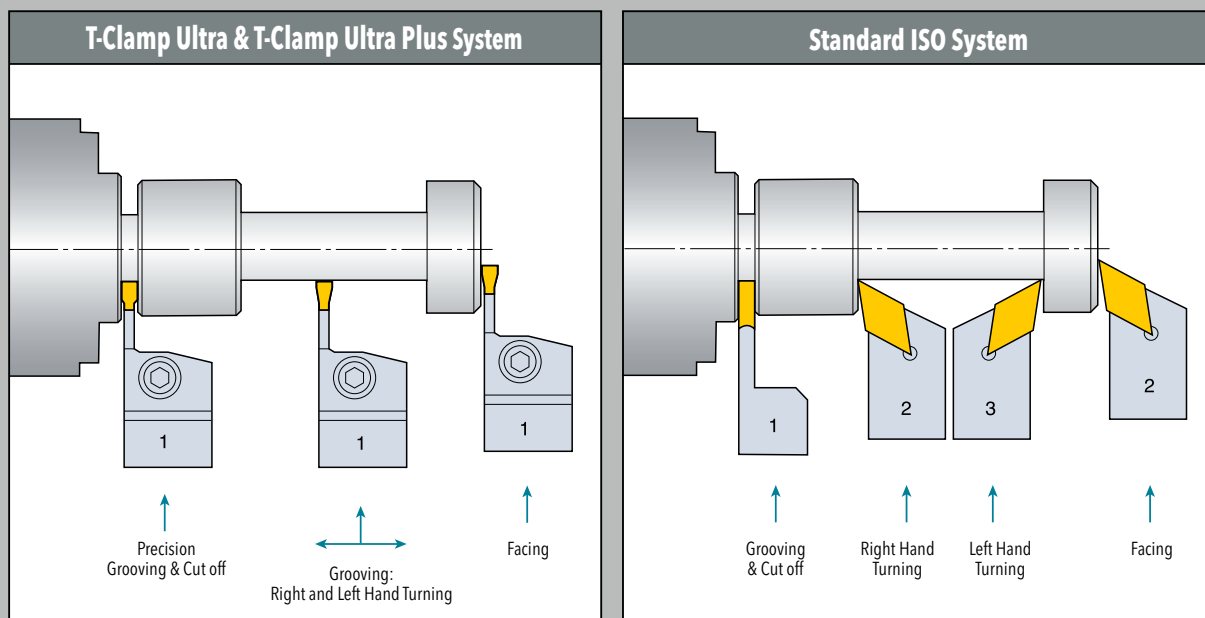

GENERAL TECHNICAL INFORMATION

Machining

- Consistency of speed and feed improves performance.
- Apply coolant abundantly (excluding Ceramic AB30).
- Secure insert into clean pockets.
- Cutting forces on soft workpiece materials may be insufficient to push insert well into pocket. Tap insert into place using a plastic hammer.
- On a conventional lathe, lock the carriage to prevent axial motion during cut off.

Usage

- Replace worn inserts promptly. The price of a new one is much less than the risk of damage from continuing with one that is worn out.
- Replace blades having worn or damaged pockets.
- Never try to repair damaged pockets.

Chipbreaker

The chipbreaker's function is to narrow the chip - it occurs near the cutting edge in the region of high temperature.

Producing chips that are narrower than the groove gives the following advantages :

- Eliminates frictions with groove walls
- Prevents chip overload
- Permits higher feeds
- Produces unscratched surfaces, eliminating additional facing.

Curling the chips into compact spirals or breaking them short is ideal for easy disposal.

Curling is affected by the chipbreaker type and the machining conditions.

Facilitate ease of cut by selection of an appropriate chipformer for the specific application.

Insertion and Extraction of Insert

T-Clamp Ultra Insert Clamping

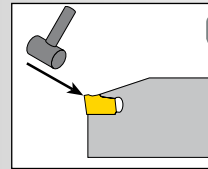

Insert mounting

By hand or with plastic hammer.

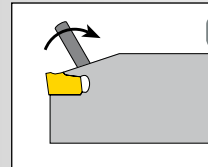

Insert Extraction

With extractor key.

GENERAL TECHNICAL INFORMATION

Nominal Cutting Speed (SFM) for Cut off & Grooving - T-Clamp Ultra

Chipbreaker ^①		TIMC																							
Width		1.6			2, 2.4			3			4.8, 5, 6				2		3		4.8, 6						
Grade		TT7200												TT5100											
Feed (ipr)		.002 .003 .005			.002 .004 .008			.004 .008 .012			.004 .008 .012 .016				.002 .004 .008		.004 .008 .012		.004 .008 .012 .016						
Workpiece Material	Brinell Hardness	Cutting Speed (SFM)																							
		Carbon 0.2 %C	150	460	460	425	490	490	425	560	460	425	590	525	440	395	430	430	360	475	395	360	490	440	380
Steel 0.45 %C	190	440	410	395	460	460	380	510	430	380	540	475	395	330	395	395	330	425	360	330	460	395	330	295	
	0.83 %C	250	360	360	330	410	410	280	440	360	—	475	395	330	—	360	360	295	380	310	260	395	330	280	230
Alloy Steel	200	360	360	330	410	410	280	440	360	310	475	395	330	250	360	360	295	380	310	260	395	330	280	230	
	200-250	310	310	280	360	360	200	360	310	250	395	345	280	200	310	310	230	310	260	250	330	295	260	200	
	275-325	295	295	260	345	345	180	345	295	—	380	330	260	—	295	295	215	295	245	200	280	250	230	150	
	325-375	230	230	200	260	260	—	260	230	—	260	250	200	—	230	230	130	230	200	—	230	215	165	—	
	375-425	150	150	—	180	180	—	180	150	—	260	165	—	—	165	165	—	165	130	—	165	150	—	—	
Martensitic Stainless Steel	175-225	425	360	330	490	330	230	460	330	260	525	425	—	—	420	405	330	475	390	280	490	460	360	—	
	275-325	345	345	295	360	360	—	410	345	—	440	395	295	—	295	295	—	345	295	210	380	330	245	—	
	375-425	165	165	—	165	165	—	180	130	—	195	165	—	—	165	165	—	265	115	—	180	130	—	—	
Austenitic	135-175	425	425	395	440	440	360	490	425	—	525	460	—	—	345	345	110	425	380	260	460	390	310	—	
Carbon Cast Steel	150	440	440	410	460	460	395	540	440	330	575	490	380	295	395	395	330	460	380	280	490	395	330	250	
Alloy	150-200	260	260	250	280	280	230	330	280	—	345	301	215	115	235	235	200	280	230	—	295	260	180	—	
	200-250	230	230	215	215	215	200	280	245	—	295	260	165	—	—	—	—	—	—	—	—	—	—	—	
	250-300	—	—	—	—	—	—	—	—	—	—	—	—	—	180	180	165	230	215	—	260	230	130	—	

① For TIMJ chipbreaker reduce feed by approximately 30%.

Iron-base Alloys (TIMC inserts)

Workpiece Material	Brinell Hardness	Feed (ipr)	Cutting Speed (SFM)	Carbide (Grade)
V57, A286	solution treated	.006-.008	98-130	P40A
Incoloy 800, 801	81 Rb	.004-.006	82-98	K10
	Solution aged	.006-.008	82-115	P40A
	24-34 Rc	.004-.006	65-80	K10
Austenitic Stainless Steel	Annealed	.004-.006	395-425	TT5100, P40A
302, 303, 304, 310, 316, 321, 347	135-175 HBN	.004-.006	590-625	TT7200, TT5100, P40A
Martens, Stainless Steel	Annealed	.004-.006	655-690	P40A
	135-175 HBN			
403, 405, 410, 420, 430, etc.	Q & T	.004-.006	360-394	P40A
	28-35 Rc	.004-.006	425-460	TT7200, TT5100, P40A
17-4PH	Solution treated	.004-.006	360-394	P40A
17-7PH	28-35 Rc	.004-.006	425-460	P40A
Maraging Steel, Maraging	Solution aged	.004-.006	195-260	TT7200, P40A
	36-40 Rc			
	Annealed	.006-.008	295-330	P40A
120, 180, 200, 250, 300,	26-34 Rc	.004-.006	360-390	TT7200, P40A
350	Maraged	.004-.006	165-200	P40A
120, 180	38-45 Rc	.004-.006	197-230	TT7200, P40A
	Maraged	.002-.004	65-100	K10
200, 250, 300, 350	50-52 Rc			

GENERAL TECHNICAL INFORMATION

Recommended Cutting Speed with ISO K Grades - T-Clamp Ultra

Cast Iron and Nonferrous Materials

Materials		Hardness Brinell HB	Grade K10
			Cutting Speed (sfm)
Carbon Steel	Low tensile, grey	180	200-265
	High tensile, grey, alloy	250	165-230
Malleable Iron	Short-Chipping	110-145	230-330
	Long-Chipping	200-250	230-295
Nodular Iron	Ferritic	160	200-280
	Pearlitic	250	150-250
	Chilled Cast Iron	400	50-80
Bronze	Lead Alloy	110	490-720
	Brass, Red brass	100	390-590
	Phosphor-bronze	100	330-460
Magnesium		40-90 HRB	820-885
Aluminum		40-90 HRB	820-1475

Nickel - base Alloys

Materials	Hardness Brinell HB	Grade K10
		Cutting Speed (sfm)
Astroloy, Rene41	Sol 240-300	65-100
Udimet 500, 700	S & A 310-400	50-80
Inconel W, X, 702, 718	Sol 240-300	50-100
M252, Waspaloy	S & A 400-410	50-80
Hastelloy	Annealed	80-130
	90-100 HRB	
Inconel 600	Cold drawn	65-115
	250-330	
TD2	Stress relieved 300	165-210

Titanium - base Alloys

Materials	Hardness Brinell HB	Grade K10
		Cutting Speed (sfm)
Ti5Al - 2.5Sn	Annealed 310-370	130-165
Ti6Al - 4V	Annealed 310-370	130-165
	S & A 370-410	80-130
Ti6Al - 6V - 2Sn	Annealed 380-420	100-135
Ti7Al - 4MO	S & A 380-420	100-130
Ti8AlMO - 1V		
TiA55	Annealed 110-175	460-525
Ti75A	Annealed 300-350	130-165
Ti140A		

Cobalt - base Alloys

Materials	Hardness Brinell HB	Grade K10
		Cutting Speed (sfm)
HS21, HS31, HS36	As Cast 90-98 HRB	65-80
L605	Sol 90-98 HRB	65-80
	S & A 280-330	50-65
Stellite 6	370-420	50-65

S & A-Solution and aging
Sol-Solution treatment

GENERAL TECHNICAL INFORMATION

Recommended Machining Conditions For Turning and Grooving - T-Clamp Ultra

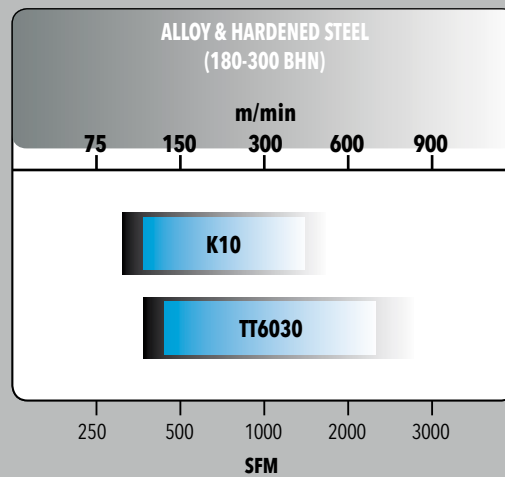
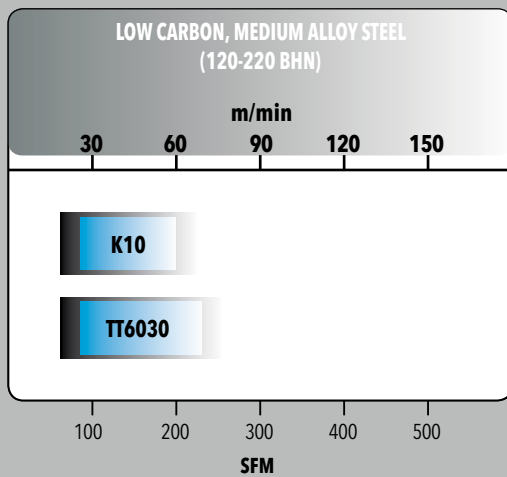
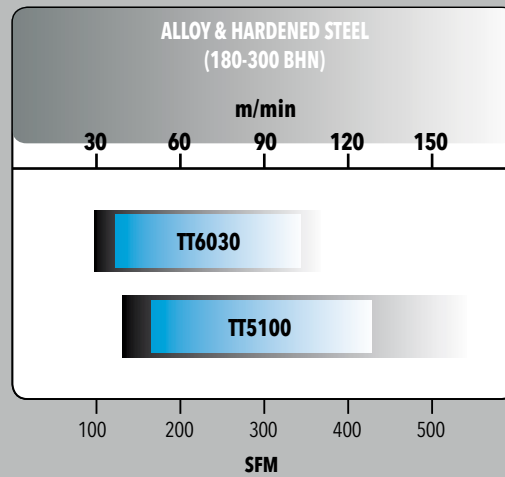
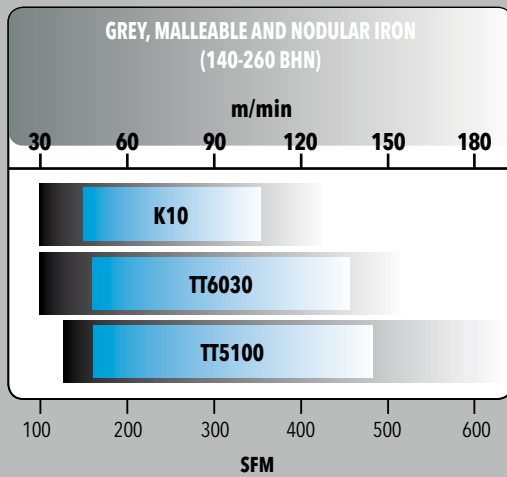
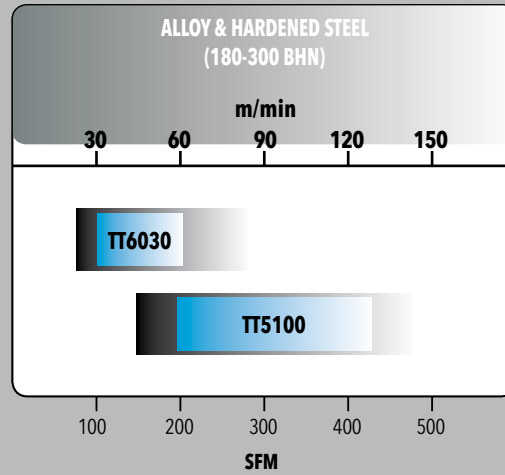
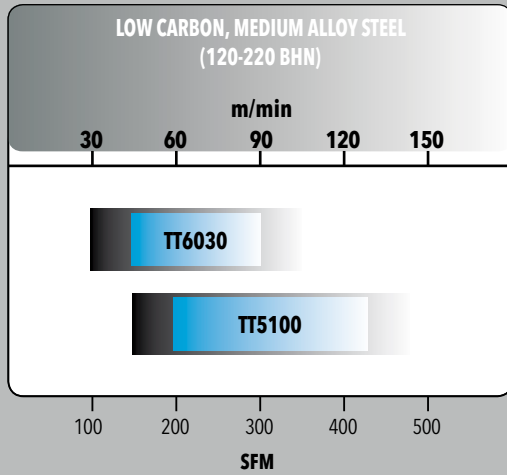

 Normal Operating Range Shown in Light Blue

GENERAL TECHNICAL INFORMATION

T-Clamp Ultra and Ultra Plus Grades

TaeguTec Grade	ISO	Characteristics	Application
P40A Uncoated	P30 - P50	<ul style="list-style-type: none"> Suitable for parting at medium speeds and large feeds in unfavorable conditions. For steel, steel castings with cavities. 	Cut off and Grooving
K10 Uncoated	K10 - K20	<ul style="list-style-type: none"> For semi-finishing and finishing at medium cutting speeds and feeds. For cast iron, malleable cast iron, aluminum, copper alloys. 	Cut off, Grooving and Turning
TT7200 CVD Coated	P20 - P40	<ul style="list-style-type: none"> For semi-finishing and roughing at medium cutting speeds and feeds. For carbon steel, alloy steel, steel castings, malleable cast iron. TiC-TiCN-TiN 	Cut off and Grooving
TT5100 CVD Coated	P20 - P40 M15 - M35 S10 - S20	<ul style="list-style-type: none"> Excellent chipping resistance and adhesion resistance. For medium turning of low carbon steel, low carbon alloy steel and stainless steel. TiC-TiCN-Al₂O₃-TiN 	Turning and Grooving
TT7220 PVD Coated	P20 - P35	<ul style="list-style-type: none"> For semi-roughing and medium cutting of steel. For carbon steel, alloy steel. TiCN 	Cut off, Grooving and Turning
TT8020 PVD Coated	P30 - P45 M30 - M40 N15 - N30 S20 - S30	<ul style="list-style-type: none"> Toughest grade in all T-Cut grades. First choice for interrupted cut on stainless steel and exotic alloy. 	Cut off and Grooving
TT9030 PVD Coated	P15 - P35 M10 - M30 K10 - K30 S15 - S25	<ul style="list-style-type: none"> High mechanical shock resistance. For semi-roughing and medium cutting of steel and stainless steel. For high speed machining of gray cast iron and ductile cast iron. TiAlN coated on sub-micron grade. 	Cut off and Grooving
TT6030 PVD Coated	K05 - K20	<ul style="list-style-type: none"> High wear resistance. For medium and high speed machining of gray cast iron and ductile cast iron. 	Turning and Grooving
CT3000 Cermet	P05 - P15 M05 - M15 K05 - K15	<ul style="list-style-type: none"> Suitable for finishing to semi-finishing of steel, cast iron and stainless steel. General turning and grooving of steel. 	Cut off, Grooving and Turning
AB30 Ceramic	K05 - K15 H05 - H15	<ul style="list-style-type: none"> For high speed machining of cast iron and high hardness material. Can be applied for interrupted cut. 	Cut off, Grooving and Turning
KB50 CBN	H01 - H05	<ul style="list-style-type: none"> For high speed machining of hardened steel in finishing. 	Turning and Grooving
KP300 PCD	N05 - N15	<ul style="list-style-type: none"> For high speed machining of low Si aluminum alloy. 	Turning and Grooving

GENERAL TECHNICAL INFORMATION

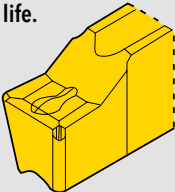
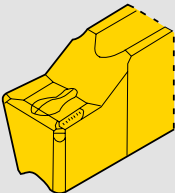
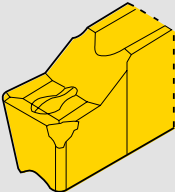
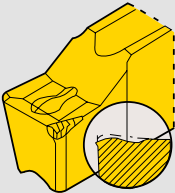

TROUBLE SHOOTING

Problem	Possible Cause	Solution
<p>1. Rapid flank wear reduces tool life.</p> 	<p>Excessively high cutting speed. Carbide with too low wear resistance.</p>	<ul style="list-style-type: none"> • Decrease cutting speed. • Use a carbide with higher hardness or a coated carbide
<p>2. Cratering reduces tool life</p> 	<p>High cutting temperature on insert rake face due to high feed and speed</p>	<ul style="list-style-type: none"> • Decrease feed and speed. • Use coated grade.
<p>3. Cutting edge / Insert fracture</p> 	<p>High load on insert. Insert width too narrow. Grade too brittle.</p>	<ul style="list-style-type: none"> • Use wider insert for maximum support. • Decrease feed and speed. • Choose a tougher grade.
<p>4. Plastic deformation</p> 	<p>High heat pressure decreasing carbide hardness</p>	<ul style="list-style-type: none"> • Use a bigger corner radius and decrease feed and speed. • Choose carbide with higher hardness.
<p>5. Chip control. Spaghetti-like chips coil under holder and interfere with operation</p>	<p>Small depth of cut. Feed too slow. Insert width too large. Insert radius too large.</p>	<ul style="list-style-type: none"> • Check chipbreaking range. • Increase depth of cut. • Increase feed rate. • Use narrower insert with a smaller radius.
<p>6. Poor surface finish</p>	<p>Small depth of cut, i.e. less than corner radius.</p>	<ul style="list-style-type: none"> • Increase depth of cut to minimum radius size.
<p>7. Vibration and poor surface quality</p>	<p>Small front clearance angle between insert and workpiece leads to rubbing action.</p>	<ul style="list-style-type: none"> • Increase feed to get suitable clearance. • Before starting, check that the front cutting edge is parallel to workpiece.

Ingersoll

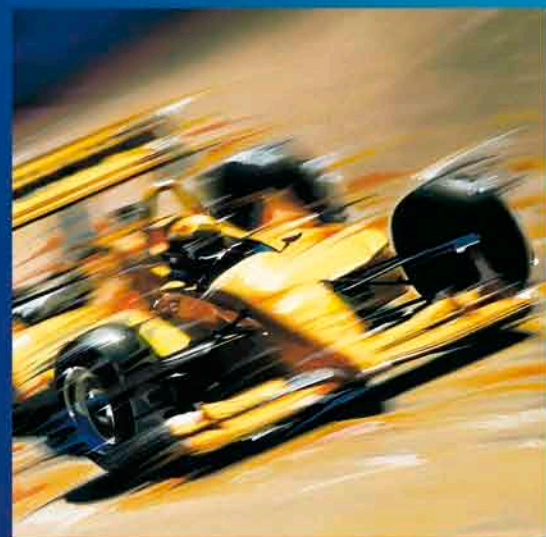

T-CAP.

Cutting Tools



Member IMC Group
Ingersoll
Cutting Tools

T-CAP.

	Designation	Description	Page
	TOCAP TCAP R/L	Holders, Standard Shanks	1380
	TOCAP TCAP R/L-M	Holders, Metric Shanks	1381
	TOCAP TCAP R/L 3:1	Holders, Inch Shanks, Heavy Metal 3:1	1381
	TOCAP TGHR	Clamping Units (Center Alignment System)	1384
	TOCAP XCMT	General Purpose Machining	1382
	TOCAP XCGT	"TA" Insert for Aluminum Machining	1383
	TOCAP TSL	Sleeves for Clamping Units	1385
	TOCAP T-CAP MULTIFUNCTIONAL TOOLS IN A CONVENIENT KIT	Each Kit Contains: T-Cap Holder (1), XCMT Inserts (10), Insert Screws (5), Driver (1)	1386

HOLDERS, STANDARD SHANKS

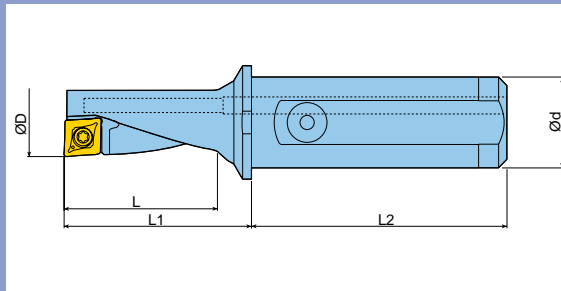

Designation	D (inch)	d (inch)	L (inch)	L1 (inch)	L2 (inch)	Accepts Insert Series	Insert Screw	Torx Driver
TCAP08L-2.25DN-IN	0.315	0.375	0.708	0.866	1.500	XC_T 0401_	TS18034I/HG-P	T6P
TCAP08R-2.25DN-IN	0.315	0.375	0.708	0.866	1.500	XC_T 0401_	TS18034I/HG-P	T6P
TCAP10L-2.25DN-IN	0.394	0.500	0.886	1.083	1.650	XC_T 0502_	TS20038I/HG-P	T6P
TCAP10R-2.25DN-IN	0.394	0.500	0.886	1.083	1.650	XC_T 0502_	TS20038I/HG-P	T6P
TCAP12L-2.25DN-IN	0.472	0.625	1.063	1.300	1.770	XC_T 0602_	TS22052I/HG-P	T7P
TCAP12R-2.25DN-IN	0.472	0.625	1.063	1.300	1.770	XC_T 0602_	TS22052I/HG-P	T7P
TCAP14L-2.25DN-IN	0.551	0.625	1.240	1.516	1.770	XC_T 0703_	TS25064I/HG-P	T8P
TCAP14R-2.25DN-IN	0.551	0.625	1.240	1.516	1.770	XC_T 0703_	TS25064I/HG-P	T8P
TCAP16L-2.25DN-IN	0.630	0.750	1.417	1.732	1.970	XC_T 0803_	TS30100I/HG-P	TD9P
TCAP16R-2.25DN-IN	0.630	0.750	1.417	1.732	1.970	XC_T 0803_	TS30100I/HG-P	TD9P
TCAP20L-2.25DN-IN	0.787	1.000	1.772	2.165	2.200	XC_T 10T3_	TS35088I/HG-P	T10P
TCAP20R-2.25DN-IN	0.787	1.000	1.772	2.165	2.200	XC_T 10T3_	TS35088I/HG-P	T10P
TCAP25L-2.25DN-IN	0.984	1.250	2.224	2.716	2.402	XC_T 1304_	TS45A100I/HG	T20
TCAP25R-2.25DN-IN	0.984	1.250	2.224	2.716	2.402	XC_T 0401_	TS45A100I/HG	T20
TCAP32R-2.25DN-IN	1.260	1.500	2.835	3.386	2.910	XC_T 1705_	TS45A100I/HG	T20

TOCAP™ TCAP R/L-M

HOLDERS, METRIC SHANKS

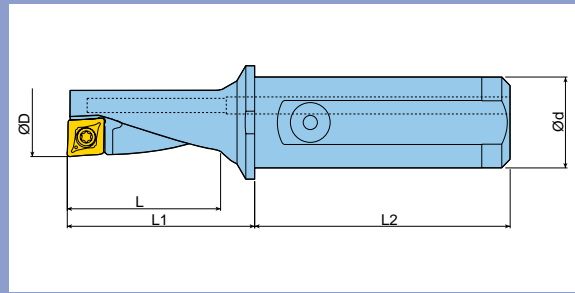

Designation	D (mm)	d (mm)	L (mm)	L1 (mm)	L2 (mm)	Accepts Insert Series	Insert Screw	Torx Driver
TCAP08L-2.25DN	8.000	10.000	18.000	22.000	38.000	XC_T 0401_	TS18034I/HG-P	T6P
TCAP08R-2.25DN	8.000	10.000	18.000	22.000	38.000	XC_T 0401_	TS18034I/HG-P	T6P
TCAP10L-2.25DN	10.000	12.000	22.500	27.500	42.000	XC_T 0502_	TS20038I/HG-P	T6P
TCAP10R-2.25DN	10.000	12.000	22.500	27.500	42.000	XC_T 0502_	TS20038I/HG-P	T6P
TCAP12L-2.25DN	12.000	16.000	27.000	33.000	45.000	XC_T 0602_	TS22052I/HG-P	T7P
TCAP12R-2.25DN	12.000	16.000	27.000	33.000	45.000	XC_T 0602_	TS22052I/HG-P	T7P
TCAP14L-2.25DN	14.000	16.000	31.500	38.500	45.000	XC_T 0703_	TS25064I/HG-P	T8P
TCAP14R-2.25DN	14.000	16.000	31.500	38.500	45.000	XC_T 0703_	TS25064I/HG-P	T8P
TCAP16L-2.25DN	16.000	20.000	36.000	44.000	50.000	XC_T 0803_	TS30100I/HG-P	TD9P
TCAP16R-2.25DN	16.000	20.000	36.000	44.000	50.000	XC_T 0803_	TS30100I/HG-P	TD9P
TCAP20L-2.25DN	20.000	25.000	45.000	55.000	56.000	XC_T 10T3_	TS35088I/HG-P	T10P
TCAP20R-2.25DN	20.000	25.000	45.000	55.000	56.000	XC_T 10T3_	TS35088I/HG-P	T10P
TCAP25R-2.25DN	25.000	32.000	56.500	69.000	65.000	XC_T 1705_	TS35088I/HG-P	T20

TOCAP™ TCAP R/L 3:1

HOLDERS, INCH SHANKS, HEAVY METAL 3:1

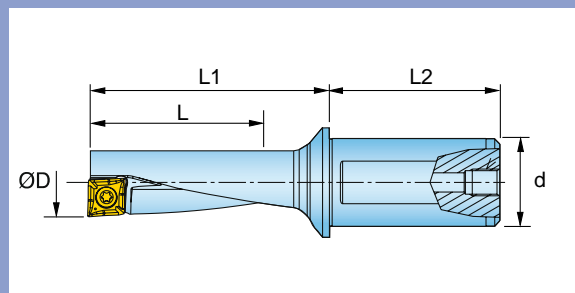

Designation	D (inch)	d (inch)	L (inch)	L1 (inch)	L2 (inch)	Accepts Insert Series	Insert Screw	Torx Driver
TCAP08R-3.0DN12.7	0.315	0.500	0.944	1.150	2.000	XC_T 0401_	TS18034I/HG-P	T6P
TCAP10R-3.0DN12.7	0.394	0.500	1.181	1.335	2.010	XC_T 0502_	TS20038I/HG-P	T6P
TCAP12R-3.0DN15.88	0.472	0.625	1.417	1.583	2.160	XC_T 0602_	TS22052I/HG-P	T7P
TCAP14R-3.0DN15.88	0.551	0.625	1.654	1.874	2.060	XC_T 0703_	TS25064I/HG-P	T8P
TCAP16R-3.0DN19.05	0.630	0.750	1.890	2.134	2.200	XC_T 0803_	TS30100I/HG-P	TD9P
TCAP20R-3.0DN25.4	0.787	1.000	2.362	5.120	2.449	XC_T 10T3_	TS35088I/HG-P	TD10P



GENERAL PURPOSE MACHINING

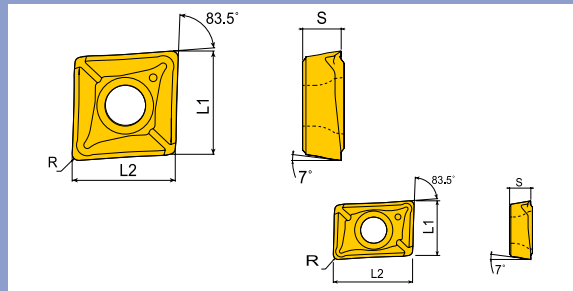

ANSI Number	ISO Number	L1	L2	t	R	Grade	TT6030	TT8020	TT9030
XCMT040104LTC	XCMT040104LTC	0.173	0.252	0.067	0.016		●	●	
XCMT040104RTC	XCMT040104RTC	0.173	0.252	0.067	0.016		●	●	
XCMT050204TC	XCMT050204TC	0.220	0.220	0.083	0.016		●	●	
XCMT060204TC	XCMT060204TC	0.252	0.252	0.094	0.016		●	●	
XCMT070304TC	XCMT070304TC	0.295	0.295	0.125	0.016		●	●	
XCMT080304TC	XCMT080304TC	0.331	0.331	0.125	0.016		●	●	
XCMT10T304TC	XCMT10T304TC	0.413	0.413	0.156	0.016		●	●	
XCMT10T308TC	XCMT10T308TC	0.413	0.413	0.156	0.031		●	●	
XCMT130404 TC	XCMT130404TC	0.528	0.528	0.187	0.016		●		
XCMT130408TC	XCMT130408TC	0.528	0.528	0.187	0.031			●	
XCMT170508TC	XCMT170508TC	0.685	0.685	0.219	0.031			●	

● = P ● = M ● = K ● = N ● = S ○ = H

"TA" INSERT FOR ALUMINUM MACHINING

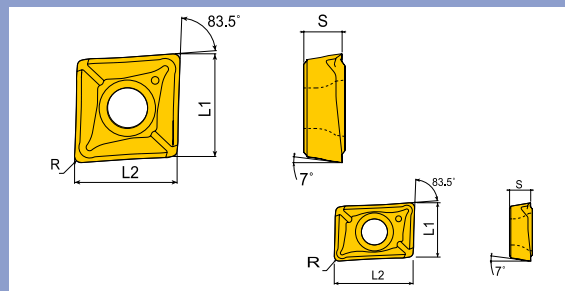

ANSI Number	ISO Number	L1	L2	t	R	Grade	K10			
XCGT040104LTA	XCGT040104LTA	0.252	0.173	0.187	0.016	●●●				
XCGT040104RTA	XCGT040104RTA	0.252	0.173	0.187	0.016	●●●				
XCGT050204TA	XCGT050204TA	0.225	0.220	0.083	0.016	●●●				
XCGT060204TA	XCGT060204TA	0.252	0.252	0.094	0.016	●●●				
XCGT070304TA	XCGT070304TA	0.295	0.295	0.125	0.016	●●●				
XCGT080304TA	XCGT080304TA	0.331	0.331	0.125	0.016	●●●				
XCGT10T304TA	XCGT10T304TA	0.413	0.413	0.156	0.016	●●●				
XCGT130404TA	XCGT130404TA	0.528	0.528	0.187	0.016	●●●				
XCGT170508TA	XCGT170508TA	0.689	0.689	0.219	0.031	●●●				

● = P ● = M ● = K ● = N ● = S ○ = H

CLAMPING UNITS (CENTER ALIGNMENT SYSTEM)

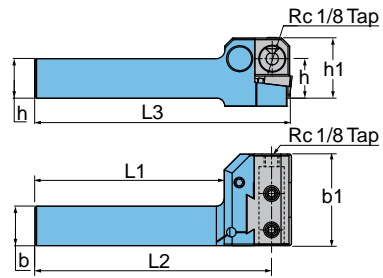

Designation	h (inch)	b (inch)	D (inch)	h1 (inch)	b1 (inch)	L1 (inch)	L2 (inch)	L3 (inch)
TGHR19.05-D15.88	0.750	0.750	0.625	1.500	2.280	4.720	5.910	6.340
TGHR25.4-D15.88	1.000	1.000	0.625	1.500	2.280	4.720	5.910	6.340
TGHR25.4-D25.4	1.000	1.000	1.000	2.200	2.950	4.720	6.180	6.850

Designation	HARDWARE									
	Block	Wedge	Snap Ring	Wedge Screw	Mounting Pin	Mounting Pin Screw	Mounting Screw	Mounting Screw	Lock Screw	Wrench
TGHR19.05-D15.88	TGHR-D16-BL	TGHR-WD	WSR 4	TGH-WS	TGH-MPI	TGH-MPS	SSXMBX1,25X10-C	SSXMBX1,25X8-C	-	L-W4
TGHR25.4-D15.88	TGHR-D16-BL	TGHR-WD	WSR 4	TGH-WS	TGH-MPI	TGH-MPS	SSXMBX1,25X10-C	SSXMBX1,25X8-C	-	L-W4
TGHR25.4-D25.4	TGHR-D25-BL	TGHR-WD-25	WSR 4	TGH-WS-25	TGH-MPI-25	TGH-MPS-25	SSXMBX1,25X12-C	SSXMBX1,5X10-C	SHM6X1X20	L-W4/L-W5

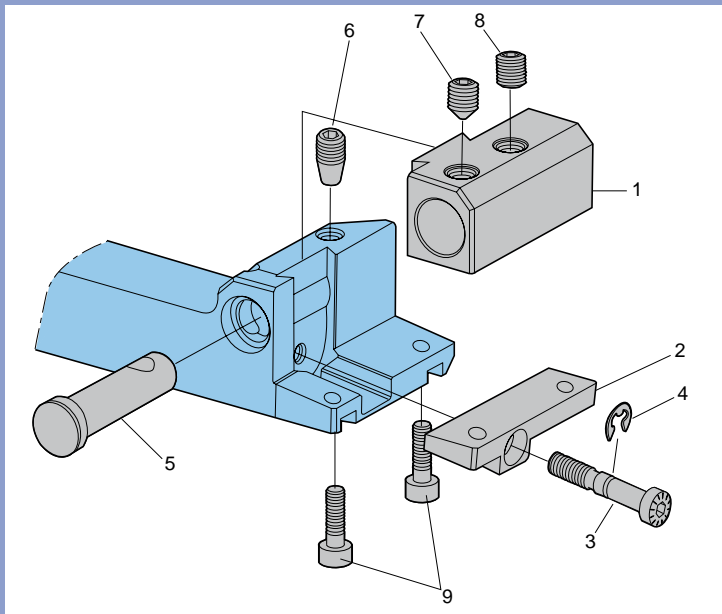

Number	Hardware
1	Block
2	Wedge
3	Snap Ring
4	Wedge Screw
5	Mounting Pin
6	Mounting Pin Screw
7	Mounting Screw
8	Mounting Screw
9	Lock Screw

SLEEVES FOR CLAMPING UNITS

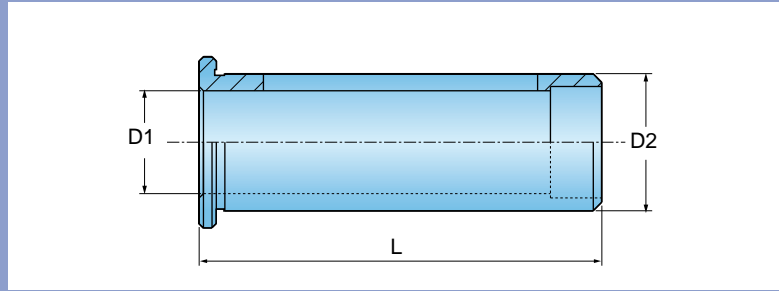

Designation	D (inch)	D1 (mm/inch)	L (inch)	Toolholder (for metric shanks)
Into to Metric				
TSL19.05-10	0.75	10mm	2.00	TCAP08R/L
TSL19.05-12	0.75	12mm	2.00	TCAP10R/L
TSL25.4-10	1.00	10mm	2.75	TCAP08R/L
TSL25.4-12	1.00	12mm	2.75	TCAP10R/L
TSL25.4-16	1.00	16mm	2.75	TCAP12R/L or 14R/L
TSL25.4-20	1.00	20mm	2.75	TCAP16R/L
TSL31.75-10	1.25	10mm	3.25	TCAP08R/L
TSL31.75-12	1.25	12mm	3.25	TCAP10R/L
TSL31.75-16	1.25	16mm	3.25	TCAP12R/L or 14R/L
TSL31.75-20	1.25	20mm	3.25	TCAP16R/L
TSL31.75-25	1.25	25mm	3.25	TCAP20R/L
TSL38.1-10	1.50	10mm	3.38	TCAP08R/L
TSL38.1-12	1.50	12mm	3.38	TCAP10R/L
TSL38.1-16	1.50	16mm	3.38	TCAP12R/L or 14R/L
TSL38.1-20	1.50	20mm	3.38	TCAP16R/L
TSL38.1-25	1.50	25mm	3.38	TCAP20R/L
TSL50.8-25	2.00	25mm	4.32	TCAP20R/L
Into to Inch				
TSL15.88-9.52	0.625	0.375"	1.85"	TCAP08R/L (-IN)
TSL15.88-12.7	0.625	0.500"	1.85"	TCAP10R/L (-IN)
TSL25.4-19.05	1.00	0.750"	1.85"	TCAP08R/L (-IN)

T-CAP MULTIFUNCTIONAL TOOLS IN A CONVENIENT KIT

EACH KIT CONTAINS: T-CAP HOLDER (1), XCMT INSERTS (10), INSERT SCREWS (5), DRIVER (1)



Designation	Kit Item Number	Description
3104037	KITCAP08R-2.25D TT9030	8 mm diameter, 10 mm shank
3104038	KITCAP10R-2.25D TT9030	10 mm diameter, 12 mm shank
3104039	KITCAP12R-2.25D TT9030	12 mm diameter, 16 mm shank
3104040	KITCAP14R-2.25D TT9030	14 mm diameter, 16 mm shank
3104041	KITCAP16R-2.25D TT9030	16 mm diameter, 20 mm shank
3104042	KITCAP20R-2.25D TT9030	20 mm diameter, 25 mm shank

Designation	Kit Item Number	Description
3104043	KITCAP08R-2.25DIN TT9030	8 mm diameter, .375" shank
3104044	KITCAP10R-2.25DIN TT9030	10 mm diameter, .500" shank
3104064	KITCAP12R-2.25DIN TT9030	12 mm diameter, .625" shank
3104065	KITCAP14R-2.25DIN TT9030	14 mm diameter, .625" shank
3104066	KITCAP16R-2.25DIN TT9030	16 mm diameter, .750" shank
3104067	KITCAP20R-2.25DIN TT9030	20 mm diameter, 1.00" shank
3104068	KITCAP25R-2.25DIN TT9030	25 mm diameter, 1.25" shank
3004079	KITCAP32R-2.25DIN TT9030	32 mm diameter, 1.50" shank



Ingersoll



CUTTING TOOLS
CUTTING TOOLS

TECHNICAL INFORMATION.

Cutting Tools

GENERAL TECHNICAL INFORMATION



MULTI-FUNCTION SYSTEM

- Turning, boring and drilling with one tool
- Short set-up and cycle time
- Minimized tool positions and reduced tooling cost

APPLICATION

- Conventional

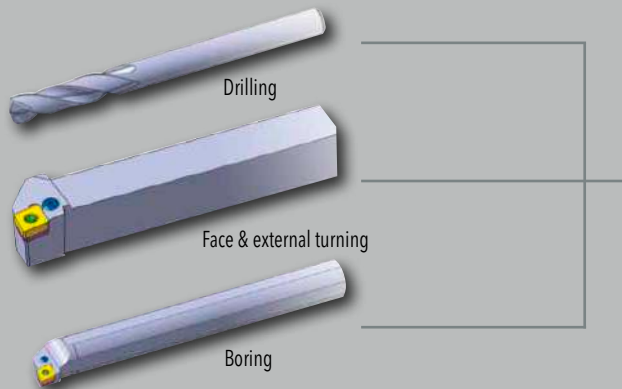

T-CAP

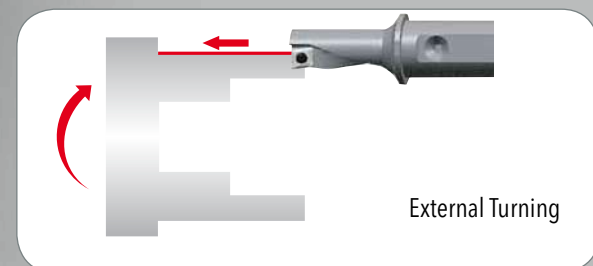
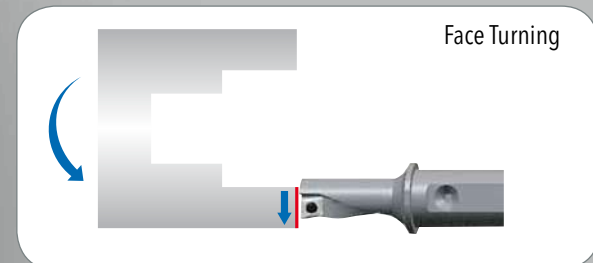
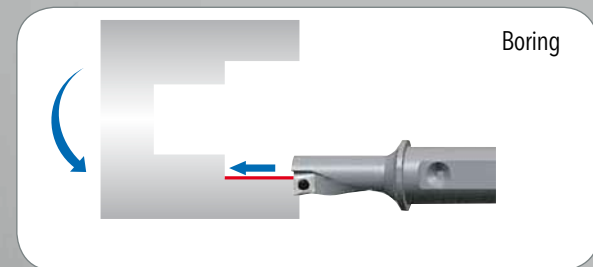
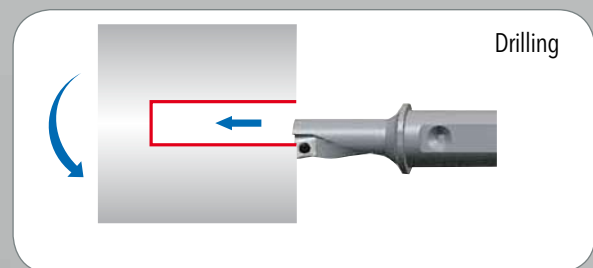
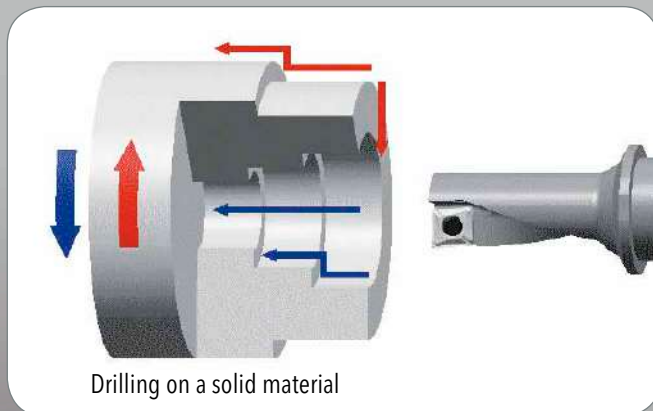

GENERAL TECHNICAL INFORMATION

TOCAP™

SET-UP

Insert positioning

- Cutting edge for drilling should be positioned in the center of tool body

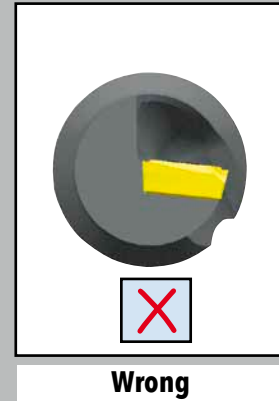
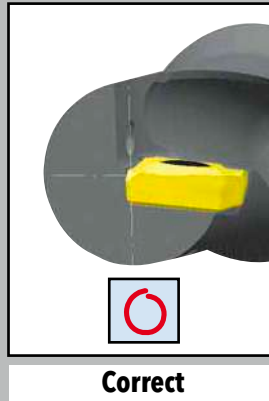
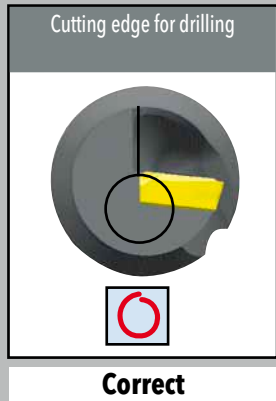

Coolant pressure

- Must be above 20psi, optimal pressure is above 70psi

Optimization of chip shape

• Material with low carbon content

High speed machining is recommended to make the chips thinner as many problems are caused by thick chips

• Material with medium to high carbon content

If too tight (thick chip?) increase speed if the speed is slow or reduce feed / If too loose (long chip?) reduce speed if the speed is high or increase feed.

SET-UP

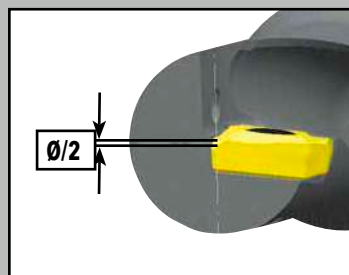
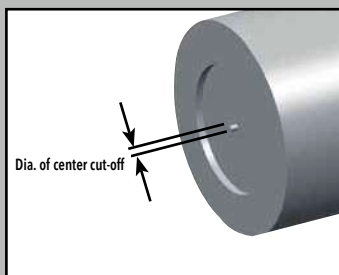

Please check formation of core and its size after drilling .125" to .250" depth and diameter core should be within .006"-.018"

If you are using a clamping unit, adjustment is easy and accurately performed by adjusting the Y-axis of the clamping unit

• If a core does not appear

It can cause breakage of inserts and vibration when drilling or turning

• If the size of core is over the recommendation

It will cause overload and vibration

GENERAL TECHNICAL INFORMATION



RADIAL ADJUSTMENT

(in)

Radial adjustment is dependent on drill diameter

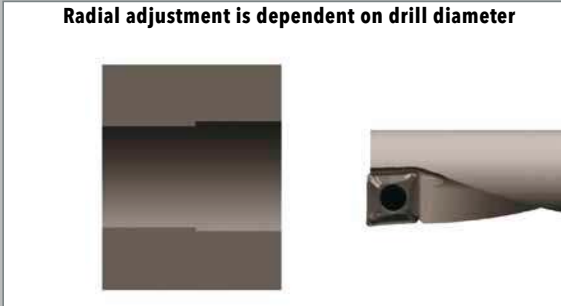

Tool Holder	Drill Dia.	Dmin	Dmax
TCAP 08 -	8	.310	.329
TCAP 10 -	10	.390	.417
TCAP 12 -	12	.465	.496
TCAP 14 -	14	.543	.574
TCAP 16 -	16	.620	.650
TCAP 20 -	20	.780	.811
TCAP 25 -	25	.974	.992
TCAP 32 -	32	1.252	1.266

RECOMMENDED CUTTING CONDITIONS CUTTING SPEED (Vc)

Material	Hardness (BHN)	Cutting Speed: Vc (sfm)	
		In Drilling	In Turning & Boring
Low Carbon Steel (-0,25% C)	- 150	430 - 790	490 - 890
Carbon Steel (0,25% < C)	150 - 250	300 - 520	330 - 590
Low Alloy Steel	-180	390 - 690	460 - 750
Medium Alloy Steel	200 - 250	230 - 460	260 - 300
High Alloy Steel	250 - 350	160 - 330	200 - 390
Martensitic Stainless Steel	200	360 - 590	460 - 650
Austenitic Stainless Steel	200	300 - 520	330 - 590
Gray Cast Iron	180 - 220	360 - 590	390 - 560
Ductile Cast Iron	200 - 240	300 - 520	330 - 590
Aluminum Alloy	60 - 130	330 - 1640	490 - 1970
Copper Alloy	90 - 100	330 - 1310	330 - 1640

FEED (f)

Designation	Application	Cutting Conditions	
		ap (in)	f (IPR)
XCMT 040104	External turning	.023 (.007 - .070)	.002 (.0007 - .006)
	Drilling	-	.002 (.007 - .004)
XCMT 050204	External turning	.031 (.007 - .087)	.003 (.001 - .007)
	Drilling	-	.002 (.0007 - .005)
XCMT 060204	External turning	.040 (.012 - .100)	.003 (.001 - .008)
	Drilling	-	.003 (.001 - .005)
XCMT 070304	External turning	.047 (.016 - .110)	.005 (.002 - .009)
	Drilling	-	.003 (.001 - .006)
XCMT 080304	External turning	.060 (.016 - .125)	.005 (.002 - .010)
	Drilling	-	.003 (.001 - .006)
XCMT 10T304	External turning	.070 (.020 - .138)	.005 (.002 - .012)
	Drilling	-	.003 (.001 - .006)
XCMT 10T308	External turning	.070 (.020 - .138)	.008 (.004 - .016)
	Drilling	-	.003 (.002 - .006)
XCMT 130404	External turning	.080 (.023 - .150)	.006 (.002 - .014)
	Drilling	-	.004 (.002 - .007)
XCMT 130408	External turning	.080 (.023 - .170)	.008 (.004 - .016)
	Drilling	-	.003 (.002 - .006)
XCMT 170508	External turning	.087 (.023 - .165)	.006 (.003 - .016)
	Drilling	-	.004 (.002 - .008)

INDEX

Designation	Page	Designation	Page	Designation	Page
1240	1134	08IR16W	1214	11ELA55	1184
1250	1126	08IR18NPT	1219	11ELA60	1186
1335	1067	08IR18NPTF	1221	11ER0.35ISO	1189
1425	1126	08IR18UN	1204	11ER0.40ISO	1189
1440	1126	08IR18W	1214	11ER0.45ISO	1189
1540	1065	08IR19W	1214	11ER0.50ISO	1189
1750	1067	08IR20UN	1204	11ER0.60ISO	1189
1760	1065	08IR20W	1214	11ER0.70ISO	1189
3414	1075	08IR24UN	1204	11ER0.75ISO	1189
3614	1065	08IR24W	1214	11ER0.80ISO	1189
3714	1067	08IR27NPT	1219	11ER1.00ISO	1189
3718	1078	08IR27NPTF	1221	11ER1.25ISO	1189
3811	1072	08IR28UN	1204	11ER1.50ISO	1189
3814	1072	08IR28W	1214	11ER1.75ISO	1189
5507	1126	08IR32UN	1204	11ER14NPTF	1220
5515	1065	08IRA55	1185	11ER14UNJ	1229
5516	1067	08IRA60	1187	11ER14W	1209
5517	1065	08IRMA60	1187	11ER16ABUT	1235
06ILO.50ISO	1192	08UIRL11UN	1207	11ER16UN	1199
06ILO.75ISO	1192	08UIRL12UN	1207	11ER16UNJ	1229
06IL1.00ISO	1192	08UIRL13UN	1207	11ER16W	1209
06IL1.25ISO	1192	08UIRL14UN	1207	11ER18NPTF	1220
06IL18UN	1202	08UIRL2.00ISO	1197	11ER18UN	1199
06IL18W	1212	08UIRL2TR	1232	11ER18UNJ	1229
06IL20UN	1202	08UIRLU55	1185	11ER18W	1209
06IL20W	1212	08UIRLU60	1187	11ER19W	1209
06IL22W	1212	11ELO.35ISO	1188	11ER20ABUT	1235
06IL24UN	1202	11ELO.40ISO	1188	11ER20UN	1199
06IL26W	1212	11ELO.45ISO	1188	11ER20UNJ	1229
06IL27BSPT	1223	11ELO.50ISO	1188	11ER20W	1209
06IL27NPT	1219	11ELO.60ISO	1188	11ER22W	1209
06IL27NPTF	1221	11ELO.70ISO	1188	11ER24UN	1199
06IL28UN	1202	11ELO.75ISO	1188	11ER24UNJ	1229
06IL32UN	1202	11ELO.80ISO	1188	11ER24W	1209
06ILA55	1185	11EL1.00ISO	1188	11ER26W	1209
06ILA60	1187	11EL1.25ISO	1188	11ER27NPTF	1220
06IR18UN	1204	11EL1.50ISO	1188	11ER28UN	1199
06IR18W	1214	11EL1.75ISO	1188	11ER28UNJ	1229
06IR20UN	1204	11EL14NPTF	1220	11ER28W	1209
06IR20W	1214	11EL14UNJ	1228	11ER32UN	1199
06IR22W	1214	11EL14W	1208	11ER32UNJ	1229
06IR24UN	1204	11EL16ABUT	1235	11ER32W	1209
06IR26W	1214	11EL16UN	1198	11ER36UN	1199
06IR27NPT	1219	11EL16UNJ	1228	11ER36UNJ	1229
06IR27NPTF	1221	11EL16W	1208	11ER36W	1209
06IR28UN	1204	11EL18NPTF	1220	11ER40UN	1199
06IR32UN	1204	11EL18UN	1198	11ER40UNJ	1229
06IRA55	1185	11EL18UNJ	1228	11ER44UN	1199
06IRA60	1187	11EL18W	1208	11ER44UNJ	1229
06IRMA60	1187	11EL19W	1208	11ER48UN	1199
08ILO.50ISO	1192	11EL20ABUT	1235	11ER48UNJ	1229
08ILO.75ISO	1192	11EL20UN	1198	11ER48W	1209
08IL1.00ISO	1192	11EL20UNJ	1228	11ER56UN	1199
08IL1.25ISO	1192	11EL20W	1208	11ERA55	1184
08IL1.50ISO	1192	11EL22W	1208	11ERA60	1186
08IL1.75ISO	1192	11EL24UN	1198	11ILO.35ISO	1192
08IL14UN	1202	11EL24UNJ	1228	11ILO.40ISO	1192
08IL16UN	1202	11EL24W	1208	11ILO.45ISO	1192
08IL16W	1212	11EL26W	1208	11ILO.50ISO	1192
08IL18NPTF	1221	11EL27NPTF	1220	11ILO.60ISO	1192
08IL18UN	1202	11EL28UN	1198	11ILO.70ISO	1192
08IL18W	1212	11EL28UNJ	1228	11ILO.75ISO	1192
08IL19W	1212	11EL28W	1208	11ILO.80ISO	1192
08IL20UN	1202	11EL32UN	1198	11IL1.00ISO	1192
08IL20W	1212	11EL32UNJ	1228	11IL1.25ISO	1192
08IL24UN	1202	11EL32W	1208	11IL1.50ISO	1192
08IL24W	1212	11EL36UN	1198	11IL1.75ISO	1192
08IL27NPT	1219	11EL36UNJ	1228	11IL14BSPT	1223
08IL27NPTF	1221	11EL36W	1208	11IL14NPT	1219
08IL28UN	1202	11EL40UN	1198	11IL14NPTF	1221
08IL28W	1212	11EL40UNJ	1228	11IL14UN	1202
08IL32UN	1202	11EL44UN	1198	11IL14W	1212
08ILA55	1185	11EL44UNJ	1228	11IL16ABUT	1235
08ILA60	1187	11EL48UN	1198	11IL16UN	1202
08IR1.5TR	1231	11EL48UNJ	1228	11IL16W	1212
08IR14UN	1204	11EL48W	1208	11IL18NPT	1219
08IR16UN	1204	11EL56UN	1198	11IL18NPTF	1221

Designation	Page
11IL18UN	1202
11IL18W	1212
11IL19BSPT	1223
11IL19W	1212
11IL2.00ISO	1192
11IL20ABUT	1235
11IL20UN	1202
11IL20W	1212
11IL22W	1212
11IL24UN	1202
11IL24W	1212
11IL26W	1212
11IL27NPT	1219
11IL27NPTF	1221
11IL28BSPT	1223
11IL28UN	1202
11IL28W	1212
11IL32UN	1202
11IL32W	1212
11IL36UN	1202
11IL36W	1212
11IL40UN	1202
11IL48UN	1202
11IL48W	1212
11IL56UN	1202
11IL64UN	1202
11IL72UN	1202
11ILA55	1185
11ILA60	1187
11IR14NPT	1219
11IR14NPTF	1221
11IR14UN	1204
11IR14UNJ	1230
11IR14W	1214
11IR16ABUT	1235
11IR16UN	1204
11IR16UNJ	1230
11IR16W	1214
11IR18NPT	1219
11IR18NPTF	1221
11IR18UN	1204
11IR18UNJ	1230
11IR18W	1214
11IR19BSPT	1223
11IR19W	1214
11IR20ABUT	1235
11IR20UN	1204
11IR20UNJ	1230
11IR20W	1214
11IR22W	1214
11IR24UN	1204
11IR24UNJ	1230
11IR24W	1214
11IR26W	1214
11IR27NPTF	1221
11IR28BSPT	1223
11IR28UN	1204
11IR28UNJ	1230
11IR28W	1214
11IR32UN	1204
11IR32UNJ	1230
11IR32W	1214
11IR36UN	1204
11IR36UNJ	1230
11IR36W	1214
11IR40UN	1204
11IR40UNJ	1230
11IR44UNJ	1230
11IR48UN	1204
11IR48UNJ	1230
11IR48W	1214
11IR56UN	1204
11IR64UN	1204
11IR72UN	1204
11IRA55	1185
11IRA60	1187
11IRM1.50ISO	1196

Designation	Page
11IRMA60	1187
12J1D-0300587R01	14
12J1D-0300676R01	18
12J1D-03009R8R01	14
12J1D-04009S4R01	14
12J1D-05006T8R0	18
12J1D-05006T8R01	18
12J1D-05006T8R02	418
12J1D-0500979R01	14
12J1D-05009S4R01	14
12J1D-05010X4R01	17
12J1D-05011S4R01	14
12J1D-06008TR01	18
12J1D-06010X5R01	17
12J1D-0601479R01	14
12J1D-06014S6R01	14
12J1D-07007R8R01	16
12J1D-07010TSR01	18
12J1D-07010TSR02	18
12J1D-07015X6R01	17
12J1D-0701684R01	14
12J1D-0701684R02	14
12J1D-07016S7R01	14
12J1D-0801784R01	14
12J1D-10007R8R01	16
12J1D-10015X7R0	17
12J1D-1001780R01	14
12J1D-1001780R02	14
12J1D-1001784R02	14
12J1D-10021S1R01	14
12J1D-1003480R01	14
12J1D-12017X8R01	17
12J1D-15007S4R01	16
12J1D-15017X8R01	17
12J1D-20007S6R01	16
12J1E-0901780R01	38
12J1E-10015X7R01	40
12J1E-1001780R01	38
12J1E-1002780R01	38
12J1E-1003780R01	38
12J1E-1004029R01	38
12J1E-1005780R01	38
12J1E-12017X8R01	40
12J1E-1202281R01	38
12J1E-1202829R01	38
12J1E-1204281R01	38
12J1E-1206281R01	38
12J1E-1502281R01	38
12J1E-1502281R03	38
12J1E-1502829R01	38
12J1E-1504281R01	38
12J1E-2002281R01	38
12J1G-0701284R01	34
12J1G-1001580R01	34
12J1G-1001580R02	34
12J1G-10015X7R01	36
12J1G-1003780R01	34
12J1G-1006080R01	34
12J1G-1008080R01	34
12J1G-1201681R01	34
12J1G-1201681R02	34
12J1G-12017X8R01	36
12J1G-1204281R01	34
12J1G-1205281R01	34
12J1G-1207281R01	34
12J1G-1501681R01	34
12J1G-1501681R02	34
12J1G-1501681R03	34
12J1G-1501681R04	34
12J1G-1501881R01	34
12J1G-1501881R02	34
12J1G-1505586R01	34
12J1G-1507586R01	34
12J1G-1701781R01	34
12J1G-2001781R01	34
12J1P-0501379R01	20

Designation	Page
12J1P-0601379R01	20
12J1P-06015X5R01	22
12J1P-07015X6R01	22
12J1P-0701784R01	20
12J1P-0701784R02	20
12J1P-0702784R01	20
12J1P-0704084R01	20
12J1P-0801784R01	20
12J1P-10015X7R01	22
12J1P-1001784R01	20
12J1P-1001784R02	20
12J1P-1201584R01	20
12J1P-12017X8R01	22
12J1P-1501780R01	20
12J1R-0702084R01	32
12J1R-1001780R01	32
12J1R-1003780R01	32
12J1R-1202281R01	32
12J1R-1502281R01	32
12J1X-0701184R01	24
12J1X-07015X6R01	28
12J1X-0701784R01	24
12J1X-0702084R01	24
12J1X-0703084R01	24
12J1X-0705780R01	24
12J1X-0801784R01	24
12J1X-10015X7R01	28
12J1X-1001780R01	24
12J1X-1001784R01	24
12J1X-1003780R01	24
12J1X-1201780R01	24
12J1X-1201784R01	24
12J1X-12017X8R01	28
12J1X-1501784R01	24
12J1X-15017X8R01	28
12J1X-1502281R01	24
12J4E-1001780R01	38
12J4E-1002780R01	38
12J4E-1202281R01	38
12J4E-1204281R01	38
12J4E-1502281R01	38
12J4E-2002281R01	38
12M1D-0303287R01	222
12N1D-0303287R01	222
12P1D-0303287R01	222
12R1X-2001084R01	26
12T1B-1701981R01	234
12T1B-2102281R01	234
12V1X-07015X6R01	30
12V1X-10015X7R01	30
12V1X-10015X7R02	30
12V1X-12017X8R01	30
12W5F-030158R01	290
12W5F-030158R02	290
12W5H-05015S4R01	290
12W5H-05015S4R02	290
12W5K-06018S6R01	290
12W5K-06018S6R02	290
12W5M-07022S7R01	290
12W5M-07022S7R02	290
12W9F-03011X5R01	288
12W9F-03017S4R01	286
12W9H-05011X5R01	288
12W9H-05019S4R01	286
12W9K-06015S6R01	286
12W9K-06015X5R01	288
12W9K-06017X6R01	288
12W9M-07016X6R01	288
12W9M-07018S7R01	286
12W9M-07021X7R01	288
12W9R-10018S1R01	286
12W9R-10023X7R01	288
12W9R-10023X8R01	288
12W9S-12030S9R01	286
12Y1H-0301384R01	558
12Y1H-0301384R02	558
12Y1J-0500984R01	560

INDEX

Designation	Page
12Y1J-0501284R01	560
12Y1J-0501984R01	560
12Y1J-0601384R01	560
12Y1J-0701684R01	560
12Y1N-0701684R01	562
12Y1N-0903084R01	562
12Y1N-1102080R01	562
12Y1N-24019D1R01	572
12Y1S-1102080R01	564
12Y1S-1203780R01	564
12Y1S-1502881R01	564
12Y1S-1503781R01	564
12Y1S-24019D1R01	574
12Y1S-31021D3R01	574
12Y1S-39025D4R01	574
12Y1U-1703386R01	566
12Y1U-1903386R01	566
12Y1U-31023D3R01	576
12Y1U-39027D4R01	576
12Y5J-05044R8R01	568
12Y5J-06052S4R01	568
12Y5N-08060S6R01	570
15B1D016023X5R00	258
15B1D020030X6R00	258
15B1D025035X7R00	258
15B1E016023X5R00	258
15B1E030043X8R00	258
15B1E-07512X6R01	258
15B1F-0701784R01	244
15B1F-1001780R01	244
15B1F-1003780R01	244
15B1F-1201281R01	244
15B1F-1504281R01	244
15B1G020030X6R00	258
15B1G025035X7R00	258
15B1G030043X8R00	258
15B1G035043X8R00	258
15B1G042043X8R00	258
15B1G-10012X7R01	258
15B1G-15012X8R01	258
15B1H035043X8R00	258
15B1H042043X8R00	258
15B1H-10015X7R01	258
15B1H-12015X8R01	258
15B1H-15015X8R01	258
15B1K032043X8R00	258
15B1K-12015X8R01	258
15B4H-1002280R01	245
15B4H-10037S1R01	245
15B4H-1252781R01	245
15B4H-12537S9R01	245
15B4H-1502386R01	245
15B4H-15033S5R01	245
15B4J-10015X7R01	246
15B4J-12017X8R01	246
15B4J-15017X8R01	246
15B4M-15017X8R01	252
15B4M-1502586R01	252
15B4M-15035S5R01	252
15C1D-0400884R01	540
15C1D-0500884R01	540
15C1D-0601084R01	540
15C1D-0701084R01	540
15C1D-0701084R02	540
15C1E-0801284R01	540
15C1E-0801384R01	540
15C1G-1001580R01	540
15C1G-1102080R01	540
15C1G-1202080R01	540
15C1G-1302281R01	540
15C1G-1502281R01	540
15C1G-1503781R01	540
15C1G-1602581R01	540
15C1J-1702681R01	540
15C1J-2003081R01	540
15E1H-10015X7R01	278
15E1H-1001780R01	277

Designation	Page
15E1H-10020S1R01	277
15E1H-12015X8R01	278
15E1H-12020S9R01	277
15E1H-1202781R01	277
15E1H-15015X8R01	278
15E1H-15020S5R01	277
15E1H-1502386R01	277
15E1K-12017X8R01	278
15E1K-15017X8R01	278
15J1E-0601584R01	52
15J1E-0701784R01	52
15J1E-0703084R01	52
15J1E-1001780R01	52
15J1E-1003580R01	52
15J1E-1201780R01	52
15L1G-1502084R01	226
15M1G-1502084R01	226
15M1H-1001781R01	229
15N1E020035X7R00	224
15N1E-0201584R01	223
15N1E-10012X7R01	224
15N1E-12017X8R01	224
15N1F-0701584R00	227
15N1F-1001584R01	226
15N1F-1001780R00	227
15N1F-1201584R01	226
15N1F-2001940R00	227
15N1H-0802286R01	229
15N1H-1001180R00	228
15P1E-0201584R01	223
15R1V-0702084R01	230
15R1V-10015X7R01	231
15R1V-1002080R01	230
15R4H-10015X7R01	233
15R4H-1002080R01	232
15S1D-0500884R01	538
15S1D-0601084R01	538
15S1D-0701084R01	538
15S1D-0701284R01	538
15S1F-1001580R01	538
15S1G-0801284R01	538
15S1G-0801284R02	538
15S1G-1102080R01	538
15S1G-1202080R01	538
15S1G-1302281R01	538
15S1G-1502281R01	538
15S1J-1602381R01	538
15S1J-1702681R01	538
15S1J-2003081R01	538
15T1D-0902580R01	234
15T1F-1201280R01	234
15T1F-1401580R01	234
15U1G-10015X7R01	63
15U1G-1001780R01	62
15U1G-12017X8R01	63
15U1G-1202281R01	62
15U1G-15017X8R01	63
15U1G-1502281R01	62
15U1G-2002281R01	62
15V1D-07012X6R02	283
15V1D-07060S7R02	282
15V1D-10012X7R01	283
15V1D-10057S1R01	282
15V1D-12015X8R01	283
15V1E020030X6R00	262
15V1E025035X7R01	262
15V1E042043X8R00	262
15V1E-07012X6R01	262
15V1E-10012X7R01	262
15V1E-10012X7R02	262
15V1E-12015X8R01	262
15V1G-10012X7R01	283
15V1G-10057S1R01	282
15V1G-12015X8R01	283
15V1H-12015X8R01	262
15V1H-15017X8R01	262
15W4S-20017Z4R01	256

Designation	Page
15X1W-07013X6R01	57
15X1W-07020S1R01	54
15X1W-10017X7R01	57
15X1W-10020S1R01	54
15X1W-12017X8R01	57
15X1W-12020S9R01	54
15X1W-15017X8R01	57
15X1W-15040H5R01	56
15X1W-15040H7R01	56
15X1W-15040S5R01	54
15X1W-20040H5R01	56
15X1W-20040H7R01	56
15X1W-20055H5R01	56
15X1W-30040H5R01	56
15X1W-30040H7R01	56
15X1W-30055H5R01	56
15X1X-10020S1R01	58
15X1X-12017X8R01	59
15X1X-12020S9R01	58
15X1X-15018X8R01	59
15X1X-15040S5R01	58
15X1X-15040S9R02	58
15X1X-20040S2R01	58
15X1Z-2002581R01	60
15X1Z-2002581R02	60
15X1Z-2005548R01	60
15X1Z-20060S2R01	60
16ELO.35ISO	1188
16ELO.40ISO	1188
16ELO.45ISO	1188
16ELO.50ISO	1188
16ELO.60ISO	1188
16ELO.70ISO	1188
16ELO.75ISO	1188
16EL1.00ISO	1188
16EL1.25ISO	1188
16EL1.50ISO	1188
16EL1.5TR	1231
16EL1.75ISO	1188
16EL10ABUT	1235
16EL10ACME	1226
16EL10RND	1241
16EL10STACME	1224
16EL10UNJ	1228
16EL10W	1208
16EL11.5NPT	1218
16EL11.5NPTF	1220
16EL11BSPT	1222
16EL11UNJ	1228
16EL11W	1208
16EL12ABUT	1235
16EL12ACME	1226
16EL12STACME	1224
16EL12UNJ	1198
16EL12UNJ	1228
16EL12W	1208
16EL13UNJ	1228
16EL14ACME	1226
16EL14BSPT	1222
16EL14NPT	1218
16EL14NPTF	1220
16EL14STACME	1224
16EL14UNJ	1228
16EL14W	1208
16EL16ABUT	1235
16EL16ACME	1226
16EL16STACME	1224
16EL16UNJ	1198
16EL16UNJ	1228
16EL16W	1208
16EL18NPT	1218
16EL18NPTF	1220
16EL18UNJ	1198
16EL18UNJ	1228
16EL18W	1208
16EL19BSPT	1222
16EL19W	1208

Designation	Page
16EL2.00ISO	1188
16EL2.50ISO	1188
16EL20ABUT	1235
16EL20UN	1198
16EL20UNJ	1228
16EL20W	1208
16EL22W	1208
16EL24UNJ	1228
16EL24W	1208
16EL26W	1208
16EL27NPT	1218
16EL27NPTF	1220
16EL28BSPT	1222
16EL28UN	1198
16EL28UNJ	1228
16EL28W	1208
16EL2SAGE	1233
16EL2TR	1231
16EL3.00ISO	1188
16EL32UNJ	1228
16EL32W	1208
16EL36UN	1198
16EL36UNJ	1228
16EL3TR	1231
16EL40UN	1198
16EL40UNJ	1228
16EL40W	1208
16EL44UNJ	1228
16EL48UNJ	1228
16EL56W	1208
16EL6RND	1241
16EL6STACME	1224
16EL8ACME	1226
16EL8NPT	1218
16EL8NPTF	1220
16EL8RND	1241
16EL8STACME	1224
16EL8UN	1198
16EL8UNJ	1228
16EL8W	1208
16EL9UNJ	1228
16EL9W	1208
16ELA55	1184
16ELA60	1186
16ELAG55	1184
16ELAG60	1186
16ELG55	1184
16ELG60	1186
16ERO.35ISO	1189
16ERO.40ISO	1189
16ERO.45ISO	1189
16ERO.50ISO	1189
16ERO.60ISO	1189
16ERO.70ISO	1189
16ERO.75ISO	1189
16ERO.80ISO	1189
16ER1.00ISO	1189
16ER1.25ISO	1189
16ER1.50ISO	1189
16ER1.5TR	1231
16ER1.75ISO	1189
16ER10ABUT	1235
16ER10ACME	1226
16ER10APIRD	1237
16ER10RND	1241
16ER10STACME	1224
16ER10UN	1199
16ER10UNJ	1229
16ER10W	1209
16ER11.5NPT	1218
16ER11.5NPTF	1220
16ER11.5UN	1199
16ER11BSPT	1222
16ER11UN	1199
16ER11UNJ	1229
16ER11W	1209
16ER12ABUT	1235

Designation	Page
16ER12ACME	1226
16ER12STACME	1224
16ER12UN	1199
16ER12UNJ	1229
16ER12W	1209
16ER13UN	1199
16ER13UNJ	1229
16ER14ACME	1226
16ER14BSPT	1222
16ER14NPT	1218
16ER14NPTF	1220
16ER14STACME	1224
16ER14UN	1199
16ER14UNJ	1229
16ER14W	1209
16ER16ABUT	1235
16ER16ACME	1226
16ER16STACME	1224
16ER16UN	1199
16ER16UNJ	1229
16ER16W	1209
16ER18NPT	1218
16ER18NPTF	1220
16ER18UN	1199
16ER18UNJ	1229
16ER18W	1209
16ER19BSPT	1222
16ER19W	1209
16ER2.00ISO	1189
16ER2.50ISO	1189
16ER20ABUT	1235
16ER20UN	1199
16ER20UNJ	1229
16ER20W	1209
16ER22W	1209
16ER24UN	1199
16ER24UNJ	1229
16ER24W	1209
16ER26W	1209
16ER27NPT	1218
16ER27NPTF	1220
16ER28BSPT	1222
16ER28UN	1199
16ER28UNJ	1229
16ER28W	1209
16ER2SAGE	1233
16ER2TR	1231
16ER3.00ISO	1189
16ER32UN	1199
16ER32UNJ	1229
16ER32W	1209
16ER36UN	1199
16ER36UNJ	1229
16ER3TR	1231
16ER40UN	1199
16ER40UNJ	1229
16ER44UNJ	1229
16ER48UN	1199
16ER48UNJ	1229
16ER56UN	1199
16ER56W	1209
16ER6RND	1241
16ER6STACME	1224
16ER8ACME	1226
16ER8APIRD	1237
16ER8NPT	1218
16ER8NPTF	1220
16ER8RND	1241
16ER8STACME	1224
16ER8UN	1199
16ER8UNJ	1229
16ER8W	1209
16ER9UN	1199
16ER9UNJ	1229
16ER9W	1209
16ERA55	1184
16ERA60	1186

Designation	Page
16ERAG55	1184
16ERAG60	1186
16ERG55	1184
16ERG60	1186
16ERM1.00ISO	1190
16ERM1.25ISO	1190
16ERM1.50ISO	1190
16ERM1.75ISO	1190
16ERM11.5NPT	1218
16ERM11W	1210
16ERM12UN	1200
16ERM13UN	1200
16ERM14NPT	1218
16ERM14UN	1200
16ERM14W	1210
16ERM16UN	1200
16ERM16W	1210
16ERM18NPT	1218
16ERM18UN	1200
16ERM19W	1210
16ERM2.00ISO	1190
16ERM2.50ISO	1190
16ERM20UN	1200
16ERM24UN	1200
16ERM3.00ISO	1190
16ERM6RND	1241
16ERM8NPT	1218
16ERM8UN	1200
16ERMA60	1186
16ERMAG55	1184
16ERMAG60	1186
16ERMG55	1184
16ERMG60	1186
16ILO.35ISO	1192
16ILO.40ISO	1192
16ILO.45ISO	1192
16ILO.50ISO	1192
16ILO.60ISO	1192
16ILO.70ISO	1192
16ILO.75ISO	1192
16ILO.80ISO	1192
16IL1.00ISO	1192
16IL1.25ISO	1192
16IL1.50ISO	1192
16IL1.75ISO	1192
16IL10ABUT	1235
16IL10ACME	1227
16IL10RND	1241
16IL10STACME	1225
16IL10UN	1202
16IL10W	1212
16IL11.5NPT	1219
16IL11.5NPTF	1221
16IL11.5UN	1202
16IL11BSPT	1223
16IL11UN	1202
16IL11W	1212
16IL12ABUT	1235
16IL12ACME	1227
16IL12STACME	1225
16IL12UN	1202
16IL12W	1212
16IL13UN	1202
16IL14ACME	1227
16IL14BSPT	1223
16IL14NPT	1219
16IL14NPTF	1221
16IL14STACME	1225
16IL14UN	1202
16IL14W	1212
16IL16ABUT	1235
16IL16ACME	1227
16IL16STACME	1225
16IL16UN	1202
16IL16W	1212
16IL18NPT	1219
16IL18NPTF	1221

INDEX

Designation	Page	Designation	Page	Designation	Page
16IL18UN	1202	16IR16ABUT	1235	16IRM20UN	1206
16IL18W	1212	16IR16ACME	1227	16IRM3.00ISO	1196
16IL19BSPT	1223	16IR16STACME	1225	16IRM6RND	1241
16IL19W	1212	16IR16UN	1204	16IRM8NPT	1219
16IL2.00ISO	1192	16IR16W	1214	16IRM8UN	1206
16IL2.50ISO	1192	16IR18NPT	1219	16IRMA60	1187
16IL20ABUT	1235	16IR18NPTF	1221	16IRMAG55	1185
16IL20UN	1202	16IR18UN	1204	16IRMAG60	1187
16IL20W	1212	16IR18UNJ	1230	16IRMG55	1185
16IL22W	1212	16IR18W	1214	16IRMG60	1187
16IL24UN	1202	16IR19W	1214	18T-10018TRRN02	414
16IL24W	1212	16IR20ABUT	1235	18T-10025TRRN02	414
16IL26W	1212	16IR20UN	1204	18T-10037TRRN02	414
16IL27NPT	1219	16IR20UNJ	1230	18T14019TQRS000	429
16IL27NPTF	1221	16IR20W	1214	18T14028TQRS000	429
16IL28BSPT	1223	16IR22W	1214	18T14033TQRS000	429
16IL28UN	1202	16IR24UN	1204	18T14043TQRS000	429
16IL28W	1212	16IR24UNJ	1230	18T16323T6RS000	429
16IL2SAGE	1233	16IR24W	1214	18T16333T6RS000	429
16IL3.00ISO	1192	16IR26W	1214	18T16343T6RS000	429
16IL32UN	1202	16IR27NPT	1219	18T19439T8RS000	429
16IL32W	1212	16IR27NPTF	1221	18T19444T8RS000	429
16IL36UN	1203	16IR28UN	1204	18T19451T8RS000	429
16IL3TR	1231	16IR28UNJ	1230	18T19467T8RS000	429
16IL40UN	1203	16IR28W	1214	18T19844T8RS000	429
16IL40W	1212	16IR2SAGE	1233	18T19854T8RS000	429
16IL44UN	1203	16IR2TR	1231	18T19863T8RS000	429
16IL56UN	1203	16IR32UN	1204	18T23453T8RS000	429
16IL56W	1212	16IR32UNJ	1230	18T23463T8RS000	429
16IL6RND	1241	16IR32W	1214	18T23483T8RS000	429
16IL6STACME	1225	16IR36UN	1205	18T23499T8RS000	429
16IL8ACME	1227	16IR36UNJ	1230	18T25826T8RS000	429
16IL8NPT	1219	16IR3TR	1231	18T25840T8RS000	429
16IL8NPTF	1221	16IR40UN	1205	18T25850T8RS000	429
16IL8RND	1241	16IR40UNJ	1230	18T25866T8RS000	429
16IL8STACME	1225	16IR40W	1214	18T25883T8RS000	429
16IL8UN	1202	16IR44UN	1205	18T25899T8RS000	429
16IL8W	1212	16IR44UNJ	1230	18T28610T8RS000	429
16IL9UN	1202	16IR48UNJ	1230	18T28628T8RS000	429
16IL9W	1212	16IR56UN	1205	18T28636T8RS000	429
16ILA55	1185	16IR56W	1214	18T28656T8RS000	429
16ILA60	1187	16IR6RND	1241	18T-5006TQRN00	414
16ILAG55	1185	16IR6STACME	1225	18T-5012TQRN00	414
16ILAG60	1187	16IR8ACME	1227	18T-6205T6RNO2	414
16ILG55	1185	16IR8APIRD	1237	18T-6206T6RNO1	414
16ILG60	1187	16IR8NPT	1219	18T-6206T6RNO2	414
16IR10ABUT	1235	16IR8NPTF	1221	18T-6208T6RNO1	414
16IR10ACME	1227	16IR8RND	1241	18T-6208T6RNO2	414
16IR10APIRD	1237	16IR8STACME	1225	18T-6210T6RNO1	414
16IR10RND	1241	16IR8UN	1204	18T-6212T6RNO	415
16IR10STACME	1225	16IR8UNJ	1230	18T-6212T6RNO1	414
16IR10UN	1204	16IR8W	1214	18T-6216T6RNO1	414
16IR10UNJ	1230	16IR9UN	1204	18T-6216T6RNO6	413
16IR10W	1214	16IR9UNJ	1230	18T-7516T8RNO1	414
16IR11.5NPT	1219	16IR9W	1214	18T-7519T8RNO1	414
16IR11.5NPTF	1221	16IRA55	1185	18T-7525T8RNO1	414
16IR11.5UN	1204	16IRA60	1187	18T-8718T8RNO1	414
16IR11BSPT	1223	16IRAG55	1185	18T-8725T8RNO1	414
16IR11UN	1204	16IRAG60	1187	18T-8731T8RNO1	414
16IR11UNJ	1230	16IRG55	1185	1BW7T-05007T8R01	295
16IR11W	1214	16IRG60	1187	1BW7T-05010X5R01	294
16IR12ABUT	1235	16IRM1.00ISO	1196	1BW7T-0501778R01	292
16IR12ACME	1227	16IRM1.25ISO	1196	1BW7V-07010TSR01	295
16IR12STACME	1225	16IRM1.50ISO	1196	1BW7V-0701584R01	292
16IR12UN	1204	16IRM1.75ISO	1196	1BW7V-07015X6R01	294
16IR12UNJ	1230	16IRM11.5NPT	1219	1BW7V-0704084R01	292
16IR12W	1214	16IRM11W	1216	1BW7W-1001580R01	292
16IR13UN	1204	16IRM12UN	1206	1BW7W-10015X7R01	294
16IR13UNJ	1230	16IRM14NPT	1219	1BW7W-10037E1R01	292
16IR14ACME	1227	16IRM14UN	1206	1BW7X-1202781R01	292
16IR14BSPT	1223	16IRM14W	1216	1BW7X-1205081R01	292
16IR14NPT	1219	16IRM16UN	1206	1BW7X-1205781R01	292
16IR14NPTF	1221	16IRM16W	1216	1BW7Y-2003076R01	296
16IR14STACME	1225	16IRM18UN	1206	1BW8T-0504584R01	292
16IR14UN	1204	16IRM19W	1216	1BW8V-0705780R01	292
16IR14UNJ	1230	16IRM2.00ISO	1196	1DB1H-1203181R01	250
16IR14W	1214	16IRM2.50ISO	1196	1DB1H-1501581R01	250

Designation	Page
1DG1H-12017X8R01	270
1DG1H-1202781R01	269
1DG1H-12057S9R01	269
1DG1H-15017X8R01	270
1DG1H-1503386R01	269
1DG1H-15073S5R01	269
1DP1G-12015X8R01	275
1DP1G-1202781R01	274
1DP1G-12057S9R	274
1DP1G-15017X8R01	275
1DP1G-1503386R01	274
1DP1G-15073S5R01	274
1SJ1F-10015X7R01	50
1SJ1F-1001780R01	48
1SJ1F-1003780R01	48
1SJ1F-12015X8R01	50
1SJ1F-12015X8R02	50
1SJ1F-1201781R01	48
1SJ1F-15015X8R01	50
1SJ1F-15015X8R02	50
1SJ1F-1501781R01	48
1SJ1F-1501781R02	48
1SJ1Y-07010TSR01	47
1SJ1Y-0701280R01	44
1SJ1Y-0701280R02	44
1SJ1Y-0701284R01	44
1SJ1Y-07015X6R01	46
1SJ1Y-07015X6R02	46
1SJ1Y-0702280R01	44
1SJ1Y-0703280R01	44
1SJ1Y-10012TUR01	47
1SJ1Y-10015X7R01	46
1SJ1Y-10015X7R02	46
1SJ1Y-1001780R01	44
1SJ1Y-1001780R02	44
1SJ1Y-1001784R01	44
1SJ1Y-1003280R01	44
1SJ1Y-1201781R01	44
1SJ1Y-1201781R02	44
1SJ1Y-1201784R01	44
1SJ1Y-12017X8R01	46
1SJ1Y-12017X8R02	46
1SJ1Y-1203281R01	44
1SJ1Y-1501781R01	44
1SJ1Y-1501781R02	44
1SJ1Y-15017X8R01	46
1SJ1Y-15017X8R02	46
1SJ1Y-1502281R01	44
1TG1F-06010X5R01	267
1TG1F-06015S6R01	266
1TG1F-06015ULR01	266
1TG1F-07011X6R01	267
1TG1F-07017UMR01	266
1TG1F-07017UMR02	266
1TG1F-07022S7R01	266
1TG1F-07032S7R01	266
1TG1F-08019UNR01	266
1TG1F-10013X7R01	267
1TG1F-10022S1R01	266
1TG1F-10022T5R01	266
1TG1F-10022T5R02	266
1TG1F-10032S1R01	266
1TG1F-12015X8R01	267
1TG1F-1203281R01	266
1TG1F-12050E2R01	266
1TG1F-15015E2R01	266
1TJ1N-12015X8R01	43
1TJ1N-1202281R01	42
1TJ1N-1204281R01	42
1TJ1N-1206281R01	42
1TJ1N-15015X8R01	43
1TJ1N-1502281R01	42
1TJ1N-1504281R01	42
1TJ1N-2002281R01	42
22EL3.50ISO	1188
22EL3SAGE	1233
22EL4.00ISO	1188

Designation	Page
22EL4.50ISO	1188
22EL4RND	1241
22EL4SAGE	1233
22EL4TR	1231
22EL5.00ISO	1188
22EL5ACME	1226
22EL5TR	1231
22EL5UN	1198
22EL5UNJ	1228
22EL5W	1208
22EL6ABUT	1235
22EL6ACME	1226
22EL6RND	1241
22EL6UN	1198
22EL6UNJ	1228
22EL6W	1208
22EL7UN	1198
22EL7UNJ	1228
22EL7W	1208
22EL8ABUT	1235
22ELN55	1184
22ELN60	1186
22ELQ60	1186
22ER3.50ISO	1189
22ER3SAGE	1233
22ER4.00ISO	1189
22ER4.50ISO	1189
22ER4RND	1241
22ER4SAGE	1233
22ER4TR	1231
22ER5.00ISO	1189
22ER5ACME	1226
22ER5API403	1238
22ER5BUT0.75	1239
22ER5BUT1.0	1239
22ER5EL1.25	1240
22ER5STACME	1224
22ER5TR	1231
22ER5UNJ	1229
22ER5W	1209
22ER6ABUT	1235
22ER6ACME	1226
22ER6EL1.5	1240
22ER6RND	1241
22ER6UNJ	1229
22ER6W	1209
22ER7UNJ	1229
22ER7W	1209
22ER8ABUT	1235
22ERMN60	1186
22ERN55	1184
22ERN60	1186
22IL3.50ISO	1192
22IL3SAGE	1233
22IL4RND	1241
22IL4SAGE	1233
22IL5ACME	1227
22IL5STACME	1225
22IL5UN	1203
22IL5W	1213
22IL6ABUT	1235
22IL6ACME	1227
22IL6RND	1241
22IL6UN	1203
22IL6W	1213
22IL7UN	1203
22IL7W	1213
22IL8ABUT	1235
22ILN55	1185
22ILN60	1187
22IR3SAGE	1233
22IR4.00ISO	1195
22IR4.50ISO	1195
22IR4.5UNJ	1230
22IR4RND	1241
22IR4SAGE	1233
22IR4TR	1231

Designation	Page
22IR4UNJ	1230
22IR5.00ISO	1195
22IR5ACME	1227
22IR5API403	1238
22IR5BUT0.75	1239
22IR5BUT1.0	1239
22IR5EL1.25	1240
22IR5STACME	1225
22IR5TR	1231
22IR5UN	1205
22IR5UNJ	1230
22IR5W	1215
22IR6ABUT	1235
22IR6ACME	1227
22IR6EL1.5	1240
22IR6RND	1241
22IR6UN	1205
22IR6W	1215
22IR7UN	1205
22IR7UNJ	1230
22IR7W	1215
22IR8ABUT	1235
22IRMN60	1187
22IRN55	1185
22IRN60	1187
22J3D-0601179R01	70
22J3D-0701484R01	70
22J3D-1001880R01	70
22J3E-1502381R01	78
22J3E-20022D1R01	82
22J3E-2002381R01	78
22J3E-2005548R01	80
22J3E-25030D3R01	82
22J3E-30033D4R01	82
22J3E-40044D5R01	82
22J3G-1502581R01	76
22J3P-1001780R01	71
22J3P-1202480R01	71
22J3P-1502881R01	71
22J3X-1001680R01	72
22J3X-1002080R01	72
22J3X-1002780R01	72
22J3X-1201680R01	72
22J3X-1202480R01	72
22J3X-1203380R01	72
22J3X-1502381R01	72
22J3X-1502881R01	72
22J3X-1503429R01	72
22J3X-15044B4R01	72
22J3X-20022D1R01	74
22J3X-20025D1R01	74
22J3X-2002781R01	72
22J3X-2005548R01	72
22J3X-25030D3R01	74
22N3X-13020D3R01	225
22UEIRL4.5W	1217
22UEIRL4W	1217
22UEIRLU55	1185
22UEIRLU60	1187
22UEL4ABUT	1236
22UEL5SAGE	1234
22UEL6SAGE	1234
22UER4ABUT	1236
22UER5SAGE	1234
22UER6SAGE	1234
22UERL4.5UN	1201
22UERL4UN	1201
22UERL5.50ISO	1191
22UERL6.00ISO	1191
22UERL6TR	1232
22UERL7TR	1232
22UIL4ABUT	1236
22UIL5SAGE	1234
22UIL6SAGE	1234
22UIR4ABUT	1236
22UIR5SAGE	1234
22UIR6SAGE	1234

INDEX

Designation	Page
22UIRL4.5UN	1207
22UIRL4UN	1207
22UIRL5.50ISO	1197
22UIRL6.00ISO	1197
22UIRL6TR	1232
22UIRL7TR	1232
22Y3Q-0902280R01	578
22Y3R-1302781R01	579
22Y3S-1802781R01	580
22Y3T-25020D1R01	581
23J2G-2005052A02	96
23J2G-2006148A02	96
23J2G-20EC168R02	96
23J2G-20EC172R02	96
23J2G-20HL452R01	96
23J2G-20HL548R01	96
23J6G-1502881R00	98
23J6G-2003081R00	98
23J6G-2005052R00	98
23J6G-2006145R00	98
23J6G-2006148R00	98
23J6G-2008048R00	98
25J3F-1202281R01	92
25J3G-1502681R01	92
25J3G-20020D1R01	93
25J3G-20022D1R01	93
25J3H-2002781R01	100
25J3H-20042Z4R01	100
25J3H-2006048R01	100
25J3H-20060B5R01	100
25J3H-20062H1R01	100
25J3H-25040D3R01	102
25J3H-30050D4R01	102
25J3H-30050D4R11	102
25J3H-30062H1R01	100
25J3H-40047D5R01	102
25J3J-25035D3R01	93
25J3J-2506048A01	94
25J3J-2507548A01	94
25J3J-25EC172R01	94
25J3J-25HL448R01	94
25J3J-25HL648R01	94
25J3J-30040D4R01	93
25J3J-40050D5R01	93
27EL3STACME	1224
27EL4.5UN	1198
27EL4.5UNJ	1228
27EL4.5W	1208
27EL4ACME	1226
27EL4RND	1241
27EL4STACME	1224
27EL4UN	1198
27EL4UNJ	1228
27EL5.50ISO	1188
27EL6.00ISO	1188
27EL6TR	1231
27EL7TR	1231
27ELQ55	1184
27ER3STACME	1224
27ER4.5UNJ	1229
27ER4.5W	1209
27ER4ACME	1226
27ER4API382	1238
27ER4API383	1238
27ER4API502	1238
27ER4API503	1238
27ER4RND	1241
27ER4STACME	1224
27ER4UNJ	1229
27ER4W	1209
27ER5.50ISO	1189
27ER6.00ISO	1189
27ER6TR	1231
27ER7TR	1231
27ERQ55	1184
27ERQ60	1186
27IL3STACME	1225

Designation	Page
27IL4.5UN	1203
27IL4.5W	1213
27IL4ACME	1227
27IL4RND	1241
27IL4STACME	1225
27IL4UN	1203
27IL4W	1213
27IL6TR	1231
27ILQ55	1185
27ILO60	1187
27IR3STACME	1225
27IR4.5UN	1205
27IR4.5W	1215
27IR4ACME	1227
27IR4API382	1238
27IR4API383	1238
27IR4API502	1238
27IR4API503	1238
27IR4RND	1241
27IR4STACME	1225
27IR4UN	1205
27IR4W	1215
27IR5.50ISO	1195
27IR6.00ISO	1195
27IR6TR	1231
27IRQ55	1185
27IRQ60	1187
27UEIRL2.75W	1217
27UEIRL3.00W	1217
27UEIRL3.25W	1217
27UEIRL3.50W	1217
27UEIRLU55	1185
27UEIRLU60	1187
27UEL3ABUT	1236
27UER3ABUT	1236
27UERL3ACME	1226
27UERL3UN	1201
27UERL8.00ISO	1191
27UERL8TR	1232
27UERL9TR	1232
27UIL3ABUT	1236
27UIR3ABUT	1236
27UIRL3ACME	1227
27UIRL3UN	1207
27UIRL8.00ISO	1197
27UIRL8TR	1232
27UIRL9TR	1232
27UIRL9TR	1232
2BW3Y-20040E4R01	292
2BW3Y-20070E4R01	292
2BW3Z-1504581R01	292
2BW3Z-1506086R01	292
2E-831-01	129
2H-422-01	127
2J1D-15R01	110
2J1D-20R10	110
2J1E-20R01	116
2J1E-20R02	116
2J1E-25R01	116
2J1E-25R02	116
2J1E-30R01	116
2J1E-30R02	116
2J1E-30R03	116
2J1E-40R01	116
2J1E-40R02	116
2J1E-50R01	116
2J1E-50R02	116
2J1E-60R01	116
2J1E-60R02	116
2J1E-80R01	116
2J1E-80R02	116
2J1G-20R01	114
2J1G-20R02	114
2J1G-25R01	114
2J1G-30R01	114
2J1G-30R02	114
2J1G-40R01	114
2J1G-40R02	114

Designation	Page
2J1G-50R01	114
2J1G-60R01	114
2J1G-60R02	114
2J1G-80R01	114
2J1P-15R01	111
2J1P-20R01	111
2J1P-30R01	111
2J1X-15R01	112
2J1X-20R01	112
2J1X-20R02	112
2J1X-25R01	112
2J1X-30R01	112
2J1X-40R01	112
2J4E-20R02	116
2J4E-30R02	116
2J4E-40R02	116
2L1E-25R01	118
2L1E-40R01	118
2L1X-30R01	112
2M0813-01	169
2SJ1H-30040D4R01	88
2SJ1L-40047D5R01	88
2SJ1L-40047D5R02	88
2SJ1N-40040D5L01	89
2SJ1N-40040D5R01	89
2SJ3F-1201781R01	85
2SJ3F-1502081R01	85
2SJ3F-2002581R01	85
2SJ3F-25030D3R01	86
2SJ3F-30035D4R01	86
2SJ3J-25030D3R01	87
2SJ3J-30035D4R01	87
2SJ3J-40045D5R01	87
2SJ3Y-1001780R01	84
2SJ3Y-1201781R01	84
2SJ3Y-1502281R01	84
2TJ3N-2003081R01	90
2TJ3N-2005548R01	90
2TJ3N-25036D3R01	91
2TJ3N-30040D4R01	91
2TJ3N-40040D5R01	91
36C-102051RM02	IN2005 432
36C-2505R6RM00	IN2005 432
36C-3106R7RM01	IN2005 432
36C-5010S4RM01	IN2005 432
36C-6212S6RM02	IN2005 432
36C-7515S7RM02	IN2005 432
38L5G-02015D1R25	210
38L5G-02018D1R25	210
38L5G-03015D1R01	210
38L5G-03018AF-01	208
38L5G-03018D1R01	210
38L5G-04015D3R01	210
38L5G-04018AF-01	208
38L5G-04018D3R01	210
38L5G-05015D3R01	210
38L5G-05018AG-01	208
38L5G-05018D3R01	210
38L5G-06015AG-01	208
38L5G-06018AG-01	208
38L5H-02025D1R25	210
38L5H-03025D1R01	210
38L5H-04025AF-01	208
38L5H-04025D3R01	210
38L5H-04031D3R01	210
38L5H-05025AG-01	208
38L5H-05025D3R01	210
38L5H-05031AG-01	208
38L5H-05031D3R01	210
38L5H-06025AG-01	208
38L5H-06031AG-01	208
38L5H-08025AH-01	208
38L5H-08031AH-01	208
3SJ6E-0406257R01	216
3SJ6E-04062AG-01	214
3SJ6E-0506257R01	216
3SJ6E-05062AH-01	214

Designation	Page
3SJ6E-0606258R01	216
3SJ6E-06062AH-01	214
3SJ6E-0806258R01	216
3SJ6E-08062AK-01	214
3SJ6E-1006261R01	216
3SJ6E-10062AK-01	214
3SJ6H-0407557R01	216
3SJ6H-04075AG-01	214
3SJ6H-0507557R01	216
3SJ6H-05075AH-01	214
3SJ6H-0607558R01	216
3SJ6H-06075AH-01	214
3SJ6H-0807558R01	216
3SJ6H-08075AK-01	214
3SJ6H-1007561R01	216
3SJ6H-10075AK-01	214
3SJ6L-0410057R01	216
3SJ6L-04100AG-01	214
3SJ6L-0510057R01	216
3SJ6L-05100AH-01	214
3SJ6L-0610058R01	216
3SJ6L-06100AH-01	214
3SJ6L-0810058R01	216
3SJ6L-08100AK-	214
3SJ6L-1010061R01	216
3SJ6L-10100AK-01	214
3VL5V-04037AG-01	212
3VL5V-04037D3R01	213
3VL5V-04050AG-01	212
3VL5V-04050D3R01	213
3VL5V-05037AH-01	212
3VL5V-05037D3R01	213
3VL5V-05050AH-01	212
3VL5V-05050D3R01	213
3VL5V-0603758R02	213
3VL5V-06037AH-02	212
3VL5V-0605058R02	213
3VL5V-06050AH-02	212
3VL5V-0803758R01	213
3VL5V-08037AK-01	212
3VL5V-0805058R01	213
3VL5V-08050AK-01	212
45A10001T6RA20	402
45A12001T8RA25	402
45A16001T8RA30	402
45A-2500R6RA03 IN2005	445
45A-3100R7RA05 IN2005	445
45A-3700R8RA06 IN2005	445
45A-3703T6RA06	402
45A-5000S4RA07 IN2005	445
45A-5004T8RA08	402
45A-7506TSRA12	402
45B-1201R4RB15 IN2005	446
45B-1802R5RB20 IN2005	446
45B-2503R6RB25 IN2005	446
45B-3103R7RB25 IN2005	446
45B-3120TQRB03	407
45B-3120TQRB03-P	409
45B-3131TQRA04	405
45B-3131TQRW04	405
45B-3704R8RB25 IN2005	446
45B-3727T6RB05	407
45B-3727T6RB05-P	409
45B-3738T6RA04	405
45B-3738TRW04	405
45B-4305R9RB27 IN2005	446
45B-5005S4RB30 IN2005	446
45B-5037T8RB06	407
45B-5037T8RB06-P	409
45B-5050T8RA06	405
45B-5050T8RW06	405
45B-6206S6RB35 IN2005	446
45B-6235TRRB08	407
45B-6247TRRB08-P	409
45B-6263TRRA07	405
45B-6263TRRW07	405
45B-7550TSRB10	407

Designation	Page
45B-7550TSRB10-P	409
45C-1205R4RB00 IN2005	435
45C-1803R5RB00 IN2005	435
45C-2505R6RB00 IN2005	435
45C-2507R6RB00 IN2005	435
45C-3108R7RB00 IN2005	435
45C-3707R7RB00 IN2005	435
45C-3707R8RB00 IN2005	435
45C-3710R8RB00 IN2005	435
45C-4310R9RB00 IN2005	435
45C-5010T8RB00 IN2005	435
45C-5010S4RB00 IN2005	435
45C-6210S6RB00 IN2005	435
45C-7584S7RB00 IN2005	435
45D-2550S3RP05 IN2005	443
45D-3162R7RP06 IN2005	443
45D-3727T6RD02-P	399
45D-3738T6RA01	400
45D-3775R8RP07 IN2005	443
45D-3793R8RP70 IN2005	443
45D-5010S4RP10 IN2005	443
45D-5012S4RP10 IN2005	443
45D-5045T8RA01	400
45D-6212S6RP13 IN2005	443
45D-6215S6RP13 IN2005	443
45D-6263TRRA01	400
45D-7515S7RP15 IN2005	443
45D-7518S7RP15 IN2005	443
45J-1015S1RD45 IN05S	434
45J-2505R6RD25 IN05S	434
45J-3106R7RD25 IN05S	434
45J-3707R8RD30 IN05S	434
45J-3727T6RD05-P	399
45J-5010S4RD30 IN05S	434
45J-5037T8RD06-P	399
45J-6210S6RD35 IN05S	434
45J-7512S7RD40 IN05S	434
45M10009T6RA30	410
45N08007TQRA45	410
45N10009T6RA45	410
45N-10009T6RA45	410
45N10009T6RA72	410
45N16015TRRA45	410
45P10009T6RA60	410
45R10009T6RA16	412
45R10009T6RA25	412
45R12012T8RA30	412
45R12012T8RA40	412
45R16015TRRA50	412
45U-0600R0RB01 IN2005	444
45U-0900R1RB03 IN2005	444
45U-1200R4RB03 IN2005	444
45U-2501R6RB06 IN2005	444
45U-2501R6RB061 IN2005	444
45U-3701R8RB06 IN2005	444
45U-3701R8RB061 IN2005	444
45U-5002S4RB12 IN2005	444
45U-5002S4RB121 IN2005	444
45V-3738T6RA03	401
45V-5045T8RA03	401
45V-6260TRRA03	401
45X-3727TQRA03	406
45X-5037T6RA04	406
45X-6248T8RA06	406
45X-7560TRRA07	406
45Z03208TQRA15	417
45Z06517TRRA28	417
45Z-1851T8RA09	417
45Z-2152T8RA09	417
46B-1201R4RB15 IN2005	446
46B-1802R5RB20 IN2005	446
46B-2503R6RB25 IN2005	446
46B-3103R7RB25 IN2005	446
46B-3704R8RB25 IN2005	446
46B-5005S4RB30 IN2005	446
46B-6206S6RB35 IN2005	446
46D-1015S1RQ02 IN05S	441

Designation	Page
46D-1015S1RQ020 IN05S	441
46D-1015S1RQ03 IN05S	441
46D-1015S1RQ030 IN05S	441
46D-1015S1RQ06 IN05S	441
46D-1015S1RQ060 IN05S	441
46D-1015S1RQ09 IN05S	441
46D-1015S1RQ090 IN05S	441
46D-1015S1RQ12 IN05S	441
46D-1015S1RQ120 IN05S	441
46D-1202R4RC00 IN2005	438
46D-1803R5RC00 IN2005	438
46D-2505R6RC02 IN2005	438
46D-2535R6RQ02 IN05S	440
46D-2535R6RQ020 IN05S	440
46D-2535R6RQ03 IN05S	440
46D-2535R6RQ030 IN05S	440
46D-3106R7RC02 IN2005	438
46D-3120TQRD02-P	399
46D-3120TQRD03	394
46D-3150R7RQ02 IN05S	440
46D-3150R7RQ020 IN05S	440
46D-3150R7RQ03 IN05S	440
46D-3150R7RQ030 IN05S	440
46D-3707R8RC02 IN2005	438
46D-3710S4RC30 IN2005	438
46D-3727T6RD01	394
46D-3727T6RD03	394
46D-3727T6RD03-P	399
46D-3727T6RD06	394
46D-3727T6RD06-P	399
46D-3760R8RQ02 IN05S	440
46D-3760R8RQ020 IN05S	440
46D-3760R8RQ03 IN05S	440
46D-3760R8RQ030 IN05S	440
46D-3760R8RQ06 IN05S	440
46D-3760R8RQ060 IN05S	440
46D-5010T8RC30 IN2005	438
46D-5037T8RD01	394
46D-5037T8RD02-P	399
46D-5037T8RD03	394
46D-5037T8RD03-P	399
46D-5037T8RD06	394
46D-5037T8RD06-P	399
46D-5037T8RD09-P	399
46D-5037T8RD12-P	399
46D-5075S4RQ02 IN05S	440
46D-5075S4RQ020 IN05S	440
46D-5075S4RQ03 IN05S	440
46D-5075S4RQ030 IN05S	440
46D-5075S4RQ06 IN05S	440
46D-5075S4RQ060 IN05S	440
46D-6210R4RC03 IN2005	438
46D-6210S6RQ02 IN05S	440
46D-6210S6RQ020 IN05S	440
46D-6210S6RQ03 IN05S	440
46D-6210S6RQ030 IN05S	440
46D-6210S6RQ06 IN05S	440
46D-6210S6RQ060 IN05S	440
46D-6210S6RQ090 IN05S	440
46D-6239TRRD03-P	399
46D-6239TRRD06-P	399
46D-6239TRRD09-P	399
46D-6239TRRD12-P	399
46D-7512S7RC03 IN2005	438
46D-7512S7RQ02 IN05S	440
46D-7512S7RQ020 IN05S	440
46D-7512S7RQ03 IN05S	440
46D-7512S7RQ030 IN05S	440
46D-7512S7RQ06 IN05S	440
46D-7512S7RQ060 IN05S	440
46D-7512S7RQ09 IN05S	440
46D-7512S7RQ090 IN05S	440
46D-7550TSRD02-P	399
46D-7550TSRD06-P	399
46D-7550TSRD09-P	399
46D-7550TSRD12-P	399

INDEX

Designation	Page
46DE1015S1RC03	438
46J0751284RC40	438
46J-1015S1RD45	434
46J-1202R4RC15	438
46J-1803R5RC20	438
46J-2505R6RC25	438
46J-2505R6RD25	434
46J-3106R7RC25	438
46J-3106R7RD25	434
46J-3120TQRD04	394
46J-370777RC25	438
46J-3707R8RC25	438
46J-3707R8RD30	434
46J-3727T6RD05	394
46J-5010S4RC03	438
46J-5010S4RD35	434
46J-5037T8RD06	394
46J-621079RC35	438
46J-6210R4RC35	438
46J-6210S6RD35	434
46J-6239TRRD08-P	399
46J-7512S7RC40	438
46J-7512S7RD40	434
46JE1015S1RC15	438
46JE1015S1RC40	438
46Y040ISR6LM050	555
46Y040ISR6RM050	553
46Y045ISR6LM050	555
46Y045ISR6LM060	555
46Y045ISR6LM080	555
46Y045ISR6RM050	553
46Y045ISR6RM060	553
46Y045ISR6RM080	553
46Y050ISR6LM070	555
46Y050ISR6LM090	555
46Y050ISR6RA050	549
46Y050ISR6RA100	549
46Y050ISR6RM070	553
46Y050ISR6RM090	553
46Y060ISR6LM080	555
46Y060ISR6RM080	553
46Y070ISR6LM090	555
46Y070ISR6LM120	555
46Y070ISR6RA070	549
46Y070ISR6RM090	553
46Y070ISR6RM120	553
46Y075ISR6RA100	549
46Y080ISR6LM120	555
46Y080ISR6LM160	555
46Y080ISR6RA090	549
46Y080ISR6RM120	553
46Y080ISR6RM160	553
46Y-08UNS6RA430	548
46Y-09UNS6RA380	548
46Y100ISR6LM140	555
46Y100ISR6LM200	555
46Y100ISR6RA100	549
46Y100ISR6RA130	549
46Y100ISR6RA140	549
46Y100ISR6RM140	553
46Y100ISR6RM200	553
46Y-10UNS4RA350	548
46Y-11UNR8RA270	548
46Y-11UNS4RM350	552
46Y125ISR6LM180	555
46Y125ISR6LM240	555
46Y125ISR6RA150	549
46Y125ISR6RA190	549
46Y125ISR6RM180	553
46Y125ISR6RM240	553
46Y-12UNR8RA250	548
46Y-12UNS4RM310	552
46Y-13UNR7RA230	548
46Y-13UNR8LM270	554
46Y-13UNR8RM270	552
46Y-14UNR7LM250	554
46Y-14UNR7RA200	548

Designation	Page
46Y-14UNR7RM250	552
46Y150ISR7LM230	555
46Y150ISR7RA180	549
46Y150ISR7RA250	549
46Y150ISR7RM230	553
46Y-16UNR6RA180	548
46Y-16UNR7LM220	554
46Y-16UNR7RM220	552
46Y175ISR7RA200	549
46Y175ISR7RA290	549
46Y175ISR8LM260	555
46Y175ISR8RM260	553
46Y-18NFR7RA150	551
46Y-18NFR7RA150	550
46Y-18UNR6LM170	554
46Y-18UNR6LM230	554
46Y-18UNR6RA150	548
46Y-18UNR6RM170	552
46Y-18UNR6RM230	552
46Y200ISR8RA280	549
46Y200ISR8RA390	549
46Y-20UNR6LM140	554
46Y-20UNR6LM190	554
46Y-20UNR6RA120	548
46Y-20UNR6RM140	552
46Y-20UNR6RM190	552
46Y-20UNR7RA200	548
46Y-24UNR6LM110	554
46Y-24UNR6RA150	548
46Y-24UNR6RM110	552
46Y-24UNR7LM170	554
46Y-24UNR7LM240	554
46Y-24UNR7RA200	548
46Y-24UNR7RM160	552
46Y-24UNR7RM170	552
46Y-27NFR6RA100	551
46Y-27NFR7RB110	551
46Y-27NTR6RA100	550
46Y-27NTR7RB110	550
46Y-28UNR6LM110	554
46Y-28UNR6LM140	554
46Y-28UNR6LM190	554
46Y-28UNR6RA100	548
46Y-28UNR6RA140	548
46Y-28UNR6RM110	552
46Y-28UNR6RM140	552
46Y300ISS6RA410	549
46Y300ISS6RA580	549
46Y-32UNR6LM070	554
46Y-32UNR6LM090	554
46Y-32UNR6LM100	554
46Y-32UNR6LM120	554
46Y-32UNR6LM150	554
46Y-32UNR6RA060	548
46Y-32UNR6RM070	552
46Y-32UNR6RM090	552
46Y-32UNR6RM100	552
46Y-32UNR6RM120	552
46Y-32UNR6RM150	552
46Y-36UNR6LM090	554
46Y-36UNR6RM090	552
46Y-40UNR6LM060	554
46Y-40UNR6LM070	554
46Y-40UNR6LM100	554
46Y-40UNR6RA060	548
46Y-40UNR6RM060	552
46Y-40UNR6RM070	552
46Y-40UNR6RM100	552
46Y-48UNR6LM050	554
46Y-48UNR6RM050	552
46Y-56UNR6LM040	554
46Y-56UNR6RM040	552
46Y-64UNR6LM040	554
46Y-64UNR6RM040	552
46Y-72UNR6LM040	554
46Y-72UNR6RM040	552
46Y-80UNR6RM040	552

Designation	Page
47A08001TQRA16	403
47A10001T6RA20	403
47A16001TRRA32	403
47A20001TSRA40	403
47A-5004T8RA09	403
47B-0308R8RB40	446
47B-1201R4RB15	446
47B-1202R4RB22	446
47B-1205R4RB15	446
47B-1802R5RB20	446
47B-1803R5RB25	446
47B-1806R5RB20	446
47B-2503R6RB25	446
47B-2505R6RB40	446
47B-2507R6RB25	446
47B-2520TQRB03	408
47B-3103R7RB25	446
47B-3107R7RB40	446
47B-3108R7RB25	446
47B-3120TQRB03	407
47B-3704R8RB25	446
47B-3710R8RB30	446
47B-3727T6RB05	407
47B-4305R9RB27	446
47B-4310R9RB30	446
47B-5005S4RB30	446
47B-5010S4RB30	446
47B-5010S4RB45	446
47B-5037T8RB06	407
47B-6206S6RB35	447
47B-6212S6RB35	447
47B-6212S6RB50	447
47B-6247TTRB08	407
47B-7515R8RB50	447
47B-7515S7RB40	447
47B-7562TSTRB10	407
47C-102080RQ02	439
47C-102080RU02	442
47C-1020S1RQ02	439
47C-1020S1RU02	442
47C-1088TURQ02	395
47C-1088TURU02	392
47C-1202R4RQ00	439
47C-1803R5RQ00	439
47C-2505R6RQ01	439
47C-2550R6RU01	442
47C-2563R6RQ08	439
47C-3106R7RQ01	439
47C-3120TQRN01	393
47C-3120TQRQ01	395
47C-3120TQRU01	392
47C-3162R7RU01	442
47C-3178R7RQ01	439
47C-370777RQ01	439
47C-3707R8RQ01	439
47C-3727T6RN01	393
47C-3727T6RQ01	395
47C-3727T6RU01	392
47C-377577RU01	442
47C-3775R8RU01	442
47C-379477RQ01	439
47C-3794R8RQ01	439
47C-501078RQ02	439
47C-501078RU01	442
47C-5010S4RQ02	439
47C-5010S4RU01	442
47C-501278RQ01	439
47C-5012S4RQ01	439
47C-5037T8RN01	393
47C-5037T8RQ02	395
47C-5037T8RU01	392
47C-621279RQ02	439
47C-621279RU02	442
47C-6212S6RQ02	439
47C-6212S6RU02	442
47C-621579RQ02	439
47C-6215S6RQ02	439

Designation	Page
47C-6247TRRN01	393
47C-6247TRRQ02	395
47C-6247TRRU02	392
47C-751584R002 IN2005	439
47C-751584RU02 IN2005	442
47C-751557R002 IN2005	439
47C-751557RU02 IN2005	442
47C-751884R002 IN2005	439
47C-751857R002 IN2005	439
47C-7562TSRQ02	395
47C-7562TSRU02	392
47D-1088TURQ03	395
47D-1088TURQ12	395
47D-1203R4RC00 IN2005	436
47D-1203R4RC001 IN2005	436
47D-1203R5RC00 IN2005	436
47D-2103R3RC00 IN2005	436
47D-2505R6RC00 IN2005	436
47D-2505R6RC02 IN2005	436
47D-2505R6RC03 IN2005	436
47D-2505R6RC06 IN2005	436
47D-3106R7RC00 IN2005	436
47D-3106R7RC02 IN2005	436
47D-3106R7RC03 IN2005	436
47D-3106R7RC06 IN2005	436
47D-3120TQRD01	396
47D-3120TQRD03	396
47D-3120TQRD06	396
47D-3120TQRQ01	395
47D-3707R8RC00 IN2005	436
47D-3707R8RC02 IN2005	436
47D-3727T6RD01	396
47D-3727T6RD03	396
47D-3727T6RD06	396
47D-3727T6RN03	393
47D-3727T6RQ01	395
47D-3727T6RU03	392
47D-4307R9RC27 IN2005	436
47D-501078RC30 IN2005	436
47D-5010S4RC30 IN2005	436
47D-5037T8RD01	396
47D-5037T8RD03	396
47D-5037T8RD06	396
47D-5037T8RN03	393
47D-5037T8RN06	393
47D-5037T8RQ03	395
47D-5037T8RU03	392
47D-621079RC35 IN2005	437
47D-6210S6RC35 IN2005	437
47D-6247TRRB06	396
47D-6247TRRD03	396
47D-6247TRRQ03	395
47D-6247TRRU06	392
47D-7510S7RC40 IN2005	437
47D-751584RC40 IN2005	437
47D-7562TSRB06	396
47D-7562TSRD03	396
47D-7562TSRQ03	395
47D-7562TSRQ12	395
47D-7562TSRU06	392
47J-1203R4RC15 IN2005	436
47J-1203R4RD15 IN2005	433
47J-1503R2RC15 IN2005	436
47J-1803R5RC15 IN2005	436
47J-1805R5RD20 IN2005	433
47J-2103R3RC20 IN2005	436
47J-2505R6RC25 IN2005	436
47J-2506R6RD25 IN2005	433
47J-2520TQRD04	397
47J-3106R7RC25 IN2005	436
47J-3107R7RD25 IN2005	433
47J-3120TQRD04	396
47J-3120TQRQ04	395
47J-370777RC25 IN200	436
47J-3707R8RC03 IN2005	436
47J-3707R8RC06 IN2005	436
47J-3707R8RC25 IN2005	436

Designation	Page
47J-3708R8RD25 IN2005	433
47J-3727T6RD05	396
47J-3727T6RQ05	395
47J-4307R9RC02 IN2005	436
47J-4310R9RD27 IN2005	433
47J-5010S4RC02 IN2005	436
47J-5010S4RC03 IN2005	436
47J-5010S4RC06 IN2005	436
47J-5010S4RC30 IN2005	436
47J-5010S4RD30 IN2005	433
47J-5037T8RD06	396
47J-5037T8RQ06	395
47J-6210S6RC00 IN2005	437
47J-6210S6RC03 IN2005	437
47J-6210S6RC06 IN2005	437
47J-6212S6RD35 IN2005	433
47J-6247TRRD08	396
47J-7515S7RC00 IN2005	437
47J-7515S7RC02 IN2005	437
47J-7515S7RC03 IN2005	437
47J-7515S7RC06 IN2005	437
47J-7515S7RD40 IN2005	433
47N-5006T8RA45	411
47Y075ISTQRA13	416
47Y075ISTQRA13 IN2005	557
47Y-07UNS7RA450 IN2005	548
47Y-08NFS7RA400 IN2005	551
47Y-08NTS7RA410 IN2005	550
47Y-09UNT8RA21	416
47Y-09UNT8RA21 IN2005	556
47Y100ISR7RA180 IN2005	549
47Y100ISTQRA13	416
47Y100ISTQRA13 IN2005	557
47Y-10UNS6RM410 IN2005	552
47Y-10UNT8RA21	416
47Y-10UNT8RA21 IN2005	556
47Y-11NFS6RA280 IN2005	551
47Y-11NFS7RB300 IN2005	551
47Y-11NTS6RA280 IN2005	550
47Y-11NTS7RB300 IN2005	550
47Y-12UNS6RA410 IN2005	548
47Y-12UNT8RA21	416
47Y-12UNT8RA21 IN2005	556
47Y-14NFS4RA210 IN2005	551
47Y-14NFS6RB230 IN2005	551
47Y-14NTS4RA200 IN2005	550
47Y-14NTS6RB230 IN2005	550
47Y-14UNS6RA380 IN2005	548
47Y-14UNT8RA21	416
47Y-14UNT8RA21 IN2005	556
47Y150ISR8RA230 IN2005	549
47Y150IST6RA17	416
47Y150IST6RA17 IN2005	557
47Y150ISTQRA13	416
47Y150ISTQRA13 IN2005	557
47Y-16UNS4RA300 IN2005	548
47Y-16UNT6RA17	416
47Y-16UNT6RA17 IN2005	556
47Y-18UNR8RA250 IN2005	548
47Y-18UNTQRA13	416
47Y-18UNTQRA13 IN2005	556
47Y200ISS4RA280 IN2005	549
47Y200ISS4RM350 IN2005	553
47Y200IST6RA17	416
47Y200IST6RA17 IN2005	557
47Y200IST8RA21	416
47Y200IST8RA21 IN2005	557
47Y-20UNS4RA280 IN2005	548
47Y-20UNTQRA13	416
47Y-20UNTQRA13 IN2005	556
47Y-24UNTQRA13	416
47Y-24UNTQRA13 IN2005	556
47Y250ISS6RA330 IN2005	549
47Y250ISS6RA480 IN2005	549
47Y250ISS6RM430 IN2005	553
47Y250IST8RA20	416
47Y250IST8RA20 IN2005	557

Designation	Page
47Y300ISS7RA430 IN2005	549
47Y300IST8RA21	416
47Y300IST8RA21 IN2005	557
48A-1004TURA20	403
48C-7562TSRN01	393
48D-3120TQRD03	398
48D-3727T6RD01	398
48D-3727T6RD03	398
48D-3727T6RD06	398
48D-5037T8RD01	398
48D-5037T8RD03	398
48D-5037T8RD06	398
48D-7562TSRN06	393
48J-1017S1RD45 IN2005	433
48J-2506R6RD25 IN2005	433
48J-2510R6RD30 IN2005	433
48J-3107R7RD25 IN2005	433
48J-3112R7RD30 IN2005	433
48J-3120TQRD04	398
48J-3708R8RD25 IN2005	433
48J-3715R8RD40 IN2005	433
48J-3727T6RD05	398
48J-4310R9RD30 IN2005	433
48J-5010S4RD30 IN2005	433
48J-5020S4RD42 IN2005	433
48J-5037T8RD06	398
48J-6212S6RD35 IN2005	433
48J-6225S6RD50 IN2005	433
48J-7515S7RD40 IN2005	433
48J-7525S7RD50 IN2005	433
48N20025TSRA45	411
48U-3719T6RB03	404
48U-3719T6RB06	404
48U-5027T8RB03	404
48U-5027T8RB06	404
48U-5027T8RB12	404
48U-6235TRRB20	404
48Y150IST8RA21	416
48Y150IST8RA21 IN2005	557
48Y200ISS7RA410 IN2005	549
49D-1088TURD12	398
49D-6247TRRD03	398
49D-6247TRRD06	398
49D-7562TSRD03	398
49D-7562TSRD06	398
49D-7562TSRD12	398
49J-6247TRRD08	398
4RB08000TQ-S100	428
4RB10000T6-S140	428
4RB16000TR-S210	428
4RB-5000T8-S060	428
4RJ08000TQ-S100	427
4RJ10000T6-S140	427
4RJ-1000TU-S140	427
4RJ16000TR-S210	427
4RJ20000TS-S260	427
4RJ-5000T8-S060	427
4W2A-04R01	198
4W2A-06R01	198
4W2A-08R01	198
4W2A-10R01	198
4W2A-12R01	198
5/32H	1058
5/32HE	1059
5/32HEX	1051
52E-11R01	199
52J-11R01	199
55E213R01	530
55E223R01	530
55F233R01	530
55F243R02	530
55F243R03	530
55F263R01	530
55G264R0	531
55G264R01	530
55G294R01	530
55H-11R07	199

INDEX

Designation	Page	Designation	Page	Designation	Page
55H-11R08	199	5V6G-20R02	284	A16T-TDUNR-3	1138
55H294R00	530	5V6H-20R01	264	A16T-TFNLN-3	1140
55H314R00	530	5V6H-30R01	264	A16T-TFNFR-3	1140
55M-11R01	199	5V6H-40R01	264	A16T-TWLNL-3	1141
55M-11R04	199	5V-11R02	199	A16T-TWLNL-4	1141
5E6H-20R01	280	5W6H-20R01	254	A16T-TWLNR-3	1141
5E6K-02R01	280	5W6H-20R02	254	A16T-TWLNR-4	1141
5E6K-03R01	280	5W6H-25R01	254	A20U-SVUNL-2.5	1133
5E6K-04R01	280	5W6H-30R01	254	A20U-SVUNR-2.5	1133
5E6K-05R01	280	5W6H-40R01	254	A20U-TCLNL-4	1137
5E6K-06R01	280	5W6J-20R01	248	A20U-TCLNR-4	1137
5E6K-25R10	280	5W6J-20R10	248	A20U-TDUNL-3	1138
5H6G-20R01	124	5W6J-20R12	248	A20U-TDUNR-3	1138
5H6G-20R02	124	5W6J-30R01	248	A20U-THSNR-4	1139
5H6G-25R01	124	5W6J-40R01	248	A20U-TTFNL-3	1140
5H6G-30R01	124	5W6J-50R01	248	A20U-TTFNR-3	1140
5H6G-30R02	124	5W6J-60R01	248	A20U-TWLNL-4	1141
5H6G-40R01	124	5W6M-30R01	254	A20U-TWLNR-4	1141
5H6G-40R02	124	5W6M-30R02	254	A22	1247
5H6G-60R02	124	5W6M-40R01	254	A24U-TCLNL-4	1137
5J1E-15R01	122	5W6M-40R02	254	A24U-TCLNR-4	1137
5J1E-20R01	122	5W6M-60R01	254	A24U-TDUNL-4	1138
5J1E-25R01	122	5W6M-60R02	254	A24U-TDUNR-4	1138
5J1E-25R02	122	5W6N-30R01	253	A24U-THSNL-4	1139
5J1E-30R01	122	5W6N-40R01	253	A24U-THSNR-4	1139
5J1E-30R02	122	5W6N-60R01	253	A24U-TWLNL-4	1141
5J1H-20R01	126	5W6R-40R01	254	A24U-TWLNR-4	1141
5J1H-30R01	126	5W6R-60R01	254	A27	1247
5J1H-40R01	126	5W6S-20R01	256	A28U-TCLNL-4	1137
5J2H-20R01	127	5W6S-40R01	257	A28U-TCLNR-4	1137
5J2H-30R01	127	5W6S-40R02	257	A28U-TDUNR-4	1138
5J2H-40R01	127	5W6S-40R20	257	A32V-TCLNL-4	1137
5J2H-50R01	127	5W6S-60R01	257	A32V-TCLNR-4	1137
5J2H-60R01	127	5W6S-60R02	257	A32V-TDUNL-4	1138
5N2H-20R00	182	5W6S-60R20	257	A32V-TDUNR-4	1138
5N2H-25R00	182	5W7G-20R01	260	A32V-THSNL-4	1139
5N2H-30R00	182	5W7H-20R01	260	A32V-THSNR-4	1139
5N2H-40R00	182	5W7H-25R01	260	ADJ BT40 D70	814
5N2H-50R00	182	5W7H-30R01	260	ADJ BT40 D70 ER32	813
5N2H-60R00	182	5W7K-20R01	260	ADJ BT50 D70	814
5N2H-80R00	182	5W7K-30R01	260	ADJ BT50 D70 ER32	813
5N6F-12R01	181	5W7K-40R01	260	ADJ CAT40 D2.756	794
5N6F-15R01	181	5W7K-50R01	260	ADJ CAT40 ER32	793
5N6F-20R01	181	5W7K-60R01	260	ADJ CAT50 D2.756	794
5N6F-25R01	181	5W7M-40R01	260	ADJ CAT50 ER32	793
5N6F-30R01	181	5W7M-60R01	260	ADJ ST1 D2.756	837
5N6H-20R00	172	5X6W-20R01	133	ADJ ST1 ER32	836
5N6H-25R00	172	5X6W-25R01	133	ADJ ST1-1/4 D2.756	837
5N6H-30R00	172	5X6W-30R01	133	ADJ ST1-1/4 ER32	836
5N6H-40R00	172	5X6W-40R01	133	AE16	1247
5N6J-20R01	188	5X6W-60R01	133	AE22	1247
5N6J-30R01	188	5X6X-20R01	134	AE22U	1249
5N6J-40R01	188	5X6X-25R01	134	AE27	1247
5N6K-25R01	174	5X6X-30R01	134	AE27U	1249
5N6K-30R01	174	5X6X-30R02	134	AG00062LLA	1058
5N6K-40R01	174	5X6X-40R01	134	AG00078LLA	1050
5N6K-50R01	174	5X6X-50R01	134	AG00093LLA	1050
5N6K-60R01	174	5X6X-60R01	134	AG00125LLA	1050
5N6L-20R01	173	5X6Z-20R01	136	AG00140LLA	1053
5N6L-30R01	173	5X6Z-30R01	136	AI16	1247
5N6L-40R01	173	5X6Z-40R01	136	AI22	1247
5N6L-60R01	173	5X6Z-50R01	136	AI22U	1249
5N6R-30R00	190	5X6Z-60R01	136	AI27	1247
5N6R-30R01	190	A12M-SDQNR-3	1129	AI27U	1253
5N6R-30R20	190	A12S-SDQNL-3	1129	ANHU160704FR-P	42
5N6R-40R00	190	A12S-SDUNL-3	1129	ANHU160704R	42
5N6R-40R01	190	A12S-SDUNR-3	1129	ANHU160708FR	42
5N6R-40R20	190	A12S-SVUNL-2.5	1133	ANHU160708FR-P	42
5N6R-50R00	190	A12S-SVUNR-2.5	1133	ANHU160708R	42
5N6R-50R01	190	A12S-TWLNL-3	1141	ANHU16071	43
5N6R-50R20	190	A12S-TWLNR-3	1141	ANHU160716R	42
5N6R-60R00	190	A16	1247	ANHU1607ANR	183
5N6R-60R01	190	A16T-SVUNL-2.5	1133	AOCT060204FR-P	15
5N6R-60R20	190	A16T-SVUNR-2.5	1133	AOCT120408FR-P	25
5N6R-80R01	190	A16T-TCLNL-4	1137	AOCT170508FR-P	35
5V6E-20R01	264	A16T-TCLNR-4	1137	AOMT060202R	15
5V6G-20R01	284	A16T-TDUNL-3	1138	AOMT060204R	15

Designation	Page
AOMT060208R	15
AOMT060216R	15
AOMT120404R	25
AOMT120408FR	25
AOMT120408R	25
AOMT120416R	25
AOMT120424R	25
AOMT120430FR	25
AOMT120432R	25
AOMT120440R	25
AOMT170504R	35
AOMT170508R	35
AOMT170508R-HS	35
AOMT170516R	35
AOMT170524R	35
AOMT170532R	35
AOMT170540R-EM	35
AOMT170548R	35
AOMT170564R	35
AOMT18	199
AOMT180504FR-P	38
AOMT180504R-HS	38
AOMT180508FR-P	38
AOMT180508R	38
AOMT180508R-HS	38
AOMT180516FR-P	38
AOMT180516R	38
AOMT180516R-HS	38
AOMT180524FR-P	38
AOMT180524R	38
AOMT180532FR-P	38
AOMT180532R	38
AOMT180548R	38
AOMT180564R	38
APKT160408L	235
APKT160408R	235
AS0002.5-5	612
AS0003.3-5	619
AS0003-5	595
AS0004-8	595
AS0005-10	595
AS0005-15	595
AS0005-5	619
AS0006-10	629
AS0006-15	595
B2.5	619
B3	619
B4	619
B5	619
BCL6	1103
BEEW120308R-CR	230
BEEW120310R-CR	230
BEEW120316R-CR	230
BEEW120320R-CR	230
BEEW120325R-CR	230
BEEW120330R-CR	230
BEEW120332R-CR	230
BEHW250304R	229
BEHW250304R-P	229
BEHW250308R	229
BEHW250308R-P	229
BEHW250316R	229
BEHW250316R-P	229
BHM 6X1X20	1107
BHM4X0.7X8	1110
BHM5X0.8X10	1103
BHM5X0.8X8	1104
BHM6X1X20	1103
BKU-100	1309
BKU-110	1309
BKU-86	1309
BLD T15/S7	511
BLDT25/S7	511
BOCT09T304FR-P	21
BOCT09T308FR-P	21
BOCT130404FR-P	33
BOMT09T304R	21

Designation	Page
BOMT09T308R	21
BOMT09T316R	21
BOMT130404R	33
BOMT130408R	33
BOMT130416R	33
BOMT130420R	33
BOMT130424R	33
BOMT130431R	33
BOMT130440R	33
BT 30	800
BT 40	800
BT 40 SRK 10X 50	807
BT 40 SRK 10X 85	807
BT 40 SRK 12X 50	807
BT 40 SRK 12X 85	807
BT 40 SRK 3X 50	807
BT 40 SRK 3X 85	807
BT 40 SRK 4X 50	807
BT 40 SRK 4X 85	807
BT 40 SRK 5X 50	807
BT 40 SRK 5X 85	807
BT 40 SRK 6X 50	807
BT 40 SRK 6X 85	807
BT 40 SRK 8X 50	807
BT 40 SRK 8X 85	807
BT 50	800
BT30 DC J2X1.187	811
BT30 DC J3X1.187	811
BT30 DC J6X1.187	811
BT30 EM 1/2X2.500	805
BT30 EM 1/4X2.500	805
BT30 EM 1X2.500	805
BT30 EM 3/4X2.500	805
BT30 EM 3/8X2.500	805
BT30 ER16X100	801
BT30 ER16X70	801
BT30 ER20 SHORT	803
BT30 ER20X70	801
BT30 ER25X 60	802
BT30 ER32X 60	802
BT30 MT1X 45	812
BT30 MT2X 60	812
BT30 SEM 1/2X2.500	808
BT30 SEM 3/4X2.500	808
BT40 DC J2X1.750	811
BT40 DC J3X1.750	811
BT40 DC J4X1.750	811
BT40 DC J6X1.750	811
BT40 EM 1 X1.750	804
BT40 EM 1/2 X1.750	804
BT40 EM 1/2X2.562	805
BT40 EM 1/4X2.375	805
BT40 EM 1-1/2X4.625	805
BT40 EM 1-1/4X2.000	804
BT40 EM 1-1/4X4.312	805
BT40 EM 1X4.125	805
BT40 EM 3/16X1.937	805
BT40 EM 3/4 X1.750	804
BT40 EM 3/8 X1.750	804
BT40 EM 3/8X2.562	805
BT40 EM 5/8 X1.750	804
BT40 EM 5/8X2.562	805
BT40 EM 7/8X4.125	805
BT40 ER16X100	801
BT40 ER16X150	801
BT40 ER16X200	801
BT40 ER16X70	801
BT40 ER20X100	801
BT40 ER20X120	801
BT40 ER20X150	801
BT40 ER20X70	801
BT40 ER25X 60	802
BT40 ER25X100	802
BT40 ER25X150	802
BT40 ER32 SHORT	803
BT40 ER32X 60	802

Designation	Page
BT40 ER32X100	802
BT40 ER32X120	802
BT40 ER32X150	802
BT40 ER32X200	802
BT40 ER40 SHORT	803
BT40 ER40X 80	802
BT40 ER40X100	802
BT40 ER40X150	802
BT40 ER40X200	802
BT40 ER50X 90	802
BT40 MT1X 45	812
BT40 MT1X120	812
BT40 MT2X 60	812
BT40 MT2X120	812
BT40 MT3X 75	812
BT40 MT3X139	812
BT40 MT4X 95	812
BT40 SEM 1/2X2.375	808
BT40 SEM 1-1/2X2.375	808
BT40 SEM 1-1/4X2.375	808
BT40 SEM 1X1.750	808
BT40 SEM 3/4X2.375	808
BT40 SRKIN 6X 90	806
BT40 SRKIN 8X 90	806
BT40 SRKIN 10X 90	806
BT40 SRKIN 12X 90	806
BT40 SRKIN 14X 90	806
BT40 SRKIN 16X 90	806
BT40 SRKIN 18X 90	806
BT40 SRKIN 20X 90	806
BT40 SRKIN 25X110	806
BT40 STUB 1-1/4X3.546	810
BT40 STUB 1X3.546	810
BT50 DC J2X1.750	811
BT50 DC J3X1.750	811
BT50 DC J4X1.750	811
BT50 DC J5X1.750	811
BT50 DC J6X1.750	811
BT50 EM 1/2X3.937	805
BT50 EM 1/4X2.750	805
BT50 EM 1-1/2X4.500	805
BT50 EM 1-1/4X4.500	805
BT50 EM 1X4.500	805
BT50 EM 2X4.937	805
BT50 EM 3/4X3.937	805
BT50 EM 3/8X2.750	805
BT50 EM 5/8X3.937	805
BT50 ER16X100	801
BT50 ER16X125	801
BT50 ER16X150	801
BT50 ER16X200	801
BT50 ER20X100	801
BT50 ER20X125	801
BT50 ER20X150	801
BT50 ER20X200	801
BT50 ER25X100	802
BT50 ER25X150	802
BT50 ER25X200	802
BT50 ER32 SHORT	803
BT50 ER32X100	802
BT50 ER32X125	802
BT50 ER32X150	802
BT50 ER32X200	802
BT50 ER40 SHORT	803
BT50 ER40X100	802
BT50 ER40X150	802
BT50 ER40X200	802
BT50 ER50X100	802
BT50 ER50X150	802
BT50 FM2-1/2X3.469	809
BT50 MT1X 45	812
BT50 MT1X120	812
BT50 MT1X180	812
BT50 MT2X 45	812
BT50 MT2X135	812
BT50 MT2X180	812

INDEX

Designation	Page
BT50 MT3X 45	812
BT50 MT3X150	812
BT50 MT3X180	812
BT50 MT4X 75	812
BT50 MT4X180	812
BT50 MT5X105	812
BT50 SEM 1-1/2X1.875	808
BT50 SEM 1-1/4X1.875	808
BT50 SEM 1X2.375	808
BT50 SEM 2 X2.375	808
BT50 SEM 3/4X2.937	808
BT50 SRKIN 6X100	806
BT50 SRKIN 8X100	806
BT50 SRKIN 10X100	806
BT50 SRKIN 12X100	806
BT50 SRKIN 14X100	806
BT50 SRKIN 16X100	806
BT50 SRKIN 18X100	806
BT50 SRKIN 20X100	806
BT50 SRKIN 25X120	806
BT50 SRKIN 32X120	806
BT50 STUB 1-1/4X3.546	810
BT50 STUB 1X3.546	810
BTA x.xxx DE4-18	635
BTA x.xxx DE4-19.5	635
BTA x.xxx DE4-21.5	635
BTA x.xxx DE4-23.5	635
BTA x.xxx DE4-26	635
BTA x.xxx DE4-28	635
BTA x.xxx DE4-30.5	635
BTA x.xxx DE4-33	635
BTA x.xxx DE4-35.5	635
BTA x.xxx DE4-39	636
BTA x.xxx DE4-42.5	636
BTA x.xxx DE4-46.5	636
BTA x.xxx DE4-51	636
BTA x.xxx DE4-55.5	636
BTA x.xxx SE4-11	633
BTA x.xxx SE4-12	633
BTA x.xxx SE4-13	633
BTA x.xxx SE4-14	633
BTA x.xxx SE4-15	633
BTA x.xxx SE4-16	633
BTA x.xxx SE4-17	633
BTA x.xxx SE4-18	633
BTA x.xxx SE4-20	633
BTA x.xxx SE4-22	633
BTA x.xxx SE4-24	633
BTA x.xxx SE4-26	633
BTA x.xxx SE4-28	633
BTA x.xxx SE4-30	633
BTA x.xxx SE4-33	633
BTA x.xxx SE4-36	634
BTA x.xxx SE4-39	634
BTA x.xxx SE4-43	634
BTA x.xxx SE4-47	634
BTA x.xxx SE4-51	634
BTA x.xxx SE4-56	634
BTA-Rx.xxxDE4-18-xxx	652
BTA-Rx.xxxDE4-19.5-xxx	652
BTA-Rx.xxxDE4-21.5-xxx	652
BTA-Rx.xxxDE4-23.5-xxx	652
BTA-Rx.xxxDE4-26-xxx	652
BTA-Rx.xxxDE4-28-xxx	652
BTA-Rx.xxxDE4-30.5-xxx	652
BTA-Rx.xxxDE4-33-xxx	652
BTA-Rx.xxxDE4-35.5-xxx	652
BTA-Rx.xxxDE4-39-xxx	652
BTA-Rx.xxxDE4-42.5-xxx	652
BTA-Rx.xxxDE4-46.5-xxx	652
BTA-Rx.xxxDE4-51-xxx	651
BTA-Rx.xxxSE4-17-xxx	651
BTA-Rx.xxxSE4-18-xxx	651
BTA-Rx.xxxSE4-20-xxx	651
BTA-Rx.xxxSE4-22-xxx	651
BTA-Rx.xxxSE4-24-xxx	651

Designation	Page
BTA-Rx.xxxSE4-26-xxx	651
BTA-Rx.xxxSE4-28-xxx	651
BTA-Rx.xxxSE4-30-xxx	651
BTA-Rx.xxxSE4-33-xxx	651
BTA-Rx.xxxSE4-36-xxx	651
BTA-Rx.xxxSE4-39-xxx	651
BTA-Rx.xxxSE4-43-xxx	651
BTA-Rx.xxxSE4-47-xxx	651
BTA-Rx.xxxSE4-51-xxx	651
BTA-Rx.xxxSE4-56-xxx	651
BTA-Rx.xxxSI1-12-xxx	650
BTA-Rx.xxxSI1-13-xxx	650
BTA-Rx.xxxSI1-14-xxx	650
BTA-Rx.xxxSI1-15-xxx	650
BTA-Rx.xxxSI1-16.5-xxx	650
BTA-Rx.xxxSI1-18-xxx	650
BTA-Rx.xxxSI1-20-xxx	650
BTA-Rx.xxxSI1-22-xxx	650
BTA-Rx.xxxSI1-24-xxx	650
BTA-Rx.xxxSI1-26-xxx	650
BTA-Rx.xxxSI1-28-xxx	650
BTA-Rx.xxxSI1-30-xxx	650
BTA-Rx.xxxSI1-32-xxx	650
BTA-Rx.xxxSI1-36-xxx	650
BTA-Rx.xxxSI1-39-xxx	650
BTA-Rx.xxxSI1-43-xxx	650
BTA-Rx.xxxSI1-47-xxx	650
BTA-Rx.xxxSI1-51-xxx	650
BTA-Rx.xxxSI1-56-xxx	650
BTDI 012	661
BTDI 014	661
BTDI 015	661
BTDI 016	622
BTDI 018	622
BTDI 020	622
BTDI 022	622
BTDI 024	622
BTDI 026	599
BTDI 029	599
BTDI 032	599
BTDI 035	599
BTDI 039	599
BTDI 043	626
BTDI 043A	599
BTDI 043B	599
BTDI 048	599
BTDI 053	599
BTDI 059	599
BTDI 066	599
BTDI 078	599
BTDI 090	661
BTDI 092	661
BTDI 104	661
BTDI 116	661
BTDI 128	661
BTDI012	635
BTDI014	635
BTDI015	635
BTDI016	635
BTDI018	635
BTDI020	635
BTDI022	635
BTDI024	635
BTDI026	635
BTDI029	636
BTDI032	636
BTDI035	636
BTDI039	636
BTDI043A	636
BTDO 018	661
BTDO 019.5	661
BTDO 021.5	661
BTDO 023.5	622
BTDO 026	622
BTDO 028	622
BTDO 030.5	622
BTDO 033	622

Designation	Page
BTDO 035.5	599
BTDO 039	599
BTDO 042.5	599
BTDO 046.5	599
BTDO 051	599
BTDO 055.5	599
BTDO 056	599
BTDO 062	599
BTDO 068	599
BTDO 075	599
BTDO 082	599
BTDO 094	599
BTDO 106	661
BTDO 118	661
BTDO 130	661
BTDO 142	661
BTDO 154	661
BTDO018	635
BTDO019.5	635
BTDO021.5	635
BTDO023.5	635
BTDO026	635
BTDO028	635
BTDO030.5	635
BTDO033.0	635
BTDO035.5	635
BTDO039	636
BTDO042.5	636
BTDO046.5	636
BTDO051	636
BTDO055.5	636
BTR04-040-ST20	657
BTR04-090-MT1	657
BTR04-xxx-xxx	654
BTR05-050-ST20	657
BTR05-100-MT1	657
BTR05-xxx-xxx	654
BTR06-050-ST20	657
BTR06-100-MT1	657
BTR06-xxx-xxx	654
BTR07-060-ST20	657
BTR07-120-MT2	657
BTR07-xxx-xxx	654
BTR08-060-ST20	657
BTR08-120-MT2	657
BTR08-xxx-xxx	654
BTR09-060-ST20	657
BTR09-120-MT2	657
BTR09-xxx-xxx	654
BTR10-xxx-xxx	654
BTR10-080-ST25	657
BTR10-150-MT3	657
BTR10-xxx-xxx	654
BTR12-100-ST25	657
BTR12-150-MT3	657
BTR12-xxx-xxx	654
BTRM x.xxx 041	656
BTRM x.xxx 051	656
BTRM x.xxx 061	656
BTRM x.xxx 071	656
BTRM x.xxx 081	656
BTRM x.xxx 091	656
BTRM x.xxx 092	656
BTRM x.xxx 101	656
BTRM x.xxx 102	656
BTRM x.xxx 103	656
BTRM x.xxx 104	656
BTRM x.xxx 121	656
BTRM x.xxx 122	656
BTRM x.xxx 123	656
BTRM x.xxx 124	656
BTRS x.xxx 041	654
BTRS x.xxx 051	654
BTRS x.xxx 061	654
BTRS x.xxx 071	654
BTRS x.xxx 081	654
BTRS x.xxx 091	654

Designation	Page
BTRS x.xxx 092	654
BTRS x.xxx 101	654
BTRS x.xxx 102	654
BTRS x.xxx 103	654
BTRS x.xxx 104	654
BTRS x.xxx 121	654
BTRS x.xxx 122	654
BTRS x.xxx 123	654
BTRS x.xxx 124	654
BTRW x.xxx 041	655
BTRW x.xxx 051	655
BTRW x.xxx 061	655
BTRW x.xxx 071	655
BTRW x.xxx 081	655
BTRW x.xxx 091	655
BTRW x.xxx 092	655
BTRW x.xxx 101	655
BTRW x.xxx 102	655
BTRW x.xxx 103	655
BTRW x.xxx 104	655
BTRW x.xxx 122	655
BTRW x.xxx 123	655
BTRW x.xxx 124	655
BTRW x.xxx 121	655
BTS x.xxx SE1-10	638
BTS x.xxx SE1-11	638
BTS x.xxx SE1-12	638
BTS x.xxx SE1-7.1	638
BTS x.xxx SE1-8.3	638
BTS x.xxx SE1-9	638
BTS x.xxx SE2-11	637
BTS x.xxx SE2-12	637
BTS x.xxx SE2-13	637
BTS x.xxx SE4-14	637
BTS x.xxx SE4-15	637
BTS x.xxx SE4-16	637
BTS x.xxx SE4-17	637
BTS x.xxx SI1-12	639
BTS x.xxx SI1-13	639
BTS x.xxx SI1-14	639
BTS x.xxx SI1-15	639
BTS x.xxx SI1-16.5	639
BTS x.xxx SI1-18	639
BTS x.xxx SI1-20	639
BTS x.xxx SI1-22	639
BTS x.xxx SI1-24	639
BTS x.xxx SI1-26	639
BTS x.xxx SI1-28	639
BTS x.xxx SI1-30	639
BTS x.xxx SI1-32	639
BTS x.xxx SI1-36	639
BTS x.xxx SI1-39	639
BTS x.xxx SI1-43	639
BTS x.xxx SI1-47	639
BTS x.xxx SI1-51	639
BTS x.xxx SI1-56	639
BTSE 012A	659
BTSE 012B	659
BTSE 013A	659
BTSE 013B	618
BTSE 014A	618
BTSE 014B	618
BTSE 015	618
BTSE 016.5	618
BTSE 018	618
BTSE 020	618
BTSE 022	618
BTSE 024	614
BTSE 026	614
BTSE 028	614
BTSE 030	614
BTSE 033	598
BTSE 036	598
BTSE 039	598
BTSE 043	598
BTSE 047	598
BTSE 051	598

Designation	Page
BTSE 056	598
BTSE 062	598
BTSE 068	598
BTSE 075	598
BTSE 082	598
BTSE 094	598
BTSE 106	604
BTSE 118	604
BTSE 130	604
BTSE 142	604
BTSE 154	604
BTSE 166	609
BTSE 178	609
BTSE 190	609
BTSE 202	609
BTSE 214	609
BTSE 226	609
BTSE012A	639
BTSE012B	639
BTSE013A	639
BTSE013B	639
BTSE014A	639
BTSE014B	639
BTSE015	639
BTSE016.5	639
BTSE018	639
BTSE020	639
BTSE022	639
BTSE024	639
BTSE026	639
BTSE028	639
BTSE030	639
BTSE032	639
BTSE036	639
BTSE039	639
BTSE043	639
BTSE047	639
BTSE051	639
BTSE056	639
BTSI 011	658
BTSI 012	658
BTSI 013	658
BTSI 014	617
BTSI 015	617
BTSI 016	617
BTSI 017	617
BTSI 018	617
BTSI 020	617
BTSI 022	617
BTSI 024	617
BTSI 026	613
BTSI 028	613
BTSI 030	613
BTSI 033	597
BTSI 036	597
BTSI 039	597
BTSI 043	597
BTSI 047	597
BTSI 051	597
BTSI 056	625
BTSI 056A	597
BTSI 056B	597
BTSI 062	597
BTSI 068	597
BTSI 075	597
BTSI 082	597
BTSI 094	597
BTSI 106	603
BTSI 118	603
BTSI 130	603
BTSI 142	603
BTSI 154	603
BTSI 166	608
BTSI 178	608
BTSI 190	608
BTSI 202	608
BTSI 214	608

Designation	Page
BTSI 226	608
BTSI011	633
BTSI012	633
BTSI013	633
BTSI014	633
BTSI015	633
BTSI016	633
BTSI017	633
BTSI018	633
BTSI020	633
BTSI022	633
BTSI024	633
BTSI026	633
BTSI028	633
BTSI030	633
BTSI033	633
BTSI036	634
BTSI039	634
BTSI043	634
BTSI047	634
BTSI051	634
BTSI056	634
BTSO 071	660
BTSO 083	660
BTSO 090	660
BTSO 100	660
BTSO 110	660
BTSO 120	660
BTSO071	638
BTSO083	638
BTSO090	638
BTSO100	638
BTSO110	638
BTSO120	638
BU-16-16	537
BU-24-44	537
BU-32-02	537
C40Z4SA-13	726
C40Z4SA-21	726
C4-TCHN	1313
C4-TCHPN	1313
C4-THSNR27050-05	1093
C50Z5SA-21	726
C5-TCHN	1313
C5-TCHPN	1313
C5-THSNR35060-05	1093
C6-TCHN	1313
C6-TCHPN	1313
C6-THSNL55065-10	1093
C6-THSNR55065-10	1093
CA40MOD08SK-020	734
CA40MOD08SK-040	734
CA40MOD10SK-020	734
CA40MOD10SK-040	734
CA40MOD12SK-040	734
CA40MOD12SK-060	734
CA40MOD16SK-040	734
CA40MOD16SK-060	734
CAT 30	778
CAT 40	778
CAT 40 SEM 1/2x2.000 C	787
CAT 40 SEM 1-1/2X2.406 C	787
CAT 40 SEM 1-1/4X2.125 C	787
CAT 40 SEM 1X2.062 C	787
CAT 40 SEM 3/4x1.375 C	787
CAT 50	778
CAT 50 SEM 1/2x3.500 C	787
CAT 50 SEM 1/2x5.500 C	787
CAT 50 SEM 1-1/2x2.500 C	787
CAT 50 SEM 1-1/2x4.000 C	787
CAT 50 SEM 1-1/4x2.000 C	787
CAT 50 SEM 1-1/4x3.500 C	787
CAT 50 SEM 1x2.000 C	787
CAT 50 SEM 1x4.000 C	787
CAT 50 SEM 3/4x2.000 C	787
CAT 50 SEM 3/4x3.500 C	787
CAT 50 SEM 3/4x5.500 C	787

INDEX

Designation	Page
CAT30 ER16X2.750	779
CAT30 ER32X3.268	780
CAT40 DC J2X1.500	790
CAT40 DC J33X1.500	790
CAT40 DC J3X1.500	790
CAT40 DC J4X1.500	790
CAT40 DC J6X1.500	790
CAT40 EM 1/2X1.750	781
CAT40 EM 1/2X2.625	782
CAT40 EM 1/4X2.500	782
CAT40 EM 1-1/2X4.625	782
CAT40 EM 1-1/4X2.000	781
CAT40 EM 1-1/4X4.250	782
CAT40 EM 1X1.750	781
CAT40 EM 1X4.000	782
CAT40 EM 3/16X2.500	782
CAT40 EM 3/4X1.750	781
CAT40 EM 3/4X3.750	782
CAT40 EM 3/8X1.750	781
CAT40 EM 3/8X2.500	782
CAT40 EM 5/8X1.750	781
CAT40 EM 5/8X3.750	782
CAT40 EM 7/8X4.000	782
CAT40 ER16X2.750	779
CAT40 ER16X3.937	779
CAT40 ER16X5.906	779
CAT40 ER20X3.937	779
CAT40 ER20X4.000	779
CAT40 ER20X5.906	779
CAT40 ER25X2.562	780
CAT40 ER25X4.000	780
CAT40 ER25X6.000	780
CAT40 ER32X 4.000	780
CAT40 ER32X 6.000	780
CAT40 ER32X2.562	780
CAT40 ER40X 4.000	780
CAT40 ER40X3.359	780
CAT40 MT 1X1.750	792
CAT40 MT 2X2.250	792
CAT40 MT 3X2.765	792
CAT40 MT 4X3.625	792
CAT40 SEM 1/2X1.500	786
CAT40 SEM 1-1/2X2.406	786
CAT40 SEM 1-1/4X2.125	786
CAT40 SEM 1X2.062	786
CAT40 SEM 3/4X1.375	786
CAT40 SRK 1/2x2.000	784
CAT40 SRK 1/2x3.250	784
CAT40 SRK 1/4x2.000	784
CAT40 SRK 1/4x3.250	784
CAT40 SRK 1/8x2.000	784
CAT40 SRK 1/8x3.250	784
CAT40 SRK 3/16x2.000	784
CAT40 SRK 3/16x3.250	784
CAT40 SRK 3/8x2.000	784
CAT40 SRK 3/8x3.250	784
CAT40 SRK 5/16x2.000	784
CAT40 SRK 5/16x3.250	784
CAT40 SRK 7/16x2.000	784
CAT40 SRK 7/16x3.250	784
CAT40 SRKIN 1 X4.000	785
CAT40 SRKIN 1/2 X3.750	785
CAT40 SRKIN 1/4X3.500	785
CAT40 SRKIN 1-1/4 X4.000	785
CAT40 SRKIN 3/4 X4.000	785
CAT40 SRKIN 3/8 X3.750	785
CAT40 SRKIN 5/16X3.500	785
CAT40 SRKIN 5/8 X3.750	785
CAT40 SRKIN 7/16X3.750	785
CAT40 SRKIN 7/8 X4.000	785
CAT40 STUB 1-1/2X4.000	789
CAT40 STUB 1-1/4X4.000	789
CAT40 STUB 1X4.000	789
CAT50 AD ISO 40X70	791
CAT50 DC J2 X1.500	790
CAT50 DC J3 X1.656	790
CAT50 DC J33X1.500	790

Designation	Page
CAT50 DC J4 X1.500	790
CAT50 DC J5 X1.625	790
CAT50 DC J6 X1.500	790
CAT50 EM 1 X4.000	783
CAT50 EM 1 X6.000	783
CAT50 EM 1 X8.000	783
CAT50 EM 1/2 X2.625	783
CAT50 EM 1/2 X4.625	783
CAT50 EM 1/2X6.625	783
CAT50 EM 1/4 X2.500	783
CAT50 EM 1/4 X4.500	783
CAT50 EM 1/4 X6.250	783
CAT50 EM 1-1/2X4.000	783
CAT50 EM 1-1/2X6.000	783
CAT50 EM 1-1/2X8.000	783
CAT50 EM 1-1/4X4.000	783
CAT50 EM 1-1/4X6.000	783
CAT50 EM 1-1/4X8.000	783
CAT50 EM 2 X5.625	783
CAT50 EM 3/4 X3.750	783
CAT50 EM 3/4 X5.750	783
CAT50 EM 3/4X7.750	783
CAT50 EM 3/8 X2.500	783
CAT50 EM 3/8 X4.500	783
CAT50 EM 3/8X6.500	783
CAT50 EM 5/8 X3.750	783
CAT50 EM 5/8X5.750	783
CAT50 EM 5/8X7.750	783
CAT50 EM 7/8 X3.750	783
CAT50 EM 7/8X5.750	783
CAT50 EM 7/8X7.750	783
CAT50 ER16X3.937	779
CAT50 ER16X5.906	779
CAT50 ER16X8.000	779
CAT50 ER20X3.937	779
CAT50 ER20X5.906	779
CAT50 ER20X8.000	779
CAT50 ER25X4.000	780
CAT50 ER25X6.000	780
CAT50 ER25X8.000	780
CAT50 ER32 X6.000	780
CAT50 ER32 X8.000	780
CAT50 ER32X4.000	780
CAT50 ER40 X4.000	780
CAT50 ER40 X6.000	780
CAT50 ER40 X8.000	780
CAT50 ER50 X4.000	780
CAT50 ER50 X6.000	780
CAT50 FM2-1/2X2.875	788
CAT50 MT 1X1.500	792
CAT50 MT 2X2.000	792
CAT50 MT 3X2.500	792
CAT50 MT 4X3.375	792
CAT50 MT 5X3.750	792
CAT50 SEM 1/2X3.500	786
CAT50 SEM 1/2X5.500	786
CAT50 SEM 1-1/2X2.406	786
CAT50 SEM 1-1/2X4.000	786
CAT50 SEM 1-1/2X6.000	786
CAT50 SEM 1-1/4X1.500	786
CAT50 SEM 1-1/4X2.92X13.0	786
CAT50 SEM 1-1/4X3.500	786
CAT50 SEM 1-1/4X4.000	786
CAT50 SEM 1-1/4X6.000	786
CAT50 SEM 1X2.000	786
CAT50 SEM 1X2.42X12.00	786
CAT50 SEM 1X4.000	786
CAT50 SEM 1X6.000	786
CAT50 SEM 2X2.406	786
CAT50 SEM 2X4.000	786
CAT50 SEM 3/4X1.500	786
CAT50 SEM 3/4X1.920X8.00	786
CAT50 SEM 3/4X3.500	786
CAT50 SEM 3/4X5.500	786
CAT50 SEM 3/4X5.500	786
CAT50 SRKIN 1 X4.000	785
CAT50 SRKIN 1/2 X3.750	785
CAT50 SRKIN 1/4 X3.500	785

Designation	Page
CAT50 SRKIN 1-1/4 X4.000	785
CAT50 SRKIN 3/4 X4.000	785
CAT50 SRKIN 3/8 X3.750	785
CAT50 SRKIN 5/16X3.500	785
CAT50 SRKIN 5/8 X3.750	785
CAT50 SRKIN 7/16X3.750	785
CAT50 SRKIN 7/8 X4.000	785
CAT50 STUB 1 X4.000	789
CAT50 STUB 1-1/2X4.000	789
CAT50 STUB 1-1/4X4.000	789
CAT50 STUB 2 X4.000	789
CAT50ODPM10X3.000	735
CAT50ODPM10X7.000	735
CAT50ODPM12X3.000	735
CAT50ODPM12X7.000	735
CAT50ODPM16X3.000	735
CAT50ODPM16X7.000	735
CAT50ODPM8X5.000	735
CB100-01	498
CB105-01	498
CB110-01	498
CB115-01	498
CB120-01	498
CB125-01	498
CB130-01	498
CB135-01	498
CB140-01	498
CB145-01	498
CB150-01	498
CB160-01	498
CB170-01	498
CB180-01	498
CB190-01	498
CB200-01	498
CC_T21.5_	1064
CC_T32.5_	1064
CC_T43_	1065
CCET0602003L-GW	961
CCET0602003R-GW	961
CCET060201L-GF	961
CCET060201R-GF	961
CCET060202L-GF	961
CCET060202R-GF	961
CCET060204L-GF	961
CCET060204R-GF	961
CCET060208L-GF	961
CCET09T3003L-GW	961
CCET09T3003R-GW	961
CCET09T301L-GF	961
CCET09T301R-GF	961
CCET09T302L-GF	961
CCET09T302R-GF	961
CCET09T304L-GF	961
CCET09T304R-GF	961
CCET09T308L-GF	961
CCET21.50.5L-GF	961
CCET21.50.5R-GF	961
CCET21.50L-GF	961
CCET21.50R-GF	961
CCET21.51L-GF	961
CCET21.51R-GF	961
CCET21.52L-GF	961
CCET21.52R-GF	961
CCET21.5X0L-GW	961
CCET21.5X0R-GW	961
CCET32.50.5L-GF	961
CCET32.50.5R-GF	961
CCET32.50L-GF	961
CCET32.50R-GF	961
CCET32.51L-GF	961
CCET32.51R-GF	961
CCET32.52L-GF	961
CCET32.52R-GF	961
CCET32.5X0L-GW	961
CCET32.5X0R-GW	961
CCGT060202FL	990
CCGT060204FL	990
CCGT09T302FL	990
CCGT09T304FL	990

Designation	Page
CCGT09T308FL	990
CCGT120402FL	990
CCGT120404FL	990
CCGT120408FL	990
CCGT21.50.5FL	990
CCGT21.51FL	990
CCGT32.50.5FL	990
CCGT32.51FL	990
CCGT32.52FL	990
CCGT430.5FL	990
CCGT431FL	990
CCGT432FL	990
CCGW 09T304WZ-LS	1008
CCGW 09T304WZ-LS2	1008
CCGW060202LN-7	1018
CCGW060202LS	1008
CCGW060204LN-7	1018
CCGW060204LS	1008
CCGW060208LN-7	1018
CCGW09RT308LN-7	1018
CCGW09T304LN-7	1018
CCGW09T304LS	1008
CCGW09T308LS	1008
CCGW09T308WZ-LS	1008
CCGW120404LN-7	1018
CCGW120404LS	1008
CCGW120408LN-7	1018
CCGW21.50.5LN-7	1018
CCGW21.50.5LS	1008
CCGW21.51LN-7	1018
CCGW21.51LS	1008
CCGW21.52LN-7	1018
CCGW32.51LN-7	1018
CCGW32.51LS	1008
CCGW32.51WZ-LS	1008
CCGW32.51WZ-LS2	1008
CCGW32.52LN-7	1018
CCGW32.52LS	1008
CCGW32.52WZ-LS	1008
CCGW431LN-7	1018
CCGW431LS	1008
CCGW432LN-7	1018
CCL4	1111
CCL5M	250
CCLNL12-4BCE	1103
CCLNL12-4BCEA	1103
CCLNR12-4BCE	1103
CCLNR16-4DCE	1103
CCLNR16-4DCEA	1103
CCMT060202FA	962
CCMT060204FA	962
CCMT060204FG	963
CCMT060204MT	964
CCMT060208MT	964
CCMT09T302FA	962
CCMT09T304FA	962
CCMT09T304FG	963
CCMT09T304MT	964
CCMT09T304PC	966
CCMT09T308FA	962
CCMT09T308FG	963
CCMT09T308MT	964
CCMT09T308WT	965
CCMT120404MT	964
CCMT120408FG	963
CCMT120408MT	964
CCMT120412MT	964
CCMT160508MT	964
CCMT21.50.5FA	962
CCMT21.51FA	962
CCMT21.51FG	963
CCMT21.51MT	964
CCMT21.52MT	964
CCMT32.50.5FA	962
CCMT32.51FA	962
CCMT32.51FG	963
CCMT32.51MT	964

Designation	Page
CCMT32.52FA	962
CCMT32.52FG	963
CCMT32.52MT	964
CCMT32.52WT	965
CCMT431MT	964
CCMT432FG	963
CCMT432MT	964
CCMT433MT	964
CCMT53.52MT	964
CCSTA5S	594
CENC 05R	595
CENC 06R	612
CENC 402-04	595
CENC 402-32	595
CENC 402-43	595
CENC 402-63	595
CENC310-12TLB	629
CENC310-16TLB	629
CENC310-16TRB	629
CENC310-22TLB	631
CENC310-22TRB	629
CKJNL16-3D	1042
CKJNL20-3E	1042
CKJNR16-3D	1042
CKJNR20-3E	1042
CKJNR85-3E	1042
CKNNR16-3D	1043
CL12	1051
CL16KL	1042
CL16KR	1042
CL19	1058
CL20	1050
CL30	1062
CL5000	259
CL6	1053
CL7	1050
CL9	1052
CLP12	1044
CLP9	1044
CLS16K	1042
CN_32_	1123
CN_33_	1087
CN_43_	1085
CN_54_	1087
CN_64_	1087
CNG_43_	1103
CNG_45_	1103
CNG431	995
CNG432	995
CNG432E	995
CNG452	995
CNG452E	995
CNG453	995
CNG453E	995
CNG454	995
CNG454E	995
CNGA120404	993
CNGA120404T2	993
CNGA120404WZ-LS	1009
CNGA120404WZ-LS2	1009
CNGA120408	993
CNGA120408E	993
CNGA120408T2	993
CNGA120408T6-WZ	994
CNGA120408WZ-LS	1009
CNGA120408WZ-LS2	1009
CNGA120412	993
CNGA120412T3	993
CNGA120412T6-WZ	994
CNGA120412T7-WZ	994
CNGA120412WZ-LS	1009
CNGA120412WZ-LS2	1009
CNGA120416	993
CNGA160612	993
CNGA190608	993
CNGA431	993
CNGA431T2	993

Designation	Page
CNGA431WZ-LS	1009
CNGA431WZ-LS2	1009
CNGA432	993
CNGA432E	993
CNGA432T2	993
CNGA432T6-WZ	994
CNGA432WZ-LS	1009
CNGA432WZ-LS2	1009
CNGA433	993
CNGA433T3	993
CNGA433T6-WZ	994
CNGA433T7-WZ	994
CNGA433WZ-LS	1009
CNGA433WZ-LS2	1009
CNGA434	993
CNGA543	993
CNGA642	993
CNGG120401ML	894
CNGG120402ML	894
CNGG120404ML	894
CNGG120408ML	894
CNGG430.5ML	894
CNGG430ML	894
CNGG431ML	894
CNGG432ML	894
CNGN120404	995
CNGN120408	995
CNGN120408E	995
CNGN120708	995
CNGN120708E	995
CNGN120712	995
CNGN120712E	995
CNGN120716	995
CNGN120716E	995
CNGX_45_CH	1143
CNGX120708T7WZ	996
CNGX120712CH	996
CNGX120712T7CH	996
CNGX120712T7WZ	996
CNGX120716CH	996
CNGX120716T7CH	996
CNGX45_CH	1111
CNGX45T7-WZ	996
CNGX453CH	996
CNGX453T7-CH	996
CNGX453T7-WZ	996
CNGX454CH	996
CNGX454T7-CH	996
CNHU060310N	282
CNHU110420N	282
CNM3225D	1010
CNM3235D	1010
CNM3245D	1010
CNMA120404	894
CNMA120404LN	1009
CNMA120404LN-10	1018
CNMA120404LS	1009
CNMA120404LS2	1009
CNMA120404LS4	1009
CNMA120408	894
CNMA120408LN	1009
CNMA120408LN-10	1018
CNMA120408LS	1009
CNMA120408LS2	1009
CNMA120408LS4	1009
CNMA120412	894
CNMA120412LN	1009
CNMA120412LN-10	1018
CNMA120412LS	1009
CNMA120412LS2	1009
CNMA120416	894
CNMA160612	894
CNMA190604	894
CNMA190608	894
CNMA190612	894
CNMA190616	894
CNMA431	894

INDEX

Designation	Page	Designation	Page	Designation	Page
CNMA431LN	1009	CNMG160612ET	897	CNMG542PC	903
CNMA431LN-10	1018	CNMG160612MP	901	CNMG543	895
CNMA431LS	1009	CNMG160612MT	902	CNMG543ET	897
CNMA431LS2	1009	CNMG160612PC	903	CNMG543MP	901
CNMA431LS4	1009	CNMG160612RT	904	CNMG543MT	902
CNMA432	894	CNMG160616MT	902	CNMG543PC	903
CNMA432LN	1009	CNMG160616PC	903	CNMG543RT	904
CNMA432LN-10	1018	CNMG160616RT	904	CNMG544MT	902
CNMA432LS	1009	CNMG190604	895	CNMG544PC	903
CNMA432LS2	1009	CNMG190608	895	CNMG544RT	904
CNMA432LS4	1009	CNMG190608MT	902	CNMG641	895
CNMA433	894	CNMG190608PC	903	CNMG642	895
CNMA433LN	1009	CNMG190608RT	904	CNMG642MT	902
CNMA433LN-10	1018	CNMG190612	895	CNMG642PC	903
CNMA433LS	1009	CNMG190612ET	897	CNMG642RT	904
CNMA433LS2	1009	CNMG190612ML	900	CNMG643	895
CNMA434	894	CNMG190612MT	902	CNMG643ET	897
CNMA543	894	CNMG190612PC	903	CNMG643ML	900
CNMA641	894	CNMG190612RT	904	CNMG643MT	902
CNMA642	894	CNMG190616	895	CNMG643PC	903
CNMA643	894	CNMG190616ET	897	CNMG643RT	904
CNMA644	894	CNMG190616MT	902	CNMG644	895
CNMG090304FG	899	CNMG190616RT	904	CNMG644ET	897
CNMG090304MP	901	CNMG250924RT	904	CNMG644MT	902
CNMG090304MT	902	CNMG321FG	899	CNMG644RT	904
CNMG090308	895	CNMG321MP	901	CNMG866RT	904
CNMG090308FG	899	CNMG321MT	902	CNMM120408RH	908
CNMG090308MP	901	CNMG322	895	CNMM120408RH(N)	908
CNMG090308MT	902	CNMG322FG	899	CNMM120412RH	908
CNMG090308PC	903	CNMG322MP	901	CNMM160608RH	908
CNMG120404	895	CNMG322MT	902	CNMM160612RH	908
CNMG120404CE	996	CNMG322PC	903	CNMM160616RH	908
CNMG120404EA	896	CNMG431	895	CNMM190608RH	908
CNMG120404FA	898	CNMG431CE	996	CNMM190612HT	906
CNMG120404FC	898	CNMG431EA	896	CNMM190612RH	908
CNMG120404FG	899	CNMG431FA	898	CNMM190612RH(N)	908
CNMG120404MC	899	CNMG431FC	898	CNMM190616HT	906
CNMG120404ML	900	CNMG431FG	899	CNMM190616RH	908
CNMG120404MP	901	CNMG431MC	899	CNMM190616RH(N)	908
CNMG120404MT	902	CNMG431ML	900	CNMM190624	907
CNMG120404PC	903	CNMG431MP	901	CNMM190624HT	906
CNMG120404SF	905	CNMG431MT	902	CNMM190624RH	908
CNMG120404WS	905	CNMG431PC	903	CNMM250724HT	906
CNMG120408	895	CNMG431SF	905	CNMM250724RH	908
CNMG120408CE	996	CNMG431WS	905	CNMM250924	907
CNMG120408EA	896	CNMG432	895	CNMM250924HT	906
CNMG120408ET	897	CNMG432CE	996	CNMM250924HZ	907
CNMG120408FA	898	CNMG432EA	896	CNMM250924RH	908
CNMG120408FC	898	CNMG432ET	897	CNMM432RH	908
CNMG120408FG	899	CNMG432FA	898	CNMM432RH(N)	908
CNMG120408MC	899	CNMG432FC	898	CNMM433RH	908
CNMG120408ML	900	CNMG432FG	899	CNMM542RH	908
CNMG120408MP	901	CNMG432MC	899	CNMM543RH	908
CNMG120408MT	902	CNMG432ML	900	CNMM544RH	908
CNMG120408PC	903	CNMG432MP	901	CNMM642RH	908
CNMG120408RT	904	CNMG432MT	902	CNMM643HT	906
CNMG120408SF	905	CNMG432PC	903	CNMM643RH	908
CNMG120408WT	906	CNMG432RT	904	CNMM643RH(N)	908
CNMG120412	895	CNMG432SF	905	CNMM644HT	906
CNMG120412ET	897	CNMG432WT	906	CNMM644RH	908
CNMG120412FC	898	CNMG433	895	CNMM644RH(N)	908
CNMG120412MC	899	CNMG433ET	897	CNMM646HT	906
CNMG120412ML	900	CNMG433FC	898	CNMM646HY	907
CNMG120412MP	901	CNMG433MC	899	CNMM646RH	908
CNMG120412MT	902	CNMG433ML	900	CNMM856HT	906
CNMG120412PC	903	CNMG433MP	901	CNMM856RH	908
CNMG120412RT	904	CNMG433MT	902	CNMM866HT	906
CNMG120412WT	906	CNMG433PC	903	CNMM866HY	907
CNMG120416	895	CNMG433RT	904	CNMM866HZ	907
CNMG120416PC	903	CNMG433WT	906	CNMM866RH	908
CNMG120416RT	904	CNMG434	895	CNMM90308SD	1010
CNMG160408	895	CNMG434PC	903	CNMM90312SD	1010
CNMG160604	895	CNMG434RT	904	CNMM90316SD	1010
CNMG160608	895	CNMG532	895	CNMM322SD	1010
CNMG160608MT	902	CNMG541	895	CNMM323SD	1010
CNMG160608PC	903	CNMG542	895	COLLET 4-18	663
CNMG160612	895	CNMG542MT	902	COLLET 4-19.5	663

Designation	Page
COLLET 4-21.5	663
COLLET 4-23.5	663
COLLET 4-26	663
COLLET 4-28	663
COLLET 4-30.5	663
COLLET 4-33	663
COLLET 4-35.5	663
COLLET 4-39	663
COLLET 4-42.5	663
COLLET 4-46.5	663
COLLET 4-51	663
COLLET 4-55.5	663
COOLING TUBE HSK A 100	867
COOLING TUBE HSK A 40	867
COOLING TUBE HSK A 50	867
COOLING TUBE HSK A 63	867
COOLING TUBE HSK A 80	867
CP_T21.5_	1127
CP_T32.5_	1127
CPGT080204C	965
CPGT090304C	965
CPGT2.51.51C	965
CPGT321C	965
CPMT060204PC	966
CPMT060208PC	966
CPMT080204FG	966
CPMT080208FG	966
CPMT090304FG	966
CPMT090308FG	966
CPMT09T308PC	966
CPMT2.51.51FG	966
CPMT2.51.52FG	966
CPMT21.51PC	966
CPMT21.52PC	966
CPMT32.51PC	966
CPMT32.52PC	966
CPMT321FG	966
CPMT322FG	966
CRDNN12-4BCE	1104
CRDNN12-4BCEA	1104
CRDNN16-4DCE	1104
CRDNN16-4DCEA	1104
CRGNN16-4DCE	1105
CRGNN16-4DCEA	1105
CRGNN20-4ECE	1105
CRGNN12-4BCEA	1105
CRGNN16-4DCE	1105
CRGNN16-4DCEA	1105
CRGNN20-4ECE	1105
CS126	1044
CS96	1044
CSC4	1111
CSDNN12-4BCEA	1106
CSDNN16-4CE	1106
CSDNN16-4DCEA	1106
CSDNN20-4ECE	1106
CSDPN10-3B	1044
CSDPN12-3B	1044
CSDPN12-4B	1044
CSDPN16-4D	1044
CSDPN16-6D	1044
CSK1604L	1042
CSK1604R	1042
CSKNL16-4DCE	1107
CSKNR16-4DCE	1107
CSKNR16-4DCEA	1107
CSRNR16-4DCEA	1108
CSSNR16-4DCEA	1109
CSTA3	641
CSTA4-7.5	616
CSTA5	595
CSTA5S	594
CSTAN03	647
CSTAN03-4.5	616
CSTAN05-5.5	616
CSTAN05-6.5	616
CSTB 2.2S	612

Designation	Page
CSTB 2.5	620
CSTB 3.5	627
CSTB 3.5S	620
CSTB 3S	627
CSTB 3S	612
CSTB2.2	593
CSTB2.2S	615
CSTB2.5	593
CSTB3	595
CSTB3.5	595
CSTB3.5D	593
CSTB3S	594
CSTB4	649
CSTB4M	593
CSTB4S	594
CSTB5	593
CSTB5S	602
CTAPL06-2J	1045
CTAPL08-2J	1045
CTAPL10-2B	1045
CTAPL12-3B	1045
CTAPL16-3D	1045
CTAPL16-4D	1045
CTAPR06-2J	1045
CTAPR08-2J	1045
CTAPR10-2B	1045
CTAPR12-3B	1045
CTAPR16-3D	1045
CTAPR16-4D	1045
CTCON08-3J	1046
CTCON12-4B	1046
CTCON44-3F	1046
CTCON64-4F	1046
CTCON66-4F	1046
CTFPL10-3B	1047
CTFPL12-3B	1047
CTFPL12-4B	1047
CTFPL16-3D	1047
CTFPL16-4D	1047
CTFPL20-4D	1047
CTFPR10-3B	1047
CTFPR12-3B	1047
CTFPR12-4B	1047
CTFPR16-3D	1047
CTFPR16-4D	1047
CTFPR20-4D	1047
CTGPL10-3B	1048
CTGPL12-3B	1048
CTGPL16-4D	1048
CTGPL20-4D	1048
CTGPR10-3B	1048
CTGPR12-3B	1048
CTGPR16-4D	1048
CTGPR20-4D	1048
CTJNR12-3BCEA	1110
CTJNR16-3DCEA	1110
CZ_0090	87
DC_T21.5_	1067
DC_T32.5_	1067
DCET0702003L-GW	967
DCET0702003R-GW	967
DCET070201L-GF	967
DCET070201R-GF	967
DCET070202L-GF	967
DCET070202R-GF	967
DCET070204L-GF	967
DCET070204R-GF	967
DCET11T3003L-GW	967
DCET11T3003R-GW	967
DCET11T301L-GF	967
DCET11T301R-GF	967
DCET11T302L-GF	967
DCET11T302R-GF	967
DCET11T304L-GF	967
DCET11T304R-GF	967
DCET21.50.5L-GF	967
DCET21.50.5R-GF	967

Designation	Page
DCET21.50L-GF	967
DCET21.50R-GF	967
DCET21.51L-GF	967
DCET21.51R-GF	967
DCET21.5X0L-GW	967
DCET21.5X0R-GW	967
DCET32.50.5L-GF	967
DCET32.50.5R-GF	967
DCET32.50L-GF	967
DCET32.50R-GF	967
DCET32.51L-GF	967
DCET32.51R-GF	967
DCET32.5X0L-GW	967
DCET32.5X0R-GW	967
DCGT070202FL	990
DCGT070204FL	990
DCGT11T302FL	990
DCGT11T304FL	990
DCGT11T308FL	990
DCGT21.50.5FL	990
DCGT21.51FL	990
DCGT32.50.5FL	990
DCGT32.51FL	990
DCGT32.52FL	990
DCGW070202LN-7	1019
DCGW070202LS	1010
DCGW070204LN-7	1019
DCGW070204LS	1010
DCGW070208LS	1010
DCGW11T302LN-7	1019
DCGW11T304LN-7	1019
DCGW11T304LS	1010
DCGW11T308LN-7	1019
DCGW11T308LS	1010
DCGW21.50.5LN-7	1019
DCGW21.50.5LS	1010
DCGW21.51LN-7	1019
DCGW21.51LS	1010
DCGW21.52LS	1010
DCGW32.50.5LN-7	1019
DCGW32.51LN-7	1019
DCGW32.51LS	1010
DCGW32.52LN-7	1019
DCGW32.52LS	1010
DCMT070202FA	968
DCMT070204FG	969
DCMT070208FG	969
DCMT11T302FA	968
DCMT11T304FG	969
DCMT11T304MT	970
DCMT11T308FG	969
DCMT11T308MT	970
DCMT11T312MT	970
DCMT21.50.5FA	968
DCMT21.51FG	969
DCMT21.52FG	969
DCMT32.50.5FA	968
DCMT32.51FG	969
DCMT32.51MT	970
DCMT32.52FG	969
DCMT32.52MT	970
DCMT32.53MT	970
DG6H-20R01	271
DG6H-20R02	271
DG6H-25R01	271
DG6H-30R01	271
DG6H-30R02	271
DG6H-40R01	271
DG6H-60R01	271
DGE314R001	49
DGE314R002	49
DGE314R004	49
DGE324R001	87
DGE324R002	87
DGE324R004	143
DGE324R045	194
DGM212R100	45

INDEX

Designation	Page
DGM212R101	45
DGM212R103	45
DGM314	292
DGM314R001	49
DGM314R002	49
DGM314R003	49
DGM314R004	49
DGM324	292
DGM324R001	87
DGM324R002	87
DGM324R003	87
DGM324R004	143
DGM324R045	194
DGM324R201	87
DGM324R202	87
DHU-07512X6R10	297
DHU-10012X7R01	297
DHU-10012X7R10	297
DHU-12015X8R01	297
DHU-12015X8R02	297
DHU-15017X8R02	297
DHU-20017D1R01	298
DHU-25017D1R0	298
DHU-30017D3R01	298
DHU-40020D4R01	298
DJ1H100R00	128
DJ1H125R00	128
DJ1H-20R01	128
DJ1H-30R01	128
DJ1H-40R01	128
DJ1H-40R02	128
DJ1H-60R01	128
DJ1H-60R02	128
DJ1H-80R01	128
DJ1H-80R02	128
DJ5H-25R01	132
DJ5H-30R01	132
DJ5H-40R01	132
DJ5H-60R01	132
DJ5T-30R01	130
DJ5T-40R01	130
DJ5T-50R01	130
DJ5T-60R01	130
DJ5T-80R01	130
DJ6H-25R01	132
DJ6H-30R01	132
DJ6H-40R01	132
DJ6H-60R01	132
DJ6T-20R01	130
DJ6T-25R01	130
DJ6T-30R01	130
DJ6T-40R01	130
DJ6T-50R01	130
DJ6T-60R01	130
DJ6T-80R01	130
DL5H-20R01	184
DL5H-25R01	184
DL5H-30R01	184
DL5H-40R01	184
DL5H-60R01	184
DL6H-20R01	184
DL6H-25R01	184
DL6H-30R01	184
DL6H-40R01	184
DL6H-60R01	184
DLM3	1087
DLM3-V16	1100
DLM4	1085
DLM5	1087
DLM6	1087
DLS3	1087
DLS4	1085
DLS4-18L	250
DLS5	1087
DM2Q-06R01	180
DM2Q-08R01	180
DM2Q-10R01	180

Designation	Page
DM2Q-12R01	180
DM5G-20R01	176
DM5G-25R01	176
DM5G-30R01	176
DM5G-40R01	176
DM5G-50R01	176
DM5G-60R01	176
DM5Q-04R01	178
DM5Q-06R01	178
DM5Q-08R01	178
DM6G-15R01	176
DM6G-20R01	176
DM6G-25R01	176
DM6G-30R01	176
DM6G-40R01	176
DM6G-50R01	176
DM6G-60R01	176
DM6G-80R10	176
DM6Q-03R01	178
DM6Q-04R01	178
DM6Q-05R01	178
DM6Q-06R01	178
DM6Q-08R01	178
DM6Q-10R01	178
DM6Q-12R01	178
DN_33_	1050
DN_43_	1050
DN_44_	1090
DN5H-20R01	186
DN5H-25R01	186
DN5H-30R01	186
DN5H-40R01	186
DN5H-60R01	186
DN6H-20R01	186
DN6H-25R01	186
DN6H-30R01	186
DN6H-40R01	186
DN6H-50R01	186
DN6H-60R01	186
DNGA150404	997
DNGA150408	997
DNGA150408T6WZ	997
DNGA150604	997
DNGA150608	997
DNGA150612	997
DNGA431	997
DNGA432	997
DNGA432T6WZ	997
DNGA441	997
DNGA442	997
DNGA443	997
DNGG150404ML	909
DNGG150408ML	909
DNGG431ML	909
DNGG432ML	909
DNGX120708T7-CH	997
DNGX120712T7-CH	997
DNGX150708T7-CH	997
DNGX150712CH	997
DNGX150712T7-CH	997
DNGX150716CH	997
DNGX45_CH	1112
DNGX452T7-CH	997
DNGX453CH	997
DNGX453T7-CH	997
DNGX454CH	997
DNM434L201	89
DNM434L202	89
DNM434R201	89
DNM434R202	89
DNM434R203	89
DNM434R204	89
DNM434R245	197
DNMA110408	909
DNMA110412	909
DNMA150404	909
DNMA150404LN	1011

Designation	Page
DNMA150404LN-10	1019
DNMA150404LS	1011
DNMA150404LS2	1011
DNMA150404LS4	1011
DNMA150408	909
DNMA150408LN	1011
DNMA150408LN-10	1019
DNMA150408LS	1011
DNMA150408LS2	1011
DNMA150412	909
DNMA150412LN	1011
DNMA150604	909
DNMA150604LN	1011
DNMA150604LN-10	1019
DNMA150604LS	1011
DNMA150604LS2	1011
DNMA150604WZ-LS	1011
DNMA150608	909
DNMA150608LN	1011
DNMA150608LN-10	1019
DNMA150608WZ-LN	1011
DNMA150612	909
DNMA332	909
DNMA333	909
DNMA431	909
DNMA431LN	1011
DNMA431LN-10	1019
DNMA431LS	1011
DNMA431LS2	1011
DNMA431LS4	1011
DNMA432	909
DNMA432LN	1011
DNMA432LN-10	1019
DNMA432LS	1011
DNMA432LS2	1011
DNMA433	909
DNMA433LN	1011
DNMA441	909
DNMA441LN	1011
DNMA441LN-10	1019
DNMA441LS	1011
DNMA441LS2	1011
DNMA441WZ-LS	1011
DNMA442	909
DNMA442LN	1011
DNMA442LN-10	1019
DNMA442WZ-LN	1011
DNMA443	909
DNMG110404FC	911
DNMG110404FG	912
DNMG110408FC	911
DNMG110408FG	912
DNMG110408MT	915
DNMG110408PC	916
DNMG110412MT	915
DNMG150404	910
DNMG150404FC	911
DNMG150404FG	912
DNMG150404ML	913
DNMG150404MP	914
DNMG150404MT	915
DNMG150404PC	916
DNMG150408	910
DNMG150408FA	911
DNMG150408FC	911
DNMG150408FG	912
DNMG150408MC	913
DNMG150408ML	913
DNMG150408MP	914
DNMG150408MT	915
DNMG150408PC	916
DNMG150408RT	917
DNMG150412	910
DNMG150412FG	912
DNMG150412MC	913
DNMG150412MT	915
DNMG150412PC	916

Designation	Page
DNMG150412RT	917
DNMG150416	910
DNMG150604	910
DNMG150604FC	911
DNMG150604FG	912
DNMG150604MC	913
DNMG150604ML	913
DNMG150604MP	914
DNMG150604MT	915
DNMG150604PC	916
DNMG150608	910
DNMG150608CE	998
DNMG150608FA	911
DNMG150608FC	911
DNMG150608FG	912
DNMG150608MC	913
DNMG150608ML	913
DNMG150608MP	914
DNMG150608MT	915
DNMG150608PC	916
DNMG150608RT	917
DNMG150612	910
DNMG150612MC	913
DNMG150612MP	914
DNMG150612MT	915
DNMG150612PC	916
DNMG150612RT	917
DNMG150616	910
DNMG150616RT	917
DNMG331FC	911
DNMG331FG	912
DNMG332FC	911
DNMG332FG	912
DNMG332MT	915
DNMG332PC	916
DNMG333MT	915
DNMG431	910
DNMG431FC	911
DNMG431FG	912
DNMG431ML	913
DNMG431MP	914
DNMG431MT	915
DNMG431PC	916
DNMG432	910
DNMG432FA	911
DNMG432FC	911
DNMG432FG	912
DNMG432MC	913
DNMG432ML	913
DNMG432MP	914
DNMG432MT	915
DNMG432PC	916
DNMG432RT	917
DNMG433	910
DNMG433FG	912
DNMG433MC	913
DNMG433MT	915
DNMG433PC	916
DNMG433RT	917
DNMG434	910
DNMG441	910
DNMG441FC	911
DNMG441FG	912
DNMG441MC	913
DNMG441ML	913
DNMG441MP	914
DNMG441MT	915
DNMG441PC	916
DNMG442	910
DNMG442CE	998
DNMG442FA	911
DNMG442FC	911
DNMG442FG	912
DNMG442MC	913
DNMG442ML	913
DNMG442MP	914
DNMG442MT	915

Designation	Page
DNMG442PC	916
DNMG442RT	917
DNMG443	910
DNMG443MC	913
DNMG443MP	914
DNMG443MT	915
DNMG443PC	916
DNMG443RT	917
DNMG444	910
DNMG444RT	917
DP5G-20R01	276
DP5G-20R02	276
DP5G-25R01	276
DP5G-30R01	276
DP5G-40R01	276
DP5G-60R01	276
DPM314	214
DPM314-001	215
DPM314-002	215
DPM314-003	215
DPM314-004	215
DPM324	214
DPM324-001	215
DPM324-002	215
DPM324-003	215
DPM324-004	215
DPM324L050	299
DPM324L051	273
DPM324L101	273
DPM324R001	88
DPM324R002	88
DPM424	214
DPM424-001	215
DPM424-002	215
DPM424-003	215
DPM424-004	215
DPM424R001	88
DPM434	272
DPM434L050	299
DPM434L051	273
DPM434L101	273
DPM434R001	147
DPM434R002	147
DPM434R003	147
DPM434R004	147
DPM434R045	197
DPM435R045	197
DPM436R001	151
DPM436R002	151
DPM436R003	151
DPM436R004	151
DPM436R045	200
DR-0031	206
DR-0032	206
DR0300024T7R01 IN2005	494
DR0310023T7R01 IN2005	494
DR0320023T7R01 IN2005	494
DR0330023T7R01 IN2005	494
DR0340023T7R01 IN2005	494
DR0350023T7R01 IN2005	494
DR0360023T7R01 IN2005	494
DR0370022T7R01 IN2005	494
DR0380030T7R01 IN2005	494
DR0390030T7R01 IN2005	494
DR0400030T7R01 IN2005	494
DR0410030T7R01 IN2005	494
DR0420030T7R01 IN2005	494
DR0430030T7R01 IN2005	494
DR0440029T7R01 IN2005	494
DR0450029T7R01 IN2005	494
DR0460029T7R01 IN2005	494
DR0470029T7R01 IN2005	494
DR0480037T7R01 IN2005	494
DR0490037T7R01 IN2005	494
DR0500037T7R01 IN2005	494
DR0510036T7R01 IN2005	494
DR0520036T7R01 IN2005	494

Designation	Page
DR0530036T7R01 IN2005	494
DR0540036T7R01 IN2005	494
DR0550036T7R01 IN2005	494
DR0560036T7R01 IN2005	494
DR0570035T7R01 IN2005	494
DR0580035T7R01 IN2005	494
DR0590035T7R01 IN2005	494
DR0600035T7R01 IN2005	494
DR0610044T0R01 IN2005	494
DR0620044T0R01 IN2005	494
DR0630044T0R01 IN2005	494
DR0640043T0R01 IN2005	494
DR0650043T0R01 IN2005	494
DR0660043T0R01 IN2005	494
DR0670043T0R01 IN2005	494
DR0680043T0R01 IN2005	494
DR0690043T0R01 IN2005	494
DR0700043T0R01 IN2005	495
DR0710042T0R01 IN2005	495
DR0720042T0R01 IN2005	495
DR0730042T0R01 IN2005	495
DR0740042T0R01 IN2005	495
DR0750042T0R01 IN2005	495
DR0760042T0R01 IN2005	495
DR0770041T0R01 IN2005	495
DR0780041T0R01 IN2005	495
DR0790041T0R01 IN2005	495
DR0800041T0R01 IN2005	495
DR0810049T1R01 IN2005	495
DR0820049T1R01 IN2005	495
DR0830049T1R01 IN2005	495
DR0840048T1R01 IN2005	495
DR0850048T1R01 IN2005	495
DR0860048T1R01 IN2005	495
DR0870048T1R01 IN2005	495
DR0880048T1R01 IN2005	495
DR0890048T1R01 IN2005	495
DR0900048T1R01 IN2005	495
DR0910047T1R01 IN2005	495
DR0920047T1R01 IN2005	495
DR0930047T1R01 IN2005	495
DR0940047T1R01 IN2005	495
DR0950047T1R01 IN2005	495
DR0960047T1R01 IN2005	495
DR0970046T1R01 IN2005	495
DR0980046T1R01 IN2005	495
DR0990046T1R01 IN2005	495
DR1000046T1R01 IN2005	495
DR1010056T2R01 IN2005	495
DR1020056T2R01 IN2005	495
DR1030056T2R01 IN2005	495
DR1040055T2R01 IN2005	495
DR1050055T2R01 IN2005	495
DR1060055T2R01 IN2005	495
DR1070055T2R01 IN2005	495
DR1080055T2R01 IN2005	495
DR1090055T2R01 IN2005	495
DR1100055T2R01 IN2005	496
DR1110054T2R01 IN2005	496
DR1120054T2R01 IN2005	496
DR1130054T2R01 IN2005	496
DR1140054T2R01 IN2005	496
DR1150054T2R01 IN2005	496
DR1160054T2R01 IN2005	496
DR1170053T2R01 IN2005	496
DR1180053T2R01 IN2005	496
DR1190053T2R01 IN2005	496
DR1200053T2R01 IN2005	496
DRXL0500100U1R01	497
DRXL0600120T7R01	497
DRXL0635127R6R01	497
DRXL0700140UAR01	497
DRXL0793158R7R01	497
DRXL0800160TOR01	497
DRXL0900180U9R01	497
DRXL0952190R8R01	497
DRXL1000200T1R01	497

INDEX

Designation	Page
DS-0022	421
DS-0038	421
DS07-080-01	530
DS09-080-01	530
DS09-159-01	530
DS11-080-01	530
DS11-159-01	530
DS11-238-01	530
DS11-320-01	530
DS-H03T	198
DS-H04T	169
DS-H05HB	511
DS-H05T	180
DSP3	1087
DSP4	250
DSP5	1087
DS-T06F	293
DS-T07F	235
DS-T08S	1254
DS-T08W	21
DS-T09W	53
DS-T10T	25
DS-T15S	1064
DS-T15T	31
DS-T15T (Tx-15)	97
DS-T20	189
DS-T20B	413
DS-T20T	61
DS-T25B	414
DS-T25T	253
DS-T30B	414
DS-T30T	414
DS-T40B	414
DS-T40T	414
DS-T50B	414
DS-T50L	414
DS-TP06S	15
DS-TP06TB	15
DS-TP08S	263
DT-130-10	392
DT-250-13	392
DT-250-16	392
DT-60-06	392
DT-90-08	392
DTC-3R	662
DTC-3S	662
DTC-3SRF	662
DTC-4R	662
DTC-4RF	662
DTC-4S	662
DTC-5R	662
DTC-5RF	662
DTC-5S	662
DTC-6R	662
DTM324R001	88
DTN005S	15
DW1H-20R01	251
DW2H-20R01	251
DW2H-30R01	251
E06M-SCLCL-2	1125
E06M-SCLCR-2	1125
E06M-SDUCR-2	1128
E06M-STFCL-2	1130
E06M-STFCR-2	1130
E08M-SCLCL-2	1125
E08M-SCLCR-2	1125
E08M-SDUCR-2	1128
E08R-SCLCL-3	1125
E08R-SCLCR-3	1125
E08R-STFCL-2	1130
E08R-STFCR-2	1130
E10R-SCLCL-3	1125
E10R-SCLCR-3	1125
E10R-SDUCR-2	1128
E10R-STFCL-2	1130
E10R-STFCR-2	1130
E-11	840

Designation	Page
E12S-SCLCL-3	1125
E12S-SCLCR-3	1125
E12S-SDUCR-3	1128
E12S-STFCL-2	1130
E12S-STFCR-2	1130
E16T-SCLCR-3	1125
E16T-SDUCR-3	1128
EDG-23B	1304
EDG-33B	1304
ER-11	839
ER11 SPR .022-.041	841
ER11 SPR .022-.041 AA	842
ER11 SPR .041-.080	841
ER11 SPR .041-.080 AA	842
ER11 SPR .080-.120	841
ER11 SPR .080-.120 AA	842
ER11 SPR .120-.159	841
ER11 SPR .120-.159 AA	842
ER11 SPR .159-.199	841
ER11 SPR .159-.199 AA	842
ER11 SPR .199-.238	841
ER11 SPR .199-.238 AA	842
ER11 SPR .238-.278	841
ER11 SPR .238-.278 AA	842
ER-11M	840
ER11T05SA-02	425
ER11T05SA-05	425
ER-16	839
ER16 SEAL .120-.159	843
ER16 SEAL .120-.159 JET2	844
ER16 SEAL .159-.199	843
ER16 SEAL .159-.199 JET2	844
ER16 SEAL .199-.238	843
ER16 SEAL .199-.238 JET2	844
ER16 SEAL .238-.278	843
ER16 SEAL .238-.278 JET2	844
ER16 SEAL .278-.317	843
ER16 SEAL .278-.317 JET2	844
ER16 SEAL .317-.356	843
ER16 SEAL .317-.356 JET2	844
ER16 SEAL .356-.396	843
ER16 SEAL .356-.396 JET2	844
ER16 SPR .022-.041	841
ER16 SPR .022-.041 AA	842
ER16 SPR .041-.080	841
ER16 SPR .041-.080 AA	842
ER16 SPR .080-.120	841
ER16 SPR .080-.120 AA	842
ER16 SPR .120-.159	841
ER16 SPR .120-.159 AA	842
ER16 SPR .159-.199	841
ER16 SPR .159-.199 AA	842
ER16 SPR .199-.238	841
ER16 SPR .199-.238 AA	842
ER16 SPR .238-.278	841
ER16 SPR .238-.278 AA	842
ER16 SPR .278-.317	841
ER16 SPR .278-.317 AA	842
ER16 SPR .317-.356	841
ER16 SPR .317-.356 AA	842
ER16 SPR .356-.396	841
ER16 SPR .356-.396 AA	842
ER-16M	840
ER16T05SA-02	425
ER16T05SA-05	425
ER16T06SA-02	425
ER16T06SA-05	425
ER16T08SA-02	425
ER16T08SA-06	425
ER-20	839
ER20 SEAL .120-.159	843
ER20 SEAL .120-.159 JET2	844
ER20 SEAL .159-.199	843
ER20 SEAL .159-.199 JET2	844
ER20 SEAL .199-.238	843
ER20 SEAL .199-.238 JET2	844
ER20 SEAL .238-.278	843
ER20 SEAL .238-.278 JET2	844

Designation	Page
ER20 SEAL .238-.278 JET2	844
ER20 SEAL .278-.317	843
ER20 SEAL .278-.317 JET2	844
ER20 SEAL .317-.356	843
ER20 SEAL .317-.356 JET2	844
ER20 SEAL .356-.396	843
ER20 SEAL .356-.396 JET2	844
ER20 SEAL .396-.435	843
ER20 SEAL .396-.435 JET2	844
ER20 SEAL .435-.474	843
ER20 SEAL .435-.474 JET2	844
ER20 SEAL .474-.514	843
ER20 SEAL .474-.514 JET2	844
ER20 SPR .041-.080	841
ER20 SPR .041-.080 AA	842
ER20 SPR .080-.120	841
ER20 SPR .080-.120 AA	842
ER20 SPR .120-.159	841
ER20 SPR .120-.159 AA	842
ER20 SPR .159-.199	841
ER20 SPR .159-.199 AA	842
ER20 SPR .199-.238	841
ER20 SPR .199-.238 AA	842
ER20 SPR .238-.278	841
ER20 SPR .238-.278 AA	842
ER20 SPR .278-.317	841
ER20 SPR .278-.317 AA	842
ER20 SPR .317-.356	841
ER20 SPR .317-.356 AA	842
ER20 SPR .356-.396	841
ER20 SPR .356-.396 AA	842
ER20 SPR .396-.435	841
ER20 SPR .396-.435 AA	842
ER20 SPR .435-.474	841
ER20 SPR .435-.474 AA	842
ER20 SPR .474-.514	841
ER20 SRK 1/4X1.500	849
ER20 SRK 1/4X2.500	849
ER20 SRK 1/8X1.500	849
ER20 SRK 1/8X2.500	849
ER20 SRK 3/16X1.500	849
ER20 SRK 3/16X2.500	849
ER20 SRK 3X35	850
ER20 SRK 3X60	850
ER20 SRK 4X35	850
ER20 SRK 4X60	850
ER20 SRK 5X35	850
ER20 SRK 5X60	850
ER20 SRK 6X35	850
ER20 SRK 6X60	850
ER-20M	840
ER20T05SA-02	425
ER20T05SA-05	425
ER20T06SA-02	425
ER20T06SA-05	425
ER20T08SA-02	425
ER20T08SA-06	425
ER20T10SA-02	425
ER20T10SA-07	425
ER-25	839
ER25 SEAL .120-.159	843
ER25 SEAL .120-.159 JET2	844
ER25 SEAL .159-.199	843
ER25 SEAL .159-.199 JET2	844
ER25 SEAL .199-.238	843
ER25 SEAL .199-.238 JET2	844
ER25 SEAL .238-.278	843
ER25 SEAL .238-.278 JET2	844
ER25 SEAL .278-.317	843
ER25 SEAL .278-.317 JET2	844
ER25 SEAL .317-.356	843
ER25 SEAL .317-.356 JET2	844
ER25 SEAL .356-.396	843
ER25 SEAL .356-.396 JET2	844
ER25 SEAL .396-.435	843
ER25 SEAL .396-.435 JET2	844
ER25 SEAL .435-.474	843

Designation	Page
ER25 SEAL .435-.474 JET2	844
ER25 SEAL .474-.514	843
ER25 SEAL .474-.514 JET2	844
ER25 SEAL .514-.553	843
ER25 SEAL .514-.553 JET2	844
ER25 SEAL .553-.593	843
ER25 SEAL .553-.593 JET2	844
ER25 SEAL .593-.632	843
ER25 SEAL .593-.632 JET2	844
ER25 SPR .041-.080	841
ER25 SPR .041-.080 AA	842
ER25 SPR .080-.120	841
ER25 SPR .080-.120 AA	842
ER25 SPR .120-.159	841
ER25 SPR .120-.159 AA	842
ER25 SPR .159-.199	841
ER25 SPR .159-.199 AA	842
ER25 SPR .199-.238	841
ER25 SPR .199-.238 AA	842
ER25 SPR .238-.278	841
ER25 SPR .238-.278 AA	842
ER25 SPR .278-.317	841
ER25 SPR .278-.317 AA	842
ER25 SPR .317-.356	841
ER25 SPR .317-.356 AA	842
ER25 SPR .356-.396	841
ER25 SPR .356-.396 AA	842
ER25 SPR .396-.435	841
ER25 SPR .396-.435 AA	842
ER25 SPR .435-.474	841
ER25 SPR .435-.474 AA	842
ER25 SPR .474-.514	841
ER25 SPR .474-.514 AA	842
ER25 SPR .514-.553	841
ER25 SPR .514-.553 AA	842
ER25 SPR .553-.593	841
ER25 SPR .553-.593 AA	842
ER25 SPR .593-.632	841
ER25 SPR .593-.632 AA	842
ER25 SRK 1/4X1.500	849
ER25 SRK 1/4X2.500	849
ER25 SRK 1/8X1.500	849
ER25 SRK 1/8X2.500	849
ER25 SRK 3/16X1.500	849
ER25 SRK 3/16X2.500	849
ER25 SRK 3X35	850
ER25 SRK 3X60	850
ER25 SRK 4X35	850
ER25 SRK 4X60	850
ER25 SRK 5/16X1.500	849
ER25 SRK 5/16X2.500	849
ER25 SRK 5X35	850
ER25 SRK 5X60	850
ER25 SRK 6X35	850
ER25 SRK 6X60	850
ER25 SRK 8X35	850
ER25 SRK 8X60	850
ER-32	839
ER32 EX .125	841
ER32 EX .250	841
ER32 EX .312	841
ER32 EX .375	841
ER32 EX .500	841
ER32 EX .625	841
ER32 EX .750	841
ER32 SEAL .120-.159	843
ER32 SEAL .120-.159 JET2	844
ER32 SEAL .159-.199	843
ER32 SEAL .159-.199 JET2	844
ER32 SEAL .199-.238	843
ER32 SEAL .199-.238 JET2	844
ER32 SEAL .238-.278	843
ER32 SEAL .238-.278 JET2	844
ER32 SEAL .278-.317	843
ER32 SEAL .278-.317 JET2	844
ER32 SEAL .317-.356	843
ER32 SEAL .317-.356 JET2	844

Designation	Page
ER32 SEAL .356-.396	843
ER32 SEAL .356-.396 JET2	844
ER32 SEAL .396-.435	843
ER32 SEAL .396-.435 JET2	844
ER32 SEAL .435-.474	843
ER32 SEAL .435-.474 JET2	844
ER32 SEAL .474-.514	843
ER32 SEAL .474-.514 JET2	844
ER32 SEAL .514-.553	843
ER32 SEAL .514-.553 JET2	844
ER32 SEAL .553-.593	843
ER32 SEAL .553-.593 JET2	844
ER32 SEAL .593-.632	843
ER32 SEAL .593-.632 JET2	844
ER32 SEAL .632-.671	843
ER32 SEAL .632-.671 JET2	844
ER32 SEAL .671-.711	843
ER32 SEAL .671-.711 JET2	844
ER32 SEAL .711-.750	843
ER32 SEAL .711-.750 JET2	844
ER32 SEAL .750-.789	843
ER32 SEAL .750-.789 JET2	844
ER32 SPR .080-.120	841
ER32 SPR .080-.120 AA	842
ER32 SPR .120-.159	841
ER32 SPR .120-.159 AA	842
ER32 SPR .159-.199	841
ER32 SPR .159-.199 AA	842
ER32 SPR .199-.238	841
ER32 SPR .199-.238 AA	842
ER32 SPR .238-.278	842
ER32 SPR .278-.317	841
ER32 SPR .278-.317 AA	842
ER32 SPR .317-.356	841
ER32 SPR .317-.356 AA	842
ER32 SPR .356-.396	841
ER32 SPR .356-.396 AA	842
ER32 SPR .396-.435	841
ER32 SPR .396-.435 AA	842
ER32 SPR .435-.474	841
ER32 SPR .435-.474 AA	842
ER32 SPR .474-.514	841
ER32 SPR .474-.514 AA	842
ER32 SPR .514-.553	841
ER32 SPR .514-.553 AA	842
ER32 SPR .553-.593	841
ER32 SPR .553-.593 AA	842
ER32 SPR .593-.632	841
ER32 SPR .593-.632 AA	842
ER32 SPR .632-.671	841
ER32 SPR .632-.671 AA	842
ER32 SPR .671-.711	841
ER32 SPR .671-.711 AA	842
ER32 SPR .711-.750	842
ER32 SPR .711-.750 AA	841
ER32 SPR .750-.789	841
ER32 SPR .750-.789 AA	842
ER32 SRK 1/2X1.500	849
ER32 SRK 1/2X2.500	849
ER32 SRK 1/2X3.500	849
ER32 SRK 1/4X1.500	849
ER32 SRK 1/4X2.500	849
ER32 SRK 1/4X3.500	849
ER32 SRK 1/8X1.500	849
ER32 SRK 1/8X2.500	849
ER32 SRK 1/8X3.500	849
ER32 SRK 10X35	850
ER32 SRK 10X60	850
ER32 SRK 10X85	850
ER32 SRK 12X35	850
ER32 SRK 12X60	850
ER32 SRK 12X85	850
ER32 SRK 3/16X1.500	849
ER32 SRK 3/16X2.500	849
ER32 SRK 3/16X3.500	849
ER32 SRK 3/8X1.500	849
ER32 SRK 3/8X2.500	849

Designation	Page
ER32 SRK 3/8X3.500	849
ER32 SRK 3X35	850
ER32 SRK 3X60	850
ER32 SRK 3X85	850
ER32 SRK 4X35	850
ER32 SRK 4X60	850
ER32 SRK 4X85	850
ER32 SRK 5/16X1.500	849
ER32 SRK 5/16X2.500	849
ER32 SRK 5/16X3.500	849
ER32 SRK 5X35	850
ER32 SRK 5X60	850
ER32 SRK 5X85	850
ER32 SRK 6X35	850
ER32 SRK 6X60	850
ER32 SRK 6X85	850
ER32 SRK 7/16X1.500	849
ER32 SRK 7/16X2.500	849
ER32 SRK 7/16X3.500	849
ER32 SRK 8X35	850
ER32 SRK 8X60	850
ER32 SRK 8X85	850
ER32T05SA-10	425
ER32T05SA-20	425
ER32T06SA-10	425
ER32T06SA-20	425
ER32T08SA-10	425
ER32T08SA-20	425
ER32T10SA-10	425
ER32T10SA-20	425
ER32T12SA-10	425
ER32T12SA-20	425
ER32T15SA-10	425
ER32T15SA-20	425
ER-40	839
ER40 EX .250	841
ER40 EX .312	841
ER40 EX .375	841
ER40 EX .500	841
ER40 EX .625	841
ER40 EX .750	841
ER40 EX .875	841
ER40 EX 1.000	841
ER40 SEAL .120-.159	843
ER40 SEAL .120-.159 JET2	844
ER40 SEAL .159-.199	843
ER40 SEAL .159-.199 JET2	844
ER40 SEAL .199-.238	843
ER40 SEAL .199-.238 JET2	844
ER40 SEAL .238-.278	843
ER40 SEAL .238-.278 JET2	844
ER40 SEAL .278-.317	843
ER40 SEAL .278-.317 JET2	844
ER40 SEAL .317-.356	843
ER40 SEAL .317-.356 JET2	844
ER40 SEAL .356-.396	843
ER40 SEAL .356-.396 JET2	844
ER40 SEAL .396-.435	843
ER40 SEAL .396-.435 JET2	844
ER40 SEAL .435-.474	843
ER40 SEAL .435-.474 JET2	844
ER40 SEAL .474-.514	843
ER40 SEAL .474-.514 JET2	844
ER40 SEAL .514-.553	843
ER40 SEAL .514-.553 JET2	844
ER40 SEAL .553-.593	843
ER40 SEAL .553-.593 JET2	844
ER40 SEAL .593-.632	843
ER40 SEAL .593-.632 JET2	844
ER40 SEAL .632-.671	843
ER40 SEAL .632-.671 JET2	844
ER40 SEAL .671-.711	843
ER40 SEAL .671-.711 JET2	844
ER40 SEAL .711-.750	843
ER40 SEAL .711-.750 JET2	844
ER40 SEAL .750-.789	843
ER40 SEAL .750-.789 JET2	844

INDEX

Designation	Page
ER40 SEAL .789-.829	843
ER40 SEAL .789-.829 JET2	844
ER40 SEAL .829-.868	843
ER40 SEAL .829-.868 JET2	844
ER40 SEAL .868-.907	843
ER40 SEAL .868-.907 JET2	844
ER40 SEAL .907-.947	843
ER40 SEAL .907-.947 JET2	844
ER40 SEAL .947-.986	843
ER40 SEAL .947-.986 JET2	844
ER40 SEAL .986-1.025	843
ER40 SEAL .986-1.025 JET2	844
ER40 SPR .120-.159	841
ER40 SPR .120-.159 AA	842
ER40 SPR .159-.199	841
ER40 SPR .159-.199 AA	842
ER40 SPR .199-.238	841
ER40 SPR .199-.238 AA	842
ER40 SPR .238-.278	841
ER40 SPR .238-.278 AA	842
ER40 SPR .278-.317	841
ER40 SPR .278-.317 AA	842
ER40 SPR .317-.356	841
ER40 SPR .317-.356 AA	842
ER40 SPR .356-.396	841
ER40 SPR .356-.396 AA	842
ER40 SPR .396-.435	841
ER40 SPR .396-.435 AA	842
ER40 SPR .435-.474	841
ER40 SPR .435-.474 AA	842
ER40 SPR .474-.514	841
ER40 SPR .474-.514 AA	842
ER40 SPR .514-.553	841
ER40 SPR .514-.553 AA	842
ER40 SPR .553-.593	841
ER40 SPR .553-.593 AA	842
ER40 SPR .593-.632	841
ER40 SPR .593-.632 AA	842
ER40 SPR .632-.671	841
ER40 SPR .632-.671 AA	842
ER40 SPR .671-.711	841
ER40 SPR .671-.711 AA	842
ER40 SPR .711-.750	841
ER40 SPR .711-.750 AA	842
ER40 SPR .750-.789	842
ER40 SPR .750-.789 AA	842
ER40 SPR .789-.829	841
ER40 SPR .789-.829 AA	842
ER40 SPR .829-.868	841
ER40 SPR .829-.868 AA	842
ER40 SPR .868-.907	841
ER40 SPR .868-.907 AA	842
ER40 SPR .907-.947	841
ER40 SPR .907-.947 AA	842
ER40 SPR .947-.986	841
ER40 SPR .947-.986 AA	842
ER40 SPR .986-1.025	841
ER40 SPR .986-1.025 AA	842
ER-50	839
ER50 SPR .396-.474	841
ER50 SPR .474-.553	841
ER50 SPR .553-.632	841
ER50 SPR .632-.711	841
ER50 SPR .711-.789	841
ER50 SPR .789-.868	841
ER50 SPR .868-.947	841
ER50 SPR .947-1.025	841
ER50 SPR 1.025-1.102	841
ER50 SPR 1.102-1.181	841
ER50 SPR 1.181-1.260	841
ER50 SPR 1.260-1.338	841
FAK-0611884K01	492
FAK-0611884R01	491
FAK-0708284K01	492
FAK-0708284R01	490
FAK-0713584K01	492
FAK-0713584R01	491
FAK-0714484K01	492

Designation	Page
FAK-0714484R01	491
FAK-0809084K01	492
FAK-0809084R01	490
FEEW250340R-CR	232
FEEW250348R-CR	232
FEEW250350R-CR	232
FEEW250360R-CR	232
FEEW250364R-CR	232
FHM3X0.5X1	1042
FHM3X0.5X10	1042
FHM5X0.8X13-84A	1341
FL-0002	206
FL-0003	206
FL-0004	206
FL-0004	206
GEKT12T3AFTR-WC	182
GOMTO	504
GOMTO6	504
GOMTO60230R	505
GOMTO60245R	505
GOMTO60260R	505
GOMTO60345R	505
GOMTO60360R	505
GOMTO8	504
GOMTO80330R	505
GOMTO80345R	505
GOMTO80360R	505
GPHG091208R01	286
GPHG121708R01	286
GPHG121716R01	286
GPHG121732R01	286
GPHG152208R01	286
GPHG152216R01	286
GPHG152232R01	286
GPHG192508R01	286
GPHG192516R01	286
GPHG192532R01	286
GPHG252608R01	286
GPHG252616R01	286
GPHG252632R01	286
GTI ER11 ST5/8	834
GTI ER16 ST3/4	834
GTI ER20 ST3/4	834
GTI ER25 ST1	834
GTI ER32 ST1	834
GTI ER40 ST1-1/4	834
GTIN ER32 ANSI .141X.110	855
GTIN ER32 ANSI .168X.131	855
GTIN ER32 ANSI .194X.152	855
GTIN ER32 ANSI .220X.165	855
GTIN ER32 ANSI .255X.191	855
GTIN ER32 ANSI .318X.238	855
GTIN ER32 ANSI .323X.242	855
GTIN ER32 ANSI .367X.275	855
GTIN ER32 ANSI .381X.286	855
GTIN ER32 ANSI .429X.322	855
GTIN ER32 ANSI .480X.360	855
GTIN ER32 DIN 10.00X8.00	856
GTIN ER32 DIN 11.00X9.00	856
GTIN ER32 DIN 12.00X9.00	856
GTIN ER32 DIN 2.50X2.10	856
GTIN ER32 DIN 2.80X2.10	856
GTIN ER32 DIN 3.50X2.70	856
GTIN ER32 DIN 4.00X3.00	856
GTIN ER32 DIN 4.50X3.40	856
GTIN ER32 DIN 6.00X4.90	856
GTIN ER32 DIN 7.00X5.50	856
GTIN ER32 DIN 8.00X6.20	856
GTIN ER32 DIN 9.00X7.00	856
GTIN ER32 ISO 10.0X8.00	856
GTIN ER32 ISO 11.20X9.00	856
GTIN ER32 ISO 12.5X10.0	856
GTIN ER32 ISO 2.24X1.80	856
GTIN ER32 ISO 2.50X2.00	856
GTIN ER32 ISO 2.80X2.24	856
GTIN ER32 ISO 3.15X2.50	856
GTIN ER32 ISO 3.55X2.80	856

Designation	Page
GTIN ER32 ISO 4.00X3.15	856
GTIN ER32 ISO 4.50X3.55	856
GTIN ER32 ISO 5.00X4.00	856
GTIN ER32 ISO 5.60X4.50	856
GTIN ER32 ISO 6.30X5.00	856
GTIN ER32 ISO 7.10X5.60	856
GTIN ER32 ISO 8.00X6.30	856
GTIN ER32 ISO 9.00X7.10	856
GTIN ER32 JIS 10.5X8.0	856
GTIN ER32 JIS 12.5X10.0	856
GTIN ER32 JIS 3.0X2.5	856
GTIN ER32 JIS 4.0X3.2	856
GTIN ER32 JIS 5.0X4.0	856
GTIN ER32 JIS 5.5X4.5	856
GTIN ER32 JIS 6.0X4.5	856
GTIN ER32 JIS 6.2X5.0	856
GTIN ER32 JIS 7.0X5.5	856
GTIN ER32 JIS 8.5X6.5	856
H1.27	612
H1.5	595
H2	595
H2.5	595
H3	595
H4	595
H8	612
HC12	1044
HC7	1115
HC9	1044
HN_43_	1092
HN_64_	1092
HNGX050712CH	998
HNGX050716CH	998
HNGX453T7-CH	998
HNGX454T7-CH	998
HNMG050408SU	920
HNMG100612SU	920
HNMG432SU	920
HNMG643SU	920
HSK A 100 B16MN 100	773
HSK A 100 B16MN 200	773
HSK A 100 ER16X100	749
HSK A 100 ER16X100 M	748
HSK A 100 ER16X160	749
HSK A 100 ER16X160 M	748
HSK A 100 ER20X100	749
HSK A 100 ER20X100 M	748
HSK A 100 ER20X160	749
HSK A 100 ER20X160 M	748
HSK A 100 ER25X100	750
HSK A 100 ER25X120	750
HSK A 100 ER25X160	750
HSK A 100 ER32X100	750
HSK A 100 ER32X120	750
HSK A 100 ER32X160	750
HSK A 100 ER40X100	750
HSK A 100 ER40X120	750
HSK A 100 ER40X160	750
HSK A 100 ER50X100	750
HSK A 100 FM 60X70	768
HSK A 100 MT1X110	771
HSK A 100 MT2X120	771
HSK A 100 MT3X150	771
HSK A 100 MT4X170	771
HSK A 100 MT5X200	771
HSK A 100 SEM 22X 5	767
HSK A 100 SEM 27X 50	767
HSK A 100 SEM 32X 50	767
HSK A 100 SEM 40X 60	767
HSK A 100 SEM 50X 70	767
HSK A 100 SRKIN 6X 85	756
HSK A 100 SRKIN 6X120	756
HSK A 100 SRKIN 6X160	756
HSK A 100 SRKIN 8X 85	756
HSK A 100 SRKIN 8X120	756
HSK A 100 SRKIN 8X160	756
HSK A 100 SRKIN 1/2X3.750	754
HSK A 100 SRKIN 1/2X5.000	754

Designation	Page
HSK A 100 SRKIN 1/2X6.250	754
HSK A 100 SRKIN 1/4X3.500	754
HSK A 100 SRKIN 1/4X4.750	754
HSK A 100 SRKIN 1/4X6.250	754
HSK A 100 SRKIN 10X 90	756
HSK A 100 SRKIN 10X120	756
HSK A 100 SRKIN 10X160	756
HSK A 100 SRKIN 12X 95	756
HSK A 100 SRKIN 12X120	756
HSK A 100 SRKIN 12X160	756
HSK A 100 SRKIN 14X 95	756
HSK A 100 SRKIN 14X120	756
HSK A 100 SRKIN 14X160	756
HSK A 100 SRKIN 16X100	756
HSK A 100 SRKIN 16X120	756
HSK A 100 SRKIN 16X160	756
HSK A 100 SRKIN 18X100	756
HSK A 100 SRKIN 18X160	756
HSK A 100 SRKIN 1X4.500	754
HSK A 100 SRKIN 20X105	756
HSK A 100 SRKIN 20X160	756
HSK A 100 SRKIN 25X115	756
HSK A 100 SRKIN 3/4X4.125	754
HSK A 100 SRKIN 3/4X6.250	754
HSK A 100 SRKIN 3/8X3.625	754
HSK A 100 SRKIN 3/8X4.750	754
HSK A 100 SRKIN 3/8X6.250	754
HSK A 100 SRKIN 32X120	756
HSK A 100 SRKIN 5/8X4.000	754
HSK A 100 SRKIN 5/8X5.000	754
HSK A 100 SRKIN 5/8X6.250	754
HSK A 100 SRKIN 7/8X4.125	754
HSK A 100 SRKIN 7/8X6.250	754
HSK A 100 SRKIN1-1/4X4.75	754
HSK A 100 SRKIN5/16X3.500	754
HSK A 100 SRKIN5/16X4.750	754
HSK A 100 SRKIN5/16X6.250	754
HSK A 100 SRKIN7/16X3.750	754
HSK A 100 SRKIN7/16X4.750	754
HSK A 100 SRKIN7/16X6.250	754
HSK A 40 ER16X100	749
HSK A 40 ER16X60	749
HSK A 40 ER16X80	749
HSK A 40 ER25X100	750
HSK A 40 ER25X60	750
HSK A 40 ER25X80	750
HSK A 40 ER32X100	750
HSK A 40 SEM 22	767
HSK A 40 SEM 27	767
HSK A 50 B16MN 100	773
HSK A 50 B16MN 200	773
HSK A 50 EM1 X4.250	753
HSK A 50 EM1/2 X3.125	753
HSK A 50 EM1/4 X2.562	753
HSK A 50 EM3/16 X2.562	753
HSK A 50 EM3/4 X3.125	753
HSK A 50 EM3/8 X2.562	753
HSK A 50 EM5/8 X3.125	753
HSK A 50 EM7/8 X4.000	753
HSK A 50 ER16X100	749
HSK A 50 ER16X100 M	748
HSK A 50 ER16X120	749
HSK A 50 ER16X120 M	748
HSK A 50 ER20X100	749
HSK A 50 ER20X100 M	748
HSK A 50 ER20X120	749
HSK A 50 ER20X120 M	748
HSK A 50 ER25X100	750
HSK A 50 ER25X80	750
HSK A 50 ER32X100	750
HSK A 50 ER32X120	750
HSK A 50 MT1X100	771
HSK A 50 MT2X120	771
HSK A 50 MT3X140	771
HSK A 50 SEM 16X 50	767
HSK A 50 SEM 22X 60	767
HSK A 50 SEM 27X 60	767

Designation	Page
HSK A 63 B16MN 100	773
HSK A 63 B16MN 200	773
HSK A 63 EM1 X4.250	753
HSK A 63 EM1/2 X3.125	753
HSK A 63 EM1/4 X2.562	753
HSK A 63 EM1-1/4X4.250	753
HSK A 63 EM3/16 X2.562	753
HSK A 63 EM3/4 X3.150	753
HSK A 63 EM3/8 X2.562	753
HSK A 63 EM5/8 X3.125	753
HSK A 63 EM7/8 X4.000	753
HSK A 63 ER16X100	749
HSK A 63 ER16X100 M	748
HSK A 63 ER16X120	749
HSK A 63 ER16X120 M	748
HSK A 63 ER16X160	749
HSK A 63 ER16X160 M	748
HSK A 63 ER20X100	749
HSK A 63 ER20X100 M	748
HSK A 63 ER20X120	749
HSK A 63 ER20X120 M	748
HSK A 63 ER20X160	749
HSK A 63 ER20X160 M	748
HSK A 63 ER25X100	750
HSK A 63 ER25X120	750
HSK A 63 ER25X160	750
HSK A 63 ER25X80	750
HSK A 63 ER32X100	750
HSK A 63 ER32X120	750
HSK A 63 ER32X140	750
HSK A 63 ER32X160	750
HSK A 63 ER32X80	750
HSK A 63 ER40X100	750
HSK A 63 ER40X120	750
HSK A 63 ER40X80	750
HSK A 63 MT1X110	771
HSK A 63 MT2X120	771
HSK A 63 MT3X140	771
HSK A 63 MT4X160	771
HSK A 63 SEM 16X 50	767
HSK A 63 SEM 22X 50	767
HSK A 63 SEM 27X 60	767
HSK A 63 SEM 32X 60	767
HSK A 63 SEM 40X 60	767
HSK A 63 SRK 3X 50	762
HSK A 63 SRK 3X 85	762
HSK A 63 SRK 4X 50	762
HSK A 63 SRK 4X 85	762
HSK A 63 SRK 5X 50	762
HSK A 63 SRK 5X 85	762
HSK A 63 SRK 6X 50	762
HSK A 63 SRK 6X 85	762
HSK A 63 SRK 8X 50	762
HSK A 63 SRK 8X 85	762
HSK A 63 SRK 10X 50	762
HSK A 63 SRK 10X 85	762
HSK A 63 SRK 12X 50	762
HSK A 63 SRK 12X 85	762
HSK A 63 SRK1/2 X2.000	761
HSK A 63 SRK1/2 X3.250	761
HSK A 63 SRK1/4 X2.000	761
HSK A 63 SRK1/4 X3.250	761
HSK A 63 SRK1/8 X2.000	761
HSK A 63 SRK1/8 X3.250	761
HSK A 63 SRK3/16X2.000	761
HSK A 63 SRK3/16X3.250	761
HSK A 63 SRK3/8 X2.000	761
HSK A 63 SRK3/8 X3.250	761
HSK A 63 SRK5/16X2.000	761
HSK A 63 SRK5/16X3.250	761
HSK A 63 SRK7/16X2.000	761
HSK A 63 SRK7/16X3.250	761
HSK A 63 SRKIN 6X 80	755
HSK A 63 SRKIN 6X120	755
HSK A 63 SRKIN 6X160	755
HSK A 63 SRKIN 8X 80	755
HSK A 63 SRKIN 8X120	755

Designation	Page
HSK A 63 SRKIN 8X160	755
HSK A 63 SRKIN 1/2X3.543	754
HSK A 63 SRKIN 1/4X3.150	754
HSK A 63 SRKIN 10X 85	755
HSK A 63 SRKIN 10X120	755
HSK A 63 SRKIN 10X160	755
HSK A 63 SRKIN 12X 90	755
HSK A 63 SRKIN 12X120	755
HSK A 63 SRKIN 12X160	755
HSK A 63 SRKIN 14X 90	755
HSK A 63 SRKIN 14X120	755
HSK A 63 SRKIN 14X160	755
HSK A 63 SRKIN 16X 95	755
HSK A 63 SRKIN 16X120	755
HSK A 63 SRKIN 16X160	755
HSK A 63 SRKIN 18X 95	755
HSK A 63 SRKIN 18X120	755
HSK A 63 SRKIN 18X160	755
HSK A 63 SRKIN 20X100	755
HSK A 63 SRKIN 20X120	755
HSK A 63 SRKIN 20X160	755
HSK A 63 SRKIN 25X115	755
HSK A 63 SRKIN 3/4X3.937	754
HSK A 63 SRKIN 3/8X3.346	754
HSK A 63 SRKIN 32X120	755
HSK A 63 SRKIN 5/8X3.740	754
HSK A 63 SRKIN 7/8X3.937	754
HSK A 63 SRKIN1 X4.528	754
HSK A 63 SRKIN1-1/4X4.72	754
HSK A 63 SRKIN5/16X3.150	754
HSK A 63 SRKIN7/16X3.543	754
HSK A100 EM1 X4.000	753
HSK A100 EM1/2 X3.125	753
HSK A100 EM1/4 X3.125	753
HSK A100 EM1-1/2X4.000	753
HSK A100 EM1-1/4X4.000	753
HSK A100 EM3/16 X3.125	753
HSK A100 EM3/4 X4.000	753
HSK A100 EM3/8 X3.125	753
HSK A100 EM5/8 X4.000	753
HSK A100 EM7/8 X4.000	753
HSK A100 FM2-1/2x2.875	765
HSK A100 SEM1 X2.375	764
HSK A100 SEM1-1/2 X1.875	764
HSK A100 SEM1-1/4 X1.875	764
HSK A100 SEM2 X2.375	764
HSK A100 SEM3/4 X3.000	764
HSK A50 SEM1 X2.500	764
HSK A50 SEM1-1/4 X3.000	764
HSK A50 SEM3/4 X2.375	764
HSK A63 SEM1 X1.750	764
HSK A63 SEM1-1/2 X2.375	764
HSK A63 SEM1-1/4 X2.375	764
HSK A63 SEM2 X2.375	764
HSK A63 SEM3/4 X2.375	764
HSK E 32 SEM 16x50	766
HSK E 32 SEM 22x50	766
HSK E 32 SEM3/4 X2.000	763
HSK E 32 SRK1/2X2.000	759
HSK E 32 SRK1/4X2.000	759
HSK E 32 SRK1/8X2.000	759
HSK E 32 SRK3/16X2.000	759
HSK E 32 SRK3/8X2.000	759
HSK E 32 SRK5/16X2.000	759
HSK E 40 SEM 16x50	766
HSK E 40 SEM 22x50	766
HSK E 40 SEM3/4 X2.000	763
HSK E 50 SEM 22X 60	766
HSK E 50 SEM3/4 X2.375	763
HSK E 63 SEM 1 X2.375	763
HSK E 63 SEM 16X 50	766
HSK E 63 SEM 22X 50	766
HSK E 63 SEM3/4 X2.375	763
HSK E 32 ER16 X 60	747
HSK E 32 ER20 X 60	747
HSK E 32 ER25 X 65	747
HSK E 32 SRK 10X 45	760

INDEX

Designation	Page
HSK E 32 SRK 12X 45	760
HSK E 32 SRK 3X 45	760
HSK E 32 SRK 4X 45	760
HSK E 32 SRK 5X 45	760
HSK E 32 SRK 6X 45	760
HSK E 32 SRK 8X 45	760
HSK E 40 ER16 X 60	747
HSK E 40 ER16 X 80	747
HSK E 40 ER20 X 80	747
HSK E 40 ER25 X 80	747
HSK E 40 ER32 X 80	747
HSK E 40 SRK 3X 45	760
HSK E 40 SRK 3X 80	760
HSK E 40 SRK 4X 45	760
HSK E 40 SRK 4X 80	760
HSK E 40 SRK 5X 45	760
HSK E 40 SRK 5X 80	760
HSK E 40 SRK 6X 45	760
HSK E 40 SRK 6X 80	760
HSK E 40 SRK 8X 45	760
HSK E 40 SRK 8X 80	760
HSK E 40 SRK 10X 45	760
HSK E 40 SRK 10X 80	760
HSK E 40 SRK 12X 45	760
HSK E 40 SRK 12X 80	760
HSK E 40 SRK1/2 X1.750	759
HSK E 40 SRK1/2 X3.000	759
HSK E 40 SRK1/4 X1.750	759
HSK E 40 SRK1/4 X3.000	759
HSK E 40 SRK1/8 X1.750	759
HSK E 40 SRK1/8 X3.000	759
HSK E 40 SRK3/16X1.750	759
HSK E 40 SRK3/16X3.000	759
HSK E 40 SRK3/8 X1.750	759
HSK E 40 SRK3/8 X3.000	759
HSK E 40 SRK5/16X1.750	759
HSK E 40 SRK5/16X3.000	759
HSK E 40 SRK7/16X1.750	759
HSK E 40 SRK7/16X3.000	759
HSK E 50 ER16 X 100	747
HSK E 50 ER16 X 100M	747
HSK E 50 ER16 X 80	747
HSK E 50 ER20 X 80	747
HSK E 50 ER25 X 80	747
HSK E 50 ER32 X 100	747
HSK E 50 ER32 X 80	747
HSK E 50 SRK 3X 45	760
HSK E 50 SRK 3X 80	760
HSK E 50 SRK 4X 45	760
HSK E 50 SRK 4X 80	760
HSK E 50 SRK 5X 45	760
HSK E 50 SRK 5X 80	760
HSK E 50 SRK 6X 45	760
HSK E 50 SRK 6X 80	760
HSK E 50 SRK 8X 45	760
HSK E 50 SRK 8X 80	760
HSK E 50 SRK 10X 45	760
HSK E 50 SRK 10X 80	760
HSK E 50 SRK 12X 45	760
HSK E 50 SRK 12X 80	760
HSK E 50 SRK1/2 X1.750	759
HSK E 50 SRK1/2 X3.000	759
HSK E 50 SRK1/4 X1.750	759
HSK E 50 SRK1/4 X3.000	759
HSK E 50 SRK1/8 X1.750	759
HSK E 50 SRK1/8 X3.000	759
HSK E 50 SRK3/16X1.750	759
HSK E 50 SRK3/16X3.000	759
HSK E 50 SRK3/8 X1.750	759
HSK E 50 SRK3/8 X3.000	759
HSK E 50 SRK5/16X1.750	759
HSK E 50 SRK5/16X3.000	759
HSK E 50 SRK7/16X1.750	759
HSK E 50 SRK7/16X3.000	759
HSK E 63 ER16 X 100	747
HSK E 63 ER16 X 80	747
HSK E 63 ER32 X 100	747

Designation	Page
HSK E 63 ER32 X 80	747
HSK E 63 SRK 3X 45	760
HSK E 63 SRK 3X 80	760
HSK E 63 SRK 4X 45	760
HSK E 63 SRK 4X 80	760
HSK E 63 SRK 5X 45	760
HSK E 63 SRK 5X 80	760
HSK E 63 SRK 6X 45	760
HSK E 63 SRK 6X 80	760
HSK E 63 SRK 8X 45	760
HSK E 63 SRK 8X 80	760
HSK E 63 SRK 10X 45	760
HSK E 63 SRK 10X 80	760
HSK E 63 SRK 12X 45	760
HSK E 63 SRK 12X 80	760
HSK E 63 SRK 12X 90	760
HSK E 63 SRK1/2 X1.750	759
HSK E 63 SRK1/2 X3.000	759
HSK E 63 SRK1/4 X1.750	759
HSK E 63 SRK1/4 X3.000	759
HSK E 63 SRK1/8 X1.750	759
HSK E 63 SRK1/8 X3.000	759
HSK E 63 SRK3/16X1.750	759
HSK E 63 SRK3/16X3.000	759
HSK E 63 SRK3/8 X1.750	759
HSK E 63 SRK3/8 X3.000	759
HSK E 63 SRK5/16X1.750	759
HSK E 63 SRK5/16X3.000	759
HSK E 63 SRK7/16X1.750	759
HSK E 63 SRK7/16X3.000	759
HSK FM 63 ER16x100	751
HSK FM 63 ER16x120	751
HSK FM 63 ER16x160	751
HSK FM 63 ER16x80	751
HSK FM 63 SEM 1x2.375	769
HSK FM 63 SEM 22x60	770
HSK FM 63 SEM 27x60	770
HSK FM 63 SEM 3/4x3.00	769
HSK FM 63 SEM 3/4x4.50	769
HSK FM 63 SEM 32x60	770
HSK FM 63 SRKIN 1/2x3.50	757
HSK FM 63 SRKIN 1/4x3.13	757
HSK FM 63 SRKIN 10x85	758
HSK FM 63 SRKIN 12x90	758
HSK FM 63 SRKIN 14x90	758
HSK FM 63 SRKIN 16x95	758
HSK FM 63 SRKIN 18x95	758
HSK FM 63 SRKIN 1x3.00	757
HSK FM 63 SRKIN 1x4.00	757
HSK FM 63 SRKIN 20x100	758
HSK FM 63 SRKIN 25x115	758
HSK FM 63 SRKIN 3/4x3.00	757
HSK FM 63 SRKIN 3/4x3.75	757
HSK FM 63 SRKIN 3/8x3.50	757
HSK FM 63 SRKIN 32x120	758
HSK FM 63 SRKIN 5/16x3.13	757
HSK FM 63 SRKIN 5/8x3.50	757
HSK FM 63 SRKIN 6x80	758
HSK FM 63 SRKIN 8x80	758
HSK FM 63ER32x100	752
HSK FM 63ER32x80	752
HSK FM 63ER40x100	752
HSK FM 63ER40x80	752
HSKA100ER32SHORT	772
HSKA100ER40SHORT	772
HSKA63ER32SHORT	772
HSKA63MOD08SK059-G2	733
HSKA63MOD08SK084-G2	733
HSKA63MOD08SK109-G2	733
HSKA63MOD08SK134-G2	733
HSKA63MOD08SK184-G2	733
HSKA63MOD10SK059-G2	733
HSKA63MOD10SK084-G2	733
HSKA63MOD10SK109-G2	733
HSKA63MOD10SK134-G2	733
HSKA63MOD10SK184-G2	733
HSKA63MOD12SK059-G2	733

Designation	Page
HSKA63MOD12SK084-G2	733
HSKA63MOD12SK109-G2	733
HSKA63MOD12SK134-G2	733
HSKA63MOD12SK184-G2	733
HSKA63MOD16SK059-G2	733
HSKA63MOD16SK084-G2	733
HSKA63MOD16SK109-G2	733
HSKA63MOD16SK134-G2	733
HSKA63MOD16SK184-G2	733
HSKA63Z4SA062	726
ICSN433	1117
ICSN533	1117
ICSN633	1117
IDSN322	1050
IDSN433	1050
IND 32 TOOL ADAPTER	852
IND 40 TOOL ADAPTER	852
IND 50 TOOL ADAPTER	852
IND COOLING COLLET 10-12	852
IND COOLING COLLET 14-16	852
IND COOLING COLLET 18-20	852
IND COOLING COLLET 6-8	852
IND COOLING COLLET ER 10	852
IND COOLING COLLET ER 12	852
IND COOLING COLLET ER 3-5	852
IND COOLING COLLET ER 6	852
IND COOLING COLLET ER 8	852
IOR 18	663
IOR 19.5	663
IOR 21.5	663
IOR 23.5	663
IOR 26	663
IOR 28	663
IOR 30.5	663
IOR 33	663
IOR 35.5	663
IOR 39	663
IOR 42.5	663
IOR 46.5	663
IOR 51	663
IOR 55.5	663
IRSIN43	1052
IS12	559
IS14	561
IS21	563
IS23	578
IS30	565
IS32	579
IS40	567
IS45	580
IS63	581
ISSN322	1053
ISSN433	1055
ISSN533	1053
ISSN633	1053
ITSN322	1056
ITSN433	1056
ITSN533	1057
ITSN636	1058
IVSN322	1121
IVSN433	1062
IWSN322	1063
IWSN432	1063
IWSN433	1063
KDCM-10	499
KDCM-11	499
KDCM-12	499
KDCM-12-A	493
KDCM-13	499
KDCM-14	499
KDCM-15	499
KDCM-16	499
KDCM-16-A	493
KDCM-17	499
KDCM-18	499
KDCM-19	499
KDCM-20	499

Designation	Page
KDCM-21	499
KDCM-22	499
KDCM-23	499
KDCM-24	499
KDCM-25	499
KDCM-8	499
KDCM-9	499
KIT SHRINKIN LV2 USA	854
KIT SHRINKIN M V2 USA	854
KIT SHRINKIN S V2 USA	854
KITTCAP08R-2.25D TT9030	1386
KITTCAP08R-2.25DIN TT9030	1386
KITTCAP10R-2.25D TT9030	1386
KITTCAP10R-2.25DIN TT9030	1386
KITTCAP12R-2.25D TT9030	1386
KITTCAP12R-2.25DIN TT9030	1386
KITTCAP14R-2.25D TT9030	1386
KITTCAP14R-2.25DIN TT9030	1386
KITTCAP16R-2.25D TT9030	1386
KITTCAP16R-2.25DIN TT9030	1386
KITTCAP20R-2.25D TT9030	1386
KITTCAP20R-2.25DIN TT9030	1386
KITTCAP25R-2.25DIN TT9030	1386
KITTCAP32R-2.25DIN TT9030	1386
KNUX160405L11	920
KNUX160405L12	921
KNUX160405R11	920
KNUX160405R12	921
KNUX160410L11	920
KNUX160410L12	921
KNUX160410R11	920
KNUX160410R12	921
KNUX333_L	1042
KNUX333_R	1042
KNUX3331L11	920
KNUX3331L12	921
KNUX3331R11	920
KNUX3331R12	921
KNUX3332L11	920
KNUX3332L12	921
KNUX3332R11	920
KNUX3332R12	921
KOMT050104R	509
KP48S	1042
KSP48	1042
KSP90	1042
L1806RH	611
LCL2B	1124
LCL3B	1123
LCL4B	1340
LCS2B	1123
LCS4B-T	1340
LS0902	647
LS0902.5-6	641
LS0903	647
LS0903-8	641
LS0904	647
LS0904-10	641
LS0905	648
LS0905-12	641
LS0906	649
LS0906-15	641
LS1206	595
LS1206S	594
LS1803.5RH	595
LS1803RH	595
LS1805RH	595
LS1806RH	595
LSC32	1087
LSC42	1137
LSC63	1087
LSD32	1090
LSD43	1138
LSR2B	1124
LSR3B	1123
LSR4B	1340
LSS63	1094

Designation	Page
LST32	1140
L-W2	1042
L-W2.5	1087
L-W3	250
L-W3.5	1129
L-W4	287
L-W5	530
L-W6	1318
LYER2708OUN	578
LYER27100IS	578
LYER27110BT	578
LYER27110BW	578
LYER27115NT	578
LYER27120UN	578
LYER27150IS	578
LYER27160UN	578
LYER27200IS	578
LYER27240UN	578
LYER27300IS	578
LYER32060UN	579
LYER32080UN	579
LYER32110BT	579
LYER32110BW	579
LYER32115NT	579
LYER32120UN	579
LYER32150IS	579
LYER32160UN	579
LYER32200IS	579
LYER32300IS	579
LYER32400IS	579
LYER37060UN	580
LYER37080UN	580
LYER37110BT	580
LYER37110BW	580
LYER37115NT	580
LYER37120UN	580
LYER37150IS	580
LYER37160UN	580
LYER37200IS	580
LYER37300IS	580
LYER37400IS	580
LYER38060UN	581
LYER38080UN	581
LYER38110BT	581
LYER38110BW	581
LYER38115NT	581
LYER38120UN	581
LYER38150IS	581
LYER38160UN	581
LYER38200IS	581
LYER38300IS	581
LYER38400IS	581
LYEU12050IS	559
LYEU12075IS	559
LYEU12100IS	559
LYEU12125IS	559
LYEU12150IS	559
LYEU12160UN	559
LYEU12180NF	559
LYEU12180NT	559
LYEU12180UN	559
LYEU12190BT	559
LYEU12190BW	559
LYEU12200UN	559
LYEU12240UN	559
LYEU12280UN	559
LYEU12320UN	559
LYEU14050IS	561
LYEU14075IS	561
LYEU14075IS-X	561
LYEU14100IS	561
LYEU14100IS-X	561
LYEU14100UN	561
LYEU14120UN	561
LYEU14120UN-X	561
LYEU14125IS	561
LYEU14125IS-X	561

Designation	Page
LYEU14140BT	561
LYEU14140BW	561
LYEU14140NF	561
LYEU14140NT	561
LYEU14140UN	561
LYEU14140UN-X	561
LYEU14150IS	561
LYEU14150IS-X	561
LYEU14160BW	561
LYEU14160UN	561
LYEU14160UN-X	561
LYEU14175IS	561
LYEU14175IS-X	561
LYEU14180NF	561
LYEU14180NT	561
LYEU14180UN	561
LYEU14180UN-X	561
LYEU14190BT	561
LYEU14190BW	561
LYEU14200BW	561
LYEU14200IS	561
LYEU14200IS-X	561
LYEU14200UN	561
LYEU14200UN-X	561
LYEU14240BW	561
LYEU14240UN	561
LYEU14240UN-X	561
LYEU14250IS	561
LYEU14250IS-X	561
LYEU14270UN	561
LYEU14280UN	561
LYEU14280UN-X	561
LYEU14320UN	561
LYEU14320UN-X	561
LYEU21070UN	563
LYEU21080UN	563
LYEU21100IS	563
LYEU21100IS-X	563
LYEU21100UN	563
LYEU21100UN-X	563
LYEU21110B	571
LYEU21110BT	563
LYEU21110BW	563
LYEU21115NF	563
LYEU21115NT	563
LYEU21120UN	563
LYEU21120UN-X	563
LYEU21140BT	563
LYEU21140BW	563
LYEU21140NF	563
LYEU21140NT	563
LYEU21140UN	563
LYEU21140UN-X	563
LYEU21150IS	563
LYEU21150IS-X	563
LYEU21160BW	563
LYEU21160UN	563
LYEU21160UN-X	563
LYEU21175IS	563
LYEU21180UN	563
LYEU21180UN-X	563
LYEU21190BW	563
LYEU21200BW	563
LYEU21200IS	563
LYEU21200IS-X	563
LYEU21200UN	563
LYEU21200UN-X	563
LYEU21240UN	563
LYEU21240UN-X	563
LYEU21250IS	563
LYEU21250IS-X	563
LYEU21300IS	563
LYEU21300IS-X	563
LYEU21350IS	563
LYEU30060UN	565
LYEU30060UN-X	565
LYEU30080NF	565

INDEX

Designation	Page
LYEU30080NT	565
LYEU30080UN	565
LYEU30080UN-X	565
LYEU30100UN	565
LYEU30100UN-X	565
LYEU30110BT	565
LYEU30110BW	565
LYEU30115NF	565
LYEU30115NT	565
LYEU30120UN	565
LYEU30120UN-X	565
LYEU30140BW	565
LYEU30140UN	565
LYEU30140UN-X	565
LYEU30150IS	565
LYEU30150IS-X	565
LYEU30160BW	565
LYEU30160UN	565
LYEU30160UN-X	565
LYEU30180UN	565
LYEU30180UN-X	565
LYEU30200IS	565
LYEU30200IS-X	565
LYEU30200UN	565
LYEU30200UN-X	565
LYEU30300IS	565
LYEU30300IS-X	565
LYEU30350IS	565
LYEU30350IS-X	565
LYEU30400IS	565
LYEU30400IS-X	565
LYEU30450IS	565
LYEU30500IS	565
LYEU40040UN	567
LYEU40045UN	567
LYEU40060UN	567
LYEU40060UN-X	567
LYEU40080BW	567
LYEU40080NF	567
LYEU40080NT	567
LYEU40080UN	567
LYEU40080UN-X	567
LYEU40100UN	567
LYEU40100UN-X	567
LYEU40110BT	567
LYEU40110BW	567
LYEU40115NF	567
LYEU40115NT	567
LYEU40120UN	567
LYEU40120UN-X	567
LYEU40140UN	567
LYEU40140UN-X	567
LYEU40150IS	567
LYEU40150IS-X	567
LYEU40160UN	567
LYEU40160UN-	577
LYEU40160UN-X	567
LYEU40200IS	567
LYEU40200IS-X	567
LYEU40300IS	567
LYEU40300IS-X	567
LYEU40350IS	567
LYEU40400IS	567
LYEU40400IS-X	567
LYEU40450IS	567
LYEU40500IS	567
LYEU40500IS-X	567
LYEU40550IS	567
LYEU40600IS	567
LYEU40600IS-X	567
M 10 CLAMP SCREW SEM 22	864
M 12 CLAMP SCREW SEM 27	864
M 16 CLAMP SCREW SEM 32	864
M 20 CLAMP SCREW SEM 40	864
M 24 CLAMP SCREW SEM 50	864
M 8 CLAMP SCREW SEM 16	864
M5X20DIN912	1335

Designation	Page
M5X25DIN912	1335
MDJNL10-3B	1050
MDJNL24-4D	1050
MDJNR08-3A	1050
MDJNR10-3B	1050
MDJNR24-4D	1050
MDJNR85-4D	1050
MDQNL12-4B	1051
MDQNL20-4D	1051
MDQNR12-4B	1051
MDQNR20-4D	1051
MHK018047DBR01	504
MHK019047DBR01	504
MHK024067DBR01	504
MHK025067DBR01	504
MHK026067DBR01	504
MHK027067DBR01	504
MHK028067DCR01	504
MHK029067DCR01	504
MHK030067DCR01	504
MHK031067DCR01	504
MHK032067DCR01	504
MHK033075DCR01	504
MHK034075DCR01	504
MOD08MOD06SK030	737
MOD08MOD08SA030	736
MOD10MOD08SK040	737
MOD10MOD10SA035	736
MOD12MOD10SK045	737
MOD12MOD12SA040	736
MOD16MOD12SK050	737
MOD16MOD16SA040	736
MRGNL12-4B	1052
MRGNL16-4D	1052
MRGNL20-4D	1052
MRGNR12-4B	1052
MRGNR16-4D	1052
MRGNR20-4D	1052
MSDNN10-3B	1053
MSDNN12-3B	1053
MSDNN16-5D	1053
MSDNN20-5D	1053
MSDNN20-6E	1053
MSDNN24-6E	1053
MSDNN85-4D	1053
MSDNN85-5D	1053
MSDNN85-6D	1053
MSRNL12-3B	1054
MSRNL16-5D	1054
MSRNL24-6E	1054
MSRNR10-3B	1054
MSRNR12-3B	1054
MSRNR16-5D	1054
MSRNR24-6E	1054
MSSNL12-4B	1055
MSSNL20-5D	1055
MSSNR12-4B	1055
MSSNR20-5D	1055
MT2 ER20x1.909	835
MT2 ER25x2.008	835
MT3 ER32x2.717	835
MT3 ER40x3.150	835
MT4 ER32x2.382	835
MT4 ER40x3.193	835
MT4 ER50x4.232	835
MT5 ER40x3.445	835
MT5 ER50x3.346	835
MT6 ER50x3.465	835
MTCNN08-3B	1056
MTCNN12-4B	1056
MTCNN44-3F	1056
MTCNN64-4F	1056
MTCNN66-4F	1056
MTENN10-3B	1057
MTENN12-3B	1057
MTENN16-4D	1057
MTENN20-5E	1057

Designation	Page
MTENN85-4D	1057
MTFNL08-2A	1058
MTFNL10-3B	1058
MTFNL16-5D	1058
MTFNL20-4D	1058
MTFNL20-5D	1058
MTFNL24-5E	1058
MTFNL24-6E	1058
MTFNR08-2A	1058
MTFNR10-3B	1058
MTFNR16-5D	1058
MTFNR20-4D	1058
MTFNR20-5D	1058
MTFNR24-5E	1058
MTFNR24-6E	1058
MTGNL10-2B	1059
MTGNL10-3B	1059
MTGNL16-4D	1059
MTGNL20-4D	1059
MTGNL20-5D	1059
MTGNL24-5E	1059
MTGNL24-6E	1059
MTGNR10-2B	1059
MTGNR10-3B	1059
MTGNR16-4D	1059
MTGNR20-4D	1059
MTGNR20-5D	1059
MTGNR24-5E	1059
MTGNR24-6E	1059
MTJNL10-2B	1060
MTJNL10-3B	1060
MTJNL12-3B	1060
MTJNL16-3D	1060
MTJNL16-4D	1060
MTJNL16-5D	1060
MTJNL20-4D	1060
MTJNL20-5D	1060
MTJNL24-5E	1060
MTJNL24-6E	1060
MTJNR10-2B	1060
MTJNR10-3B	1060
MTJNR12-3B	1060
MTJNR16-3D	1060
MTJNR16-4D	1060
MTJNR16-5D	1060
MTJNR20-4D	1060
MTJNR20-5D	1060
MTJNR24-5E	1060
MTJNR24-6E	1060
MULTI CLAMP 100 A/C	868
MULTI CLAMP 40 E/F	869
MULTI CLAMP 50 A/C	868
MULTI CLAMP 50 E/F	869
MULTI CLAMP 63 A/C	868
MULTI CLAMP 63 E/F	869
MVJNL16-4D	1062
MVJNL20-4D	1062
MVJNR12-4B	1062
MVJNR16-4D	1062
MVJNR20-4D	1062
MWLNL12-3B	1063
MWLNL12-4B	1063
MWLNL16-3C	1063
MWLNL16-4D	1063
MWLNL20-4D	1063
MWLNR12-3B	1063
MWLNR12-4B	1063
MWLNR16-3C	1063
MWLNR16-4D	1063
MWLNR20-4D	1063
NCE324-100	153
NCE324R107	158
NCET25	292
NCET250400R	293
NDET38	292
NDET380700R	293
NDET50	292

Designation	Page
NDET500800R	293
NE04-80	193
NJE324-100-P	153
NKET12	292
NKET120200R	293
NKET18	292
NKET180300R	293
NL23	1058
NL33	1050
NL34	1053
NL34L	1056
NL44	1117
NL46	1050
NL58	1053
NL68	1053
NL68L	1058
NNE324	199
NNE324-100	153
NNE324-102	153
NNE324-104	153
NNE324-108	212
NNE324-110	192
NNE324-125	153
NNE324L109	153
NNE324R107	158
NNE324R109	153
NNE425-030	193
NNET31	292
NNET310500R	293
NPHG090300R	286
NPHG120400R	286
NPHG150400R	286
NPHG190400R	286
NPHG250600R	286
NPHG310700R	286
NPMT 05504R1	620
NPMT 06504L2	624
NPMT 06504R1	620
NPMT 06504R2	624
NPMT 07504R1	620
NPMT 0804L2	624
NPMT 0804R2	624
NPMT 09504L2	624
NPMT 09504R1	620
NPMT 09504R2	624
NPMT 12504L2	624
NPMT 12504R2	624
NPMT 13-TDMR	628
NPMT 19-TDMR	628
NPMX 0802RG	612
NPMX 0802xx	612
NPMX 0803RB	593
NPMX 0803RG	593
NPMX 0803xx	595
NPMX 1403xx	595
NPMX 1704xx	595
NPMX 2405xx	595
NPMX 2807xx	595
NPMX13-TDMR	629
NPMX19-TDMR	629
NUT ER11 MINI	860
NUT ER11 UM	860
NUT ER16 MINI	860
NUT ER16 TOP	860
NUT ER16 TOP MINI	860
NUT ER16 UM	860
NUT ER20 MINI	860
NUT ER20 SHORT	861
NUT ER20 TOP	860
NUT ER20 UM	860
NUT ER25 MINI	860
NUT ER25 TOP	860
NUT ER25 UM	860
NUT ER32 SHORT	861
NUT ER32 TOP	860
NUT ER32 UM	860
NUT ER40 SHORT	861

Designation	Page
NUT ER40 TOP	860
NUT ER40 UM	860
NUT ER50 UM	860
NZ104	1093
NZ125	1313
NZ62	1093
NZP5	1329
OELB060416FN	175
OELB060416N	175
OELH060416N	175
OELH060416-P	175
OFCT05T3AFFN-P	172
OFCT05T3TN	172
OFCT0705AFFN-P	173
OFCT0705AFFR-W	173
OFMT05T3AFN-HR	172
OFMT0705AFR-HR	173
OFMT0705AFN	173
OFMW0705AFN	173
ON5H-20R01	166
ON5H-30R01	166
ON5H-40R01	166
ON5H-60R01	166
ON6H-15R01	166
ON6H-20R01	166
ON6H-25R01	166
ON6H-30R01	166
ON6H-40R01	166
ON6H-50R01	166
ON6H-60R01	166
ONCU0505ANEN	167
ONCU0505ANFN-P	167
ONCU0505ANTN-HR	167
ONCU0505ANTN-W	167
ONCU090612FN-P	169
ONCU090612TN-HR	169
ONCU090612TN-W	169
ONCU0906ANFN-WE	169
OOR 65	663
OP1N-10L01	168
OP1N-10R01	168
OP1N-12L01	168
OP1N-12R01	168
OP1N-30R01	168
OP1N-40R01	168
OP1N-50R01	168
OP1N-60R01	168
OP1N-80L01	168
OP1N-80R01	168
OP6N-10R01	170
OP6N-12R01	170
OP6N-25R01	170
OP6N-30R01	170
OP6N-40R01	170
OP6N-50R01	170
OP6N-60R01	170
OP6N-80R01	170
OPEN050608TR	127
PA-0575	127
PAD-GC06-075	616
PAD-GC06-085	616
PAD-GC06-100	616
PAD-GC08	594
PAD-GC08-120	616
PAD-GC08-140	612
PAD-GC10	594
PAD-GC14	594
PAD-GC18	594
PAD-GC22	628
PAD-GO07	620
PAD-GO08	620
PAD-GO10	620
PAD-GO12	624
PAD-P06-075	616
PAD-P06-085	616
PAD-P06-100	616
PAD-P08	594

Designation	Page
PAD-P08-120	616
PAD-P08-140	612
PAD-P10	594
PAD-P14	594
PAD-P18	594
PAD-P22	628
PAD-R10	641
PAD-R12	641
PAD-R15	641
PAD-R20	641
PAD-R30	641
PAD-R35	641
PAD-S06	612
PAD-S08	594
PAD-S10	594
PAD-S14	594
PAL0636	89
PAR0628	149
PAR0629	151
PAR0636	89
PAR0646	145
PERC 05	596
PERC 05R	595
PERC 06R	612
PERC 402-04	595
PERC 402-32	595
PERC 402-43	595
PERC 402-63	595
PERC310-13QRA	629
PERC310-190QRA	632
PERC310-19QRA	629
PERC-402-04	642
PERC-402-32	642
PERC-402-43	642
PERC-P 04R	648
PERC-P 32R	648
PERC-P 43R	649
PERC-P04R	642
PERC-P32R	642
PERC-P43R	642
PF-0012	529
PF-0013	529
PL075	1129
PL100	1133
PL125	1133
PL150	1337
PL16	1327
PL20	1327
PL25	1327
PL-25	1337
PL32	1327
PL40	1327
PNCQ0804GNTN	177
PNCQ0804ZNTN	274
PNCT0804ZNN-HR	274
PNCU08	199
PNCU0805GNFR-HS	177
PNCU0805GNFR-P	177
PNCU0805GNR	177
PNCU0805GNTR	177
PNCU0805GNTR-W	177
PNCU1708GNTR	179
PRESET ER-JET 10X1.5	863
PRESET ER-JET 12X1.0	863
PRESET ER-JET 12X1.75	863
PRESET ER-JET 12X1.75L	863
PRESET ER-JET 14X1.0	863
PRESET ER-JET 16X2	863
PRESET ER-JET 16X2L	863
PRESET ER-JET 18X1.0	863
PRESET ER-JET 18X1.5	863
PRESET ER-JET 18X1.5L	863
PRESET ER-JET 22X1.5	863
PRESET ER-JET 22X1.5L	863
PRESET ER-JET 28X1.5	863
PRESET ER-JET 8X1.0	863
PRESET ER-JET 8X1.25	863

INDEX

Designation	Page	Designation	Page	Designation	Page
PRESET SCREW	863	Q0127038N5R01	520	Q0270108N6R01	522
PRESET SCREW M 5X20 B	866	Q0127051N5R01	522	Q0270135N6R01	524
PRESET SCREW M 6X20 B	866	Q0127064N5R01	524	Q0278056N6R02	518
PRESET SCREW M 8X20 B	866	Q0135027N5R01	518	Q0278083N6R02	520
PRESET SCREW M10X18 B	866	Q0135041N5R01	520	Q0278111N6R02	522
PRESET SCREW M12X18 B	866	Q0135054N5R01	522	Q0278143N6R02	524
PRESET SCREW M16X20 B	866	Q0135067N5R01	524	Q0286057N6R02	518
PRESET SCREW M16X25 B	866	Q0143029N5R01	518	Q0286086N6R02	520
PRESET SCREW M20X20 B	866	Q0143043N5R01	520	Q0286114N6R02	522
PRESET SCREW M20X25 B	866	Q0143057N5R01	522	Q0286143N6R02	524
PRESETTG100 1-1/8x16 L.H.	863	Q0143072N5R01	524	Q0294059N6R01	518
PS BT30 15° M12 JIS B	859	Q0150030N5R01	518	Q0294088N6R01	520
PS BT30 45° M12 MAS1	858	Q0150045N5R01	520	Q0294118N6R01	522
PS BT30 45° M12 MAS1 B	858	Q0150060N5R01	522	Q0294147N6R01	524
PS BT30 60° M12 MAS2	858	Q0150075N5R01	524	Q0302060N6R01	518
PS BT30 60° M12 MAS2 B	858	Q0159032N5R01	518	Q0302090N6R01	520
PS BT40 15° M16 JIS B	859	Q0159048N5R01	520	Q0302120N6R01	522
PS BT40 15° M16 JIS O B	859	Q0159064N5R01	522	Q0302151N6R01	524
PS BT40 15° M16 JIS O B O	859	Q0159080N5R01	524	Q0310062N6R01	518
PS BT40 45° M16 MAS1	858	Q0167033N5R01	518	Q0310093N6R01	520
PS BT40 45° M16 MAS1 B	858	Q0167050N5R01	520	Q0310124N6R01	522
PS BT40 45° M16 MAZAK B	859	Q0167067N5R01	522	Q0310155N6R01	524
PS BT40 60° M16 MAS2	858	Q0167083N5R01	524	Q0318063N6R01	518
PS BT40 60° M16 MAS2 B	858	Q0175035N5R01	518	Q0318095N6R01	520
PS BT40 90° M16 MAS3	858	Q0175053N5R01	520	Q0318127N6R01	522
PS BT40 90° M16 MAS3 B	858	Q0175070N5R01	522	Q0318159N6R01	524
PS BT50 15° M24 JIS B	859	Q0175087N5R01	524	Q0325065N6R01	518
PS BT50 15° M24 JIS O B	859	Q0183037N5R01	518	Q0325098N6R01	520
PS BT50 15° M24 JIS O B O	859	Q0183055N5R01	520	Q0325130N6R01	522
PS BT50 45° M24 MAS1	858	Q0183073N5R01	522	Q0325163N6R01	524
PS BT50 45° M24 MAS1 B	858	Q0183091N5R01	524	Q0333067N6R01	518
PS BT50 45° M24 MAS1 O B	858	Q0191038N5R01	518	Q0333100N6R01	520
PS BT50 45° M24 MAS1 O B O	858	Q0191057N5R01	520	Q0333133N6R01	522
PS BT50 45° M24 MAZAK B	859	Q0191076N5R01	522	Q0333167N6R01	524
PS BT50 60° M24 MAS2	858	Q0191095N5R01	524	Q0341068N6R02	518
PS BT50 60° M24 MAS2 B	858	Q0198040N5R01	518	Q0341102N6R02	520
PS BT50 60° M24 MAS2 O B	858	Q0198059N5R01	520	Q0341136N6R02	522
PS BT50 90° M24 MAS3	858	Q0198079N5R01	522	Q0341171N6R02	524
PS BT50 90° M24 MAS3 B	858	Q0198099N5R01	524	Q0349070N6R02	518
PS BT50 90° M24 MAS3 O B	858	Q0206041N5R01	518	Q0349105N6R02	520
PS CAT30 45° 1/2 ANSI	857	Q0206062N5R01	520	Q0349140N6R02	522
PS CAT30 45° M12 ISO B	859	Q0206082N5R01	522	Q0349175N6R01	524
PS CAT40 45° 5/8 ANSI	857	Q0206103N5R01	524	Q0357071N6R02	518
PS CAT40 45° 5/8 ANSI B	857	Q0214042N5R02	518	Q0357107N6R02	520
PS CAT40 45° 5/8 MAS1	857	Q0214064N5R02	520	Q0357143N6R02	522
PS CAT40 45° 5/8 MAS1 B	857	Q0214086N5R02	522	Q0357179N6R02	524
PS CAT40 45° M16 ISO B	859	Q0214107N5R01	524	Q0365073N6R01	518
PS CAT40 60° 5/8 MAS2	857	Q0222044N5R02	518	Q0365110N6R01	520
PS CAT40 60° 5/8 MAS2 B	857	Q0222067N5R02	520	Q0365146N6R01	522
PS CAT40 90° 5/8 MAS3	857	Q0222089N5R02	522	Q0365182N6R01	524
PS CAT40 90° 5/8MAS3 B	857	Q0222111N5R01	524	Q0373075N6R01	518
PS CAT50 45° 1 ANSI	857	Q0230046N6R01	518	Q0373112N6R01	520
PS CAT50 45° 1 ANSI B	857	Q0230069N6R01	520	Q0373149N6R01	522
PS CAT50 45° 1" MAS1	857	Q0230092N6R01	522	Q0373186N6R01	524
PS CAT50 45° 1" MAS1 B	857	Q0230115N6R01	524	Q0381076N6R01	518
PS CAT50 45° 1" MAS1 O B	857	Q0238048N6R01	518	Q0381114N6R01	520
PS CAT50 45° M24 ISO B	859	Q0238071N6R01	520	Q0381152N6R01	522
PS CAT50 60° 1" MAS2	857	Q0238095N6R01	522	Q0381191N6R01	524
PS CAT50 60° 1" MAS2 B	857	Q0238119N6R01	524	Q0389078N6R01	518
PS CAT50 90° 1" MAS3	857	Q0246049N6R01	518	Q0389117N6R01	520
PS CAT50 90° 1" MAS3 B	857	Q0246074N6R01	520	Q0389156N6R01	522
PS OTT BT40 M16	858	Q0246098N6R01	522	Q0389194N6R01	524
PS OTT BT50 M24	858	Q0246123N6R01	524	Q0397079N6R01	518
PS OTT SK40 M16	858	Q0250050N6R01	518	Q0397119N6R01	520
PS SK30 15° M12 DIN	859	Q0250075N6R01	520	Q0397159N6R01	522
PS SK40 15° M16 DIN	859	Q0250100N6R01	522	Q0405081N6R01	518
PS SK40 15° M16 DIN B	859	Q0250125N6R01	524	Q0405122N6R01	520
PS SK40 15° M16 DIN O	859	Q0254051N6R01	518	Q0405162N6R01	522
PS SK40 15° M16 DIN O B	859	Q0254076N6R01	520	Q0405202N6R01	524
PS SK50 15° M24 DIN	859	Q0254102N6R01	522	Q0413083N6R01	518
PS SK50 15° M24 DIN B	859	Q0254127N6R01	524	Q0413124N6R01	520
PS SK50 15° M24 DIN O	859	Q0262052N6R01	518	Q0413165N6R01	522
PSW32	1102	Q0262079N6R01	520	Q0413206N6R01	524
PSW42	1141	Q0262105N6R01	522	Q0428086N6R02	518
PZ-0499	96	Q0262131N6R01	524	Q0428128N6R02	520
PZ-0500	94	Q0270054N6R01	518	Q0428171N6R02	522
Q0127025N5R01	518	Q0270081N6R01	520	Q0437087N6R01	519

Designation	Page
Q0437131N6R01	521
Q0437175N6R01	523
Q0445089N6R01	519
Q0445134N6R01	521
Q0445178N6R01	523
Q0452090N7R01	519
Q0452136N7R01	521
Q0452181N7R01	523
Q0460092N7R01	519
Q0460138N7R01	521
Q0460184N7R01	523
Q0476095N7R01	519
Q0476143N7R01	521
Q0476190N7R01	523
Q0492098N7R01	519
Q0492148N7R01	521
Q0492197N7R01	523
Q0500100N7R01	519
Q0500150N7R01	521
Q0500200N7R01	523
Q0508102N7R01	519
Q0508152N7R01	521
Q0508203N7R01	523
Q0539108N8R01	525
Q0539162N8R01	526
Q0539216N8R01	527
Q0571114N8R01	525
Q0571172N8R01	526
Q0571229N8R01	527
Q0603121N8R01	525
Q0603181N8R01	526
Q0603241N8R01	527
Q0635127N8R01	525
Q0635191N8R01	526
Q0635254N8R01	527
Q0666133N8R01	525
Q0666200N8R01	526
Q0666267N8R01	527
Q0698140N8R01	525
Q0698210N8R01	526
Q0698279N8R02	527
Q0730146N8R01	525
Q0730219N8R01	526
Q0730292N8R01	527
Q0762152N8R01	525
Q0762229N8R01	526
Q0762305N8R01	527
Q0825165N8R01	525
Q0825248N8R01	526
Q0825330N8R01	527
QA0540111N8R01	530
QA0540167N8R01	531
QA0572121N8R01	530
QA0572181N8R01	531
QA0619130N8R01	530
QA0619195N8R01	531
QA0667143N8R01	530
QA0667214N8R01	531
QA0730159N8R01	530
QA0730238N8R01	531
QF0159048N5R01	534
QF0175053N5R0	534
QF0183055N5R01	534
QF0191057N5R01	534
QF0198059N5R01	534
QF0206062N5R01	534
QF0214064N5R01	534
QF0222067N5R01	534
QF0230069N6R01	534
QF0238071N6R01	534
QF0246074N6R01	534
QF0254076N6R01	534
QF0262079N6R01	534
QF0270081N6R01	534
QF0278083N6R01	534
QF0286086N6R01	534
QF0294088N6R01	534

Designation	Page
QF0302090N6R01	534
QF0310093N6R01	534
QF0318095N6R01	534
QF0325098N6R01	534
QF0333100N6R01	534
QF0341102N6R01	534
QF0349105N6R01	534
QF0365110N6R01	534
QF0373112N6R01	534
QF0381114N6R01	534
QF0389117N6R01	534
QF0397119N6R01	534
QF0413124N6R01	534
QF0428128N6R01	534
QF0437131N6R01	534
QF0445134N6R01	534
QF0476143N7R01	534
QF0492148N7R01	534
R20 SPR .474-.514 AA	842
R32 SPR .238-.278	841
R40 SPR .750-.789	841
RC_T10T300	1072
RC_T120400	1072
RCGT0803MOFL	991
RCGT1003MOFL	991
RCGT10T3MOFL	991
RCGX060300FT	1011
RCGX060600U1	999
RCGX090300FT	1011
RCGX090700U1	999
RCGX120400FT	1011
RCGX120700U2	999
RCGX151000U2	999
RCGX191000U2	999
RCGX22FT	1011
RCGX24U1	999
RCGX32FT	1011
RCGX35U1	999
RCGX43FT	1011
RCGX45U2	999
RCGX57U2	999
RCGX67U2	999
RCHX120400FN-P	245
RCKX120400TN-M	245
RCLB120500TN-VL	245
RCLB19	199
RCLB19T600TN-VL	253
RCLT12	278
RCLT1204MON-CC1	277
RCLT1204MON-CC2	277
RCLT1204MON-CP	277
RCLT1204MOTN-PH2	277
RCLT16	278
RCLT1606MON-CC	279
RCLT1606MON-CC1	279
RCLT1606MON-CC2	279
RCLT1606MON-CP	279
RCLT1606MOTN-PH	279
RCLT1606MOTN-PH2	279
RCLT190600N-HR	253
RCMT10T300MT	971
RCMT120400MT	971
RCMT160600MT	971
RCMX100300	972
RCMX120400	972
RCMX160600	972
RCMX200600	972
RCMX250700	972
RCMX320900	972
RFMT1404MON-F	172
RHHT1003MOFN-P	258
RHHT1204MOFN-P	258
RHHW0602MOTN	258
RHHW0802MOTN	258
RHHW1003MOTN	258
RHHW1204MOTN	258
RHHW1605MOTN	258

Designation	Page
RHKW1003MOTN	258
RHKW1204MOTN	258
RHKW1605MOTN	258
RHKW2006MOTN	261
RNG32	999
RNG43	999
RNG43E	999
RNG45	999
RNG45E	999
RNG45T6	999
RNG45W2	999
RNG55	999
RNG65	999
RNGN 090300	999
RNGN 120700	999
RNGN120400	999
RNGN120400E	999
RNGN120700E	999
RNGN120700T6	999
RNGN120700W2	999
RNGN150700	999
RNGN190700	999
RNGX45CH	251
RNLM250600TN	255
RNM_43_	1052
RNM32FT	1012
RNM32SD	1012
RNM42FT	1012
RNM42SD	1012
RNMA250600N	255
RNMG120400	921
RNMG250900	921
RNMG43	921
RNMG86	921
RNMN090300FT	1012
RNMN090300SD	1012
RNMN120300FT	1012
RNMN120300SD	1012
RPCW120400N	255
RPGX090700T6	1000
RPGX120700T6	1000
RPGX35T6	1000
RPGX43CH	250
RPGX45T6	1000
RPLB19	199
RPLB190500FN	255
RPLB190500TN	255
RPLB250700FN	257
RPLB250700TN-VL	257
RPLB250700TN-VL1	256
RPLH190500TN	255
RPLT090400N	244
RPLT120400TN	255
RPLW120400FN	255
RPLW120400TN	255
S CAT50 45° 1" MAS1 O B O	857
S012T08CA040	422
S012T08CA080	422
S012T08HA040	422
S012T08HA078	424
S031T05CA-09	422
S031T05CA-19	422
S031T05CA-40	424
S031T05CA-65	424
S031T05HA-35	424
S031T05SA-05	422
S031T05SA-27	424
S037T05CK-15	423
S037T06CA-12	415
S037T06CA-20	402
S037T06CA-40	424
S037T06CA-70	424
S037T06HA-45	424
S037T06KA-06-05	407
S037T06KA-06-07	410
S037T06KA-06-08	415
S037T06KA-06-11	396

INDEX

Designation	Page	Designation	Page	Designation	Page
S037T06KA-06-18	415	S075T12CA-14	422	S12S-PCLNL-3	1123
S037T06KA-06-28	415	S075T12CA-29	422	S12S-PCLNR-3	1123
S037T06KA-06-D1	400	S075T12CA-40	424	S12S-PTFNL-2	1124
S037T06KA-06-F2	402	S075T12CA-44	422	S12S-PTFNR-2	1124
S037T06KA-06-P1	401	S075T12CA-80	424	S12S-SCLCL-3	1126
S037T06KA-12-98	415	S075T12HA-75	424	S12S-SCLCR-3	1126
S037T06KA-20-05	407	S075T12SA-08	422	S12S-SCLPR-3	1127
S037T06KA-20-F2	402	S08K-SCLCL-2	1126	S12S-SDUCL-3	1128
S037T06SA-06	396	S08K-SCLCR-2	1126	S12S-SDUCR-3	1128
S037T06SA-21	424	S08M-SCLCL-2	1126	S12S-STFCL-2	1131
S037T06SA-32	424	S08M-SCLCL-3	1126	S12S-STFCR-2	1131
S050MOD06CA-40	732	S08M-SCLCR-2	1126	S12S-STFPR-3	1132
S050MOD06CA-50	732	S08M-SCLCR-3	1126	S12S-STUCL-3	1132
S050T06CK-25	423	S08M-SDUCL-2	1128	S12S-STUCR-3	1132
S050T08CA-15	422	S08M-SDUCR-2	1128	S12S-SVQCL-2	1134
S050T08CA-151	422	S08M-STFCL-2	1131	S12S-SVQCR-2	1134
S050T08CA-25	402	S08M-STFCR-2	1131	S12S-SVUCR-2	1135
S050T08CA-251	402	S08M-STFPL-2	1132	S12S-SVXCR-2	1136
S050T08CA-40	424	S08M-STFPR-2	1132	S16	1247
S050T08CA-75	424	S08M-STUCL-2	1132	S16T-CTFPR-3	1115
S050T08HA-55	424	S08M-STUCR-2	1132	S16T-MCLNL-3	1116
S050T08KA-06-05	407	S08R-CTFPR-2	1115	S16T-MCLNL-4	1116
S050T08KA-06-11	396	S08R-SCFPL-2	1127	S16T-MCLNR-4	1116
S050T08KA-06-38	415	S08R-SCFPR-2	1127	S16T-MTFNL-3	1119
S050T08KA-06-48	415	S08R-SCLPL-2	1127	S16T-MTFNR-3	1119
S050T08KA-06-D1	400	S08R-SCLPR-2	1127	S16T-MTUNL-3	1120
S050T08KA-06-F1	402	S100MOD10CK-85	732	S16T-MTUNR-3	1120
S050T08KA-06-F2	402	S100MOD10SK-80	731	S16T-PCLNL-3	1123
S050T08KA-06-P1	401	S100MOD12CA-65	732	S16T-PCLNR-3	1123
S050T08KA-25-05	407	S100MOD12CA-85	732	S16T-PTFNL-2	1124
S050T08KA-25-F1	402	S100MOD12CK-45	732	S16T-PTFNR-2	1124
S050T08KA-25-F2	402	S100MOD12CK-65	732	S16T-SCLCL-3	1126
S050T08SA-06	396	S100MOD12CK-85	732	S16T-SCLCL-4	1126
S050T08SA-061	402	S100MOD12SA-80	730	S16T-SCLCR-3	1126
S050T08SA-37	424	S100T12CK-55	423	S16T-SCLCR-4	1126
S062MOD08CK-40	732	S100T12SK-16	423	S16T-SDUCL-3	1128
S062MOD08CK-55	732	S100T12SK-34	423	S16T-SDUCR-3	1128
S062MOD08CK-70	732	S100T15CA-24	422	S16T-STFCR-3	1131
S062MOD08SK-30	730	S100T15CA-39	422	S16T-STUCL-3	1132
S062T05CK-39	423	S100T15SA-13	422	S16T-STUCR-3	1132
S062T06CK-35	423	S10M-SCLCL-2	1126	S16T-SVQBL-3	1134
S062T06SK-13	423	S10M-SCLCR-2	1126	S16T-SVQBR-3	1134
S062T06SK-21	423	S10R-PCLNL-3	1123	S16T-SVQCL-3	1134
S062T08CK-35	423	S10R-PCLNR-3	1123	S16T-SVQCR-3	1134
S062T08SK-08	423	S10R-PTFNL-2	1124	S16T-SVUCL-3	1135
S062T10CA-34	422	S10R-PTFNR-2	1124	S16T-SVUCR-2	1135
S062T10CA-40	424	S10R-SCLCL-2	1126	S16T-SVXCL-3	1136
S062T10CA-49	422	S10R-SCLCL-3	1126	S16T-SVXCR-2	1136
S062T10CA-80	424	S10R-SCLCR-2	1126	S16T-SVXCR-3	1136
S062T10HA-65	424	S10R-SCLCR-3	1126	S20U-CKUNL-3	1114
S062T10SA-06	422	S10R-SDUCL-2	1128	S20U-CKUNR-3	1114
S062T10SA-40	424	S10R-SDUCR-2	1128	S20U-CTFPR-3	1115
S06H-SCLCL-2	1126	S10R-STFCL-2	1131	S20U-MCLNL-4	1116
S06H-SCLCR-2	1126	S10R-STFCR-2	1131	S20U-MCLNR-4	1116
S06M-SCFPL-2	1127	S10R-STFPL-2	1132	S20U-MSKNL-4	1118
S06M-SCFPR-2	1127	S10R-STFPR-2	1132	S20U-MSKNR-4	1118
S06M-SCLCL-2	1126	S10R-STUCL-2	1132	S20U-MTFNL-3	1119
S06M-SCLCR-2	1126	S10R-STUCR-2	1132	S20U-MTFNR-3	1119
S06M-SCLPL-2	1127	S10S-SCFPL-2	1127	S20U-MTFNR-4	1119
S06M-SCLPR-2	1127	S10S-SCFPR-2	1127	S20U-MTUNL-4	1120
S06M-SDUCL-2	1128	S10S-SCLPL-2	1127	S20U-MTUNR-3	1120
S06M-SDUCR-2	1128	S10S-SCLPR-2	1127	S20U-MTUNR-4	1120
S06M-STFCL-2	1131	S11	1247	S20U-MVUNL-3	1121
S06M-STFCR-2	1131	S125MOD12SK-80	731	S20U-MVUNR-3	1121
S06M-STFPR-2	1132	S125MOD16CK-90	732	S20U-SCLCL-4	1126
S06M-STUCL-2	1132	S125MOD16SK-90	730	S20U-SCLCR-4	1126
S06M-STUCR-2	1132	S125T12SK-31	423	S20U-SDUCL-3	1128
S075MOD08SK-65	731	S125T15CK-50	423	S20U-SDUCR-3	1128
S075MOD10CA-40	732	S125T15CK-80	423	S20U-STFCR-3	1131
S075MOD10CA-60	732	S125T15SK-18	423	S20U-SVUCL-3	1135
S075MOD10CA-80	732	S125T15SK-40	423	S20U-SVUCR-3	1135
S075MOD10SK-30	730	S12S-CTFPL-3	1115	S20U-SVXCL-3	1136
S075T08CK-40	423	S12S-CTFPR-3	1115	S20U-SVXCR-3	1136
S075T08SK-31	423	S12S-MCLNL-3	1116	S22	1247
S075T10CK-40	423	S12S-MCLNL-4	1116	S22T	1251
S075T10CK-62	423	S12S-MCLNR-3	1116	S24U-CTFPR-3	1115
S075T10SA-00	422	S12S-MCLNR-4	1116	S24U-CTFPR-4	1115

Designation	Page
S24U-MCLNL-4	1116
S24U-MCLNR-4	1116
S24U-MCLNR-5	1116
S24U-MSKNL-4	1118
S24U-MTFNL-4	1119
S24U-MTFNR-3	1119
S24U-MTFNR-4	1119
S24U-MTUNL-3	1120
S24U-MTUNL-4	1120
S24U-MTUNR-3	1120
S24U-MTUNR-4	1120
S24U-MVUNL-3	1121
S24U-MVUNR-3	1121
S24U-MVXNL-3	1122
S24U-MVXNR-3	1122
S24U-SCLCL-4	1126
S24U-SCLCR-4	1126
S24U-STFCR-3	1131
S24U-TCLNL-4-CH	1142
S24U-TCLNR-4-CH	1142
S24V-CKUNL-3	1114
S24V-CKUNR-3	1114
S24V-SVQCL-3	1134
S24V-SVQCR-3	1134
S24V-SVUCL-3	1135
S24V-SVUCR-3	1135
S27	1247
S28U-MCLNR-4	1116
S28U-MTFNR-4	1119
S28U-MVXNR-3	1122
S3	1110
S32V-MCLNL-4	1116
S32V-MCLNL-5	1116
S32V-MCLNL-6	1116
S32V-MCLNR-4	1116
S32V-MCLNR-5	1116
S32V-MCLNR-6	1116
S32V-MTFNL-4	1119
S32V-MTFNR-4	1119
S32V-MTUNL-4	1120
S32V-MTUNR-4	1120
S32V-TCLNL-4-CH	1142
S32V-TCLNR-4-CH	1142
S40	1106
S40V-MCLNL-5	1116
S40V-MCLNR-5	1116
S40V-MCLNR-6	1116
S43	1104
S45	1112
S48	1103
SA03-48	191
SA04-42	198
SA-06-37	249
SB-04-13	127
SB060-03	129
SB080-03	169
SC_T32.5_	1074
SC_T43_	1074
SC-04-17	255
SCACR06-2C-SH	1064
SCACR0808K06-SH	1064
SCACR08-3C-SH	1064
SCACR1010K06-SH	1064
SCACR1010K09-SH	1064
SCACR10-3C-SH	1064
SCACR1212K09-SH	1064
SCACR1616K09-SH	1064
SCGT09T308FL	991
SCGT120404FL	991
SCGT120408FL	991
SCGT32.52FL	991
SCGT431FL	991
SCGT432FL	991
SCLCL06-3K	1065
SCLCL08-3A	1065
SCLCL10-3B	1065
SCLCL12-3B	1065

Designation	Page
SCLCL12-4B	1065
SCLCL16-3D	1065
SCLCL16-4D	1065
SCLCR06-2C-SH	1066
SCLCR06-3K	1065
SCLCR0808K06-SH	1066
SCLCR08-3A	1065
SCLCR08-3C-SH	1066
SCLCR1010K06-SH	1066
SCLCR1010K09-SH	1066
SCLCR10-3B	1065
SCLCR10-3C-SH	1066
SCLCR1212K09-SH	1066
SCLCR12-3B	1065
SCLCR12-4B	1065
SCLCR1616K09-SH	1066
SCLCR16-3D	1065
SCLCR16-4D	1065
SCLCR20-4D	1065
SCLT050204N	528
SCLT050204N-P	536
SCLT050204N-PH	528
SCMT09T304MT	974
SCMT09T308FG	973
SCMT09T308MT	974
SCMT120404MT	974
SCMT120408MT	974
SCMT120412MT	974
SCMT32.51MT	974
SCMT32.52FG	973
SCMT32.52MT	974
SCMT431MT	974
SCMT432MT	974
SCMT433MT	974
SCREW 1/2-20 SEM 1	864
SCREW 1/2-20x.500 EM	865
SCREW 1/4-28 SEM 1/2	864
SCREW 1/4-28x.313 EM	865
SCREW 1-1/4x1.250 EM	865
SCREW 1-1/4x7/8 EM	865
SCREW 1-14 SEM 2	864
SCREW 1-14 SEM 2-1/2	864
SCREW 3/4-16 SEM 1-1/2	864
SCREW 3/4-16x.625 EM	865
SCREW 3/8-24 SEM 3/4	864
SCREW 3/8-24x.4375 EM	865
SCREW 5/8-18 SEM 1-1/4	864
SCREW 5/8-18x.500 EM	865
SCREW 7/16-20x.438 EM	865
SD040-16	530
SD-04-46	139
SD-04-85	110
SD-04-86	167
SD050-16	530
SD050-A5	511
SD060-01	198
SD060-20	511
SD-06-46	110
SD-06-47	135
SD-06-48	93
SD-06-49	75
SD-06-89	111
SD-06-99	127
SD-07-06	94
SD08-21	96
SD-08-43	139
SD-08-46	116
SD-08-47	113
SD-08-48	111
SD-08-50	86
SD-08-52	75
SD08-81	103
SD-08-92	111
SD08LA2	96
SD-10-46	268
SD-10-47	129
SD10-48	137

Designation	Page
SD-10-52	83
SD-10-54	88
SD-10-70	273
SD-10-99	268
SD10-A2	103
SD-12-42	253
SD12-54	87
SD-12-79	88
SD-12-82	125
SD-12-89	137
SD-12-99	125
SDCT080305FN-P	53
SDE-31-001	208
SDE-31-002	208
SDE-42-001	208
SDE-42-002	208
SDE-42-003	208
SDGT07T308-HP	528
SDGT140512-HP	528
SDJCL08-2A	1067
SDJCL08-3A	1067
SDJCL08-3C-SH	1068
SDJCL10-3B	1067
SDJCL1212K11-SH	1068
SDJCL12-3B	1067
SDJCL16-3D	1067
SDJCR06-2C-SH	1068
SDJCR06-2J	1067
SDJCR0808K07-SH	1068
SDJCR08-2A	1067
SDJCR08-3A	1067
SDJCR08-3C-SH	1068
SDJCR1010K07-SH	1068
SDJCR1010K11-SH	1068
SDJCR10-3B	1067
SDJCR10-3C-SH	1068
SDJCR1212K11-SH	1068
SDJCR12-3B	1067
SDJCR1616K11-SH	1068
SDJCR16-3D	1067
SDJNL10-3A	1069
SDJNR10-3A	1069
SDJNR12-3B	1069
SDLT07T308N-PH	541
SDLT07T308N-PS	541
SDMT080305N	53
SDMT080308N	53
SDMT080316N	53
SDMT120608R	101
SDMT120608R-HS	101
SDMW080305TN	53
SDMW080305TN-W	53
SDMW080308TN	53
SDNCN06-2C-SH	1070
SDNCN0808K07-SH	1070
SDNCN08-3C-SH	1070
SDNCN1010K07-SH	1070
SDNCN1010K11-SH	1070
SDNCN10-3C-SH	1070
SDNCN1212K11-SH	1070
SDNCN1616K11-SH	1070
SDPCN08-3J	1071
SDPCN10-3B	1071
SDPCN12-3B	1071
SDPCN16-3D	1071
SE06-028-00	230
SE06-037-00	229
SE25-063-10	256
SEALING SLEEVE 4-18	663
SEALING SLEEVE 4-19.5	663
SEALING SLEEVE 4-21.5	663
SEALING SLEEVE 4-23.5	663
SEALING SLEEVE 4-26	663
SEALING SLEEVE 4-28	663
SEALING SLEEVE 4-30.5	663
SEALING SLEEVE 4-33	663
SEALING SLEEVE 4-35.5	663

INDEX

Designation	Page
SEALING SLEEVE 4-39	663
SEALING SLEEVE 4-42.5	663
SEALING SLEEVE 4-46.5	663
SEALING SLEEVE 4-51	663
SEALING SLEEVE 4-55.5	663
SEKT09T3AFFN-P	181
SEKT09T3AFN	181
SEKT12T3AFN-M	182
SELO375D16	1246
SELO500F16	1246
SELO625H16	1246
SELO750K16	1246
SEL1000M16	1246
SEL1000M22	1246
SEL1000M27	1246
SEL1250P16	1246
SEL1250P22	1246
SEL1250P22U	1248
SELW100403N	491
SER0375D16	1246
SER0375H11	1246
SER0500F16	1246
SER0625H16	1246
SER0750K16	1246
SER1000M16	1246
SER1000M22	1246
SER1000M27	1246
SER1250P16	1246
SER1250P22	1246
SER1250P22U	1248
SER1250P27	1246
SER1250P27U	1248
SER1500R27	1246
SET ER 16 SEAL 5 EMI	846
SET ER 16 SEAL 5 EMI JET2	846
SET ER 20 SEAL 5 EMI	846
SET ER 20 SEAL 5 EMI JET2	846
SET ER 25 SEAL 6 EMI	846
SET ER 25 SEAL 6 EMI JET2	846
SET ER 32 SEAL 6 EMI	846
SET ER 32 SEAL 6 EMI JET2	846
SET ER 40 SEAL 7 EMI	846
SET ER 40 SEAL 7 EMI JET2	846
SET ER11 SPR 7	845
SET ER11 SPR 7 AA	845
SET ER16 SEAL 7	845
SET ER16 SEAL 7 JET2	845
SET ER16 SPR 10	845
SET ER16 SPR 10 AA	845
SET ER16 SPR 5 EMI	846
SET ER20 SEAL 10	845
SET ER20 SEAL 10 JET2	845
SET ER20 SPR 12	845
SET ER20 SPR 12 AA	845
SET ER20 SPR 5 EMI	846
SET ER25 SEAL 13	845
SET ER25 SEAL 13 JET2	845
SET ER25 SPR 15	845
SET ER25 SPR 15 AA	845
SET ER25 SPR 6 EMI	846
SET ER32 SEAL 17	845
SET ER32 SEAL 17 JET2	845
SET ER32 SPR 18	845
SET ER32 SPR 18 AA	845
SET ER32 SPR 6 EMI	846
SET ER32 SRK L 6 USA	854
SET ER32 SRK M 6 USA	854
SET ER32 SRK S 6 USA	854
SET ER40 SEAL 23	845
SET ER40 SEAL 23 JET2	845
SET ER40 SPR 23 AA	845
SET ER40 SPR 23	845
SET ER40 SPR 7 EMI	846
SET ER50 SPR 12	845
SF035-01	259
SF070R01	180
SF6H-03R01	159

Designation	Page
SF6H-04R01	159
SF6N-06R01	159
SF6N-08R01	159
SHC7	1115
SHEH1504AEN-P	191
SHEH1504AETN1-P	191
SHET110502FR-P	62
SHET110505FR-P	62
SHET110508FR-P	62
SHET110516FR-P	62
SHET110524FN-P	62
SHET110532FN-P	62
SHET15	199
SHE1504AJTN	191
SHEW1504AJTN	191
SHGT050204-HP	528
SHGT060204-HP	528
SHGT090408-HP	528
SHGT110408-HP	528
SHLT060204N	528
SHLT060204N-PH	528
SHLT09	297
SHLT090308N-HR	92
SHLT090408N	528
SHLT090408N-FS	235
SHLT090408N-PH	539
SHLT090408N-PH1	528
SHLT090416N-FS	297
SHLT11	297
SHLT110408N	528
SHLT110408N-FS	297
SHLT110408N-PH	539
SHLT110408N-PH1	528
SHLT110408TN-HR	92
SHLT110416N-FS	297
SHLT140508N-FS	298
SHLT140508N-PH	539
SHLT140508TN-HR	93
SHLT140516N-FS	298
SHLT140516TN-HR	93
SHLT140532N-FS	298
SHLT1405APTN-H	189
SHM4X0.7X20-MO	1305
SHM5X0.8X10	1327
SHM5X0.8X12	1327
SHM5X0.8X16	1317
SHM5X0.8X20	1317
SHM5X0.8X25	1317
SHM6X1X16	1317
SHM6X1X20	1317
SHM6X1X25	1309
SHM6X1X40	1309
SHM8X1.25X20	1318
SHM8X1.25X25	1318
SHRINKIN UNIT V2 USA	853
SHU-20015D1R01	299
SHU-25015D1R01	299
SHU-30020D3R01	299
SHU-40022D5R01	299
SIL0265K08	1250
SIL0310K08U	1252
SIL0375H11	1250
SIL0375K11	1250
SIL0500L11	1250
SIL0500M16	1250
SIL0500P11C	1254
SIL0625P16	1250
SIL0625R16C	1254
SIL0750P16	1250
SIL0750P22	1250
SIL1000R16	1250
SIL1000R22	1250
SIL1250S16	1250
SIL1250S22	1250
SIL1250S27	1250
SIL1250S27U	1252
SIL1500T16	1250

Designation	Page
SIL1500T22	1250
SIL1500T27	1250
SIRO205H06C	1254
SIRO265K08	1250
SIRO265K08C	1254
SIRO310K08U	1252
SIRO310K08UC	1255
SIRO375H11	1250
SIRO375K11	1250
SIRO375M11C	1254
SIRO500L11	1250
SIRO500M16	1250
SIRO500P11C	1254
SIRO625P16	1250
SIRO625R16C	1254
SIRO750P16	1250
SIRO750P22	1250
SIR1000R16	1250
SIR1000R22	1250
SIR1250S16	1250
SIR1250S22	1250
SIR1250S22U	1252
SIR1250S27	1250
SIR1250S27U	1252
SIR1500T16	1250
SIR1500T22	1250
SIR1500T22U	1252
SIR1500T27	1250
SIR2000U27	1250
SIR2500V27	1250
SJ-0029	182
SJ2J-05R01	144
SJ2J-06R01	144
SJ2J-08R01	144
SJ2N-04A01	148
SJ2N-04A02	148
SJ2N-05A01	148
SJ2N-05A02	148
SJ2N-06A01	148
SJ2N-06A02	148
SJ2N-08A01	148
SJ2N-08A02	148
SJ2N-10A01	148
SJ2N-10A02	148
SJ2N-12A01	148
SJ2N-12A02	148
SJ2R-06R01	150
SJ2R-08R01	150
SJ2R-10R01	150
SJ2R-12R01	150
SJ-5062	180
SJ5F-03R01	140
SJ5F-04R01	140
SJ5J-03R01	142
SJ5J-04R01	142
SJ5Y-01R01	138
SJ5Y-02R01	138
SJ5Y-02R02	138
SJ5Y-03R01	138
SJ6F-02R01	140
SJ6F-02R02	140
SJ6F-03R01	140
SJ6F-04R01	140
SJ6F-05R01	140
SJ6J-03R01	142
SJ6J-04R01	142
SJ6N-03R01	146
SJ6N-04R01	146
SJ6N-05R01	146
SJ6N-06R01	146
SJ6N-08R01	146
SJ6N-10R01	146
SJ6N-12R01	146
SJ6Y-01R01	138
SJ6Y-02R01	138
SJ6Y-02R02	138
SJ6Y-03R01	138

Designation	Page
SK40	728
SK50	728
SM18-041-00	15
SM20-043-00	529
SM22-037-00	540
SM22-046-00	509
SM22-052-00	235
SM25-049-00	259
SM25-052-80	293
SM25-054-00	21
SM25-064-00	21
SM25-065-70	1064
SM25-075-20	282
SM25-075-60	263
SM30-053-00	259
SM30-055-10	530
SM30-065-00	53
SM30-074-21	45
SM30-080-10	293
SM30-082-00	55
SM30-082-21	45
SM30-082-B0	287
SM35-034-50	209
SM35-042-50	209
SM35-076-10	25
SM35-088-10	33
SM35-088-60	529
SM35-089-00	228
SM35-097-00	245
SM35-110-00	182
SM35-110-R0	129
SM35-114-H0	49
SM-36	1044
SM-37	1045
SM-40	1044
SM40-050-50	209
SM40-060-50	209
SM40-070-00	58
SM40-070-10	259
SM40-080-10	259
SM40-080-30	39
SM40-084-20	35
SM40-090-00	135
SM40-093-10	35
SM40-093-20	39
SM40-100-00	212
SM40-100-10	167
SM40-100-R0	131
SM40-106-B0	287
SM40-120-20	42
SM40-140-00	293
SM40-143-H0	87
SM-41	1045
SM45-120-R0	132
SM50-062-S0	182
SM50-096-20	540
SM50-100-10	61
SM50-105-10	279
SM50-107-10	1137
SM50-120-10	281
SM50-120-30	173
SM50-122-50	529
SM50-127-10	89
SM50-130-R0	171
SM50-138-B0	287
SM50-160-10	88
SM60-127-00	253
SM60-150-00	199
SM60-165-B0	287
SM60-180-00	293
SM70-210-B0	287
SM80-250-B0	287
SN_32_	1053
SN_43_	1055
SN_54_	1053
SN_64_	1053
SN2J-03R01	194

Designation	Page
SN2J-04R01	194
SN2J-06R01	194
SN2N-04A01	196
SN2N-04A02	196
SN2N-05A01	196
SN2N-05A02	196
SN2N-06A01	196
SN2N-06A02	196
SN2N-08A01	196
SN2N-08A02	196
SN2N-10A01	196
SN2N-10A02	196
SN2N-12A01	196
SN2N-12A02	196
SN2R-04R01	200
SN2R-06R01	200
SN2R-08R01	200
SN2R-10R01	200
SN2R-12R01	200
SN6J-03R01	194
SN6J-04R01	194
SN6J-06R01	194
SNED120420	129
SNED1204ANR-DT	129
SNES1204ANN	129
SNEV1204ANN-PH	129
SNG43_	1106
SNG431	1001
SNG432	1001
SNG432E	1001
SNG432LN	1013
SNG433	1001
SNG433LN	1013
SNG434	1001
SNG45_	1106
SNG452	1001
SNG453	1001
SNG454	1001
SNGA120404	1000
SNGA120408	1000
SNGA120408E	1000
SNGA120412	1000
SNGA431	1000
SNGA432	1000
SNGA432E	1000
SNGA433	1000
SNGN 120404	1001
SNGN 120408	1001
SNGN 120408E	1001
SNGN 120412	1001
SNGN 120416	1001
SNGN 120708	1001
SNGN 120712	1001
SNGN 120716	1001
SNGN120408LN	1013
SNGN120412LN	1013
SNGS1205ANN-W	187
SNGU1205EFN-P	185
SNGU1205ENN	185
SNGU130604N	131
SNGU130608TN	131
SNGU130616N	131
SNGU1306ANTN	131
SNGX120712CH	1002
SNGX120712T7-CH	1002
SNGX120716CH	1002
SNGX120716T7-CH	1002
SNGX150716T7-CH	1002
SNGX45_CH	1113
SNGX453CH	1002
SNGX453T7-CH	1002
SNGX454CH	1002
SNGX454T7-CH	1002
SNGX554T7-CH	1002
SNM322SD	1014
SNM323SD	1014
SNM324SD	1014

Designation	Page
SNM423SD	1014
SNM424SD	1014
SNMA120404LN	1013
SNMA120408	922
SNMA120408LN	1013
SNMA120408LN-10	1020
SNMA120412	922
SNMA120412LN-10	1020
SNMA120416	922
SNMA150612	922
SNMA150616	922
SNMA190612	922
SNMA190616	922
SNMA250716	922
SNMA250724	922
SNMA431LN	1013
SNMA432	922
SNMA432LN	1013
SNMA432LN-10	1020
SNMA433	922
SNMA433LN-10	1020
SNMA434	922
SNMA543	922
SNMA544	922
SNMA643	922
SNMA644	922
SNMA854	922
SNMA856	922
SNMG090304	923
SNMG090304FG	924
SNMG090308	923
SNMG090308FG	924
SNMG090308MT	926
SNMG090308PC	927
SNMG120404	923
SNMG120404FG	924
SNMG120404MP	925
SNMG120404MT	926
SNMG120404PC	927
SNMG120408	923
SNMG120408CE	1002
SNMG120408FG	924
SNMG120408MBC	924
SNMG120408ML	925
SNMG120408MP	925
SNMG120408MT	926
SNMG120408PC	927
SNMG120408RT	928
SNMG120412	923
SNMG120412MC	924
SNMG120412ML	925
SNMG120412MP	925
SNMG120412MT	926
SNMG120412PC	927
SNMG120412RT	928
SNMG120416	923
SNMG150608	923
SNMG150612	923
SNMG150612MT	926
SNMG150612RT	928
SNMG150616	923
SNMG190604	923
SNMG190608	923
SNMG190608MT	926
SNMG190612	923
SNMG190612MT	926
SNMG190612RT	928
SNMG190616	923
SNMG190616RT	928
SNMG250716	923
SNMG250724	923
SNMG250924	923
SNMG250924RT	928
SNMG321	923
SNMG321FG	924
SNMG322	923
SNMG322FG	924

INDEX

Designation	Page
SNMG322MT	926
SNMG322PC	927
SNMG431	923
SNMG431FG	924
SNMG431MP	925
SNMG431MT	926
SNMG431PC	927
SNMG432	923
SNMG432CE	1002
SNMG432FG	924
SNMG432MC	924
SNMG432ML	925
SNMG432MP	925
SNMG432MT	926
SNMG432PC	927
SNMG432RT	928
SNMG433	923
SNMG433MC	924
SNMG433ML	925
SNMG433MP	925
SNMG433MT	926
SNMG433PC	927
SNMG433RT	928
SNMG434	923
SNMG542	923
SNMG543	923
SNMG543MT	926
SNMG543RT	928
SNMG544	923
SNMG641	923
SNMG642	923
SNMG642MT	926
SNMG643	923
SNMG643MT	926
SNMG643RT	928
SNMG644	923
SNMG644RT	928
SNMG854	923
SNMG856	923
SNMG866	923
SNMG866RT	928
SNMM120408RH	931
SNMM120408RH(N)	931
SNMM120412RH	931
SNMM120412RH(N)	931
SNMM120416RH	931
SNMM150612RH	931
SNMM190608RH	931
SNMM190612HT	929
SNMM190612RH	931
SNMM190612RH(N)	931
SNMM190616HT	929
SNMM190616RH	931
SNMM190616RH(N)	931
SNMM190624	929
SNMM190624HT	929
SNMM190624RH	931
SNMM250716RH	931
SNMM250724HT	929
SNMM250724RH	931
SNMM250924	929
SNMM250924HT	929
SNMM250924HZ	930
SNMM250924RH	931
SNMM250932HT	929
SNMM432RH	931
SNMM432RH(N)	931
SNMM433RH	931
SNMM433RH(N)	931
SNMM434RH	931
SNMM543RH	931
SNMM642RH	931
SNMM643HT	929
SNMM643RH	931
SNMM643RH(N)	931
SNMM644HT	929
SNMM644RH	931

Designation	Page
SNMM644RH(N)	931
SNMM646HT	929
SNMM646HY	929
SNMM646RH	931
SNMM854RH	931
SNMM856HT	929
SNMM856RH	931
SNMM866HT	929
SNMM866HY	929
SNMM866HZ	930
SNMM866RH	931
SNMM868HT	929
SNMN090308SD	1014
SNMN090312SD	1014
SNMN090316SD	1014
SNMN120312SD	1014
SNMN120316SD	1014
SO35080I	1064
SO35120I	1069
SO40050I	1085
SO40085I	1087
SO40090I	1102
SO50090I	1138
SO50090S	1069
SO80180I	1087
SP_32_	1044
SP_42_	1044
SP_63_	1044
SP6H-02R01	272
SP6H-02R02	272
SP6H-03R02	272
SP6H-04R02	272
SP6N-04R01	272
SP6N-04R02	272
SP6N-06R01	272
SP6N-06R02	272
SP6N-08R01	272
SP6N-08R02	272
SPEN120608T	127
SPEN120611TR-W	127
SPEN1206MPTN	127
SPEN1206MPTR-W	127
SPG321	975
SPG322	975
SPG421	975
SPG422	975
SPG423	975
SPG431	975
SPG432	975
SPG433	975
SPG434	975
SPG531	975
SPG532	975
SPG533	975
SPG631	975
SPG632	975
SPGN090304	975
SPGN090308	975
SPGN120304	975
SPGN120308	975
SPGN120312	975
SPGN120404	975
SPGN120408	975
SPGN120412	975
SPGN120416	975
SPGN150404	975
SPGN150408	975
SPGN150412	975
SPGN190404	975
SPGN190408	975
SPLT060204R	235
SPLT060204R-DM04	539
SPLT07	297
SPLT07T308N	528
SPLT07T308N-PH	297
SPLT120408N-PH	532
SPLT140512N	528

Designation	Page
SPLT140512N-PH	528
SPMR090304	976
SPMR090308	976
SPMR120304	976
SPMR120308	976
SPMR120312	976
SPMR321	976
SPMR322	976
SPMR421	976
SPMR422	976
SPMR423	976
SPU321	977
SPU322	977
SPU421	977
SPU422	977
SPU423	977
SPU531	977
SPU633	977
SPUN090304	977
SPUN090308	977
SPUN120304	977
SPUN120308	977
SPUN120312	977
SPUN150404	977
SPUN190412	977
SR14	1251
SR14-552	1254
SR14-558	1253
SR16-212	1074
SR16-236P	1065
SR34-535	1321
SR-76-1021	1335
SR-76-1022	1335
SRDCN10-3A	1072
SRDCN12-3B	1072
SRDCN16-4D	1072
SRM6X30	1309
SSD32	1069
SSDCN08-3A	1074
SSDCN10-3B	1074
SSDCN12-3B	1074
SSDCN12-4B	1074
SSDCN16-4D	1074
SSVN2.522	1133
SSXMBX1,25X10-C	1384
SSXMBX1,25X12-C	1384
SSXMBX1,25X8-C	1384
SSXMBX1,5X10-C	1384
ST 1/2X6.30 SRK 1/8	832
ST 1/2X6.30 SRK 3/16	832
ST 12x160 SRK 3	833
ST 12x160 SRK 4	833
ST 16X 35 ER16 MF	828
ST 16X 38 ER11 MF	828
ST 16X 50 ER11 MF D	830
ST 16X140 ER11 MF	828
ST 16x160 SRK 3	833
ST 16x160 SRK 4	833
ST 16x160 SRK 5	833
ST 16x160 SRK 6	833
ST 1X8.000 SRK 1/2	832
ST 1X8.000 SRK 1/4	832
ST 1X8.000 SRK 3/8	832
ST 1X8.000 SRK 5/16	832
ST 20X 30 ER11 MF D	830
ST 20X 50 ER11 MF D	830
ST 20X 50 ER16 MF	828
ST 20X 55 ER16 MF D	830
ST 20X 70 ER16 MF	828
ST 20X120 ER16 MF	828
ST 20x200 SRK 5	833
ST 20x200 SRK 6	833
ST 20x200 SRK 8	833
ST 22X 38 ER16 MF	828
ST 22X 55 ER16 MF D	830
ST 22X 70 ER16 MF	828

Designation	Page
ST 22X 70 ER25 MF	828
ST 22X 75 ER16 MF D	830
ST 22X 80 ER20 MF	828
ST 22X100 ER16 MF	828
ST 25X 62 ER16 MF D	830
ST 25X 65 ER16 MF	828
ST 25X 75 ER25 MF	828
ST 25X100 ER20 MF	828
ST 25X145 ER25 MF	828
ST 25X154 ER20 MF	828
ST 25x200 SRK 10	833
ST 25x200 SRK 12	833
ST 25x200 SRK 6	833
ST 25x200 SRK 8	833
ST 3/4X8.00 SRK 1/4	832
ST 3/4X8.00 SRK 3/16	832
ST 3/4X8.00 SRK 5/16	832
ST 32X 55 ER20 MF D	830
ST 32X 70 ER25 MF	828
ST 32X 75 ER20 MF D	830
ST 5/8X6.30 SRK 1/4	832
ST 5/8X6.30 SRK 1/8	832
ST 5/8X6.30 SRK 3/16	832
ST1 X2.559 ER16 MF	827
ST1 X2.953 ER16 MF	827
ST1 X3.937 ER16 MF	827
ST1 X3.937 ER20 MF	827
ST1 X5.512 ER20 MF	827
ST1 X2.441 ER16 MF D	829
ST1/2X4.000 ER11 M	824
ST1/2X4.000 ER16 M	824
ST1-1/4X2.37 ER40	826
ST1-1/4X2.375 ER32F	826
ST1-1/4X3.000 ER40S	831
ST1-1/4X6.00 ER32	826
ST1X2.00 ER32F	826
ST1X2.37 ER40F	826
ST1X3.000 ER32S	831
ST3/4 X1.496 ER16 MF	827
ST3/4 X1.969 ER16 MF	827
ST3/4 X2.756 ER16 MF	827
ST3/4 X4.724 ER16 MF	827
ST3/4 X5.512 ER16 MF	827
ST3/4X2.00 ER25F	826
ST3/4X2.00 ER32F	826
ST3/4X2.165 ER16 MF D	829
ST3/4X2.50 ER11F	825
ST3/4X2.50 ER16F	825
ST3/4X2.50 ER20F	825
ST3/4X2.500 ER16MF	824
ST3/4X2.500 ER20MF	824
ST3/4X2.756 ER11 MF D	829
ST3/4X3.000 ER16S	831
ST3/4X3.000 ER20S	831
ST3/4X3.000 ER25S	831
ST3/4X4.00 ER11	825
ST3/4X4.00 ER16	825
ST3/4X4.00 ER20	825
ST3/4X4.00 ER25	826
ST3/4X4.000 ER16MF	824
ST3/4X4.000 ER20 M	824
ST3/4X6.00 ER11	825
ST3/4X6.00 ER16	825
ST3/4X6.00 ER20	825
ST3/4X6.000 ER16 M	824
ST3/4X6.000 ER20 M	824
ST5/8X1.250 ER16 M	824
ST5/8X2.50 ER11F	825
ST5/8X2.500 ER11MF	824
ST5/8X4.000 ER11 M	824
ST5/8X6.000 ER11 M	824
STFCL06-2	1075
STFCL08-2J	1075
STFCL10-2A	1075
STFCL12-3B	1075
STFCL16-3D	1075
STFCR06-2	1075

Designation	Page
STFCR08-2J	1075
STFCR10-2A	1075
STFCR12-3B	1075
STFCR16-3D	1075
STGCL06-2	1076
STGCL08-2J	1076
STGCL12-3B	1076
STGCL16-3D	1076
STGCR06-2	1076
STGCR06-2C-SH	1077
STGCR08-2C-SH	1077
STGCR08-2J	1076
STGCR1010K11-SH	1077
STGCR10-2A	1076
STGCR10-2C-SH	1077
STGCR10-3B	1076
STGCR1212K11-SH	1077
STGCR12-3B	1076
STGCR1616K11-SH	1077
STGCR16-3D	1076
STGD-03175-0254-76-IN05S	584
STGD-03175-0559-76-IN05S	584
STGD-03175-0914-76-IN05S	584
STGD-03962-0914-76-IN05S	584
STGD-04763-0254-76-IN05S	584
STGD-04763-0711-76-IN05S	584
STGD-04763-1219-76-IN05S	584
STGD-06350-0254-76-IN05S	584
STGD-06350-0711-76-IN05S	584
STGD-06350-1219-76-IN05S	584
STGD-07938-0254-76-IN05S	584
STGD-07938-0711-76-IN05S	584
STGD-07938-1219-76-IN05S	584
STGD-09525-0254-76-IN05S	584
STGD-09525-0711-76-IN05S	584
STGD-09525-1219-76-IN05S	584
STGD-11113-0254-76-IN05S	584
STGD-11113-0711-76-IN05S	584
STGD-11113-1219-76-IN05S	584
STGD-11113-1524-76-IN05S	584
STGD-11506-0254-76-IN05S	584
STGD-11506-0711-76-IN05S	584
STGD-11506-1219-76-IN05S	584
STGD-11506-1524-76-IN05S	584
STGD-12700-0254-76-IN05S	584
STGD-12700-0711-76-IN05S	584
STGD-12700-1219-58-IN05S	584
STGD-12700-1524-58-IN05S	584
STGD-14288-0406-58-IN05S	584
STGD-14288-0711-58-IN05S	584
STGD-14288-1219-58-IN05S	584
STGD-14681-0254-58-IN05S	584
STGD-14681-0711-58-IN05S	584
STGD-14681-1219-58-IN05S	584
STGD-14681-1524-58-IN05S	584
STGD-15062-0254-58-IN05S	584
STGD-15062-0711-58-IN05S	584
STGD-15062-1219-58-IN05S	584
STGD-15062-1524-58-IN05S	584
STGD-15875-0406-58-IN05S	585
STGD-15875-0711-58-IN05S	585
STGD-15875-1219-58-IN05S	585
STGD-19837-0254-58-IN05S	585
STGD-19837-0711-58-IN05S	585
STGD-19837-1219-58-IN05S	585
STGD-19837-1524-58-IN05S	585
STGD-20638-0254-58-IN05S	585
STGD-20638-0711-58-IN05S	585
STGD-20638-1219-58-IN05S	585
STGD-20638-1524-58-IN05S	585
STGD-25400-0559-59-IN05S	585
STGD-25400-0914-59-IN05S	585
STGD-25400-1219-59-IN05S	585
SVJBL1212K11-SH	1079
SVJBL12-3B	1078
SVJBL16-3D	1078
SVJBR06-2C-SH	1079

Designation	Page
SVJBR08-2C-SH	1079
SVJBR1010K11-SH	1079
SVJBR10-2C-SH	1079
SVJBR1212K11-SH	1079
SVJBR12-3B	1078
SVJBR1616K11-SH	1079
SVJBR16-3D	1078
SVJBR20-3D	1078
SVJCL08-2A	1080
SVJCL10-2B	1080
SVJCL12-3B	1080
SVJCL16-3D	1080
SVJCL20-3D	1080
SVJCR08-2A	1080
SVJCR10-2B	1080
SVJCR12-3B	1080
SVJCR16-3D	1080
SVJCR20-3D	1080
SVVBN06-2C-SH	1082
SVVBN08-2C-SH	1082
SVVBN1010K11-SH	1082
SVVBN10-2C-SH	1082
SVVBN1212K11-SH	1082
SVVBN12-3B	1082
SVVBN1616K11-SH	1082
SVVBN16-3D	1082
SVVBN20-3D	1082
SVVCN12-3B	1083
SVVCN16-3D	1083
SW6-T	511
T05T05SA-10	426
T06T06SA-10	426
T08T08SA-10	426
T10	1115
T10P	1380
T10T10SA-15	426
T11-3219	1007
T12T12SA-15	426
T15	595
T15T15SA-17	426
T20	602
T6P	1380
T7	600
T7P	1380
T8	600
T8P	1380
T9	595
TB103	640
TB203	640
TB253	640
TB293	640
TBTA3-x.xxxDE4-35.5	599
TBTA3-x.xxxDE4-39	599
TBTA3-x.xxxDE4-42.5	599
TBTA3-x.xxxDE4-46.5	599
TBTA3-x.xxxDE4-51	599
TBTA3-x.xxxDE4-55.5	599
TBTA3-x.xxxDE4-56	599
TBTA3-x.xxxDE4-62	599
TBTA3-x.xxxDE4-75	599
TBTA3-x.xxxDE4-82	599
TBTA3-x.xxxDE4-94	599
TBTA3-x.xxxSE4-33	597
TBTA3-x.xxxSE4-36	597
TBTA3-x.xxxSE4-39	597
TBTA3-x.xxxSE4-43	597
TBTA3-x.xxxSE4-47	597
TBTA3-x.xxxSE4-51	597
TBTA3-x.xxxSE4-56	597
TBTA3-x.xxxSE4-62	597
TBTA3-x.xxxSE4-68	597
TBTA3-x.xxxSE4-75	597
TBTA3-x.xxxSE4-82	597
TBTA3-x.xxxSE4-94	597
TBTA3-x.xxxS11-3	598
TBTA3-x.xxxS11-33	598
TBTA3-x.xxxS11-39	598

INDEX

Designation	Page
TBTA3-x.xxxSI1-43	598
TBTA3-x.xxxSI1-47	598
TBTA3-x.xxxSI1-51	598
TBTA3-x.xxxSI1-56	598
TBTA3-x.xxxSI1-62	598
TBTA3-x.xxxSI1-68	598
TBTA3-x.xxxSI1-75	598
TBTA3-x.xxxSI1-82	598
TBTA3-x.xxxSI1-94	598
TBTA5-x.xxxSE4-094	603
TBTA5-x.xxxSE4-106	603
TBTA5-x.xxxSE4-118	603
TBTA5-x.xxxSE4-130	603
TBTA5-x.xxxSE4-142	603
TBTA5-x.xxxSE4-154	603
TBTA5-x.xxxSI1-094	604
TBTA5-x.xxxSI1-106	604
TBTA5-x.xxxSI1-118	604
TBTA5-x.xxxSI1-130	604
TBTA5-x.xxxSI1-142	604
TBTA5-x.xxxSI1-154	604
TBTA7-x.xxxSE4-154	608
TBTA7-x.xxxSE4-166	608
TBTA7-x.xxxSE4-178	608
TBTA7-x.xxxSE4-190	608
TBTA7-x.xxxSE4-202	608
TBTA7-x.xxxSE4-214	608
TBTA7-x.xxxSE4-226	608
TBTA7-x.xxxSI1-154	609
TBTA7-x.xxxSI1-166	609
TBTA7-x.xxxSI1-178	609
TBTA7-x.xxxSI1-190	609
TBTA7-x.xxxSI1-202	609
TBTA7-x.xxxSI1-214	609
TBTA7-x.xxxSI1-226	609
TBTA-Ax.xxxSE4-26	613
TBTA-Ax.xxxSE4-28	613
TBTA-Ax.xxxSE4-30	613
TBTA-Ax.xxxSE4-33	613
TBTA-Ax.xxxSI1-24	614
TBTA-Ax.xxxSI1-26	614
TBTA-Ax.xxxSI1-28	614
TBTA-Ax.xxxSI1-30	614
TBTA-Ax.xxxSI1-33	614
TBTA-Bx.xxxSE4-14	617
TBTA-Bx.xxxSE4-15	617
TBTA-Bx.xxxSE4-16	617
TBTA-Bx.xxxSE4-17	617
TBTA-Bx.xxxSE4-18	617
TBTA-Bx.xxxSE4-20	617
TBTA-Bx.xxxSE4-22	617
TBTA-Bx.xxxSE4-24	617
TBTA-Bx.xxxSI1-13	618
TBTA-Bx.xxxSI1-14	618
TBTA-Bx.xxxSI1-15	618
TBTA-Bx.xxxSI1-16.5	618
TBTA-Bx.xxxSI1-18	618
TBTA-Bx.xxxSI1-20	618
TBTA-Bx.xxxSI1-22	618
TBTA-Bx.xxxSI1-24	618
TBTA-Cx.xxxDE4-23.5	622
TBTA-Cx.xxxDE4-26	622
TBTA-Cx.xxxDE4-28	622
TBTA-Cx.xxxDE4-30.5	622
TBTA-Cx.xxxDE4-33	622
TBTA-Cx.xxxDE4-35.5	622
TBTA-Cx.xxxDE4-39	622
TBTA-Cx.xxxDE4-42.5	622
TBTA-Cx.xxxDE4-46.5	622
TBTA-Cx.xxxDE4-51	622
TBTA-Cx.xxxSE4-22	621
TBTA-Cx.xxxSE4-24	621
TBTA-Cx.xxxSE4-26	621
TBTA-Cx.xxxSE4-28	621
TBTA-Cx.xxxSE4-30	621
TBTA-Cx.xxxSE4-33	621
TBTA-Cx.xxxSE4-36	621

Designation	Page
TBTA-Cx.xxxSE4-39	621
TBTA-Cx.xxxSE4-43	621
TBTA-Cx.xxxSE4-47	621
TBTA-Dx.xxxDE4-28	626
TBTA-Dx.xxxDE4-30.5	626
TBTA-Dx.xxxDE4-33	626
TBTA-Dx.xxxDE4-35.5	626
TBTA-Dx.xxxDE4-39	626
TBTA-Dx.xxxDE4-42.5	626
TBTA-Dx.xxxDE4-46.5	626
TBTA-Dx.xxxDE4-51	626
TBTA-Dx.xxxDE4-55.5	626
TBTA-Dx.xxxSE4-26	625
TBTA-Dx.xxxSE4-28	625
TBTA-Dx.xxxSE4-30	625
TBTA-Dx.xxxSE4-33	625
TBTA-Dx.xxxSE4-36	625
TBTA-Dx.xxxSE4-39	625
TBTA-Dx.xxxSE4-43	625
TBTA-Dx.xxxSE4-47	625
TBTA-Dx.xxxSE4-51	625
TBTA-Dx.xxxSE4-56	625
TBTA-Lx.xxxSE4-106	630
TBTA-Lx.xxxSE4-118	630
TBTA-Lx.xxxSE4-130	630
TBTA-Lx.xxxSE4-142	630
TBTA-Lx.xxxSE4-154	630
TBTA-Lx.xxxSE4-166	630
TBTA-Lx.xxxSE4-56A	630
TBTA-Lx.xxxSE4-56B	630
TBTA-Lx.xxxSE4-62	630
TBTA-Lx.xxxSE4-68	630
TBTA-Lx.xxxSE4-75	630
TBTA-Lx.xxxSE4-82	630
TBTA-Lx.xxxSE4-94	630
TBTA-R-x.xxxSE4-36	644
TBTA-R-x.xxxSE4-39	644
TBTA-R-x.xxxSE4-43	644
TBTA-R-x.xxxSE4-47	644
TBTA-R-x.xxxSE4-51	644
TBTA-R-x.xxxSE4-56	644
TBTA-R-x.xxxSE4-62	644
TBTA-R-x.xxxSE4-68	644
TBTA-R-x.xxxSE4-75	644
TBTA-R-x.xxxSE4-82	644
TBTA-R-x.xxxSI1-22	645
TBTA-R-x.xxxSI1-24	645
TBTA-R-x.xxxSI1-26	645
TBTA-R-x.xxxSI1-28	645
TBTA-R-x.xxxSI1-30	645
TBTA-R-x.xxxSI1-33	645
TBTA-R-x.xxxSI1-36	646
TBTA-R-x.xxxSI1-39	646
TBTA-R-x.xxxSI1-43	646
TBTA-R-x.xxxSI1-47	646
TBTA-R-x.xxxSI1-51	646
TBTA-R-x.xxxSI1-56	646
TBTA-R-x.xxxSI1-62	646
TBTA-R-x.xxxSI1-68	646
TBTA-R-x.xxxSI1-75	646
TBTA-R-x.xxxSI1-82	646
TBTA-R-x.xxxSI1-94	646
TC_T21.5_	1075
TC_T22_	1077
TC_T32.5	1075
TCAP08L-2.25DN	1381
TCAP08L-2.25DN-IN	1380
TCAP08R/L	1385
TCAP08R/L (-IN)	1385
TCAP08R-2.25DN	1381
TCAP08R-2.25DN-IN	1380
TCAP08R-3.0DN12.7	1381
TCAP10L-2.25DN	1381
TCAP10L-2.25DN-IN	1380
TCAP10R/L	1385
TCAP10R/L (-IN)	1385
TCAP10R-2.25DN	1381

Designation	Page
TCAP10R-2.25DN-IN	1380
TCAP10R-3.0DN12.7	1381
TCAP12L-2.25DN	1381
TCAP12L-2.25DN-IN	1380
TCAP12R/L	1385
TCAP12R/L or 14R/L	1385
TCAP12R-2.25DN	1381
TCAP12R-2.25DN-IN	1380
TCAP12R-3.0DN15.88	1381
TCAP14L-2.25DN	1381
TCAP14L-2.25DN-IN	1380
TCAP14R-2.25DN	1381
TCAP14R-2.25DN-IN	1380
TCAP14R-3.0DN15.88	1381
TCAP16L-2.25DN	1381
TCAP16L-2.25DN-IN	1380
TCAP16R/L	1385
TCAP16R-2.25DN	1381
TCAP16R-2.25DN-IN	1380
TCAP16R-3.0DN19.05	1381
TCAP20L-2.25DN	1381
TCAP20L-2.25DN-IN	1380
TCAP20R/L	1385
TCAP20R-2.25DN	1381
TCAP20R-2.25DN-IN	1380
TCAP20R-3.0DN25.4	1381
TCAP25L-2.25DN-IN	1380
TCAP25R-2.25DN	1381
TCAP25R-2.25DN-IN	1380
TCAP32R-2.25DN-IN	1380
TCEL	1311
TCEL3T16	1314
TCEL4T16	1314
TCEL5T20	1314
TCEL6T20	1314
TCEL8T25	1314
TCER	1311
TCER3T16	1314
TCER4T16	1314
TCER5T20	1314
TCER6T20	1314
TCER8T25	1314
TCET110301L-GF	978
TCET110301R-GF	978
TCET110302L-GF	978
TCET110302R-GF	978
TCET110304R-GF	978
TCET220.5L-GF	978
TCET220.5R-GF	978
TCET220L-GF	978
TCET220R-GF	978
TCET221R-GF	978
TCFL	1313
TCFL3T12-100-140RN	1316
TCFL3T12-140-200RN	1316
TCFL3T12-40-55RN	1316
TCFL3T12-55-75RN	1316
TCFL3T12-75-100RN	1316
TCFL4T16-100-150RN	1316
TCFL4T16-150-250RN	1316
TCFL4T16-50-70RN	1316
TCFL4T16-70-100RN	1316
TCFL5T20-120-180RN	1316
TCFL5T20-180-300RN	1316
TCFL5T20-55-80RN	1316
TCFL5T20-80-120RN	1316
TCFL6T25-150-250RN	1316
TCFL6T25-250-400RN	1316
TCFL6T25-60-90RN	1316
TCFL6T25-90-150RN	1316
TCFR	1311
TCFR3T12-100-140RN	1315
TCFR3T12-140-200RN	1315
TCFR3T12-40-55RN	1315
TCFR3T12-55-75RN	1315
TCFR3T12-75-100RN	1315
TCFR4T16-100-150RN	1315

Designation	Page
TCFR4T16-150-250RN	1315
TCFR4T16-50-70RN	1315
TCFR4T16-70-100RN	1315
TCFR5T20-120-180RN	1315
TCFR5T20-180-300RN	1315
TCFR5T20-55-80RN	1315
TCFR5T20-80-120RN	1315
TCFR6T25-150-250RN	1315
TCFR6T25-250-400RN	1315
TCFR6T25-60-90RN	1315
TCFR6T25-90-150RN	1315
TCGT090204FL	992
TCGT110204FL	992
TCGT16T304FL	992
TCGT16T308FL	992
TCGT21.51FL	992
TCGT32.51FL	992
TCGT32.52FL	992
TCGT731FL	992
TCGW090204LN-7	1020
TCGW090208LN-7	1020
TCGW110204LN-7	1020
TCGW110204LS	1014
TCGW110208LN-7	1020
TCGW110208LS	1014
TCGW16T304LN-7	1020
TCGW16T304LS	1014
TCGW16T308LN-7	1020
TCGW16T308LS	1014
TCGW21.51LN-7	1020
TCGW21.51LS	1014
TCGW21.52LN-7	1020
TCGW21.52LS	1014
TCGW32.51LN-7	1020
TCGW32.51LS	1014
TCGW32.52LN-7	1020
TCGW32.52LS	1014
TCGW731LN-7	1020
TCGW732LN-7	1020
TCHL	1314
TCHL19	1311
TCHL25.4	1311
TCHL31.8	1311
TCHPL	1314
TCHPL19	1312
TCHPL25.4	1312
TCHPL31.8	1312
TCHPR	1314
TCHPR19	1312
TCHPR25.4	1312
TCHPR31.8	1312
TCHR	1314
TCHR19	1311
TCHR25.4	1311
TCHR31.8	1311
TCKNL12-4B	1084
TCKNL16-4D	1084
TCKNL20-4D	1084
TCKNR12-4B	1084
TCKNR16-4D	1084
TCKNR20-4D	1084
TCLNL12-3B	1086
TCLNL12-4B	1086
TCLNL16-3D	1086
TCLNL16-4D	1086
TCLNL16-4D-CH	1111
TCLNL16-5D	1086
TCLNL16-6D	1086
TCLNL20-4D	1086
TCLNL20-5D	1086
TCLNL20-6D	1086
TCLNL24-4D	1086
TCLNL24-5D	1086
TCLNL24-6D	1086
TCLNR12-3B	1086
TCLNR12-4B	1086
TCLNR16-3D	1086

Designation	Page
TCLNR16-4D	1086
TCLNR16-4D-CH	1111
TCLNR16-5D	1086
TCLNR16-6D	1086
TCLNR20-4D	1086
TCLNR20-4D-CH	1111
TCLNR20-5D	1086
TCLNR20-6D	1086
TCLNR24-4D	1086
TCLNR24-5D	1086
TCLNR24-6D	1086
TCMNN12-4B	1088
TCMNN16-4D	1088
TCMNN20-6D	1088
TCMT090204MT	979
TCMT090208FG	978
TCMT090208MT	979
TCMT110204FG	978
TCMT110204MT	979
TCMT110208FG	978
TCMT110208MT	979
TCMT16T304FG	978
TCMT16T304MT	979
TCMT16T308FG	978
TCMT16T308MT	979
TCMT16T312MT	979
TCMT21.51FG	978
TCMT21.51MT	979
TCMT21.52FG	978
TCMT21.52MT	979
TCMT32.51FG	978
TCMT32.51MT	979
TCMT32.52FG	978
TCMT32.52MT	979
TCMT32.53MT	979
TCMT731MT	979
TCMT732FG	978
TCMT732MT	979
TCRNL12-4B	1089
TCRNL16-4D	1089
TCRNL20-4D	1089
TCRNR12-4B	1089
TCRNR16-4D	1089
TCRNR20-4D	1089
TD10P	287
TD-10P	288
TD15P	287
TD-15P	288
TD9P	1380
TDA6.00-3.00	1291
TDA8.00-4.00	1291
TDC2	1278
TDC2-15L	1278
TDC2-15LS	1278
TDC2-15R	1278
TDC2-15RS	1278
TDC2-6L	1278
TDC2-6R	1278
TDC2-8L	1278
TDC2-8R	1278
TDC3	1278
TDC3-15L	1278
TDC3-15LS	1278
TDC3-15R	1278
TDC3-15RS	1278
TDC3-6L	1278
TDC3-6R	1278
TDC3-6RS	1278
TDC4	1278
TDC4-15L	1278
TDC4-15R	1278
TDC4-4L	1278
TDC4-4R	1278
TDC5	1278
TDC5-4L	1278
TDC5-4R	1278
TDC6	1278

Designation	Page
TDC8	1278
TDF3E-0.4L	1287
TDF3E-0.4R	1287
TDF4E-0.4L	1287
TDF4E-0.4R	1287
TDF4E-0.4TLCE	1287
TDF4E-0.4TRCE	1287
TDIT3.00E-0.40	1289
TDIT3.00E-1.50	1290
TDIT3E-0.4	1289
TDIT4.00E-0.40	1289
TDIT4.00E-0.80	1289
TDIT4.00E-2.00	1290
TDIT4E-0.4	1289
TDIT4E-0.4TCE	1290
TDIT5.00E-0.40	1289
TDIT5.00E-0.80	1289
TDIT5.00E-2.50	1290
TDIT6.00E-0.80	1289
TDIT6.00E-1.20	1289
TDIT6.00E-3.00	1290
TDIT6E-0.8TCE	1290
TDIT8.00E-0.80	1289
TDIT8.00E-1.20	1289
TDJ1.4	1274
TDJ2	1274
TDJ2-15L	1274
TDJ2-15LS	1274
TDJ2-15R	1274
TDJ2-15RS	1274
TDJ2-6L	1274
TDJ2-6R	1274
TDJ3	1274
TDJ3-15L	1274
TDJ3-15LS	1274
TDJ3-15R	1274
TDJ3-15RS	1274
TDJ3-6L	1274
TDJ3-6R	1274
TDJ4	1274
TDJ4-4L	1274
TDJ4-4R	1274
TDJ5	1274
TDJ5-4L	1274
TDJ5-4R	1274
TDJ6	1274
TDJNL12-3B	1090
TDJNL12-44B	1090
TDJNL12-4B	1090
TDJNL16-3D	1090
TDJNL16-44D	1090
TDJNL16-4D	1090
TDJNL16-4D-CH	1112
TDJNL20-4D	1090
TDJNR12-3B	1090
TDJNR12-44B	1090
TDJNR12-4B	1090
TDJNR16-3D	1090
TDJNR16-44D	1090
TDJNR16-4D	1090
TDJNR16-4D-CH	1112
TDJNR20-4D	1090
TDNNN16-4D	1091
TDQNL16-4D	1091
TDQNR16-4D	1091
TD1.00-0.00	1288
TD1.30-0.00	1288
TD1.60-0.10	1288
TD1.85-0.10	1288
TD2.15-0.15	1288
TD2.39-0.18	1288
TD2.65-0.15	1288
TD3.00E-0.20	1282
TD3.00E-0.40	1282
TD3.00E-1.50	1286
TD3.15-0.15	1288
TD3.18E-0.18	1282

INDEX

Designation	Page	Designation	Page	Designation	Page
TDT3.18E-0.40	1282	TGBFR32T32-80-180-6	1307	TGIUR38.1-6-15A	1328
TDT3E-0.4	1284	TGBFR32T35-130-250-5	1307	TGIUR38.1-8-15A	1328
TDT3E-1.5RU	1285	TGBFR32T35-85-140-5	1307	TGIUR40-6C-15A	1329
TDT4.00E-0.40	1282	TGBFR32T38-168-300-6	1307	TGIUR40-8C-15A	1329
TDT4.00E-0.80	1282	TGBL32T24-2	1306	TGIUR50-6C-15A	1329
TDT4.00E-2.00	1286	TGBL32T33-3	1306	TGTEL12.7-3D-SH	1341
TDT4.15-0.15	1288	TGBL32T41-4	1306	TGTEL15.9-3D-SH	1341
TDT4.75E-0.40	1282	TGBR32T24-2	1306	TGTEL19-4-33	1340
TDT4.78E-0.55	1282	TGBR32T33-3	1306	TGTEL25.4-4-20	1340
TDT4.78E-2.39	1286	TGBR32T41-4	1306	TGTEL9.5-3C-SH	1341
TDT4E-0.4	1284	TGEL12.7-2	1310	TGTER1010K16-SH	1341
TDT4E-0.4TCE	1285	TGEL12.7-3	1310	TGTER12.7-3D-SH	1341
TDT4E-2.0RU	1285	TGEL1212-2	1310	TGTER1212M16-SH	1341
TDT5.00E-0.40	1282	TGEL1212-3	1310	TGTER15.9-3D-SH	1341
TDT5.00E-0.80	1282	TGEL1616-2	1310	TGTER1616H16	1341
TDT5.00E-2.50	1286	TGEL1616-3	1310	TGTER1616M16-SH	1341
TDT5.15-0.15	1288	TGEL19-2	1310	TGTER19-4-20	1340
TDT5E-2.5RU	1285	TGEL19-3	1310	TGTER19-4-33	1340
TDT6.00E-0.40	1282	TGEL19-4	1310	TGTER2020K16	1341
TDT6.00E-0.80	1282	TGEL25.4-3	1310	TGTER2020K22-23	1341
TDT6.00E-1.20	1282	TGEL25.4-4	1310	TGTER2020K22-33	1341
TDT6.00E-3.00	1286	TGEL9.5-2	1310	TGTER25.4-4-20	1340
TDT6.35E-0.40	1282	TGER12.7-2	1310	TGTER25.4-4-33	1340
TDT6E-0.8TCE	1285	TGER12.7-3	1310	TGTER2525M16	1341
TDT6E-3.0RU	1285	TGER1212-2	1310	TGTER2525M22-23	1341
TDT8.00E-0.80	1282	TGER1212-3	1310	TGTER9.5-3C-SH	1341
TDT8.00E-1.20	1282	TGER1616-2	1310	TGTIL31.7-4-33	1342
TDT8.00E-4.00	1286	TGER1616-3	1310	TGTIR31.7-4-33	1342
TDT8E-4.0RU	1285	TGER19-2	1310	TH101191	1331
TDXU3E-0.3	1281	TGER19-3	1310	TH101192	1331
TDXU4E-0.4	1281	TGER19-4	1310	TH101261	1331
TDXU5E-0.4	1281	TGER25.4-3	1310	TH101262	1331
TDXU6E-0.4	1281	TGER25.4-4	1310	TH101263	1331
TDXU8E-0.8	1281	TGER9.5-2	1310	TH101264	1331
TFLT15T303N	490	TGEUL19-3	1323	TH101265	1331
TFLT15T308N	490	TGEUL25.4-3	1323	TH101321	1331
TG1F-20R01	268	TGEUL25.4-6	1323	TH101322	1331
TG1F-30R01	268	TGEUR19-3	1323	TH101323	1331
TGB26-1.4S	1304	TGEUR19-4	1323	TH101324	1331
TGB26-2S	1304	TGEUR25.4-3	1323	TH101325	1331
TGB26-3S	1304	TGEUR25.4-6	1323	TH101326	1331
TGB26-4S	1304	TGFL19-4	1322	THL201062	1332
TGB32-1.4	1304	TGFL19-6	1322	THL201083	1332
TGB32-2	1304	TGFL25.4-4	1322	THL201102	1332
TGB32-3	1304	TGFPL25.4-4	1322	THL201103	1332
TGB32-4	1304	TGFPL31.8-4	1322	THL201104	1332
TGB32-5	1304	TGFPR25.4-6	1322	THL201122	1332
TGB32-6	1304	TGFPR31.8-4	1322	THL201123	1332
TGB32-8S-CL	1305	TGFR19-4	1322	THL201124	1332
TGB45-4	1305	TGFR25.4-4	1322	THL201125	1332
TGB45-4-L	1305	TGFR25.4-6	1322	THL201163	1332
TGB5-22-2-MS	1308	TGH-MPI	1384	THL201164	1332
TGB5-22-3-MS	1308	TGH-MPI-25	1384	THL201165	1332
TGB5-22-4-MS	1308	TGH-MPS	1384	THL201166	1332
TGB52-8-CL	1306	TGH-MPS-25	1384	THL201204	1332
TGBFL32T20-40-60-3	1307	TGHR19.05-D15.88	1384	THL201206	1332
TGBFL32T20-54-80-3	1307	TGHR25.4-D15.88	1384	THL211062	1334
TGBFL32T25-114-180-3	1307	TGHR25.4-D25.4	1384	THL211063	1334
TGBFL32T25-40-60-4	1307	TGHR-D16-BL	1384	THL211082	1334
TGBFL32T25-50-80-4	1307	TGHR-D25-BL	1384	THL211103	1334
TGBFL32T25-74-120-3	1307	TGHR-WD	1384	THL211123	1334
TGBFL32T30-120-200-4	1307	TGHR-WD-25	1384	THL211124	1334
TGBFL32T30-70-130-4	1307	TGH-WS	1384	THL211163	1334
TGBFL32T32-60-95-5	1307	TGH-WS-25	1384	THL211164	1334
TGBFL32T32-80-180-6	1307	TGIUL19-3	1328	THL211165	1334
TGBFL32T35-130-250-5	1307	TGIUL25.4-3	1328	THL211166	1334
TGBFL32T35-85-140-5	1307	TGIUL25.4-4	1328	THL211203	1334
TGBFL32T38-168-300-6	1307	TGIUL25.4-6	1328	THL211204	1334
TGBFR32T20-40-60-3	1307	TGIUL38.1-6-15A	1328	THL211205	1334
TGBFR32T20-54-80-3	1307	TGIUL38.1-8-15A	1328	THL211206	1334
TGBFR32T25-114-180-3	1307	TGIUL40-6C-15A	1329	THL61916C078	1336
TGBFR32T25-40-60-4	1307	TGIUL50-6C-15A	1329	THL61916C118	1336
TGBFR32T25-50-80-4	1307	TGIUL50-8C-15A	1329	THL61920C078	1336
TGBFR32T25-74-120-3	1307	TGIUR19-3	1328	THL61920C118	1336
TGBFR32T30-120-200-4	1307	TGIUR25.4-3	1328	THL61920C197	1336
TGBFR32T30-70-130-4	1307	TGIUR25.4-4	1328	THL61924C078	1336
TGBFR32T32-60-95-5	1307	TGIUR25.4-6	1328	THL61924C118	1336

Designation	Page
THL61924C157	1336
THL61924C236	1336
THR201062	1332
THR201082	1332
THR201083	1332
THR201102	1332
THR201103	1332
THR201122	1332
THR201123	1332
THR201124	1332
THR201125	1332
THR201163	1332
THR201164	1332
THR201165	1332
THR201166	1332
THR201203	1332
THR201204	1332
THR201206	1332
THR211062	1334
THR211063	1334
THR211082	1334
THR211083	1334
THR211103	1334
THR211104	1334
THR211123	1334
THR211124	1334
THR211163	1334
THR211164	1334
THR211165	1334
THR211166	1334
THR211203	1334
THR211204	1334
THR211205	1334
THR61916C078	1336
THR61916C118	1336
THR61916C157	1336
THR61920C118	1336
THR61920C157	1336
THR61920C197	1336
THR61924C078	1336
THR61924C118	1336
THR61924C157	1336
THR61924C197	1336
THR61924C236	1336
THSNL12-4B	1092
THSNL16-4D	1092
THSNL16-6D	1092
THSNL20-4D	1092
THSNL20-6D	1092
THSNL24-6E	1092
THSNR12-4B	1092
THSNR16-4D	1092
THSNR16-6D	1092
THSNR20-4D	1092
THSNR20-6D	1092
THSNR24-6E	1092
TIMC1.6	1292
TIMC1.66R	1292
TIMC2	1292
TIMC2.4	1292
TIMC2.46L	1292
TIMC2.46R	1292
TIMC26R	1292
TIMC3	1292
TIMC36L	1292
TIMC36R	1292
TIMC4	1292
TIMC4.8	1292
TIMC4.86L	1292
TIMC4.86R	1292
TIMC46L	1292
TIMC46R	1292
TIMC5	1292
TIMC56L	1292
TIMC56R	1292
TIMC6	1292
TIMC66L	1292

Designation	Page
TIMC66R	1292
TIMJ2	1294
TIMJ2.4	1294
TIMJ2.46L	1294
TIMJ2.46R	1294
TIMJ26L	1294
TIMJ26R	1294
TIMJ3	1294
TIMJ36L	1294
TIMJ36R	1294
TIMJ4	1294
TIMJ4.8	1294
TIMJ4.86L	1294
TIMJ4.86R	1294
TIMJ46L	1294
TIMJ46R	1294
TIMJ5	1294
TIMJ56L	1294
TIMJ56R	1294
TIPV.090E.007	1296
TIPV.130E.007	1296
TIPV.130E.065	1296
TIPV.170E.015	1296
TIPV.170E.085	1296
TIPV.210E.024	1296
TIPV.210E.105	1296
TIPV.255E.024	1296
TIPV.255E.127	1296
TIPV3.00E0.40	1295
TIPV3.00E1.50	1295
TIPV4.00E0.40	1295
TIPV4.00E2.00	1295
TIPV4.50E0.40	1295
TIPV5.00E0.40	1295
TIPV5.00E2.50	1295
TIPV6.00E0.40	1295
TIPV6.00E3.00	1295
TJ5N-20R01	120
TJ5N-25R01	120
TJ5N-30R01	120
TJ5N-40R01	120
TJ5N-50R01	120
TJ5N-60R01	120
TJ5N-80R01	120
TJ6N-20R01	120
TJ6N-30R01	120
TJ6N-40R01	120
TJ6N-50R01	120
TJ6N-60R01	120
TKDCM-10	499
TKDCM-11	499
TKDCM-12	493
TKDCM-13	499
TKDCM-14	499
TKDCM-15	499
TKDCM-16	493
TKDCM-17	499
TKDCM-18	499
TKDCM-19	499
TKDCM-20	499
TKDCM-21	499
TKDCM-22	499
TKDCM-23	499
TKDCM-24	499
TKDCM-25	499
TKDCM-8	499
TKDCM-9	499
TM-B5-KEY	542
TM-B5-SCR	542
TM-B6-KEY	542
TM-B6-SC	542
TM-B6-SCR	542
TM-B7-KEY	542
TM-B7-SCR	542
TM-B8-KEY	542
TM-B8-SCR	542
TM-B9-KEY	542

Designation	Page
TM-B9-SCR	542
TN_22_	1058
TN_33_	1056
TN_43_	1056
TN_54_	1057
TN_66_	1058
TN1N-20R01	183
TN1N-30R01	183
TN1N-30R02	183
TN1N-40R01	183
TN1N-40R02	183
TN1N-60R01	183
TNG33_	1110
TNG331	1004
TNG332	1004
TNG332E	1004
TNG333	1004
TNG351	1004
TNG352	1004
TNGA160404	1003
TNGA160408	1003
TNGA160408E	1003
TNGA160412	1003
TNGA220408	1003
TNGA331	1003
TNGA332	1003
TNGA332E	1003
TNGA333	1003
TNGA432	1003
TNGG160404L	932
TNGG160404R	932
TNGG160408L	932
TNGG160408R	932
TNGG220404L	932
TNGG220404R	932
TNGG220408L	932
TNGG220408R	932
TNGG331L	932
TNGG331R	932
TNGG332L	932
TNGG332R	932
TNGG431L	932
TNGG431R	932
TNGG432L	932
TNGG432R	932
TNGN 160404	1004
TNGN 160408	1004
TNGN160408E	1004
TNGN160412	1004
TNGN160704	1004
TNGN160708	1004
TNGU2207PNTN	132
TNMA110304	933
TNMA160404	933
TNMA160404LN	1015
TNMA160404LN-10	1021
TNMA160404LS	1015
TNMA160408	933
TNMA160408LN	1015
TNMA160408LN-10	1021
TNMA160408LS	1015
TNMA160408LS3	1015
TNMA160412	933
TNMA160416	933
TNMA220404	933
TNMA220408	933
TNMA220408LS	1015
TNMA220412	933
TNMA221	933
TNMA331	933
TNMA331LN	1015
TNMA331LN-10	1021
TNMA331LS	1015
TNMA332	933
TNMA332LN	1015
TNMA332LN-10	1021
TNMA332LS	1015

INDEX

Designation	Page	Designation	Page	Designation	Page
TNMA332LS3	1015	TNMG331	934	TOOL CLAMP 50 ROTARY	868
TNMA333	933	TNMG331FC	935	TP_22_	1045
TNMA334	933	TNMG331FG	936	TP_32_	1045
TNMA431	933	TNMG331L-FS	937	TP_43_	1045
TNMA432	933	TNMG331L-VF	943	TP_T21.5_	1132
TNMA432LS	1015	TNMG331ML	938	TPG220.5LN-7	1021
TNMA433	933	TNMG331MP	939	TPG220430	980
TNMG110304	934	TNMG331MT	940	TPG221	980
TNMG110304FG	936	TNMG331PC	941	TPG221LN-7	1021
TNMG110308	934	TNMG331R-FS	937	TPG221LS	1015
TNMG110308MT	940	TNMG331R-VF	943	TPG222	980
TNMG160308FG	936	TNMG332	934	TPG222LN-7	1021
TNMG160404	934	TNMG332CE	1004	TPG222LS	1015
TNMG160404FC	935	TNMG332FC	935	TPG320.5	980
TNMG160404FG	936	TNMG332FG	936	TPG320.5LN-7	1021
TNMG160404L-FS	937	TNMG332L-FS	937	TPG321	980
TNMG160404L-VF	943	TNMG332L-VF	943	TPG321LN-7	1021
TNMG160404ML	938	TNMG332MC	937	TPG321LS	1015
TNMG160404MP	939	TNMG332ML	938	TPG322	980
TNMG160404MT	940	TNMG332MP	939	TPG322LN-7	1021
TNMG160404PC	941	TNMG332MT	940	TPG322LS	1015
TNMG160404R-FS	937	TNMG332PC	941	TPG323	980
TNMG160404R-VF	943	TNMG332R-FS	937	TPG431	980
TNMG160408	934	TNMG332RT	942	TPG432	980
TNMG160408CE	1004	TNMG332R-VF	943	TPG432LS	1015
TNMG160408FC	935	TNMG332SF	943	TPG433	980
TNMG160408FG	936	TNMG333	934	TPG434	980
TNMG160408L-FS	937	TNMG333FC	935	TPG436	980
TNMG160408L-VF	943	TNMG333FG	936	TPG438	980
TNMG160408MC	937	TNMG333ML	938	TPG542	980
TNMG160408ML	938	TNMG333MP	939	TPGN 110304	1005
TNMG160408MP	939	TNMG333MT	940	TPGN 110308	1005
TNMG160408MT	940	TNMG333PC	941	TPGN 160304	1005
TNMG160408PC	941	TNMG333RT	942	TPGN 160308	1005
TNMG160408R-FS	937	TNMG431	934	TPGN 110304	980
TNMG160408RT	942	TNMG431ML	938	TPGN110304LN-7	1021
TNMG160408R-VF	943	TNMG431MP	939	TPGN110304LS	1015
TNMG160408SF	943	TNMG431MT	940	TPGN110308	980
TNMG160412	934	TNMG431R-FS	937	TPGN110308LN-7	1021
TNMG160412FC	935	TNMG432	934	TPGN110308LS	1015
TNMG160412FG	936	TNMG432FG	936	TPGN160302	980
TNMG160412ML	938	TNMG432ML	938	TPGN160302LN-7	1021
TNMG160412MP	939	TNMG432MP	939	TPGN160304	980
TNMG160412MT	940	TNMG432MT	940	TPGN160304LN-7	1021
TNMG160412PC	941	TNMG432PC	941	TPGN160304LS	1015
TNMG160412RT	942	TNMG432RT	942	TPGN160308	980
TNMG220404	934	TNMG433	934	TPGN160308LN-7	1021
TNMG220404ML	938	TNMG433MP	939	TPGN160308LS	1015
TNMG220404MP	939	TNMG433MT	940	TPGN160312	980
TNMG220404MT	940	TNMG433PC	941	TPGN220404	980
TNMG220404R-FS	937	TNMG433RT	942	TPGN220408	980
TNMG220408	934	TNMG434	934	TPGN220408LS	1015
TNMG220408FG	936	TNMG438	934	TPGN220412	980
TNMG220408ML	938	TNMG542	934	TPGN220416	980
TNMG220408MP	939	TNMG543	934	TPGN220425	980
TNMG220408MT	940	TNMG543MT	940	TPGN270608	980
TNMG220408PC	941	TNMG544	934	TPGT090204L-C	981
TNMG220408RT	942	TNMG654	934	TPGT110304L-C	981
TNMG220412	934	TNMG666	934	TPGT110304R-C	981
TNMG220412MP	939	TNMG666RT	942	TPGT110308L-C	981
TNMG220412MT	940	TNMM160408RH	944	TPGT160404L-C	981
TNMG220412PC	941	TNMM160412RH	944	TPGT160404R-C	981
TNMG220412RT	942	TNMM220408RH	944	TPGT221L-C	981
TNMG220416	934	TNMM220412RH	944	TPGT221R-C	981
TNMG220432	934	TNMM220416RH	944	TPGT222L-C	981
TNMG221	934	TNMM270612RH	944	TPGT331L-C	981
TNMG221FG	936	TNMM332RH	944	TPGT331R-C	981
TNMG222	934	TNMM333RH	944	TPGT731L-C	981
TNMG222MT	940	TNMM432RH	944	TPGX090202L	982
TNMG270608	934	TNMM433RH	944	TPGX090204L	982
TNMG270612	934	TNMM434RH	944	TPGX110302L	982
TNMG270612MT	940	TNMM543RH	944	TPGX110302R	982
TNMG270616	934	TOOL CLAMP 30 FIX	868	TPGX110304L	982
TNMG322FG	936	TOOL CLAMP 30 ROTARY	868	TPGX110304R	982
TNMG330716	934	TOOL CLAMP 40 FIX	868	TPGX220.5L	982
TNMG330924	934	TOOL CLAMP 40 ROTARY	868	TPGX220.5R	982
TNMG330924RT	942	TOOL CLAMP 50 FIX	868	TPGX221L	982

Designation	Page
TPGX221R	982
TPGX730.5L	982
TPGX731L	982
TPMR090204	983
TPMR090208	983
TPMR110304	983
TPMR110308	983
TPMR160304	983
TPMR160308	983
TPMR160312	983
TPMR220404	983
TPMR220408	983
TPMR220412	983
TPMR221	983
TPMR222	983
TPMR321	983
TPMR322	983
TPMR323	983
TPMR431	983
TPMR432	983
TPMR433	983
TPMR731	983
TPMR732	983
TPMT110204PC	984
TPMT110208PC	984
TPMT110304FG	984
TPMT16T304PC	984
TPMT16T308PC	984
TPMT21.51PC	984
TPMT21.52PC	984
TPMT221FG	984
TPMT32.51PC	984
TPMT32.52PC	984
TPMX 1403LG	641
TPMX 1403RB	593
TPMX 1403RG	593
TPMX 16-TDM	628
TPMX 1704LG	641
TPMX 1704RB	593
TPMX 1704RG	593
TPMX 22-TDM	628
TPMX 2405L	649
TPMX 2405LG	641
TPMX 2405RB	593
TPMX 2405RG	593
TPMX 2807RB	593
TPMX 2807RG	593
TPMX1403 LG	642
TPMX1403 RG	642
TPMX16-TDM	629
TPMX1704 LG	642
TPMX1704 RG	642
TPMX22-TDM	629
TPMX2405 LG	642
TPMX2405 RG	642
TPU110308	985
TPU221	985
TPU222	985
TPU321	985
TPU322	985
TPU323	985
TPU324	985
TPU431	985
TPU432	985
TPU433	985
TPU434	985
TPUN110304	985
TPUN160304	985
TPUN160308	985
TPUN160312	985
TPUN160316	985
TPUN220404	985
TPUN220408	985
TPUN220412	985
TPUN220416	985
TS-10	1044
TS18034I/HG-P	1380

Designation	Page
TS20038I/HG-P	1380
TS22052I/HG-P	1380
TS-25.45-6M1	1067
TS25064I/HG-P	1380
TS30100I/HG-P	1380
TS35088I/HG-P	1380
TS-4	1045
TS-4.7-10M1	1065
TS-4.7-8M1	1126
TS40E113/HG	1341
TS40E113I/HG	1341
TS-44-2	1044
TS-44-3M	1132
TS45A100I/HG	1380
TS-5.8-10M1	1065
TS-6	1045
TS60190I	1311
TSA6.00-3.00	1291
TSA8.00-4.00	1291
TSC10.2361.500K	206
TSC2	1280
TSC2-15L	1280
TSC2-15LS	1280
TSC2-15R	1280
TSC2-15RS	1280
TSC2-6L	1280
TSC2-6R	1280
TSC2-8L	1280
TSC2-8R	1280
TSC3	1280
TSC3.0631.000A	207
TSC3.0871.000A	207
TSC3-15L	1280
TSC3-15LS	1280
TSC3-15R	1280
TSC3-15RS	1280
TSC3-6L	1280
TSC3-6R	1280
TSC4	1085
TSC4.0631.000A	207
TSC4.1221.000K	206
TSC4.1881.000K	206
TSC4-15L	1280
TSC4-15R	1280
TSC44	1085
TSC4-4L	1280
TSC4-4R	1280
TSC5	1280
TSC5.1221.250K	206
TSC5.1881.250K	206
TSC54	1087
TSC5-4L	1280
TSC5-4R	1280
TSC6	1280
TSC6.1221.500K	206
TSC6.1881.500K	206
TSC6.2361.500K	206
TSC8.1221.500K	206
TSC8.1881.500K	206
TSC8.2361.500K	206
TSD43	1090
TSD44	1090
TSDNN12-4B	1094
TSDNN16-4D	1094
TSDNN20-4D	1094
TSDNN20-6D	1094
TSH42	1139
TSH44	1092
TSH64	1092
TSJ2	1276
TSJ2-15L	1276
TSJ2-15LS	1276
TSJ2-15R	1276
TSJ2-15RS	1276
TSJ2-6L	1276
TSJ2-6R	1276
TSJ3	1276

Designation	Page
TSJ3-15L	1276
TSJ3-15LS	1276
TSJ3-15R	1276
TSJ3-15RS	1276
TSJ3-6L	1276
TSJ3-6R	1276
TSJ4	1276
TSJ4-4L	1276
TSJ4-4R	1276
TSJ5	1276
TSJ5-4L	1276
TSJ5-4R	1276
TSJ6	1276
TSKNL16-4D	1095
TSKNR16-4D	1095
TSL15.88-12.7	1385
TSL15.88-9.52	1385
TSL19.05-10	1385
TSL19.05-12	1385
TSL25.4-10	1385
TSL25.4-12	1385
TSL25.4-16	1385
TSL25.4-19.05	1385
TSL25.4-20	1385
TSL31.75-10	1385
TSL31.75-12	1385
TSL31.75-16	1385
TSL31.75-20	1385
TSL31.75-25	1385
TSL38.1-10	1385
TSL38.1-12	1385
TSL38.1-16	1385
TSL38.1-20	1385
TSL38.1-25	1385
TSL50.8-25	1385
TSRNL16-4D	1096
TSRNL20-4D	1096
TSRNL20-5D	1096
TSRNL20-6D	1096
TSRNR16-4D	1096
TSRNR20-4D	1096
TSRNR20-5D	1096
TSRNR20-6D	1096
TSS44	1094
TSS54	1096
TSSNL16-4D	1097
TSSNL16-4D-CH	1113
TSSNL20-6D	1097
TSSNR16-4D	1097
TSSNR16-4D-CH	1113
TSSNR20-6D	1097
TST33	1098
TST43	1098
TSV33	1100
TSW44	1102
TT_43_	1098
TTBN_-26	1304
TTBN_-32	1304
TTBN19-26	1309
TTBN19-32	1309
TTBN25.4-32	1309
TTBN31.8-32	1309
TTBU_-26	1304
TTBU_-32	1304
TTBU_-45	1305
TTBU19-26	1309
TTBU19-32	1309
TTBU25.4-26	1309
TTBU25.4-32	1309
TTBU25.4-45	1309
TTBU31.8-32	1309
TTEL10-20-1.4SH	1320
TTEL10-20-2SH	1320
TTEL12.7-24-1.4SH	1320
TTEL12.7-24-2SH	1320
TTEL12.7-24-3SH	1320
TTEL12-24-2SH	1320

INDEX

Designation	Page
TTEL12-24-3SH	1320
TTEL14-24-1.4SH	1320
TTEL14-24-2SH	1320
TTEL15.9-2T17	1319
TTEL15.9-32-2SH	1320
TTEL15.9-32-3SH	1320
TTEL15.9-3T20	1319
TTEL1616-2	1318
TTEL1616-3	1318
TTEL16-32-1.4SH	1320
TTEL16-32-2SH	1320
TTEL16-32-3SH	1320
TTEL19-2	1318
TTEL19-2T17	1319
TTEL19-3	1318
TTEL19-3T16	1319
TTEL19-3T20	1319
TTEL19-4	1318
TTEL19-4T10	1317
TTEL19-4T25	1319
TTEL19-5	1318
TTEL19-6	1318
TTEL25.4-2	1318
TTEL25.4-2T17	1319
TTEL25.4-3	1318
TTEL25.4-3T25	1319
TTEL25.4-4	1318
TTEL25.4-4T10	1317
TTEL25.4-4T25	1319
TTEL25.4-5	1318
TTEL25.4-5T32	1319
TTEL25.4-6	1318
TTEL25.4-6T32	1319
TTEL25.4-8	1318
TTEL2525-6-15A	1330
TTEL2525-8-15A	1330
TTEL31.8-3	1318
TTEL31.8-4	1318
TTEL31.8-8	1318
TTEL9.5-20-1.4SH	1320
TTEL9.5-20-2SH	1320
TTEL10-20-1.4SH	1320
TTEL10-20-2SH	1320
TTEL12.7-24-1.4SH	1320
TTEL12.7-24-2SH	1320
TTEL12.7-24-3SH	1320
TTEL12-24-1.4SH	1320
TTEL12-24-2SH	1320
TTEL12-24-3SH	1320
TTEL14-24-1.4SH	1320
TTEL14-24-2SH	1320
TTEL15.9-2T17	1319
TTEL15.9-32-2SH	1320
TTEL15.9-32-3SH	1320
TTEL15.9-3T20	1319
TTEL1616-2	1318
TTEL1616-2T08	1317
TTEL1616-3	1318
TTEL1616-3T09	1317
TTEL1616-4T10	1317
TTEL16-32-1.4SH	1320
TTEL16-32-2SH	1320
TTEL16-32-3SH	1320
TTEL19-2	1318
TTEL19-2T17	1319
TTEL19-3	1318
TTEL19-3T09	1317
TTEL19-3T16	1319
TTEL19-3T20	1319
TTEL19-4	1318
TTEL19-4T10	1317
TTEL19-4T25	1319
TTEL19-5	1318
TTEL19-5T12	1317
TTEL19-6	1318
TTEL19-6T12	1317
TTEL25.4-2	1318

Designation	Page
TTER25.4-2T17	1319
TTER25.4-3	1318
TTER25.4-3T09	1317
TTER25.4-3T25	1319
TTER25.4-4	1318
TTER25.4-4T10	1317
TTER25.4-4T25	1319
TTER25.4-5	1318
TTER25.4-5T12	1317
TTER25.4-5T32	1319
TTER25.4-6	1318
TTER25.4-6T12	1317
TTER25.4-6T32	1319
TTER25.4-8	1318
TTER2525-6-15A	1330
TTER2525-8-15A	1330
TTER31.8-3	1318
TTER31.8-4	1318
TTER31.8-5	1318
TTER31.8-6	1318
TTER31.8-8	1318
TTER9.5-20-1.4SH	1320
TTER9.5-20-2SH	1320
TTFL25.4-150-6	1324
TTFL25.4-30-3	1324
TTFL25.4-30-4	1324
TTFL25.4-35-3	1324
TTFL25.4-40-3	1324
TTFL25.4-40-4	1324
TTFL25.4-50-3	1324
TTFL25.4-50-4	1324
TTFL25.4-60-3	1324
TTFL25.4-60-4	1324
TTFL25.4-60-6	1324
TTFL25.4-85-6	1324
TTFNL12-3B	1098
TTFNL16-3D	1098
TTFNL16-4D	1098
TTFNR12-3B	1098
TTFNR16-3D	1098
TTFNR16-4D	1098
TTFPL25.4-150-6	1326
TTFPL25.4-30-3	1326
TTFPL25.4-30-4	1326
TTFPL25.4-35-3	1326
TTFPL25.4-40-3	1326
TTFPL25.4-50-3	1326
TTFPL25.4-50-4	1326
TTFPL25.4-60-3	1326
TTFPL25.4-60-4	1326
TTFPL25.4-60-6	1326
TTFPL25.4-85-6	1326
TTFPR25.4-150-6	1326
TTFPR25.4-30-3	1326
TTFPR25.4-30-4	1326
TTFPR25.4-35-3	1326
TTFPR25.4-40-3	1326
TTFPR25.4-40-4	1326
TTFPR25.4-50-3	1326
TTFPR25.4-50-4	1326
TTFPR25.4-60-3	1326
TTFPR25.4-60-4	1326
TTFPR25.4-60-6	1326
TTFPR25.4-85-6	1326
TTFR25.4-150-6	1324
TTFR25.4-30-3	1324
TTFR25.4-30-4	1324
TTFR25.4-35-3	1324
TTFR25.4-40-3	1324
TTFR25.4-40-4	1324
TTFR25.4-50-3	1324
TTFR25.4-50-4	1324
TTFR25.4-60-3	1324
TTFR25.4-60-4	1324
TTFR25.4-60-6	1324
TTFR25.4-85-6	1324
TIG 32L...	1341

Designation	Page
TIG 32R...	1341
TIG 43R (.050"~.070")	1341
TIG 43R (.050"~.070")	1341
TIG 43R (.080"~.100)	1341
TIG22125L	1338
TIG22125R	1338
TIG22150L	1338
TIG22150R	1338
TIG22185L	1338
TIG22185R	1338
TIG22200L	1338
TIG22200R	1338
TIG22250L	1338
TIG22250R	1338
TIG22300L	1338
TIG22300R	1338
TIG22330L	1338
TIG22330R	1338
TIG22350L	1338
TIG22350R	1338
TIG22400L	1338
TIG22400R	1338
TIG22430L	1338
TIG22430R	1338
TIG22470L	1338
TIG22470R	1338
TIG32L03007R05-C	1339
TIG32L05012R05-C	1339
TIG32L07520R10-C	1339
TIG32L10020R10-C	1339
TIG32L12520R10-C	1339
TIG32L15020R10-C	1339
TIG32L17520R10-C	1339
TIG32L20025R10-C	1339
TIG32L25025R10-C	1339
TIG32R03007R05-C	1339
TIG32R05012R05-C	1339
TIG32R07520R10-C	1339
TIG32R10020R10-C	1339
TIG32R12520R10-C	1339
TIG32R15020R10-C	1339
TIG32R17520R10-C	1339
TIG32R20025R10-C	1339
TIG32R25025R10-C	1339
TIG43L12535R20-C	1339
TIG43L15035R20-C	1339
TIG43L17535R20-C	1339
TIG43L20035R20-C	1339
TIG43L25040R30-C	1339
TIG43L30040R30-C	1339
TIG43L35050R30-C	1339
TIG43L40050R40-C	1339
TIG43R12535R20-C	1339
TIG43R15035R20-C	1339
TIG43R17535R20-C	1339
TIG43R20035R20-C	1339
TIG43R25040R30-C	1339
TIG43R30040R30-C	1339
TIG43R35050R30-C	1339
TIG43R40050R40-C	1339
TTIL16-2C	1327
TTIL19-3C	1327
TTIL19-4C	1327
TTIL25.4-3C	1327
TTIL25.4-4C	1327
TTIL25.4-5C	1327
TTIL31.7-4C	1327
TTIL31.7-5C	1327
TTIL31.7-6C	1327
TTIL31.7-8C	1327
TTIL38.1-8C	1327
TTIR16-2C	1327
TTIR19-2C	1327
TTIR19-3C	1327
TTIR19-4C	1327
TTIR25.4-2C	1327
TTIR25.4-3C	1327

Designation	Page
TTIR25.4-4C	1327
TTIR25.4-5C	1327
TTIR31.7-4C	1327
TTIR31.7-5C	1327
TTIR31.7-6C	1327
TTIR31.7-8C	1327
TTIR38.1-8C	1327
TTJNL12-3B	1099
TTJNL16-3D	1099
TTJNL16-4D	1099
TTJNL20-4D	1099
TTJNR12-3B	1099
TTJNR16-3D	1099
TTJNR16-4D	1099
TTJNR20-4D	1099
TVJNL12-3C	1100
TVJNL16-3D	1100
TVJNL20-3D	1100
TVJNR12-3C	1100
TVJNR16-3D	1100
TVJNR20-3D	1100
TWLNL10-3A	1102
TWLNL12-3B	1102
TWLNL12-4B	1102
TWLNL16-3D	1102
TWLNL16-4D	1102
TWLNL20-4D	1102
TWLN10-3A	1102
TWLN12-3B	1102
TWLN12-4B	1102
TWLN16-3D	1102
TWLN16-4D	1102
TWLN20-4D	1102
UHLD08T310R-M	263
UHLD130515R-MM	263
UNEU12	199
UNEU1205R	269
UNLU0603MOTR	266
UOMT0602TR	15
VB_T22_	1079
VB_T33_	1078
VBET1103003L-GW	986
VBET1103003R-GW	986
VBET110301L-GF	986
VBET110301R-GF	986
VBET110302L-GF	986
VBET110302R-GF	986
VBET110304L-GF	986
VBET110304R-GF	986
VBET220.5L-GF	986
VBET220.5R-GF	986
VBET220L-GF	986
VBET220R-GF	986
VBET221L-GF	986
VBET221R-GF	986
VBET22X0L-GW	986
VBET22X0R-GW	986
VBGW160402LN-7	1022
VBGW160404LN	1016
VBGW160404LN-7	1022
VBGW160404LS	1016
VBGW160408LN-7	1022
VBGW160408LS	1016
VBGW330.5LN-7	1022
VBGW331LN	1016
VBGW331LN-7	1022
VBGW331LS	1016
VBGW332LN-7	1022
VBGW332LS	1016
VBMT160404FG	988
VBMT160404MT	989
VBMT160408FA	987
VBMT160408FG	988
VBMT160408MT	989
VBMT160412MT	989
VBMT331FG	988
VBMT331MT	989

Designation	Page
VBMT332FA	987
VBMT332FG	988
VBMT332MT	989
VBMT333MT	989
VC_T22_	1135
VC_T33_	1134
VC_T22_	1134
VC_T33_	1134
VCGT110302FL	992
VCGT110304FL	992
VCGT160402FL	992
VCGT160404FL	992
VCGT160408FL	992
VCGT160412FL	992
VCGT220.5FL	992
VCGT22053OFL	992
VCGT221FL	992
VCGT330.5FL	992
VCGT331FL	992
VCGT332FL	992
VCGT333FL	992
VCGT43.57.5FL	992
VCGW160404LN-7	1022
VCGW331LN-7	1022
VHU-20015D1L01	300
VHU-20015D1R01	300
VHU-25015D1L01	300
VHU-25015D1R01	300
VHU-30020D3L01	300
VHU-30020D3R01	300
VHU-4001958L01	300
VHU-4001958R01	300
VHU-5001958L01	300
VHU-5001958R01	300
VHU-6001958L01	300
VHU-6001958R01	300
VK5V-02L01	152
VK5V-02L25	152
VK5V-02R01	152
VK5V-02R25	152
VK5V-03L01	152
VK5V-03R01	152
VK5V-04R01	152
VK5V-05R01	152
VK5V-06R01	152
VK6V-02L01	154
VK6V-02L02	156
VK6V-02L25	154
VK6V-02R01	154
VK6V-02R02	156
VK6V-02R25	154
VK6V-03L0	154
VK6V-03L02	156
VK6V-03R01	154
VK6V-03R02	156
VK6V-04L01	154
VK6V-04L02	156
VK6V-04R01	154
VK6V-04R02	156
VK6V-05L01	154
VK6V-05R01	154
VK6V-06L01	154
VK6V-06L02	156
VK6V-06R01	154
VK6V-06R02	156
VL6V-02R25	158
VL6V-03R01	158
VL6V-04R01	158
VL6V-05R01	158
VL6V-06R01	158
VL6V-08R01	158
VL6V-10R01	158
VL6V-12R01	158
VM2N-03L01	193
VM2N-03R01	193
VM2N-04L01	193
VM2N-04R01	193

Designation	Page
VM2N-06L01	193
VM2N-06R01	193
VM2N-08L01	193
VM2N-08R01	193
VM6V-02R25	192
VM6V-03R01	192
VM6V-04R01	192
VM6V-05R01	192
VM6V-06R01	192
VM6V-08R01	192
VM6V-10R01	192
VM6V-12R01	192
VN_2.53_	1133
VN_33_	1100
VN_43_	1062
VNGA160404	1005
VNGA160404LN	1016
VNGA160404LN-10	1023
VNGA160404LS	1016
VNGA160408	1005
VNGA160408E	1005
VNGA160408LN	1016
VNGA160408LN-10	1023
VNGA160408LS	1016
VNGA160408LS2	1016
VNGA331	1005
VNGA331LN	1016
VNGA331LN-10	1023
VNGA331LS	1016
VNGA332	1005
VNGA332E	1005
VNGA332LN	1016
VNGA332LN-10	1023
VNGA332LS	1016
VNGA332LS2	1016
VNGG160401ML	944
VNGG160402ML	944
VNGG160404ML	944
VNGG160408ML	944
VNGG330.5ML	944
VNGG330ML	944
VNGG331ML	944
VNGG332ML	944
VNGX160712T7-CH	1006
VNGX353T7-CH	1006
VNMG130404FG	947
VNMG130404MT	948
VNMG130408FG	947
VNMG130408MT	948
VNMG160404	945
VNMG160404FC	946
VNMG160404FG	947
VNMG160404MT	948
VNMG160404PC	945
VNMG160408	945
VNMG160408FA	946
VNMG160408FC	946
VNMG160408FG	947
VNMG160408MT	948
VNMG160408PC	948
VNMG160412	945
VNMG2.531FG	947
VNMG2.531MT	948
VNMG2.532FG	947
VNMG2.532MT	948
VNMG220408	945
VNMG331	945
VNMG331FC	946
VNMG331FG	947
VNMG331MT	948
VNMG331PC	948
VNMG332	945
VNMG332FA	946
VNMG332FC	946
VNMG332FG	947
VNMG332MT	948
VNMG332PC	948

INDEX

Designation	Page
VNMG333	945
VNMG432	945
VNMM160404ML	949
VNMM160408ML	949
VNMM331ML	949
VNMM332ML	949
W050MOD06SA-22	730
W050MOD06SK-24	731
WA004-01	530
WA005-01	530
WA006-01	530
WB062MOD08SK-50	730
WB075MOD10SK-50	730
WB100MOD12SK-35	731
WB100T12SA-00	422
WB125MOD16SK-40	730
WB125T15SA-00	422
WB150T15SK-34	423
WN_33_	1063
WN_43_	1063
WNGA 080408	1006
WNGA 080412	1006
WNGA 080416	1006
WNGA080408T7-WZ	1007
WNGA080408WZ-LS3	1017
WNGA080412T7-WZ	1007
WNGA432	1006
WNGA432T7-WZ	1007
WNGA432WZ-LS3	1017
WNGA433	1006
WNGA433T7-WZ	1007
WNGA434	1006
WNMA060408	950
WNMA060412	950
WNMA080408	950
WNMA080412	950
WNMA080416	950
WNMA332	950
WNMA333	950
WNMA432	950
WNMA433	950
WNMA434	950
WNMG060404FG	953
WNMG060404MC	954
WNMG060404MT	957
WNMG060408FG	953
WNMG060408MC	954
WNMG060408MP	956
WNMG060408MT	957
WNMG060408PC	958
WNMG060408WT	960
WNMG060412MP	956
WNMG060412MT	957
WNMG060412PC	958
WNMG080404FC	952
WNMG080404FG	953
WNMG080404MP	956
WNMG080404MT	957
WNMG080408ET	951
WNMG080408FC	952
WNMG080408FG	953
WNMG080408MC	954
WNMG080408ML	955
WNMG080408MP	956
WNMG080408MT	957
WNMG080408PC	958
WNMG080408RT	959
WNMG080408WT	960
WNMG080412MC	954
WNMG080412ML	955
WNMG080412MP	956
WNMG080412MT	957
WNMG080412PC	958
WNMG080412RT	959
WNMG080412WT	960
WNMG080416PC	958
WNMG080416RT	959

Designation	Page
WNMG331FG	953
WNMG331MC	954
WNMG331MT	957
WNMG332FG	953
WNMG332MC	954
WNMG332MP	956
WNMG332MT	957
WNMG332PC	958
WNMG332WT	960
WNMG333MP	956
WNMG333MT	957
WNMG333PC	958
WNMG431FC	952
WNMG431FG	953
WNMG431MP	956
WNMG431MT	957
WNMG432ET	951
WNMG432FC	952
WNMG432FG	953
WNMG432MC	954
WNMG432ML	955
WNMG432MP	956
WNMG432MT	957
WNMG432PC	958
WNMG432RT	959
WNMG432WS	960
WNMG432WT	960
WNMG433MC	954
WNMG433ML	955
WNMG433MP	956
WNMG433MT	957
WNMG433PC	958
WNMG433RT	959
WNMG433WT	960
WNMG434PC	958
WNMG434RT	959
WRENCH COOL TUBE HSK 40	867
WRENCH COOL TUBE HSK 50	867
WRENCH COOL TUBE HSK 63	867
WRENCH COOL TUBE HSK 80	867
WRENCH COOL TUBE HSK100	867
WRENCH ER11	862
WRENCH ER11 MINI	862
WRENCH ER16	862
WRENCH ER16 MINI	862
WRENCH ER20	862
WRENCH ER20 MINI	862
WRENCH ER20 SHORT	862
WRENCH ER25	862
WRENCH ER25 MINI	862
WRENCH ER32	862
WRENCH ER32 SHORT	862
WRENCH ER40	862
WRENCH ER40 SHORT	862
WRENCH ER50	862
WS-0022	127
WS-0029	19
WS-0030	19
WS-0043	392
WS-0044	19
WS-0059	19
WS-0061	47
WSR 4	1384
XCGT040104LTA	1383
XCGT040104RTA	1383
XCGT050204TA	1383
XCGT060204TA	1383
XCGT070304TA	1383
XCGT080304TA	1383
XCGT10T304TA	1383
XCGT130404TA	1383
XCGT170508TA	1383
XCMT040104LTC	1382
XCMT040104RTC	1382
XCMT050204TC	1382
XCMT060204TC	1382
XCMT070304TC	1382

Designation	Page
XCMT080304TC	1382
XCMT10T304TC	1382
XCMT10T308TC	1382
XCMT130404 TC	1382
XCMT130404TC	1382
XCMT130408TC	1382
XCMT170508TC	1382
XEET250408R-P	58
XEET250408R-PWRWK	58
XEET25040XR-P	58
XEET250416R-P	58
XEET250424R-P	58
XEET250432R-P	58
XFEB330504R-P	61
XFEB330508R-P	61
XFEB330508R-PW	61
XFEB330516R-P	61
XFEB330516R-PW	61
XFEB330532R-P	61
XFEB330550L-P	61
XFEB330550R-P	61
XFEB330564R-P	61
XLB12000R71 IN2005	545
XLB12700R71 IN2005	544
XLB13000R71 IN2005	545
XLB13501R71 IN2005	545
XLB14000R71 IN2005	545
XLB15000R71 IN2005	545
XLB15875R71 IN2005	544
XLB16000R71 IN2005	545
XLB16001R71 IN2005	545
XLB17000R71 IN2005	545
XLB18000R71 IN2005	545
XLB19000R71 IN2005	545
XLB19050R71 IN2005	544
XLB20000R71 IN2005	545
XLB20001R71 IN2005	545
XLB21000R71 IN2005	545
XLB22000R71 IN2005	545
XLB22225R71 IN2005	544
XLB23000R71 IN2005	545
XLB24000R71 IN2005	545
XLB25000R71 IN2005	545
XLB25400R71 IN2005	544
XLB26000R71 IN2005	545
XLB27000R71 IN2005	545
XLB28000R71 IN2005	545
XLB29000R71 IN2005	545
XLB30000R71 IN2005	545
XLB31000R71 IN2005	545
XLB31750R71 IN2005	544
XLB32000R71 IN2005	545
XNS35	1119
XNS36	1050
XNS47	1117
XNS48	1050
XNS510	1051
XNS59	1052
XPET140405FR-P	55
XPET140408FR-P	55
XPET140408FR-PW	55
XPET140416FR-P	55
XPET140424FR-P	55
XPET140432FR-P	55
XPMT 16002-45	641
XPMT 16002UB	616
XPMT 18003UB	616
XPMT 21003UB	616
XPMT 25003UB	616
XS044133S6R01	542
XS044133T3R01	543
XS044222S6R01	542
XS044222T3R01	543
XS044355S6R01	542
XS044355T3R01	543
XS6053226S6R01	542
XS6053350S6R01	542

Designation	Page
XS6053540S6R01	542
XS6053540T3R01	543
XS6135057T3R01	543
XS6135089T3R01	543
XS7063278S7R01	542
XS7063433S7R01	542
XS7063670S7R01	542
XS7063670T4R01	543
XS7160070T4R01	543
XS7160110T4R01	543
XS8079331S7R01	542
XS8079531S7R01	542
XS8079841S7R01	542
XS8079841T4R01	543
XS8200084T4R01	543
XS8200135T4R01	543
XS9250076S9R01	542
XS9250127S9R01	542
XS9250127U7R01	543
XS9250203S9R01	542
XS9250203U7R01	543
XSA12700R71 IN2005	546
XSA15875R01 IN2005	546
XSA19050R01 IN2005	546
XSA22225R01 IN2005	546
XSA25400R01 IN2005	546
XSA31750R71 IN2005	546
YAB0680R01	512
YAB0750R01	512
YAB0760R01	512
YAB0770R01	512
YAB0780R01	512
YAB0790R01	512
YAB0800R01	512
YAB0810R01	512
YAB0820R01	512
YAB0830R01	512
YAB0840R01	512
YAB0850R01	512
YAB0860R01	512
YAB0870R01	512
YAB0880R01	512
YAB0890R01	512
YAB0900R01	512
YAB0910R01	512
YAB0920R01	512
YAB0930R01	512
YAB0940R01	512
YAB0950R01	512
YAB0960R01	512
YAB0970R01	512
YAB0980R01	512
YAB0990R01	512
YAB1000R01	512
YAB1010R01	512
YAB1020R01	512
YAB1030R01	512
YAB1040R01	512
YAB1050R01	512
YAB1060R01	512
YAB1070R01	512
YAB1080R01	512
YAB1090R01	512
YAB1100R01	513
YAB1110R01	513
YAB1120R01	513
YAB1130R01	513
YAB1140R01	513
YAB1150R01	513
YAB1160R01	513
YAB1170R01	513
YAB1180R01	513
YAB1190R01	513
YAB1200R01	493
YAB1210R01	513
YAB1220R01	513
YAB1230R01	513

Designation	Page
YAB1240R01	513
YAB1250R01	513
YAB1260R01	513
YAB1270R01	513
YAB1280R01	513
YAB1290R01	513
YAB1300R01	513
YAB1310R01	513
YAB1320R01	513
YAB1330R01	513
YAB1340R01	513
YAB1350R01	513
YAB1360R01	513
YAB1370R01	513
YAB1380R01	513
YAB1390R01	513
YAB1400R01	513
YAB1410R01	513
YAB1420R01	513
YAB1430R01	513
YAB1440R01	513
YAB1450R01	513
YAB1460R01	513
YAB1470R01	513
YAB1480R01	513
YAB1490R01	513
YAB1500R01	514
YAB1510R01	514
YAB1520R01	514
YAB1530R01	514
YAB1540R01	514
YAB1550R01	514
YAB1560R01	514
YAB1570R01	514
YAB1580R01	514
YAB1590R01	514
YAB1600R01	493
YAB1610R01	514
YAB1620R01	514
YAB1630R01	514
YAB1640R01	514
YAB1650R01	514
YAB1660R01	514
YAB1670R01	514
YAB1680R01	514
YAB1690R01	514
YAB1700R01	514
YAB1710R01	514
YAB1720R01	514
YAB1730R01	514
YAB1740R01	514
YAB1750R01	514
YAB1760R01	514
YAB1770R01	514
YAB1780R01	514
YAB1790R01	514
YAB1800R01	514
YAB1810R01	514
YAB1820R01	514
YAB1830R01	514
YAB1840R01	514
YAB1850R01	514
YAB1860R01	514
YAB1870R01	514
YAB1880R01	514
YAB1890R01	514
YAB1900R01	514
YAB1905R01	515
YAB1910R01	515
YAB1920R01	515
YAB1930R01	515
YAB1940R01	515
YAB1950R01	515
YAB1960R01	515
YAB1970R01	515
YAB1980R01	515
YAB1990R01	515

Designation	Page
YAB2000R01	515
YAB2010R01	515
YAB2020R01	515
YAB2030R01	515
YAB2040R01	515
YAB2050R01	515
YAB2060R01	515
YAB2070R01	515
YAB2080R01	515
YAB2090R01	515
YAB2100R01	515
YAB2110R01	515
YAB2120R01	515
YAB2130R01	515
YAB2140R01	515
YAB2150R01	515
YAB2160R01	515
YAB2170R01	515
YAB2180R01	515
YAB2190R01	515
YAB2200R01	515
YAB2210R01	515
YAB2220R01	515
YAB2222R01	515
YAB2230R01	515
YAB2240R01	515
YAB2250R01	515
YAB2260R01	515
YAB2270R01	515
YAB2280R01	515
YAB2290R01	516
YAB2300R01	516
YAB2310R01	516
YAB2320R01	516
YAB2330R01	516
YAB2340R01	516
YAB2350R01	516
YAB2360R01	516
YAB2370R01	516
YAB2380R01	516
YAB2390R01	516
YAB2400R01	516
YAB2410R01	516
YAB2420R01	516
YAB2430R01	516
YAB2440R01	516
YAB2450R01	516
YAB2460R01	516
YAB2470R01	516
YAB2480R01	516
YAB2490R01	516
YAB2500R01	516
YAB2510R01	516
YAB2520R01	516
YAB2530R01	516
YAB2540R01	516
YAB2550R01	516
YAB2560R01	516
YAB2570R01	516
YAB2580R01	516
YAB2590R01	516
YB1200006SSR01	493
YB1600008S7R01	493
YBB0680R0	512
YBB0750R01	512
YBB0760R01	512
YBB0770R01	512
YBB0780R01	512
YBB0790R01	512
YBB0800R01	512
YBB0810R01	512
YBB0820R01	512
YBB0830R01	512
YBB0840R01	512
YBB0850R01	512
YBB0860R01	512
YBB0870R01	512

INDEX

Designation	Page	Designation	Page	Designation	Page
YBB0880R01	512	YBB1650R01	514	YBB2400R01	516
YBB0890R01	512	YBB1660R01	514	YBB2410R01	516
YBB0900R01	512	YBB1670R01	514	YBB2420R01	516
YBB0910R01	512	YBB1680R01	514	YBB2430R01	516
YBB0920R01	512	YBB1690R01	514	YBB2440R01	516
YBB0930R01	512	YBB1700R01	514	YBB2450R01	516
YBB0940R01	512	YBB1710R01	514	YBB2460R01	516
YBB0950R01	512	YBB1720R01	514	YBB2470R01	516
YBB0960R01	512	YBB1730R01	514	YBB2480R01	516
YBB0970R01	512	YBB1740R01	514	YBB2490R01	516
YBB0980R01	512	YBB1750R01	514	YBB2500R01	516
YBB0990R01	512	YBB1760R01	514	YBB2510R01	516
YBB1000R01	512	YBB1770R01	514	YBB2520R01	516
YBB1010R01	512	YBB1780R01	514	YBB2530R01	516
YBB1020R01	512	YBB1790R01	514	YBB2540R01	516
YBB1030R01	512	YBB1800R01	514	YBB2550R01	516
YBB1040R01	512	YBB1810R01	514	YBB2560R01	516
YBB1050R01	512	YBB1820R01	514	YBB2570R01	516
YBB1060R01	512	YBB1830R01	514	YBB2580R01	516
YBB1070R01	512	YBB1840R01	514	YBB2590R01	516
YBB1080R01	512	YBB1850R01	514	YC0680021SKR00	508
YBB1090R01	512	YBB1860R01	514	YC0770025RHR01	508
YBB1100R01	513	YBB1870R01	514	YC0820025RHR01	508
YBB1110R01	513	YBB1880R01	514	YC0830026SKR00	508
YBB1120R01	513	YBB1890R01	514	YC0910026RHR01	508
YBB1130R01	513	YBB1900R01	514	YC1000030SKR00	508
YBB1140R01	513	YBB1905R01	515	YC1050026RHR01	508
YBB1150R01	513	YBB1910R01	515	YC1130026RHR0	508
YBB1160R01	513	YBB1920R01	515	YC1200035SMR00	508
YBB1170R01	513	YBB1930R01	515	YC1210026RHR01	508
YBB1180R01	513	YBB1940R01	515	YC1300026RHR01	508
YBB1190R01	513	YBB1950R01	515	YC1330030RJR01	508
YBB1200R01	513	YBB1960R01	515	YC1400039SPR00	508
YBB1210R01	513	YBB1970R01	515	YC1450030RJR01	508
YBB1220R01	513	YBB1980R01	515	YC1650035RJR01	508
YBB1230R01	513	YBB1990R01	515	YC1730035RLR0	508
YBB1240R01	513	YBB2000R01	515	YC1730042SRR00	508
YBB1250R01	513	YBB2010R01	515	YC1920041RLR01	508
YBB1260R01	513	YBB2020R01	515	YC2040041RLR01	508
YBB1270R01	513	YBB2030R01	515	YC2100048SSR00	508
YBB1280R01	513	YBB2040R01	515	YCB1200R01	493
YBB1290R01	513	YBB2050R01	515	YCB1600R01	493
YBB1300R01	513	YBB2060R01	515	YD0750022B9R0	498
YBB1310R01	513	YBB2070R01	515	YD0750026SDR00	504
YBB1320R01	513	YBB2080R01	515	YD0750037B9R01	500
YBB1330R01	513	YBB2090R01	515	YD0800024B9R01	498
YBB1340R01	513	YBB2100R01	515	YD0800028SDR00	504
YBB1350R01	513	YBB2110R01	515	YD0800040B9R01	500
YBB1360R01	513	YBB2120R01	515	YD0850025B9R01	498
YBB1370R01	513	YBB2130R01	515	YD0850029SER00	504
YBB1380R01	513	YBB2140R01	515	YD0850042B9R01	500
YBB1390R01	513	YBB2150R01	515	YD0900027B9R01	498
YBB1400R01	513	YBB2160R01	515	YD0900031SER00	504
YBB1410R01	513	YBB2170R01	515	YD0900045B9R01	500
YBB1420R01	513	YBB2180R01	515	YD0950028B9R01	498
YBB1430R01	513	YBB2190R01	515	YD0950033SFR00	504
YBB1440R01	513	YBB2200R01	515	YD0950047B9R01	500
YBB1450R01	513	YBB2210R01	515	YD1000	510
YBB1460R01	513	YBB2220R01	515	YD1000030C0R01	498
YBB1470R01	513	YBB2222R01	515	YD1000033SFR00	504
YBB1480R01	513	YBB2230R01	515	YD1000050C0R01	500
YBB1490R01	513	YBB2240R01	515	YD1000080C0R01	502
YBB1500R01	514	YBB2250R01	515	YD1050	510
YBB1510R01	514	YBB2260R01	515	YD1050031C0R01	498
YBB1520R01	514	YBB2270R01	515	YD1050034SGR00	504
YBB1530R01	514	YBB2280R01	515	YD1050052C0R01	500
YBB1540R01	514	YBB2290R01	516	YD1100	510
YBB1550R01	514	YBB2300R01	516	YD1100033C0R01	498
YBB1560R01	514	YBB2310R01	516	YD1100036SGR00	504
YBB1570R01	514	YBB2320R01	516	YD1100055C0R01	500
YBB1580R01	514	YBB2330R01	516	YD1100088C0R01	502
YBB1590R01	514	YBB2340R01	516	YD1150	510
YBB1600R01	514	YBB2350R01	516	YD1150034C0R01	498
YBB1610R01	514	YBB2360R01	516	YD1150038SHR00	504
YBB1620R01	514	YBB2370R01	516	YD1150057C0R01	500
YBB1630R01	514	YBB2380R01	516	YD1200	510
YBB1640R01	514	YBB2390R01	516	YD1200036C0R01	498

Designation	Page
YD1200042SHR00	504
YD1200060COR01	500
YD1200096COR01	502
YD1250	510
YD1250037COR01	498
YD1250042SJR00	504
YD1250062COR01	500
YD1300	510
YD1300039COR01	498
YD1300042SJR00	504
YD1300065COR01	500
YD1300104COR01	502
YD1350	510
YD1350040COR01	498
YD1350044SKR00	504
YD1350067COR01	500
YD1400	510
YD1400042COR01	498
YD1400048SKR00	504
YD1400070COR01	500
YD1400112COR01	502
YD1450	510
YD1450043COR01	498
YD1450050SLR00	504
YD1450072COR01	500
YD1500	510
YD150004518R01	498
YD1500052SLR00	504
YD150007518R01	500
YD150012018R01	502
YD1600	510

Designation	Page
YD160004818R01	498
YD1600052SMR00	504
YD160008018R01	500
YD160012818R01	502
YD1700	510
YD170005118R01	498
YD1700055SNR00	504
YD170008518R01	500
YD170013618R01	502
YD1800	510
YD1800054C8R01	498
YD1800060SPR00	504
YD1800090C8R01	500
YD1800144C8R01	502
YD1900	510
YD1900057C8R01	498
YD1900062SQR00	504
YD1900095C8R01	500
YD1900152C8R01	502
YD2000	510
YD2000060C8R01	498
YD2000066SRR00	504
YD2000100C8R01	500
YD2000160C8R01	502
YD2100063C8R01	498
YD2100105C8R01	500
YD2100168C8R01	502
YD2200066C8R01	498
YD2200110C8R01	500
YD2200176C8R01	502
YD2300069C8R01	498

Designation	Page
YD2300115C8R01	500
YD2300184C8R01	502
YD2400072C8R01	498
YD2400120C8R01	500
YD2400192C8R01	502
YD2500075C8R01	498
YD2500125C8R01	500
YD2500200C8R01	502
YNE324-100	153
YXM324L001	159
YXM434L001	159
Z4SM05SA-10	727
Z4SM07SA-10	727
Z4SM10SA-12	727
Z4Z4SA050	728
Z4Z4SA075	728
Z4Z4SA100	728
Z5SM07SA-12	727
Z5SM10SA-12	727
Z5SM12SA-12	727
Z5SM15SA-12	727
Z5Z4SA025	728
Z5Z4SA050	728
Z5Z4SA075	728
Z5Z4SA100	728
Z5Z5SA075	728
Z5Z5SA100	728
Z5Z5SA125	728
ZOMW090700R	511

© Ingersoll Cutting Tool Company, All Rights Reserved

As part of an ongoing effort to improve its products, Ingersoll Cutting Tool Company reserves the right to make changes to the content or descriptions in this publication without prior notice.

Ingersoll Cutting Tool Company assumes no responsibility for descriptions and information related to third-party products herein.

Technical data and performance-related information contained in this catalog is presented "as is". It is not intended to constitute a written contract of features and/or benefits and is not legally binding.

Stock status information may change without notice, contact Ingersoll Customer Service for up-to-date information.

Member IMC Group
Ingersoll
Cutting Tools

Marketing & Technology Centers

USA

Ingersoll Cutting Tools

845 South Lyford Road
Rockford, IL 61108-2749, USA
Tel.: +1-815-387-6600
Fax: +1-815-387-6968
E-Mail: info@ingersoll-imc.com
Internet: www.ingersoll-imc.com

Canada

Ingersoll Cutting Tools Canada

845 South Lyford Road
Rockford, IL 61108-2749, USA
Tel.: +1-800-892-6859
Fax: +1-815-227-6010

Mexico

**Ingersoll Cutting Tools de México
S.A. de C.V.**

Bldv. Cuauhtemoc, Num 2411,
Locales 6 y 7
Esquina Calle Manuel Perez Treviño
Fracc. Residencial los Pinos
Saltillo, Coahuila C.P. 25198, México
Tel: +1-844-485-3208
Tel: +1-844-485-3220

Germany - Headquarters

Ingersoll Werkzeuge GmbH

Kalteiche-Ring 21-25
35708 Haiger, Germany
Tel.: +49 (0)2773-742-0
Fax: +49 (0)2773-742-812/814
E-Mail: info@ingersoll-imc.de
Internet: www.ingersoll-imc.de

Germany - Southern Office

Ingersoll Werkzeuge GmbH

Florianstraße 17
71665 Vaihingen-Horrheim, Germany
Telefon: +49 (0)7042-8316-0
Telefax: +49 (0)7042-8316-26
E-Mail: horrheim@ingersoll-imc.de